

ベトナム共和国

ファンラン地区農業開発計画調査報告書

図面集

昭和47年3月

海外技術協力事業団

JICA LIBRARY



1042408[3]

ベトナム共和国

ファンラン地区農業開発計画調査報告書

図面集

国際協力事業団	
受入 月日 '84. 3. 9	123
登録No. 00035	80.7
	KE

昭和47年3月

海外技術協力事業団

PHAN RANG AGRICULTURAL DEVELOPMENT PROJECT

LIST OF DRAWINGS

NO.	DRAWING NO.	TITLE
PART-I OVERALL PLANNING		
1	I-1	GENERAL MAP
2	I-2	LAYOUT OF IRRIGATION CANALS (1)
3	I-3	LAYOUT OF IRRIGATION CANALS (2)
4	I-4	LAYOUT OF LATERALS (1)
5	I-5	LAYOUT OF LATERALS (2)
6	I-6	LAYOUT OF PILOT FARM
7	I-7	LAND USE MAP
8	I-8	SOIL MAP
9	I-9	LAND CAPABILITY MAP
10	I-10	LAYOUT OF THE SUGAR PLANT
11	I-11	FLOW DIAGRAM OF PLANTATION WHITE SUGAR PLANT
PART-II FEASIBILITY STUDY		
12	II-1	GENERAL MAP
13	II-2	LAYOUT OF IRRIGATION CANALS
14	II-3	LAYOUT OF LATERALS
15	II-4	PROFILE AND TYPICAL CROSS SECTION OF MAIN IRRIGATION CANAL, I-N, I-S

NO.	DRAWING NO.	TITLE
16	II-5	PROFILE AND TYPICAL CROSS SECTION OF MAIN IRRIGATION CANAL, II-N, II-S
17	II-6	PROFILE AND TYPICAL CROSS SECTION OF MAIN IRRIGATION CANAL, II-S
18	II-7	PROFILE AND TYPICAL CROSS SECTION OF MAIN IRRIGATION CANAL, III-M
19	II-8	PROFILE AND TYPICAL CROSS SECTION OF MAIN IRRIGATION CANAL, III-S
20	II-9	PROFILE AND TYPICAL CROSS SECTION OF MAIN IRRIGATION CANAL, III-E III-N
21	II-10	REGULATING RESERVOIR
22	II-11	NO.1 PUMPING STATION
23	II-12	NO.2 PUMPING STATION
24	II-13	NO.3 PUMPING STATION
25	II-14	INTAKE STRUCTURE ON THE SONG LU
26	II-15	TYPICAL TURNOUT
27	II-16	TYPICAL CHECK GATE
28	II-17	TYPICAL CHECK GATE AND SPILLWAY
29	II-18	TYPICAL SIPHON
30	II-19	TYPICAL CULVERT, BRIDGE AND TYPICAL CROSS SECTION OF MAIN FARM ROAD
31	II-20	TYPICAL CROSS DRAIN AND INLET DRAIN
32	II-21	TYPICAL SIDE SPILLWAY
33	II-22	TYPICAL FIELD LAYOUT

全体計画編

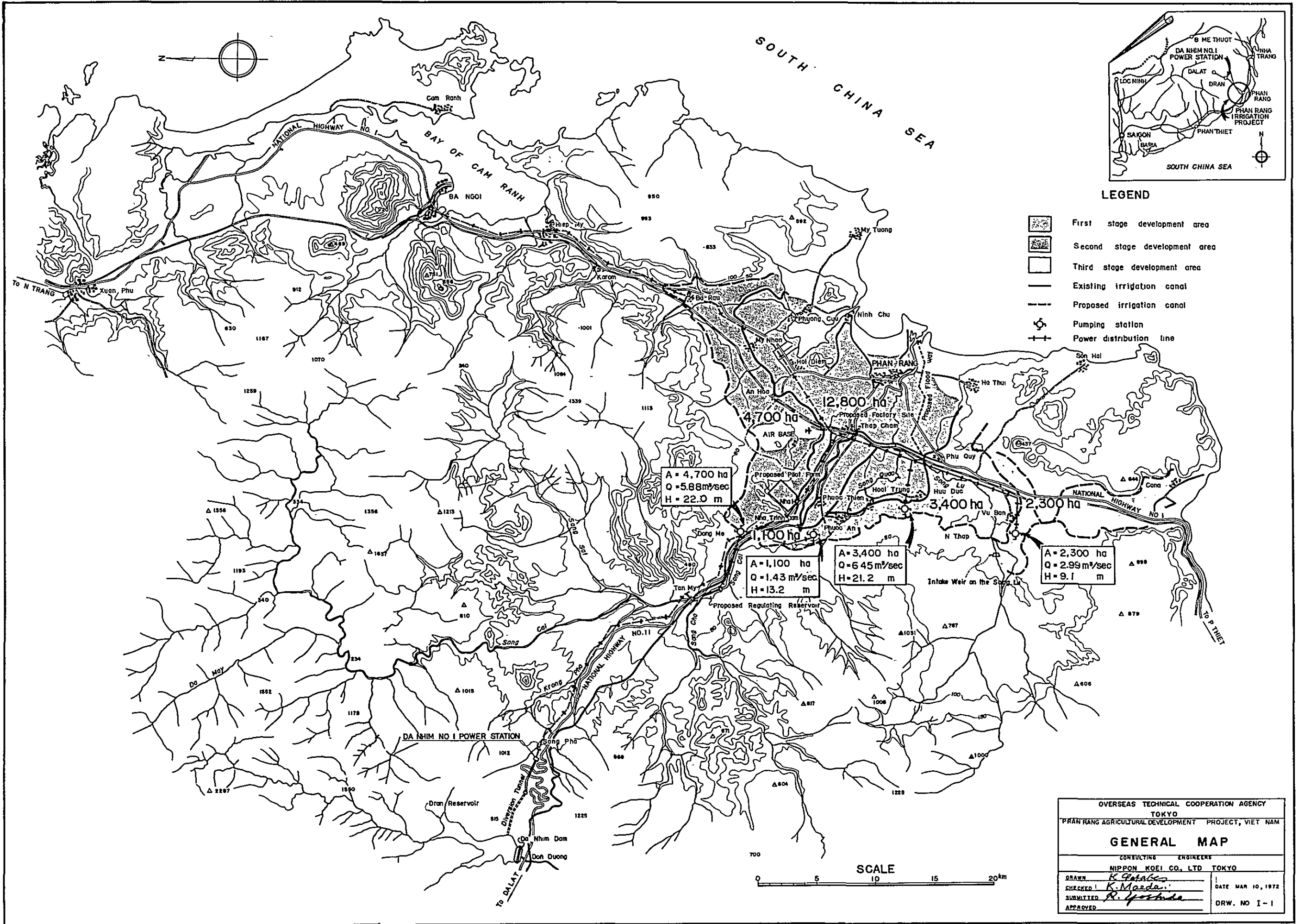

SOUTH CHINA SEA

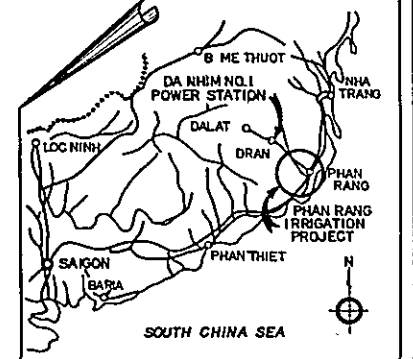
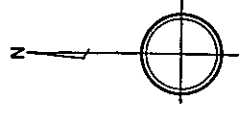

A = 4,700 ha
Q = 5.88 m³/sec
H = 22.0 m

A = 1,100 ha
Q = 1.43 m³/sec
H = 13.2 m

A = 3,400 ha
Q = 6.45 m³/sec
H = 21.2 m

A = 2,300 ha
Q = 2.99 m³/sec
H = 9.1 m

4,700 ha
12,800 ha
3,400 ha
2,300 ha

DA NHIM NO 1 POWER STATION

Dran Reservoir

Intake Weir on the Song Lu

Proposed Regulating Reservoir

Proposed Factory Site

AIR BASE

Proposed Pilot Farm

Proposed Regulating Reservoir

Proposed Regulating Reservoir

Proposed Regulating Reservoir

Proposed Regulating Reservoir

Proposed Regulating Reservoir

Proposed Regulating Reservoir

Proposed Regulating Reservoir

Proposed Regulating Reservoir

Proposed Regulating Reservoir

Proposed Regulating Reservoir

Proposed Regulating Reservoir

Proposed Regulating Reservoir

Proposed Regulating Reservoir

Proposed Regulating Reservoir

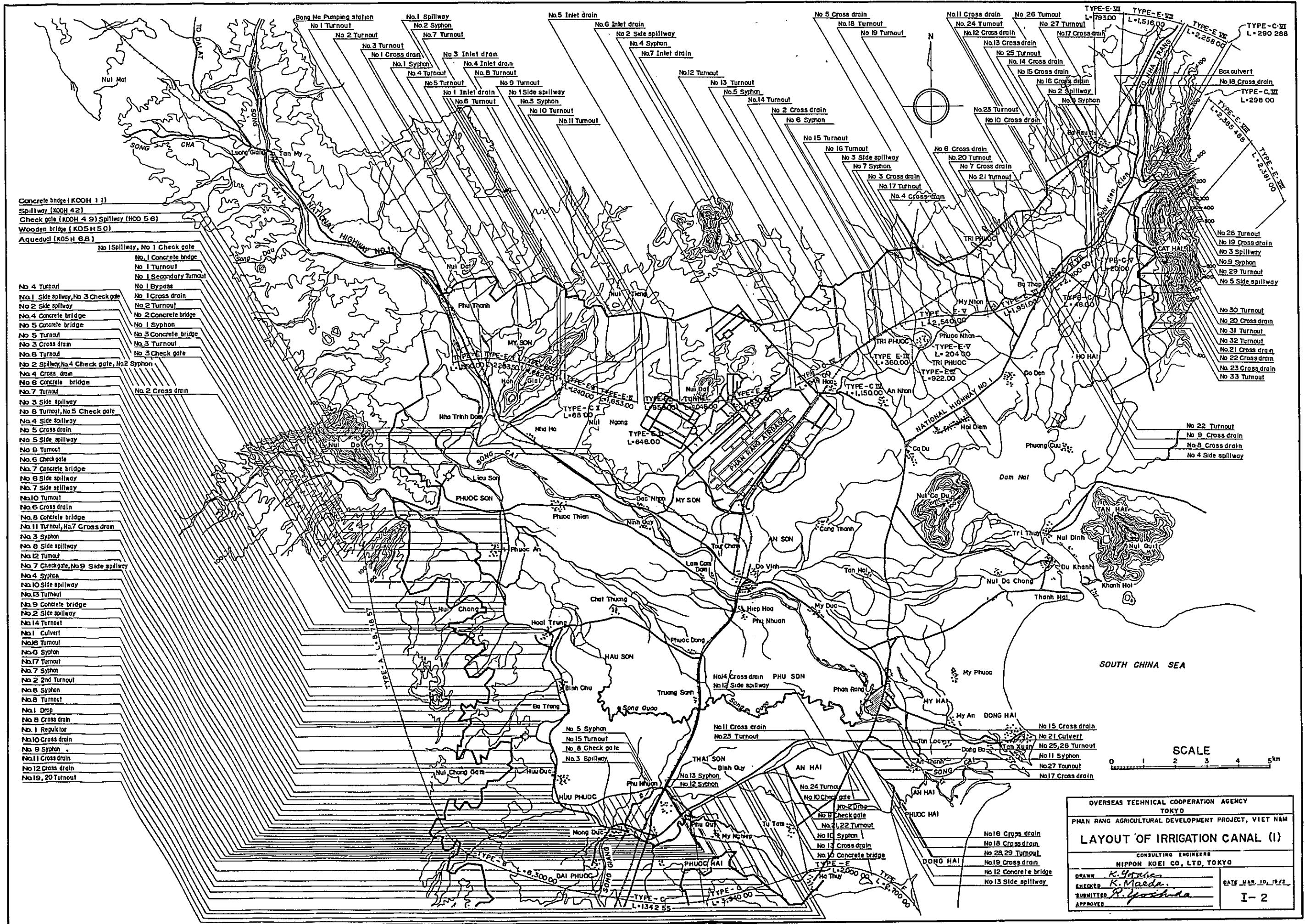

Concrete bridge (K00H 1 I)
 Spillway (K00H 4 2)
 Check gate (K00H 4 9) Spillway (H00 5 6)
 Wooden bridge (K05H 5 0)
 Aqueduct (K05H 6 8)

- No 1 Spillway, No 1 Check gate
- No 1 Concrete bridge
- No 1 Turnout
- No 1 Secondary Turnout
- No 1 Bypass
- No 1 Cross drain
- No 2 Turnout
- No 2 Concrete bridge
- No 1 Syphon
- No 3 Concrete bridge
- No 3 Turnout
- No 3 Check gate
- No 2 Spillway, No 4 Check gate, No 2 Syphon
- No 4 Cross drain
- No 6 Concrete bridge
- No 7 Turnout
- No 2 Cross drain
- No 3 Side spillway
- No 8 Turnout, No 5 Check gate
- No 4 Side spillway
- No 5 Cross drain
- No 5 Side spillway
- No 9 Turnout
- No 6 Check gate
- No 7 Concrete bridge
- No 8 Side spillway
- No 7 Side spillway
- No 10 Turnout
- No 6 Cross drain
- No 8 Concrete bridge
- No 11 Turnout, No 7 Cross drain
- No 3 Syphon
- No 8 Side spillway
- No 12 Turnout
- No 7 Check gate, No 9 Side spillway
- No 4 Syphon
- No 10 Side spillway
- No 13 Turnout
- No 9 Concrete bridge
- No 2 Side spillway
- No 14 Turnout
- No 1 Culvert
- No 6 Turnout
- No 6 Syphon
- No 17 Turnout
- No 7 Syphon
- No 2 2nd Turnout
- No 6 Syphon
- No 8 Turnout
- No 1 Drop
- No 8 Cross drain
- No 1 Regular
- No 10 Cross drain
- No 9 Syphon
- No 11 Cross drain
- No 12 Cross drain
- No 19, 20 Turnout

OVERSEAS TECHNICAL COOPERATION AGENCY
 TOKYO

PHAN RANG AGRICULTURAL DEVELOPMENT PROJECT, VIET NAM

LAYOUT OF IRRIGATION CANAL (I)

CONSULTING ENGINEERS
 NIPPON KOEI CO., LTD. TOKYO

DRAWN *K. Yoda*
 CHECKED *K. Maeda*
 SUBMITTED *R. Yoshida*
 APPROVED

DATE MAR. 10, 1972

I-2

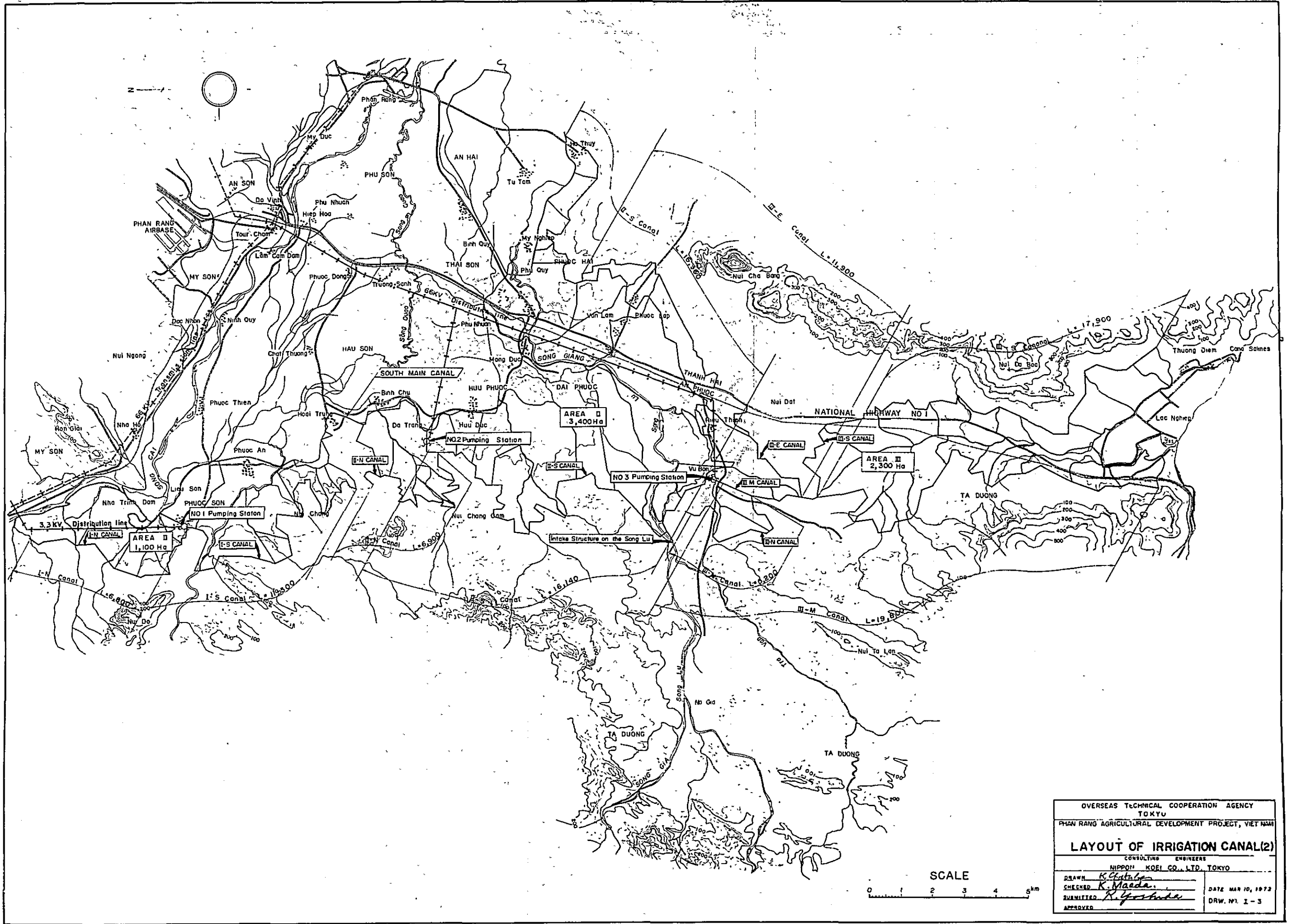



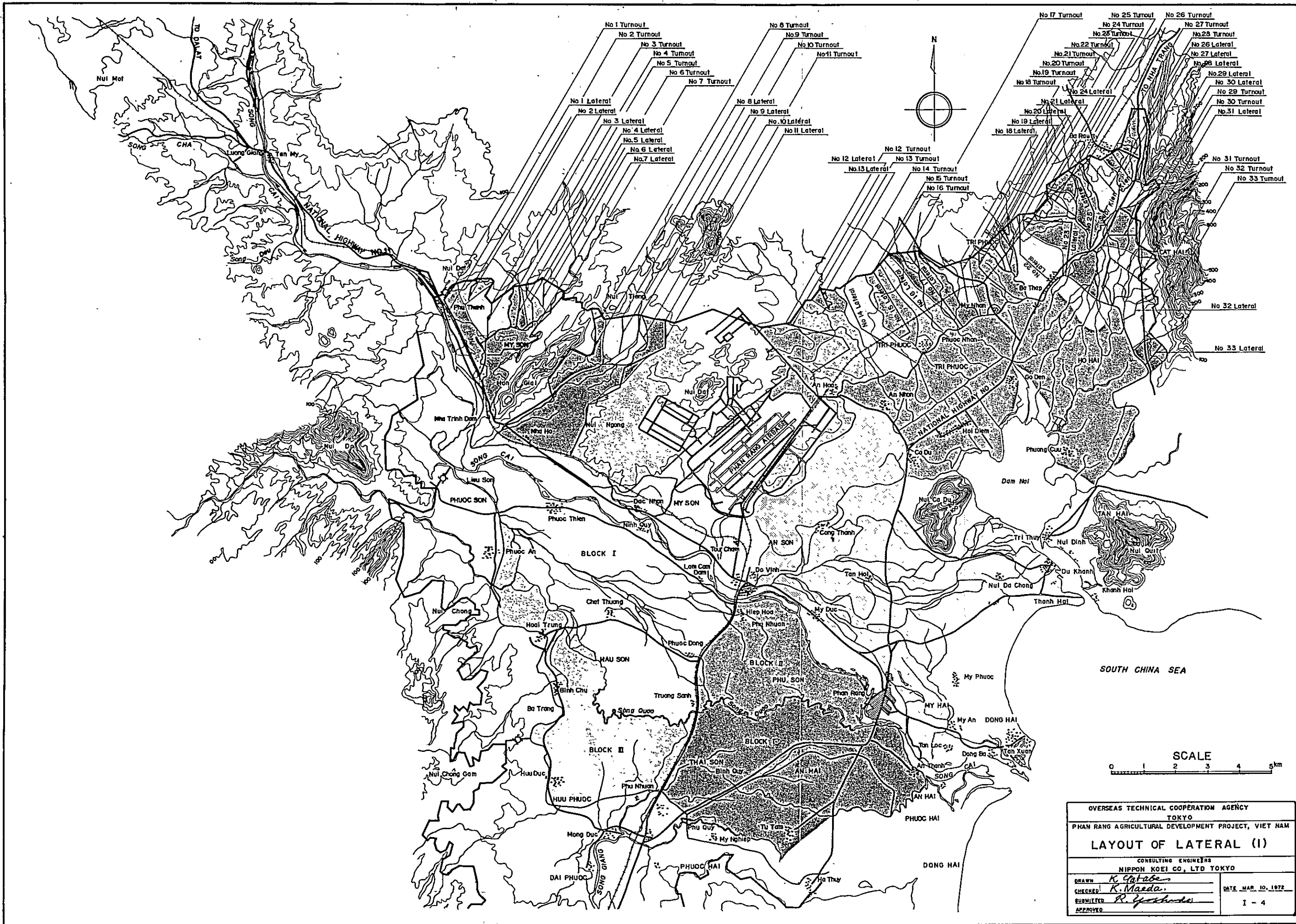

OVERSEAS TECHNICAL COOPERATION AGENCY TOKYO	
PHAN RANG AGRICULTURAL DEVELOPMENT PROJECT, VIET NAM	
LAYOUT OF IRRIGATION CANAL(2)	
CONSULTING ENGINEERS NIPPON KOEI CO., LTD. TOKYO	
DRAWN <i>K. Matsuda</i>	DATE MAR 10, 1972
CHECKED <i>K. Maeda</i>	DRW. NO. I-3
SUBMITTED <i>K. Yoshida</i>	
APPROVED	

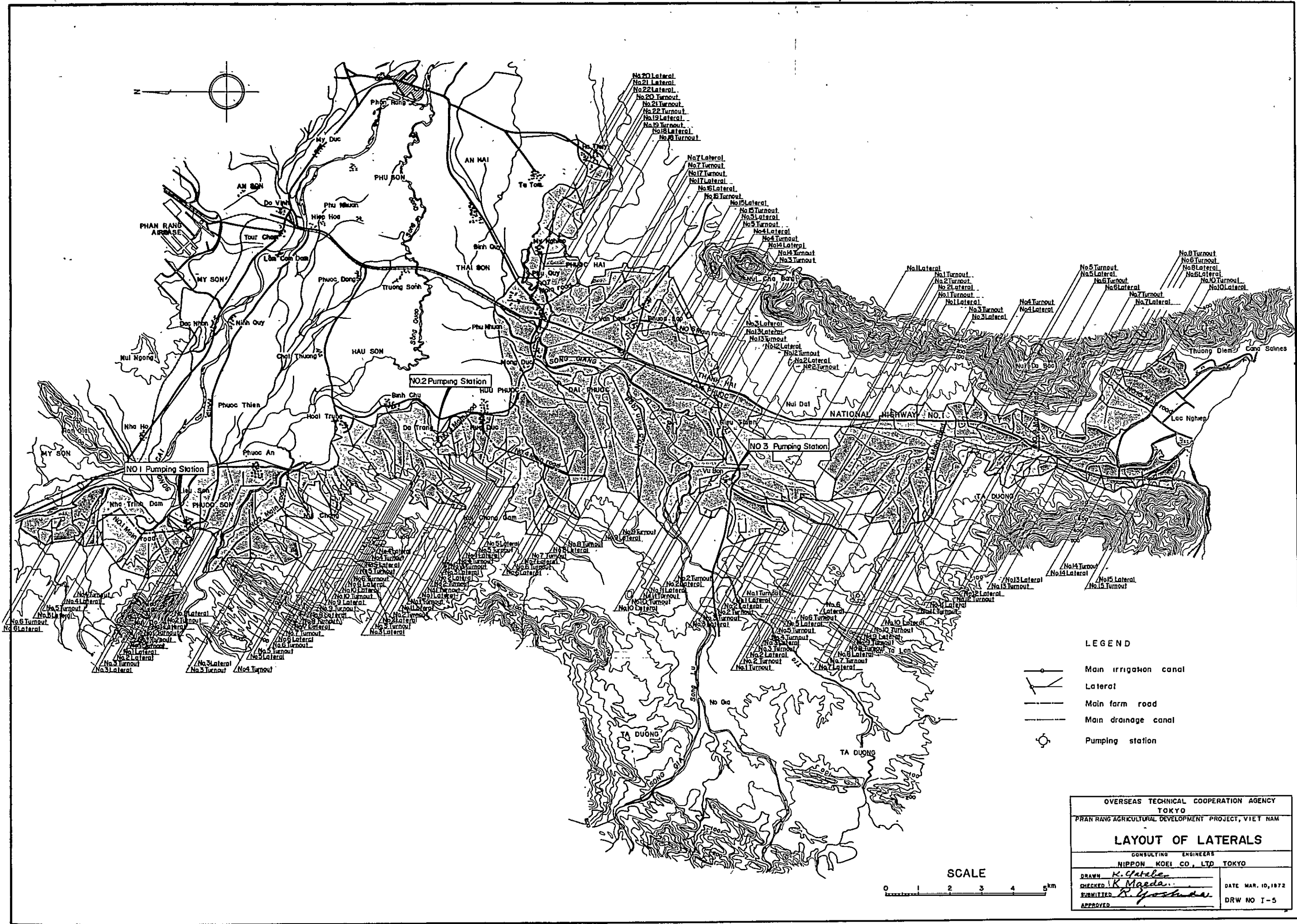

OVERSEAS TECHNICAL COOPERATION AGENCY TOKYO	
PHAN RANG AGRICULTURAL DEVELOPMENT PROJECT, VIET NAM	
LAYOUT OF LATERAL (I)	
CONSULTING ENGINEERS NIPPON KOEI CO., LTD TOKYO	
DRAWN <i>K. Gatabes</i>	DATE MAR 10, 1972
CHECKED <i>K. Maeda</i>	
SUBMITTED <i>R. Yoshida</i>	
APPROVED	I - 4



- LEGEND
-  Main irrigation canal
 -  Lateral
 -  Main farm road
 -  Main drainage canal
 -  Pumping station

OVERSEAS TECHNICAL COOPERATION AGENCY TOKYO	
PHAN RANG AGRICULTURAL DEVELOPMENT PROJECT, VIET NAM	
LAYOUT OF LATERALS	
CONSULTING ENGINEERS NIPPON KOEI CO., LTD TOKYO	
DRAWN <i>K. Uetake</i>	DATE MAR. 10, 1972
CHECKED <i>K. Maeda</i>	DRW NO J-5
SUBMITTED <i>R. Yoshida</i>	
APPROVED	

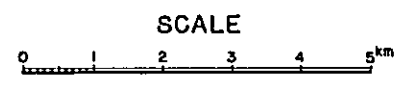

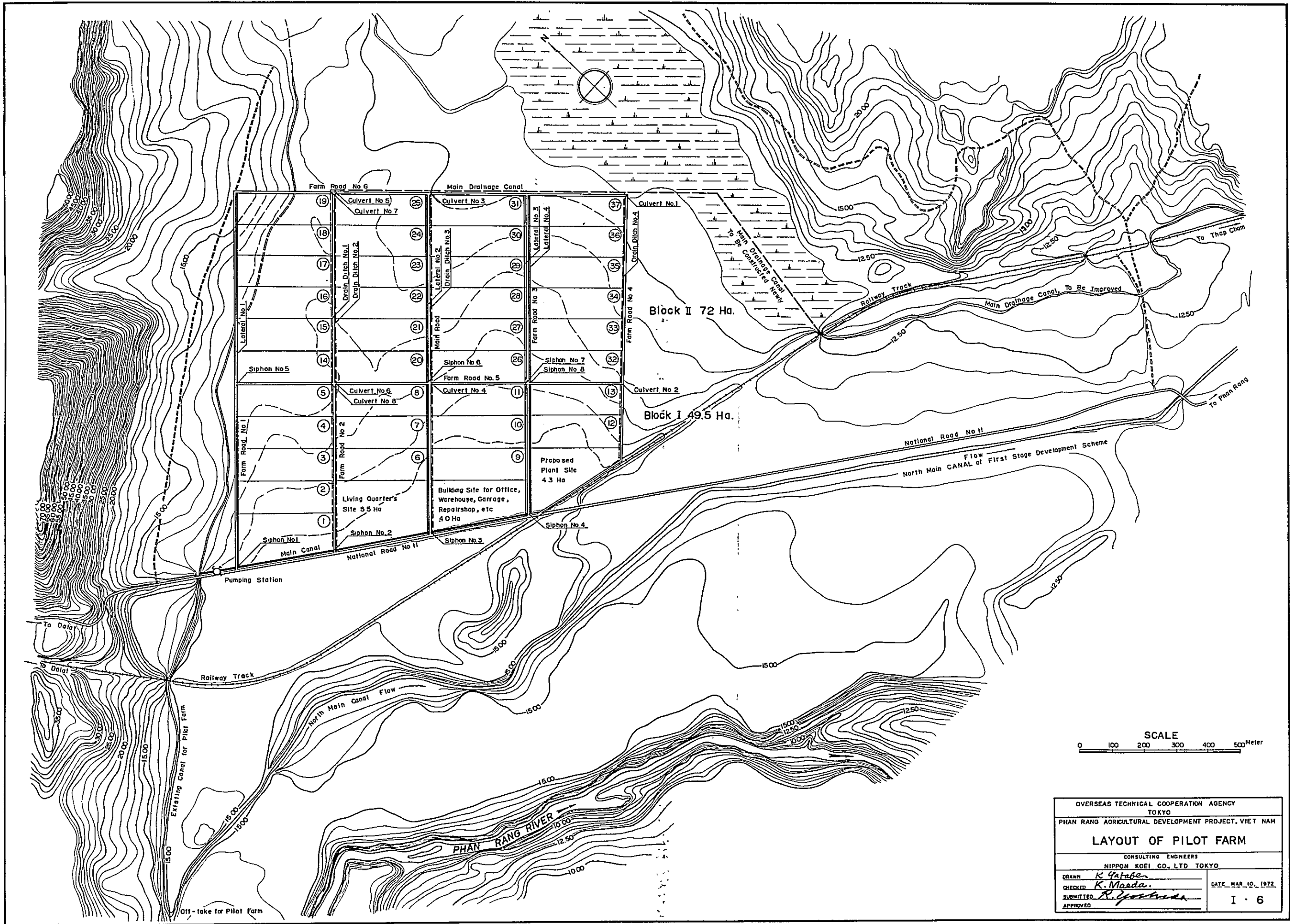

OVERSEAS TECHNICAL COOPERATION AGENCY
 TOKYO
 PHAN RANG AGRICULTURAL DEVELOPMENT PROJECT, VIET NAM

LAYOUT OF PILOT FARM

CONSULTING ENGINEERS
 NIPPON KOEI CO., LTD TOKYO

DRAWN *K. Gatabe*
 CHECKED *K. Maeda*
 SUBMITTED *R. Yoshida*
 APPROVED

DATE: MAR. 10, 1972
 I - 6

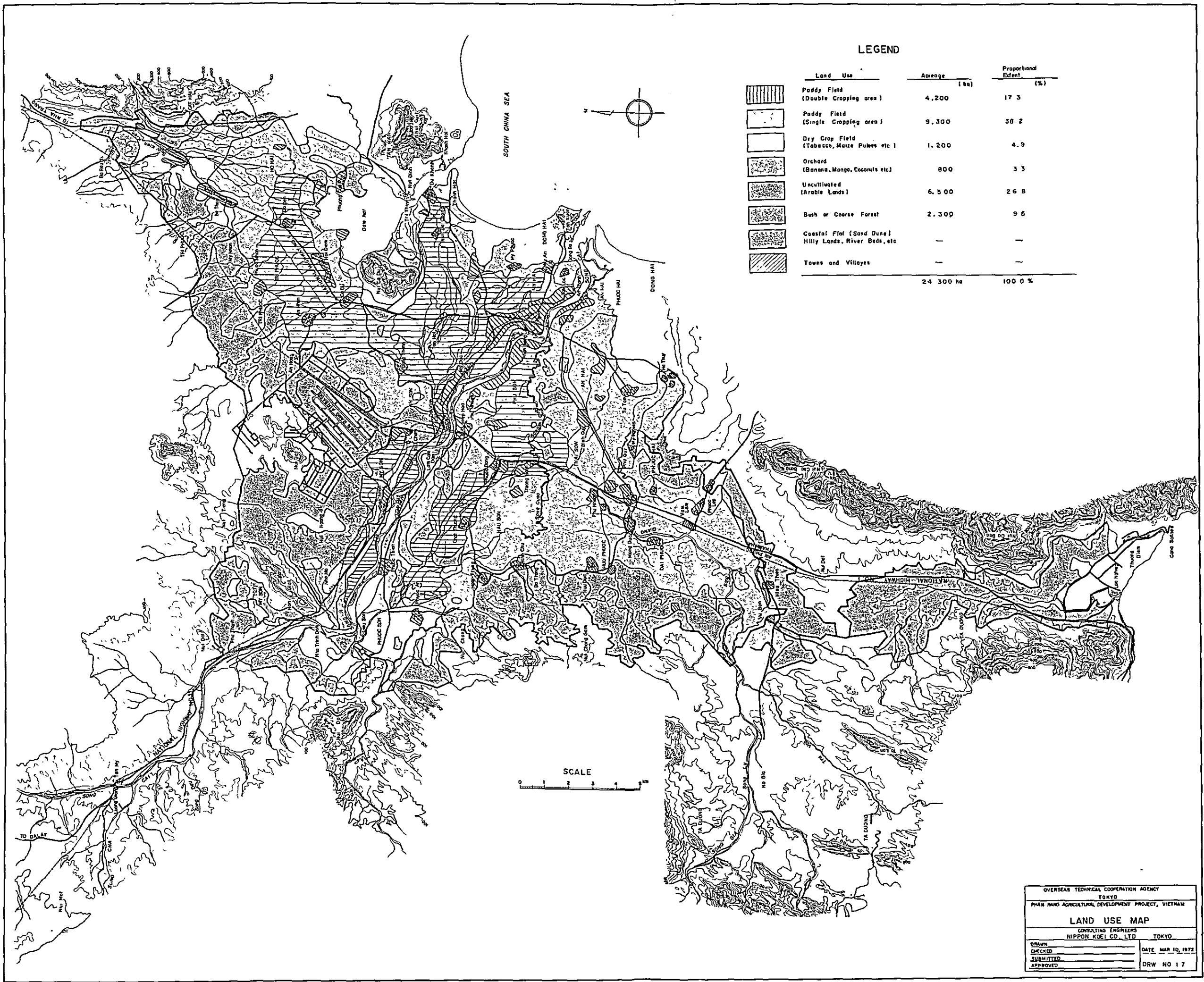

LEGEND

Land Use	Acreage (ha)	Proportional Extent (%)
Paddy Field (Double Cropping area)	4,200	17.3
Paddy Field (Single Cropping area)	9,300	38.2
Dry Crop Field (Tobacco, Maize, Pulses, etc.)	1,200	4.9
Orchard (Banana, Mango, Coconuts, etc.)	800	3.3
Uncultivated (Arable Lands)	6,500	26.8
Bush or Coarse Forest	2,300	9.5
Coastal Flat (Sand Dune), Hilly Lands, River Beds, etc.	—	—
Towns and Villages	—	—
24,300 ha		100.0%



OVERSEAS TECHNICAL COOPERATION AGENCY
 TOKYO
 PHAN HANO AGRICULTURAL DEVELOPMENT PROJECT, VIETNAM

LAND USE MAP

CONSULTING ENGINEERS
 NIPPON KOGI CO., LTD. TOKYO

DRAWN _____
 CHECKED _____ DATE MAR 10, 1972
 SUBMITTED _____
 APPROVED _____ DRW NO 17

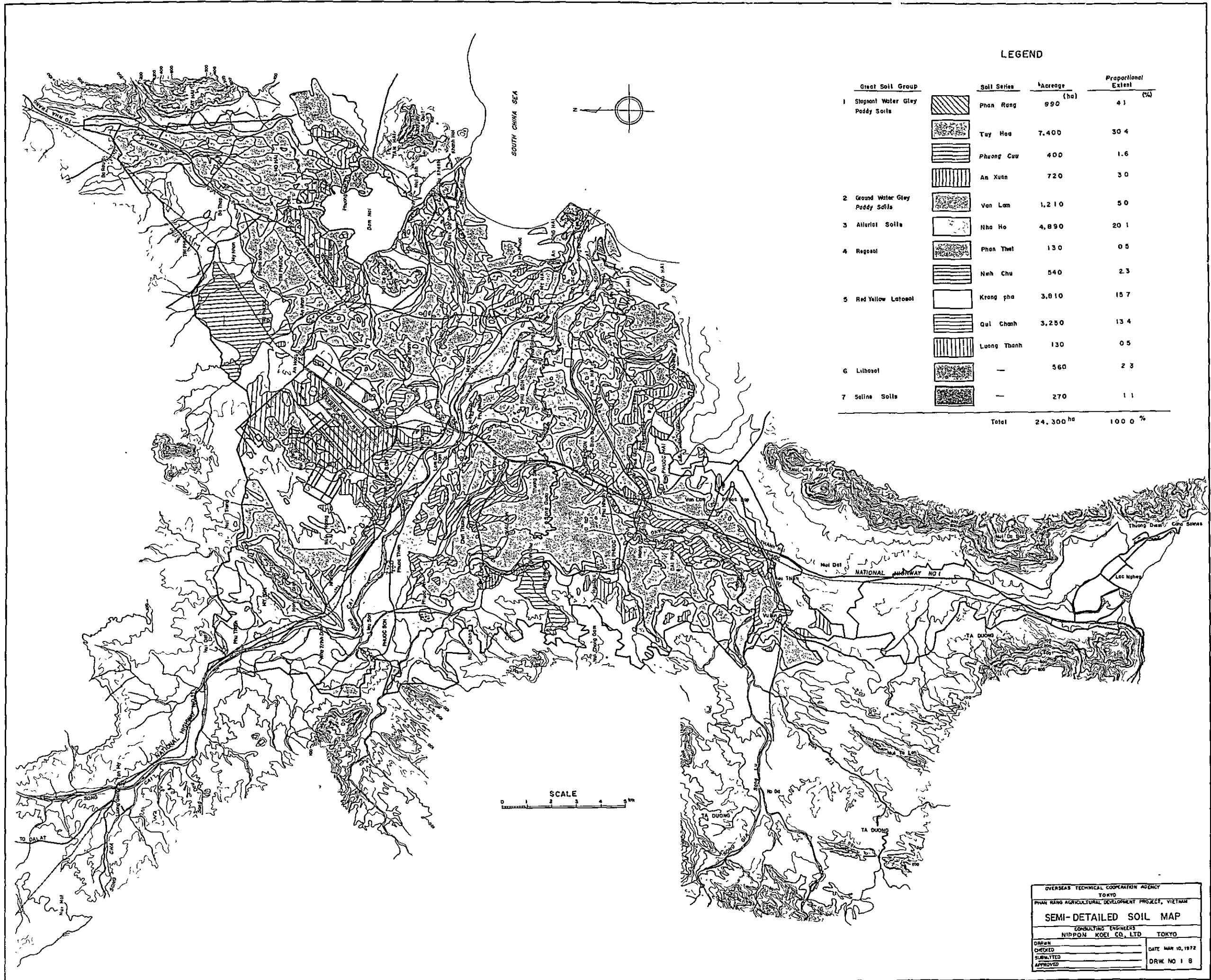

LEGEND

Great Soil Group	Soil Series	Acreage (ha)	Proportional Extent (%)
1 Stagnant Water Gley Paddy Soils	Phan Rang	990	4.1
	Tuy Hoa	7,400	30.4
	Phuong Cuu	400	1.6
	An Xuan	720	3.0
2 Ground Water Gley Paddy Soils	Van Lam	1,210	5.0
	Nha Ho	4,890	20.1
3 Alluvial Soils	Phan Thiet	130	0.5
4 Regosol	Ninh Chu	540	2.3
	Krang pha	3,810	15.7
5 Red Yellow Latosol	Qui Chanh	3,250	13.4
	Luong Thanh	130	0.5
	—	560	2.3
6 Lithosol	—	270	1.1
7 Saline Soils	—	—	—
Total		24,300 ha	100.0 %

SCALE
0 1 2 3 4 5 km

OVERSEAS TECHNICAL COOPERATION AGENCY
 TOKYO
 PHAN RANG AGRICULTURAL DEVELOPMENT PROJECT, VIETNAM

SEMI-DETAILED SOIL MAP

CONSULTING ENGINEERS
 NIPPON KOEI CO., LTD. TOKYO

DRAWN	DATE MAR 10, 1972
CHECKED	
SUBMITTED	
APPROVED	DRW. NO 18

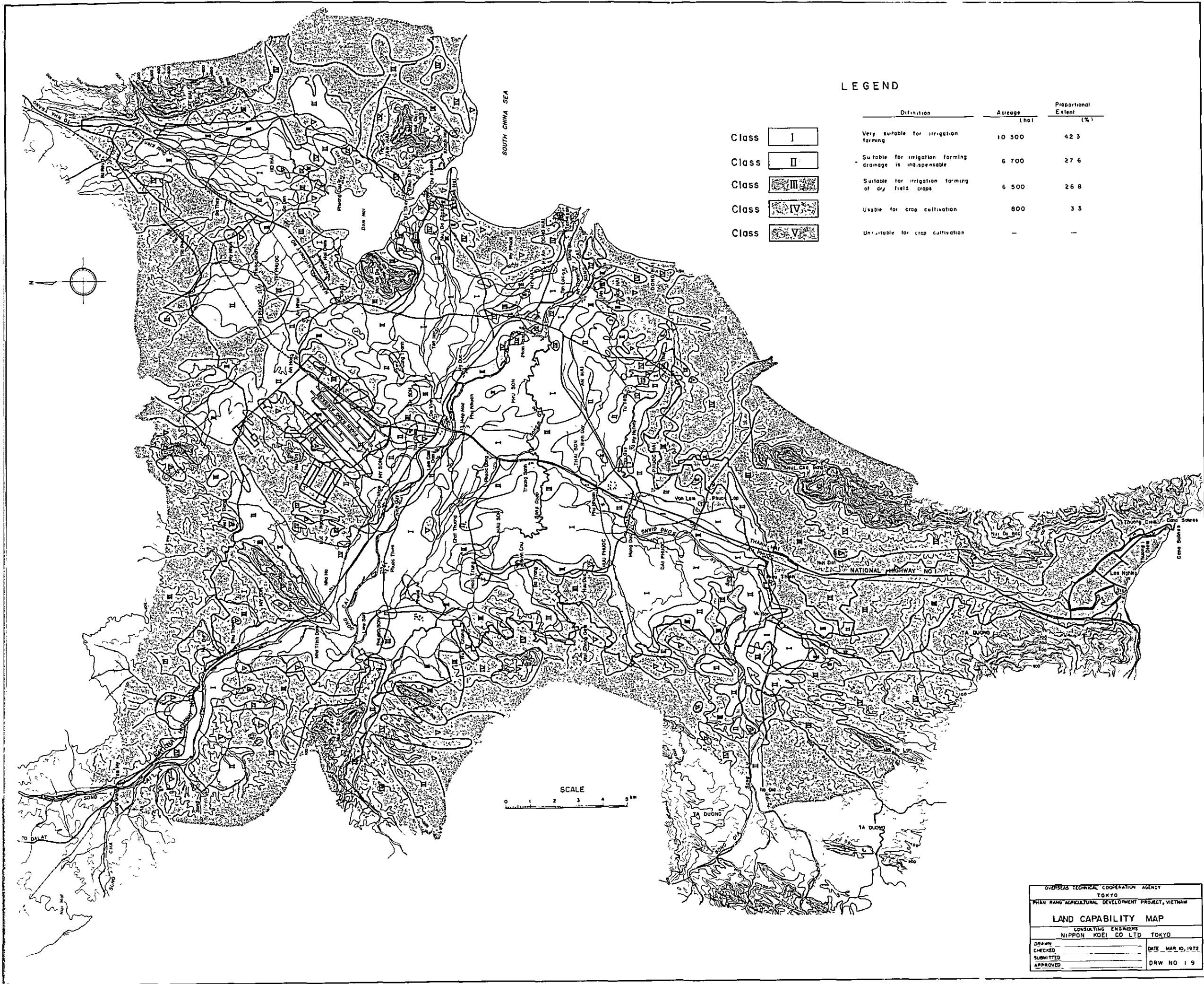

LEGEND

Class	Definition	Acreage (ha)	Proportional Extent (%)
Class I	Very suitable for irrigation farming	10 300	42.3
Class II	Suitable for irrigation farming drainage is indispensable	6 700	27.6
Class III	Suitable for irrigation farming of dry field crops	6 500	26.8
Class IV	Usable for crop cultivation	800	3.3
Class V	Unsuitable for crop cultivation	-	-

SCALE



OVERSEAS TECHNICAL COOPERATION AGENCY
 TOKYO
 PHAN HANG AGRICULTURAL DEVELOPMENT PROJECT, VIETNAM

LAND CAPABILITY MAP

CONSULTING ENGINEERS
 NIPPON KOEI CO. LTD. TOKYO

DRAWN	DATE MAR. 10, 1972
CHECKED	
SUBMITTED	
APPROVED	DRW NO 19

PROPOSED LAYOUT OF THE SUGAR PLANT

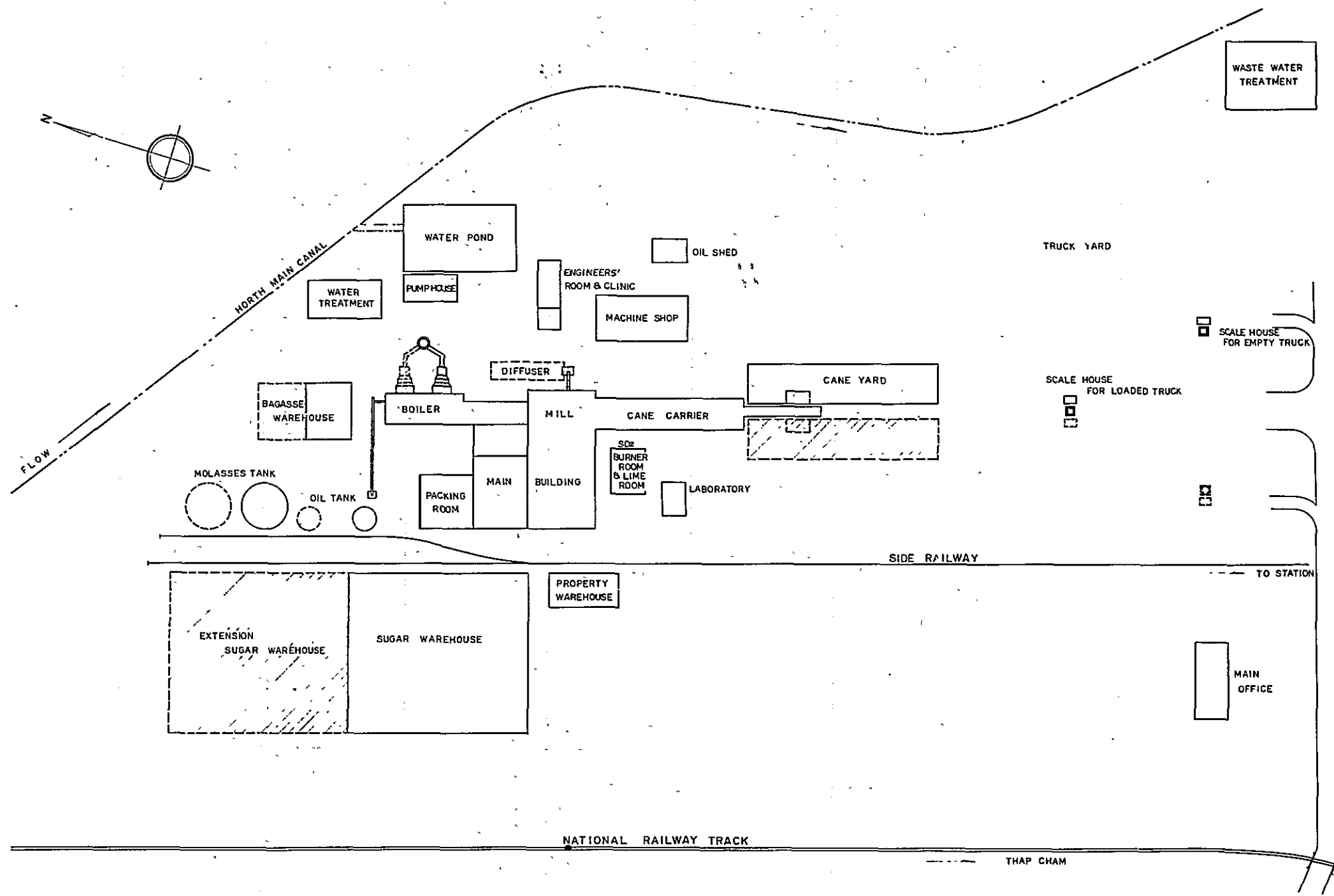

REMARK:
 [Hatched Box] : TO BE EXTENDED
 IN THE SECOND PHASE
 (4,000 TON / DAY)

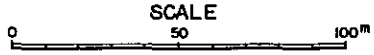

OVERSEAS TECHNICAL COOPERATION AGENCY	
TOKYO	
PHAN RANG AGRICULTURAL DEVELOPMENT PROJECT, VIET NAM	
PROPOSED LAYOUT OF THE SUGAR PLANT	
CONSULTING ENGINEERS NIPPON KOEI CO., LTD. TOKYO	
DRAWN <i>K. Otake</i>	DATE MAR 10, 1972
CHECKED <i>K. Maeda</i>	I - 10
SUBMITTED <i>R. Yoshida</i>	
APPROVED	

Flow Diagram of Plantation White Sugar Plant Sulphitation Method

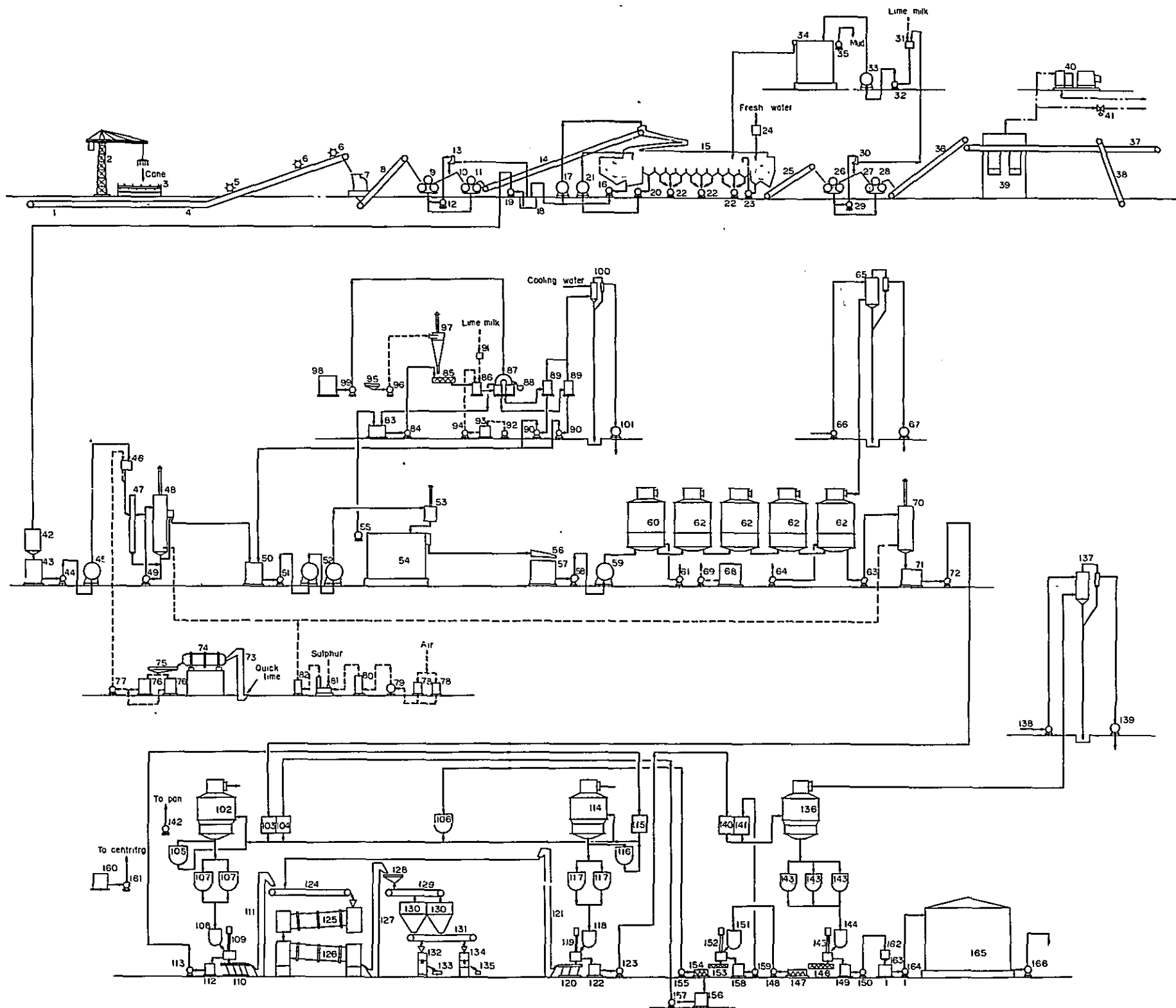

No	Name of machinery	No	Name of machinery
1	Truck scale	93	Coagulant dissolving tank
2	Tower crane	94	Coagulant transfer pump
3	Cane feed table	95	Bagaculo screen
4	Cane carrier	96	Bagaculo blower
5	Cane leveller	97	Cyclon separator
6	Cane cutter	98	Hot water tank
7	Cane shredder	99	Hot water pump
8	Shredded cane elevator	100	Condenser
9	1st mill	101	Vacuum pump
10	Intermediate carrier	102	A vacuum pan
11	2nd mill	103	Syrup tank
12	Juice pump	104	Remelt tank
13	Juice strainer	105	Seed mixer
14	Preparation cane conveyer	106	Magma tank
15	Cane diffuser	107	Waiting mixer
16	Scalding juice pump	108	Distributing mixer
17	Scalding juice heater	109	A centrifuge
18	Raw juice tank	110	A sugar conveyer
19	Raw juice pump	111	A sugar elevator
20	Recirculating juice pump	112	A run off tank
21	Recirculating juice heater	113	A run off pump
22	Triple juice pump	114	A vacuum pan
23	Juice pump	115	A molasses tank
24	Fresh water tank	116	Seed mixer
25	Diffused bagasse conveyer	117	Waiting mixer
26	1st dewatering mill	118	Distributing mixer
27	Intermediate carrier	119	B centrifuge
28	2nd dewatering mill	120	B sugar conveyer
29	Press water pump	121	B sugar elevator
30	Press water strainer	122	B run off tank
31	Lime mixing tank	123	B run off pump
32	Limed press water pump	124	Wet sugar conveyer
33	Limed press water heater	125	Sugar dryer
34	Press water clarifier	126	Sugar cooler
35	Mud pump	127	Dry sugar elevator
36	Bagasse elevator	128	Sugar screen
37	Bagasse conveyer	129	Sugar conveyer
38	Return elevator	130	Sugar bin
39	Boiler	131	Sugar conveyer
40	Turbo-generator	132	20 kg bag packer
41	Reducing valve and desuperheater	133	Bagged sugar conveyer
42	Juice scale	134	1-2 kg bag packer
43	Weighed juice receiver	135	Bagged sugar conveyer
44	Weighed juice pump	136	C vacuum pan
45	1st juice heater	137	Condenser
46	Lime milk dosing apparatus	138	Injection water pump
47	Pretiming vessel	139	Vacuum pump
48	Juice sulphitation tank	140	B molasses tank
49	Circulation pump	141	C wash molasses tank
50	Sulphured juice receiver	142	Pan washing pump
51	Sulphured juice pump	143	Crystallizer
52	2nd juice heater	144	Distributing mixer
53	Flash tank	145	C centrifuge (fore worker)
54	Clarifier	146	C sugar conveyer
55	Mud pump	147	Magma mixer
56	Juice screen	148	Magma pump
57	Clear juice tank	149	C run off tank
58	Clear juice pump	150	C run off pump
59	Pre-heater	151	Distributing mixer
60	Pre-evaporator	152	C centrifuge (after worker)
61	Drain pump	153	C wash sugar conveyer
62	Quadruple effect evaporator	154	Magma mixer
63	Syrup pump	155	Magma pump
64	Drain pump	156	Remelter
65	Condenser	157	Remelt pump
66	Injection water pump	158	C wash run off tank
67	Vacuum pump	159	C wash run off pump
68	Soda pump	160	Hot water tank
69	Soda pump	161	Hot water pump
70	Syrup sulphitation tank	162	Exhaust molasses scale
71	Sulphured syrup tank	163	Weighed molasses receiver
72	Sulphured syrup pump	164	Weighed molasses pump
73	Quick lime elevator	165	Exhaust molasses storage tank
74	Lime slaker	166	Exhaust molasses pump
75	Classifier		
76	Lime milk tank		
77	Lime milk pump		
78	Air dryer		
79	Air compressor		
80	Air chamber		
81	Sulphur oven		
82	SO ₂ gas scrubber		
83	Overflow receiver		
84	Return pump		
85	Bagaculo mixing tank		
86	Coagulator		
87	Mud filter		
88	Cake conveyer		
89	Vacuum receiver		
90	Filtrate pump		
91	Lime milk splitter box		
92	Coagulant feed pump		

OVERSEAS TECHNICAL COOPERATION AGENCY
TOKYO

PHAN RANG AGRICULTURAL DEVELOPMENT PROJECT, VIET NAM

FLOW DIAGRAM OF PLANTATION WHITE SUGAR PLANT

CONSULTING ENGINEERS
NIPPON KOEI CO., LTD TOKYO

DRAWN <i>K. Maeda</i>	DATE MAR 10, 1972
CHECKED <i>K. Maeda</i>	
SUBMITTED <i>R. Yoshida</i>	
APPROVED	I - 11

第三期計画編

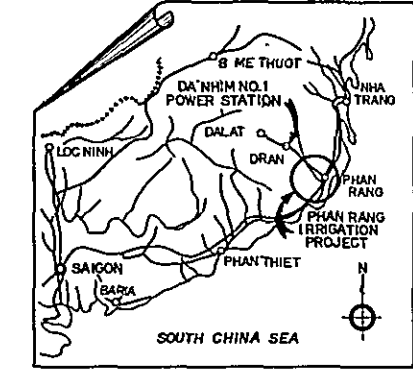
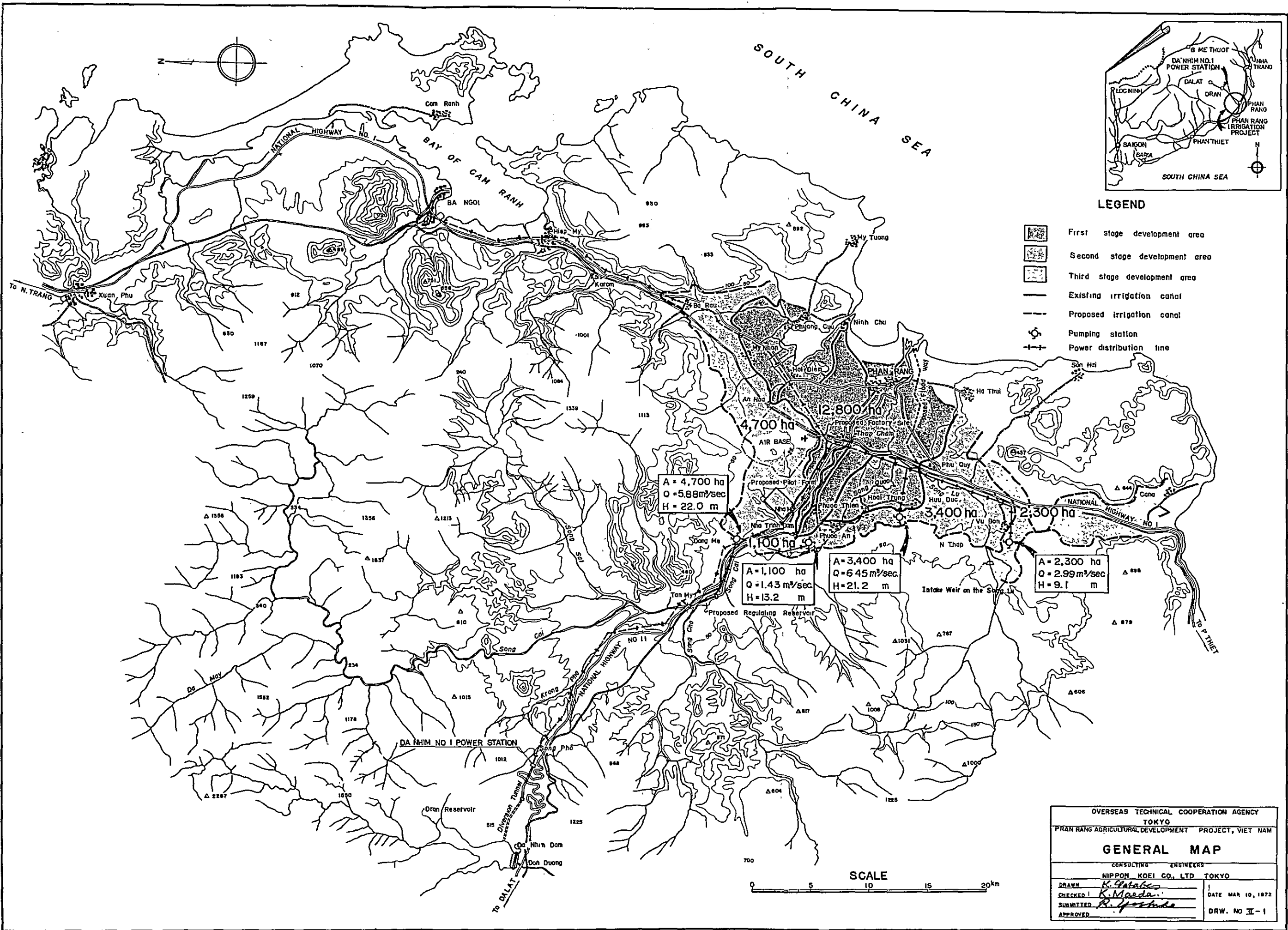

LEGEND

- First stage development area
- Second stage development area
- Third stage development area
- Existing irrigation canal
- Proposed irrigation canal
- Pumping station
- Power distribution line

A = 4,700 ha
Q = 5.88 m³/sec
H = 22.0 m

A = 1,100 ha
Q = 1.43 m³/sec
H = 13.2 m

A = 3,400 ha
Q = 6.45 m³/sec
H = 21.2 m

A = 2,300 ha
Q = 2.99 m³/sec
H = 9.1 m

SCALE
0 5 10 15 20 km

OVERSEAS TECHNICAL COOPERATION AGENCY	
TOKYO	
PHAN RANG AGRICULTURAL DEVELOPMENT PROJECT, VIET NAM	
GENERAL MAP	
CONSULTING ENGINEERS	
NIPPON KOEI CO., LTD TOKYO	
DRAWN <i>K. Goto</i>	DATE MAR 10, 1972
CHECKED <i>K. Maeda</i>	DRW. NO II-1
SUBMITTED <i>R. Yoshida</i>	
APPROVED	

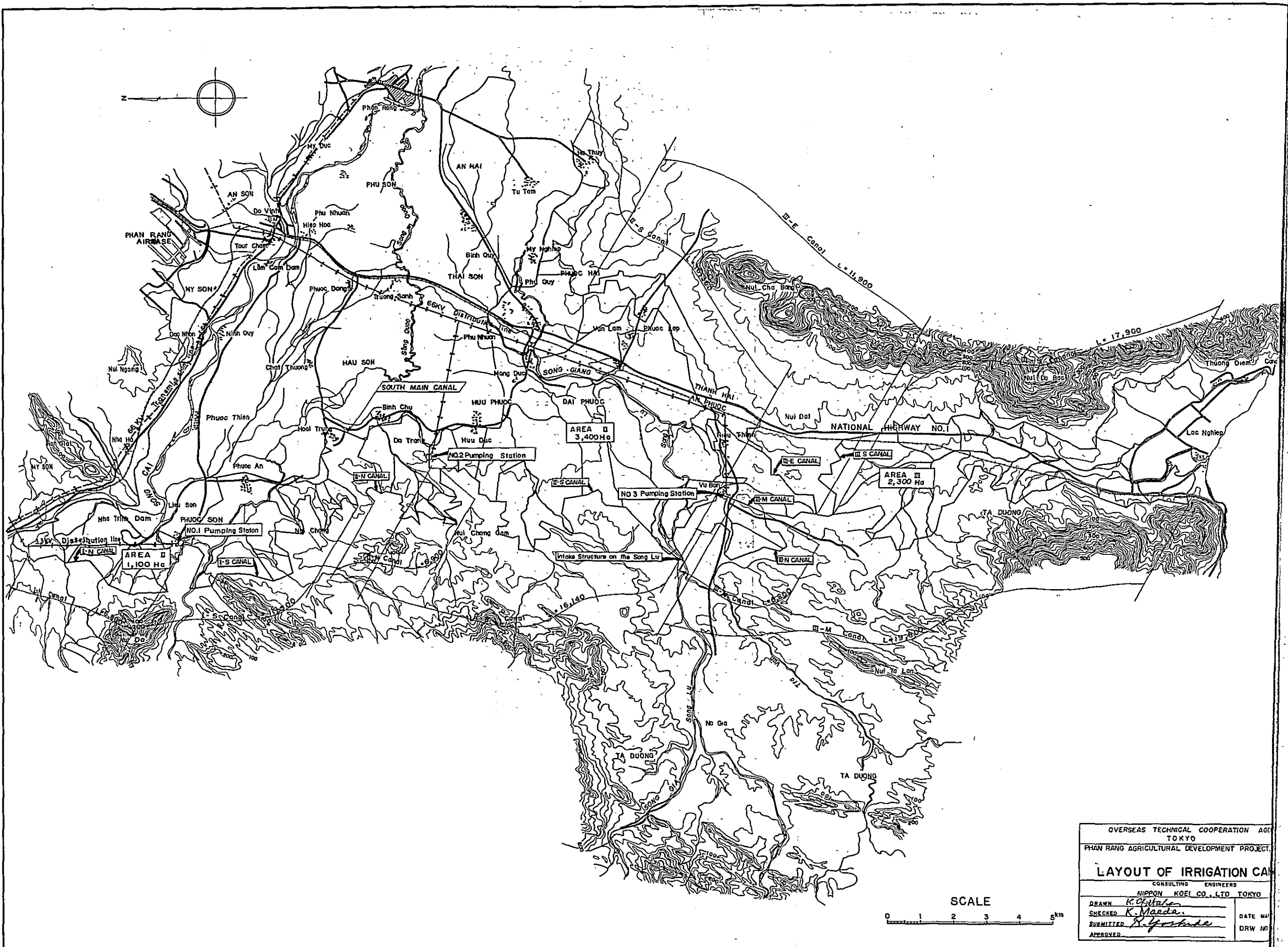

OVERSEAS TECHNICAL COOPERATION AGENCY
 TOKYO
 PHAN RANG AGRICULTURAL DEVELOPMENT PROJECT

LAYOUT OF IRRIGATION CANALS

CONSULTING ENGINEERS
 NIPPON KOGI CO., LTD. TOKYO

DRAWN <i>K. G. G. G.</i>	DATE MADE
CHECKED <i>K. Mada</i>	DRW NO.
SUBMITTED <i>R. Yoshida</i>	
APPROVED	

SCALE
 0 1 2 3 4 5 km

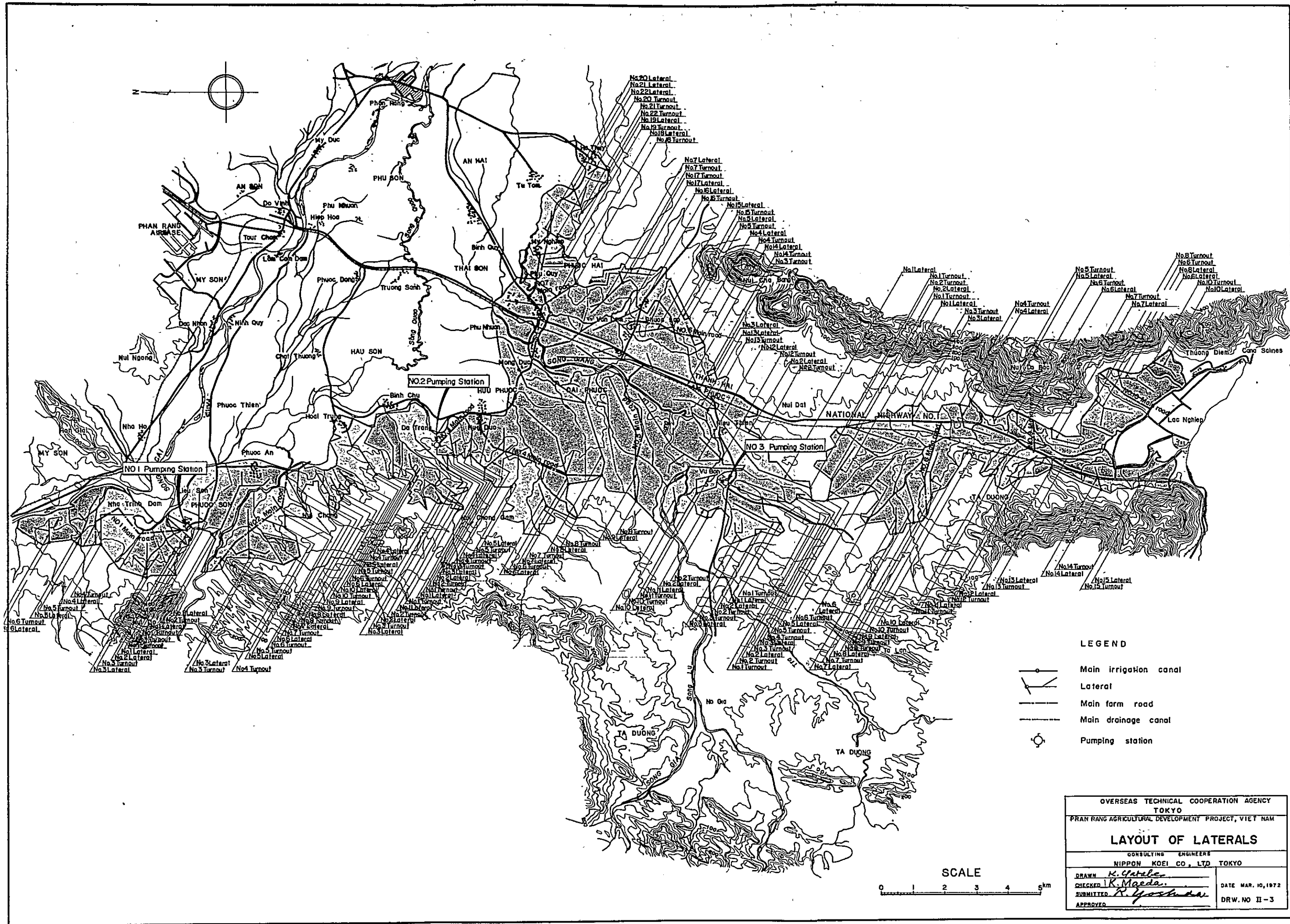

- LEGEND**
- Main irrigation canal
 - Lateral
 - Main farm road
 - Main drainage canal
 - Pumping station

OVERSEAS TECHNICAL COOPERATION AGENCY TOKYO	
PHAN RANG AGRICULTURAL DEVELOPMENT PROJECT, VIET NAM	
LAYOUT OF LATERALS	
CONSULTING ENGINEERS NIPPON KOEI CO., LTD. TOKYO	
DRAWN <i>K. Maeda</i>	DATE MAR. 10, 1972 DRW. NO II-3
CHECKED <i>K. Maeda</i>	
SUBMITTED <i>R. Yoshida</i>	
APPROVED _____	

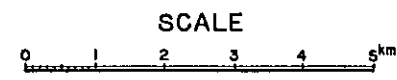

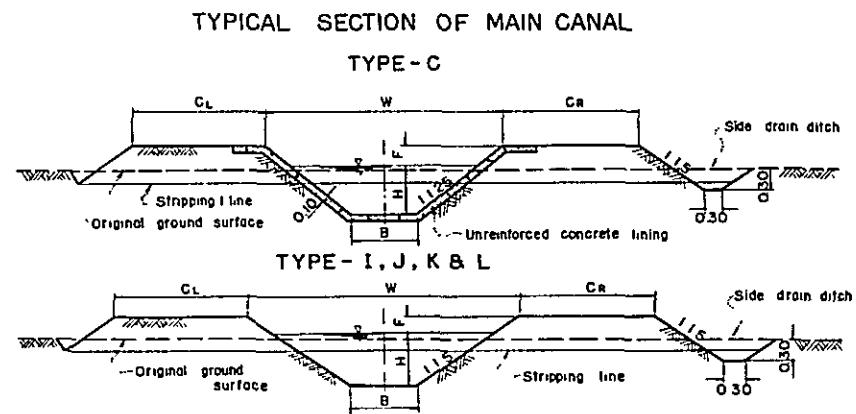
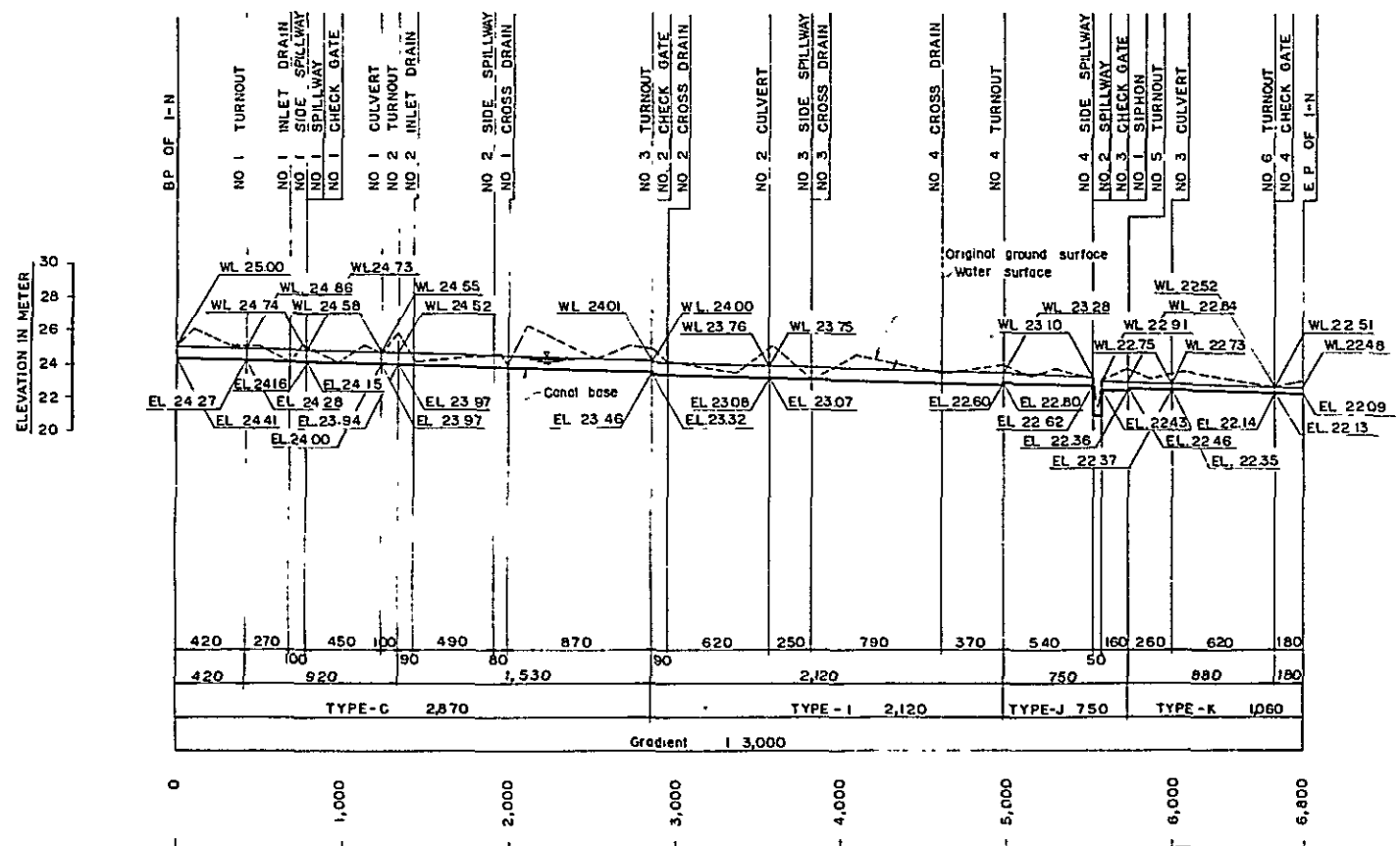
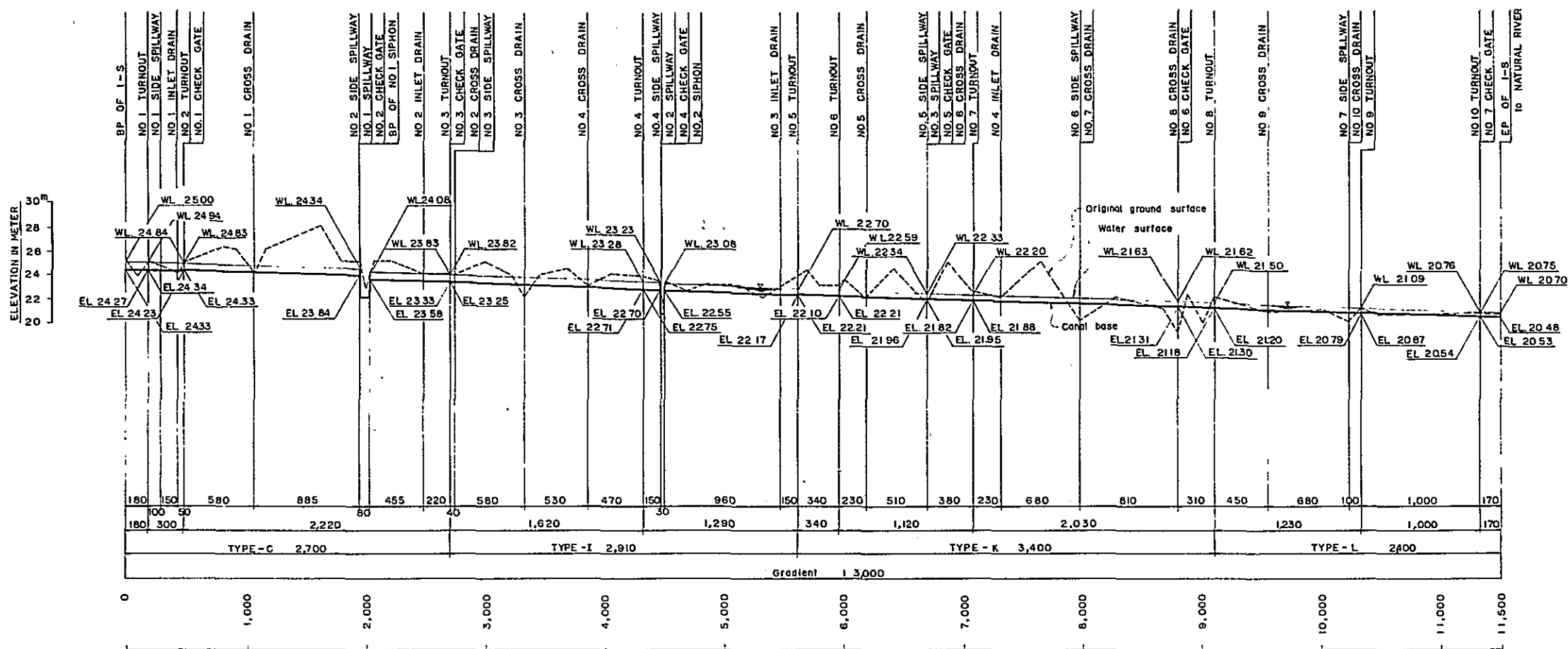

NOTE: Side drain ditch will be constructed on the side where the crest width is 200 m

CANAL	TYPE	DISCHARGE (m ³ /s)	VELOCITY (m/s)	DIMENSION (m)					
				B	H	F	W	Cr	Cl
I-S	C	0.66	0.60	1.00	0.61	0.39	3.00	2.00	3.00
	I	0.31	0.30	1.00	0.57	0.43	4.00	•	•
	K	0.19	0.27	0.75	0.49	0.21	2.85	•	•
	L	0.06	0.19	0.50	0.30	0.20	2.00	•	•
I-N	C	0.63	0.62	1.00	0.62	0.38	3.00	3.00	2.00
	I	0.44	0.33	1.00	0.66	0.32	4.00	•	•
	J	0.23	0.27	1.00	0.48	0.22	3.10	•	•
	K	0.11	0.23	0.75	0.38	0.32	2.85	•	•

OVERSEAS TECHNICAL COOPERATION AGENCY
 TOKYO
 PHAN RANG AGRICULTURAL DEVELOPMENT PROJECT, VIET NAM
**PROFILE AND TYPICAL CROSS SECTION
 OF MAIN IRRIGATION CANAL, I-N.I-S**
 CONSULTING ENGINEERS
 NIPPON KOEI CO., LTD TOKYO

DRAWN: D. G. K. I.
 CHECKED: K. Maeda.
 SUBMITTED: R. Yoshida.
 APPROVED: _____

DATE: MAR. 19, 1972
 II-4

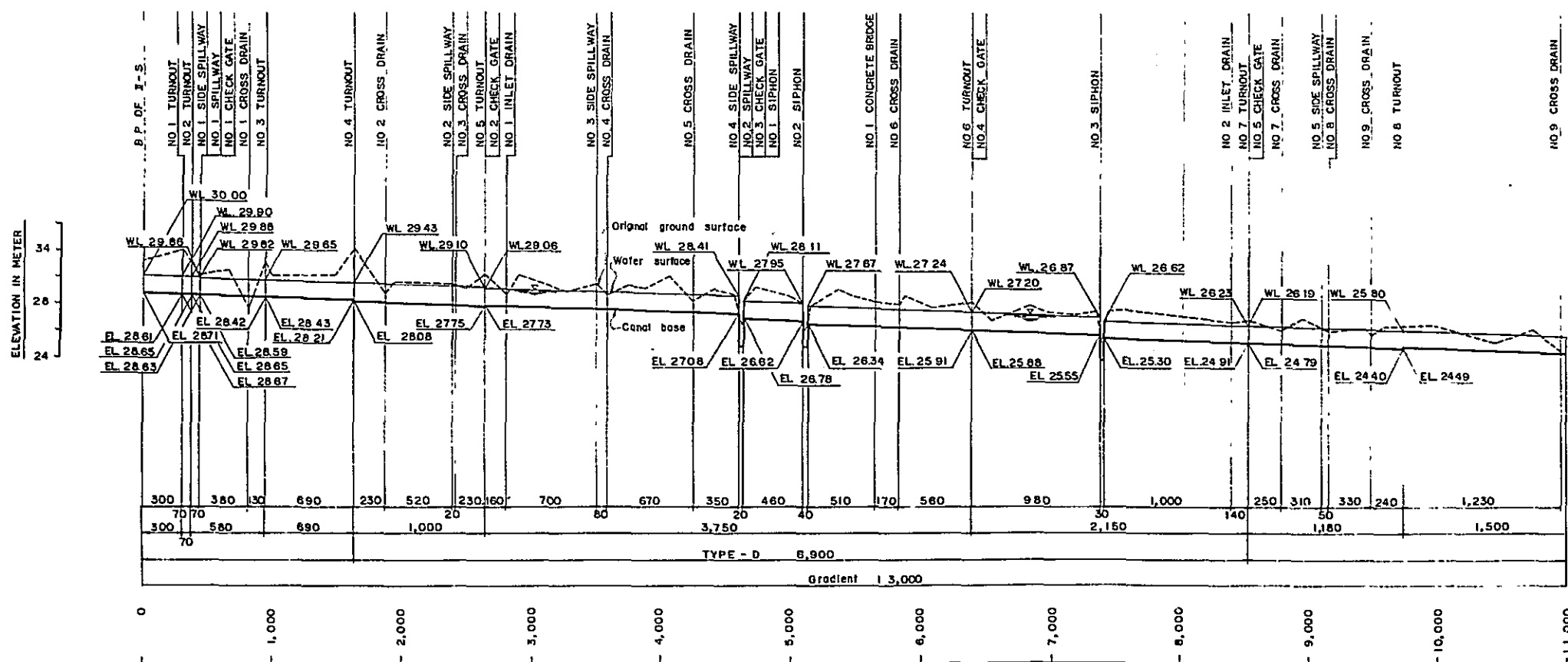
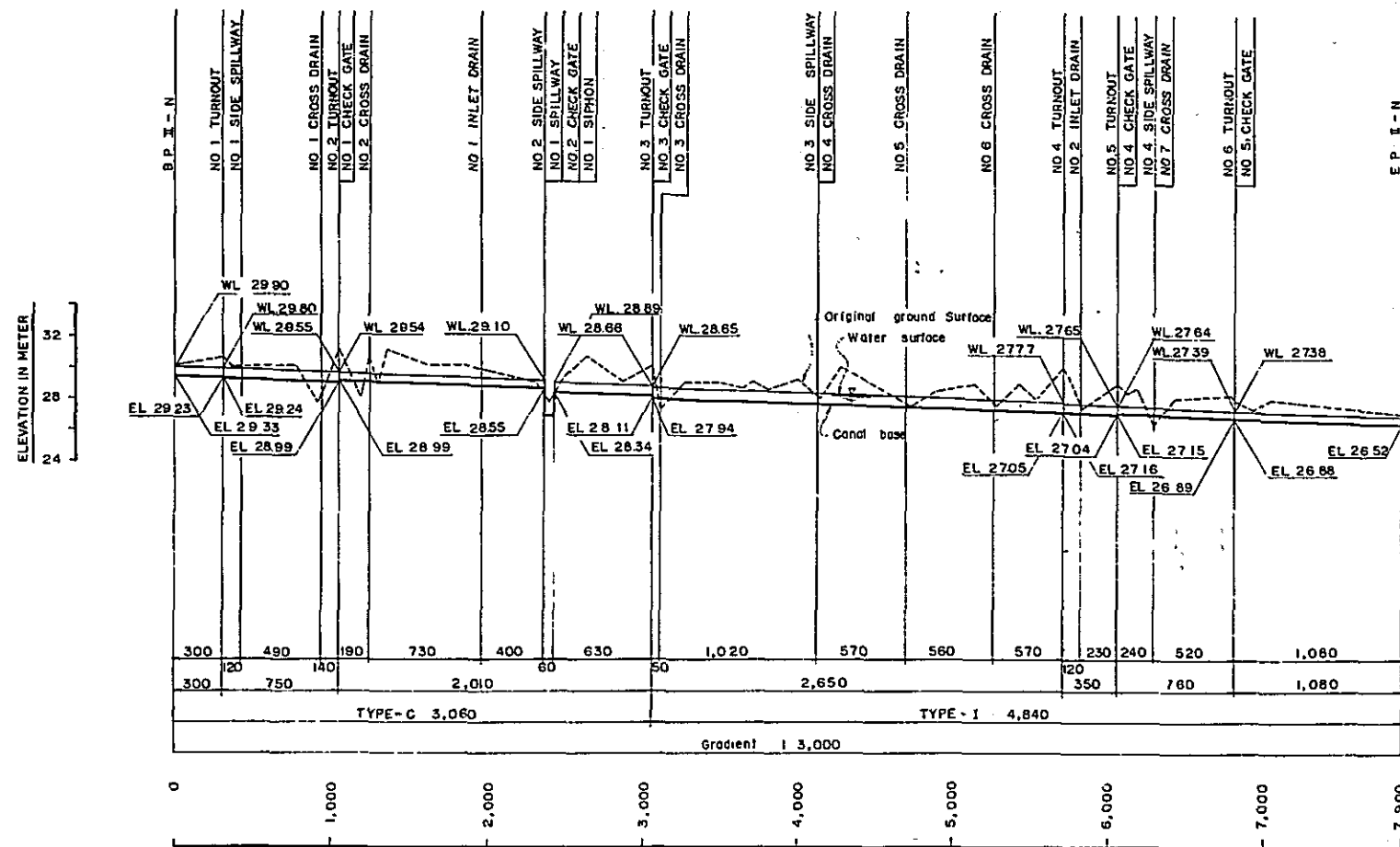

OVERSEAS TECHNICAL COOPERATION AGENCY
TOKYO

PHAN RANG AGRICULTURAL DEVELOPMENT PROJECT, VIET NAM

PROFILE AND TYPICAL CROSS SECTION OF MAIN IRRIGATION CANAL, I-N, I-8

CONSULTING ENGINEERS
NIPPON KOKI CO., LTD TOKYO

DRAWN: *D. G. K.*
CHECKED: *R. Maeda*
SUBMITTED: *R. Maeda*
APPROVED: _____

DATE: MAR 10, 1972

I-5

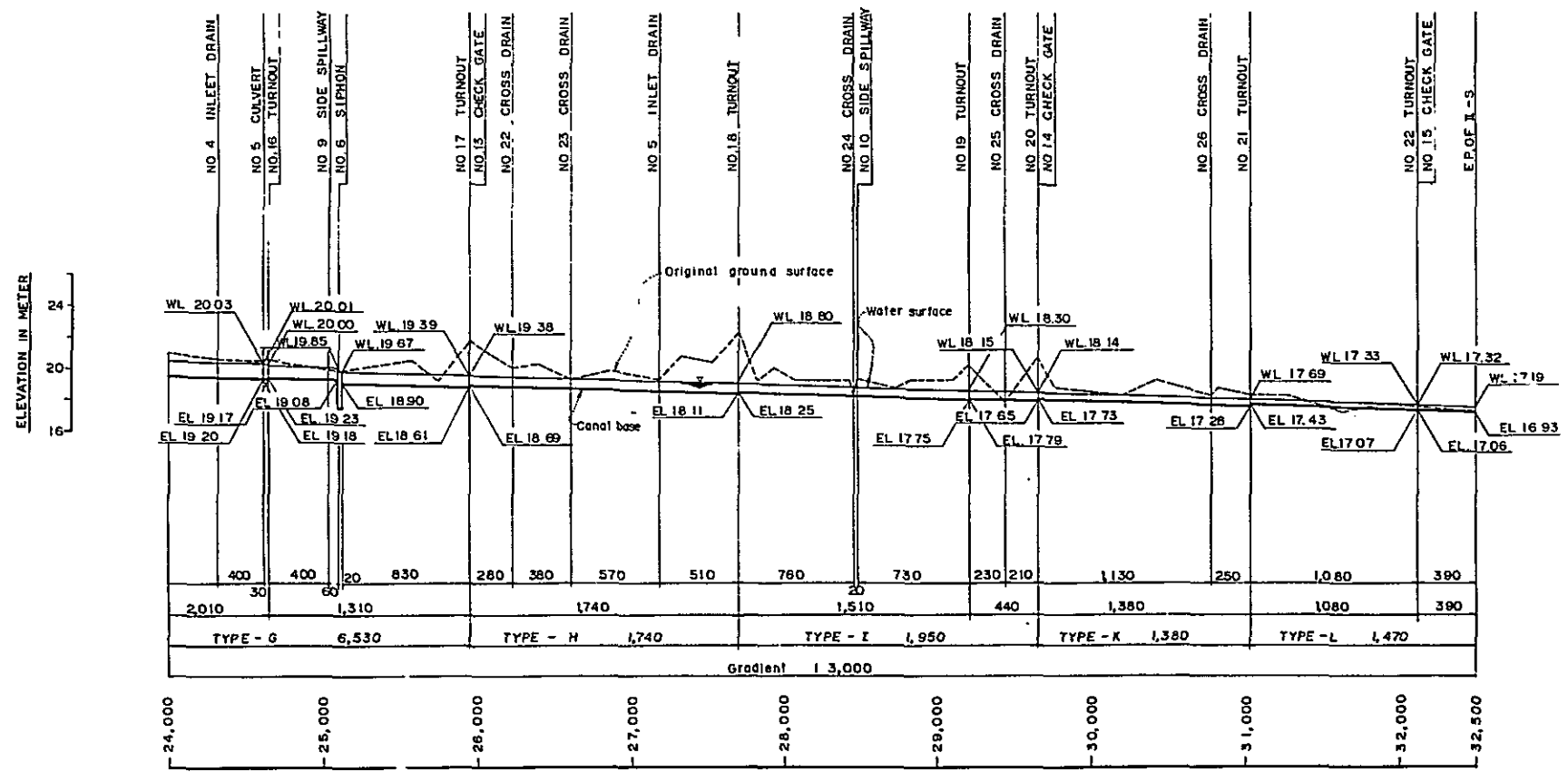
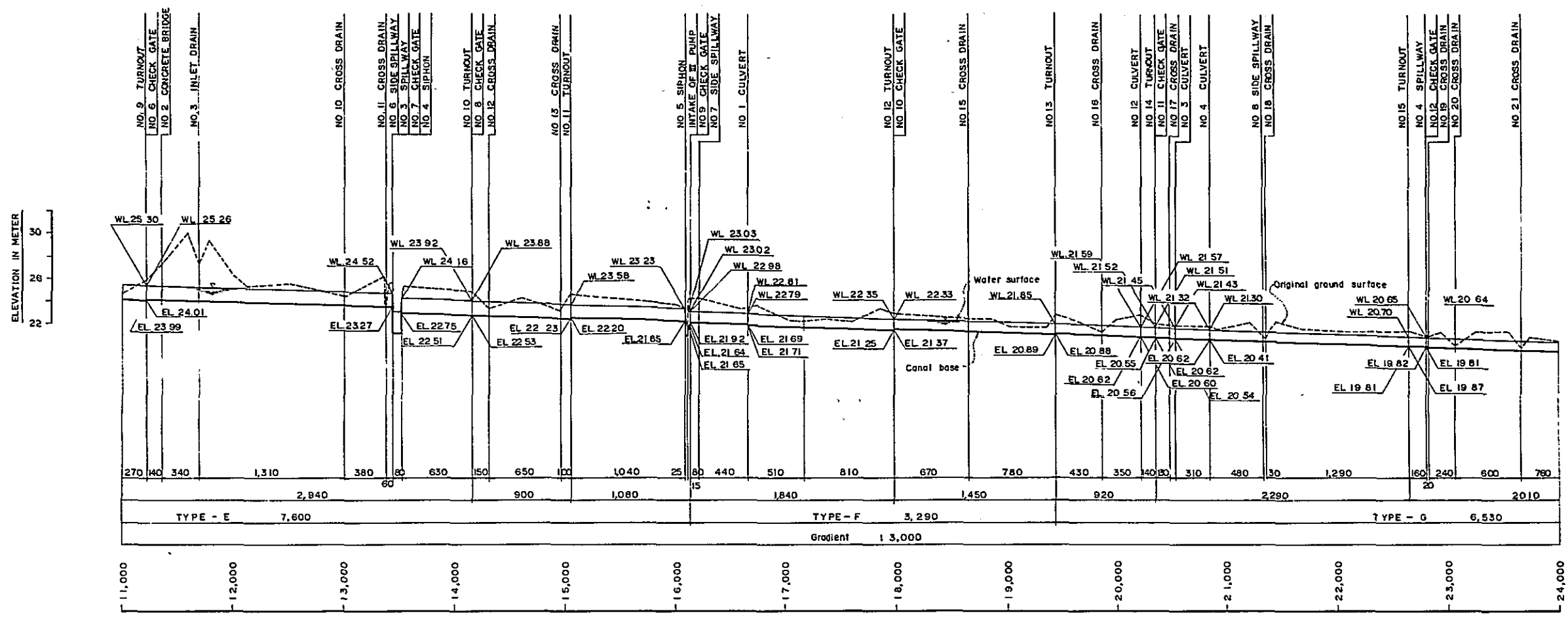

TYPICAL SECTION OF MAIN CANAL

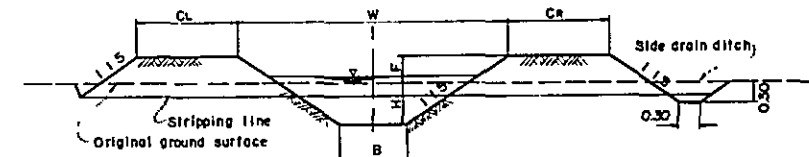

NOTE Side drain ditch will be constructed on the side where the crest width is 2.00m

CANAL	TYPE	DISCHARGE (m ³ /s)	VELOCITY (m/s)	DIMENSION (m)					
				B	H	F	w	C ₁ C ₂	
I H	E	4.00	0.55	4.00	1.24	0.48	0.40	2.00	3.00
	F	1.88	0.47	2.00	1.10	0.40	0.50	•	•
	G	1.20	0.42	1.50	0.97	0.43	0.570	•	•
	H	0.61	0.35	1.50	0.69	0.31	0.50	•	•
	I	0.30	0.29	1.00	0.55	0.45	0.40	•	•
	K	0.13	0.24	0.75	0.41	0.29	0.285	•	•
L	0.04	0.16	0.50	0.26	0.24	0.200	•	•	

OVERSEAS TECHNICAL COOPERATION AGENCY
 TOKYO
 PHAN HANG AGRICULTURAL DEVELOPMENT PROJECT, VIET NAM
**PROFILE AND TYPICAL CROSS SECTION
 OF MAIN IRRIGATION CANAL, II-8**
 CONSULTING ENGINEERS
 NIPPON KOKI CO., LTD. TOKYO
 DRAWN: *H. Gaki*
 CHECKED: *K. Mada*
 SUBMITTED: *K. Yoshida*
 APPROVED: _____
 DATE: MAR. 10, 1972
 II-6

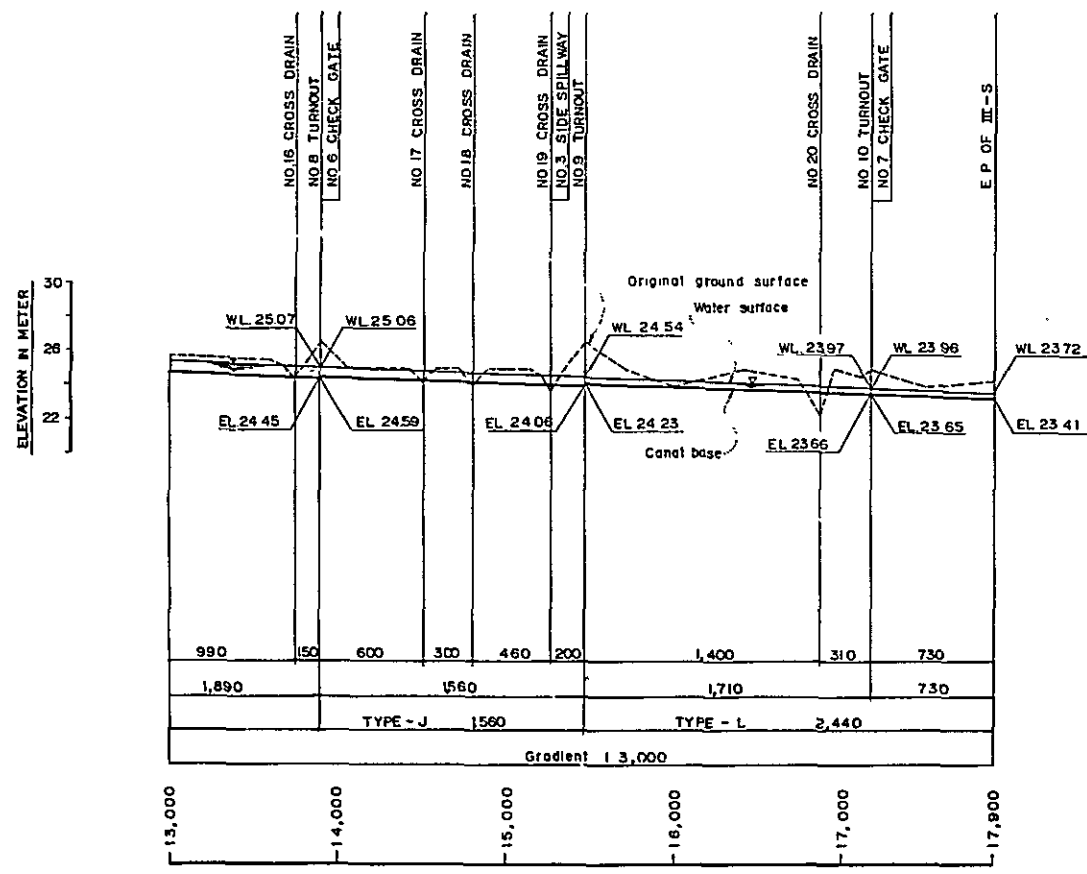
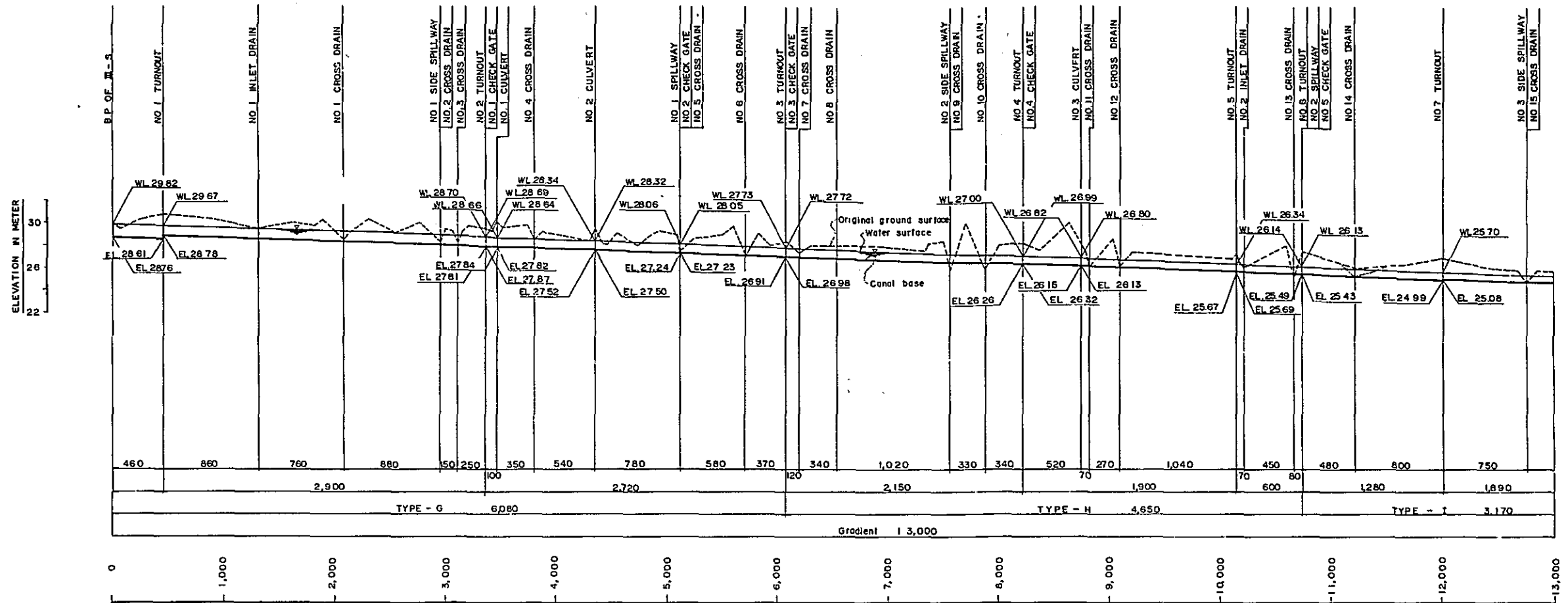

TYPICAL SECTION OF MAIN CANAL

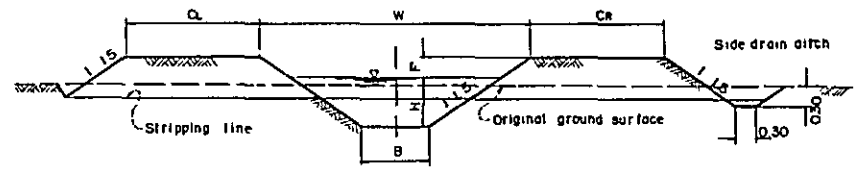

NOTE: Side drain ditch will be constructed on the side where the crest width is 2.00m

CANAL TYPE	DISCHARGE (m ³ /s)	VELOCITY (m/s)	DIMENSION (m)					
			B	H	F	W	Cr	CL
G	1.14	0.44	1.50	1.08	0.34	5.70	3.00	2.00
H	0.70	0.36	1.50	0.74	0.26	4.60	-	-
I	0.49	0.34	1.00	0.71	0.26	4.00	-	-
J	0.23	0.27	1.00	0.48	0.22	3.10	-	-
L	0.06	0.20	0.50	0.31	0.19	2.00	-	-

OVERSEAS TECHNICAL COOPERATION AGENCY
TOKYO

PHAN RANG AGRICULTURAL DEVELOPMENT PROJECT, VIET NAM
PROFILE AND TYPICAL CROSS SECTION OF MAIN IRRIGATION CANAL, III - 8

CONSULTING ENGINEERS
NIPPON KOEI CO., LTD. TOKYO

DRAWN: *[Signature]*
CHECKED: *K. Maeda*
SUBMITTED: *[Signature]*
APPROVED: *[Signature]*

DATE: MAR. 10, 1972
II - 7

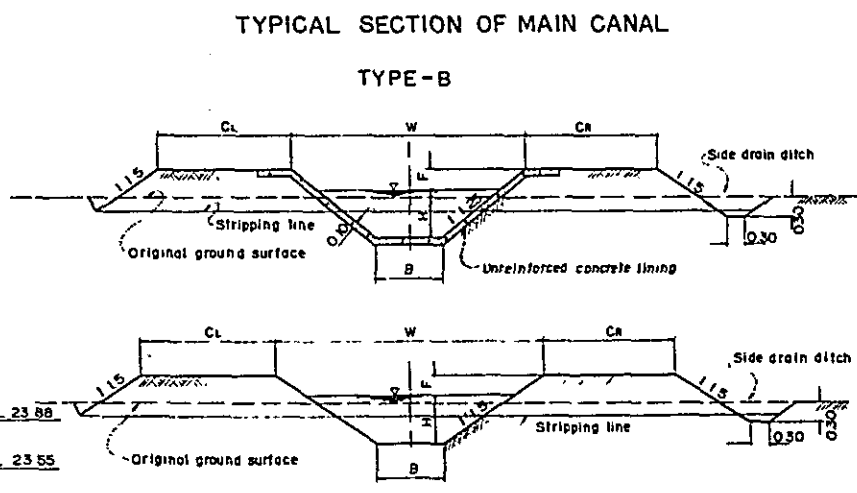
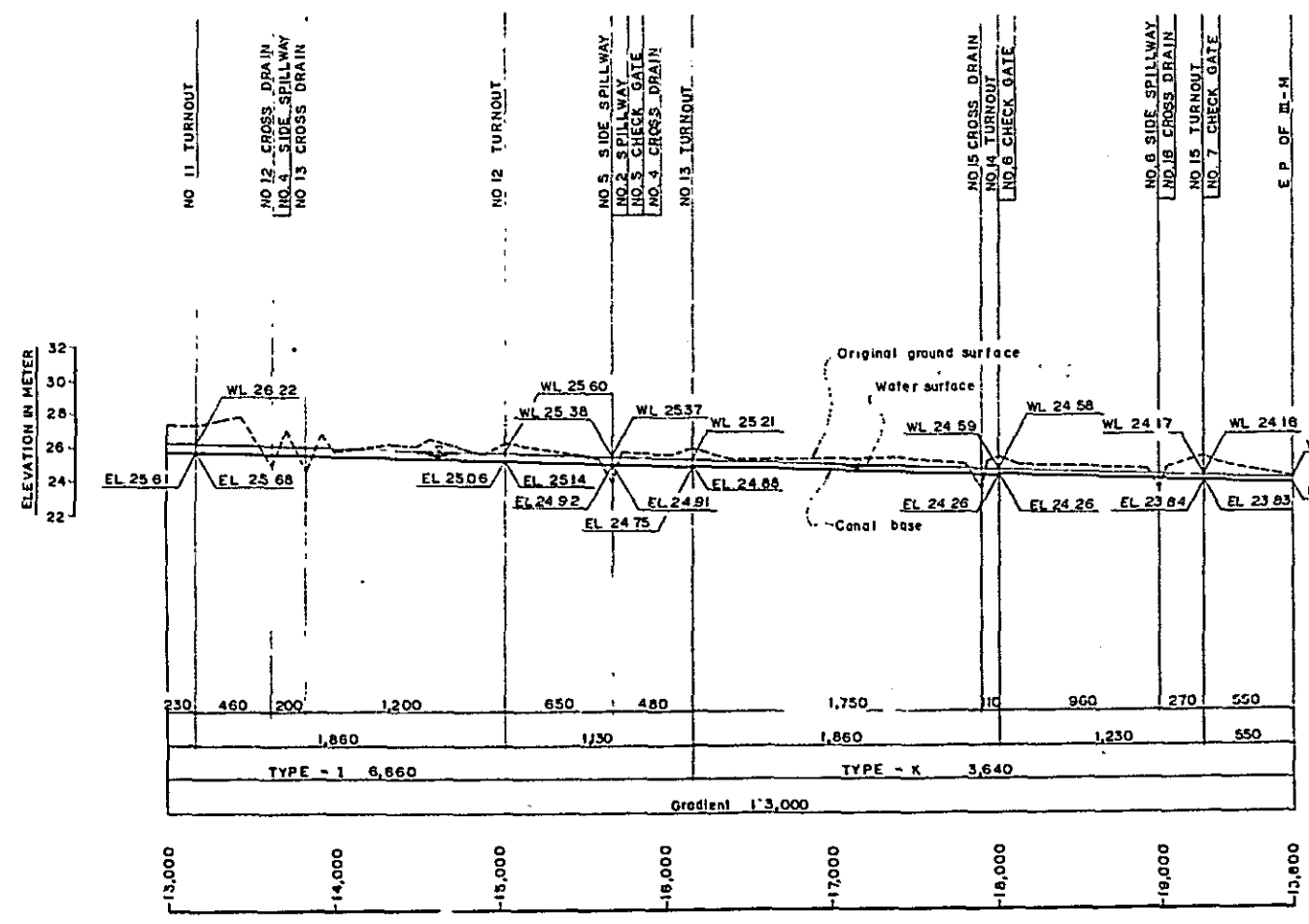
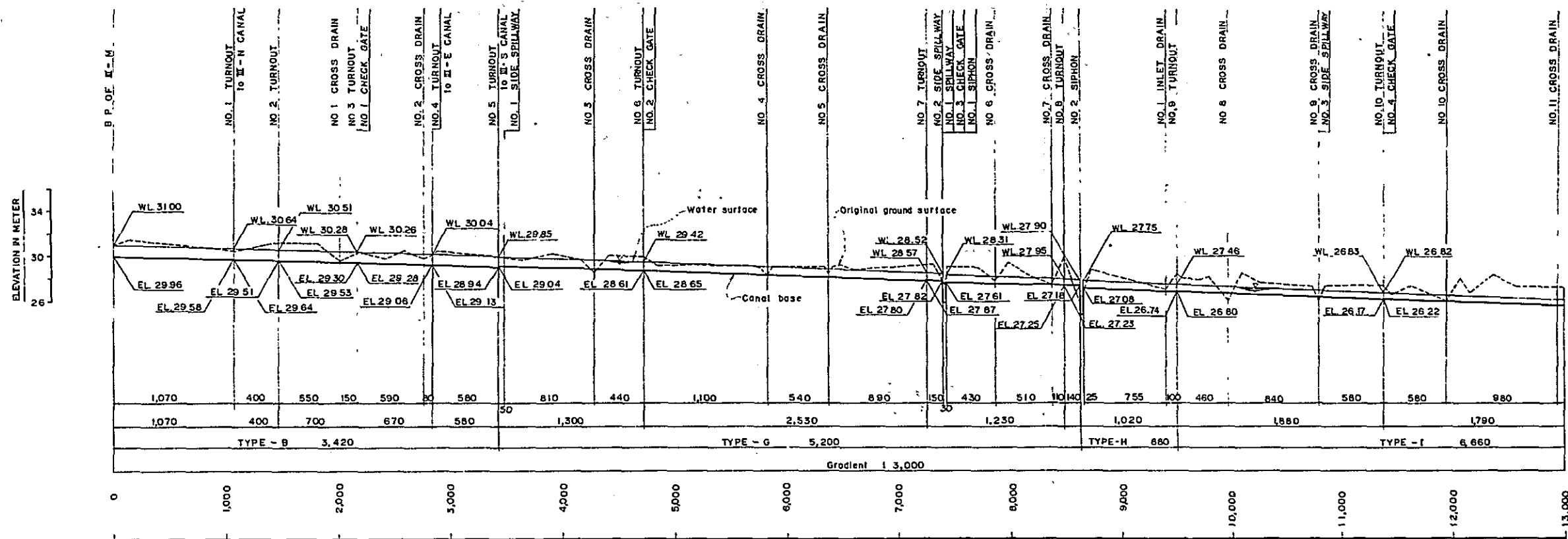

NOTE: Side drain ditch will be constructed on the side where the crest width is 2.00m

CANAL TYPE	DISCHARGE (m³/s)	VELOCITY (m/s)	DIMENSION (m)					
B	299	0.65	B	H	F	W	Ca	Cl
G	102	0.40	1.50	0.90	0.50	0.570		
H	0.64	0.35	1.50	0.70	0.30	0.450		
I	0.50	0.34	1.00	0.72	0.26	0.400		
K	0.17	0.26	0.75	0.46	0.24	0.265		

OVERSEAS TECHNICAL COOPERATION AGENCY
 TOKYO
 PHAN RANG AGRICULTURAL DEVELOPMENT PROJECT, VIET NAM
PROFILE AND TYPICAL CROSS SECTION OF MAIN IRRIGATION CANAL, III-M
 CONSULTING ENGINEERS
 NIPPON KOEI CO., LTD. TOKYO

DRAWN: *A. Gyll*
 CHECKED: *K. Maeda*
 SUBMITTED: *R. Yoshida*
 APPROVED: _____

DATE: MAR. 21, 1974
 II-8

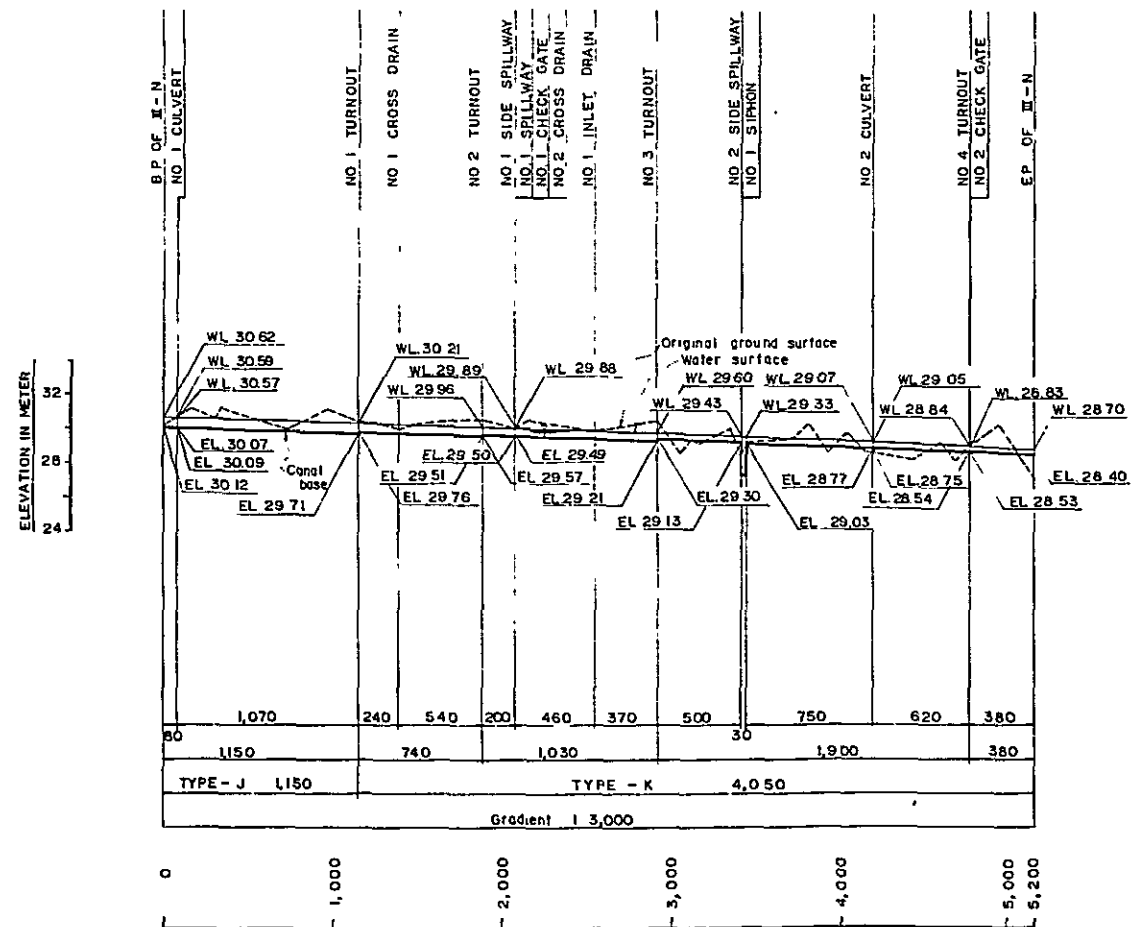
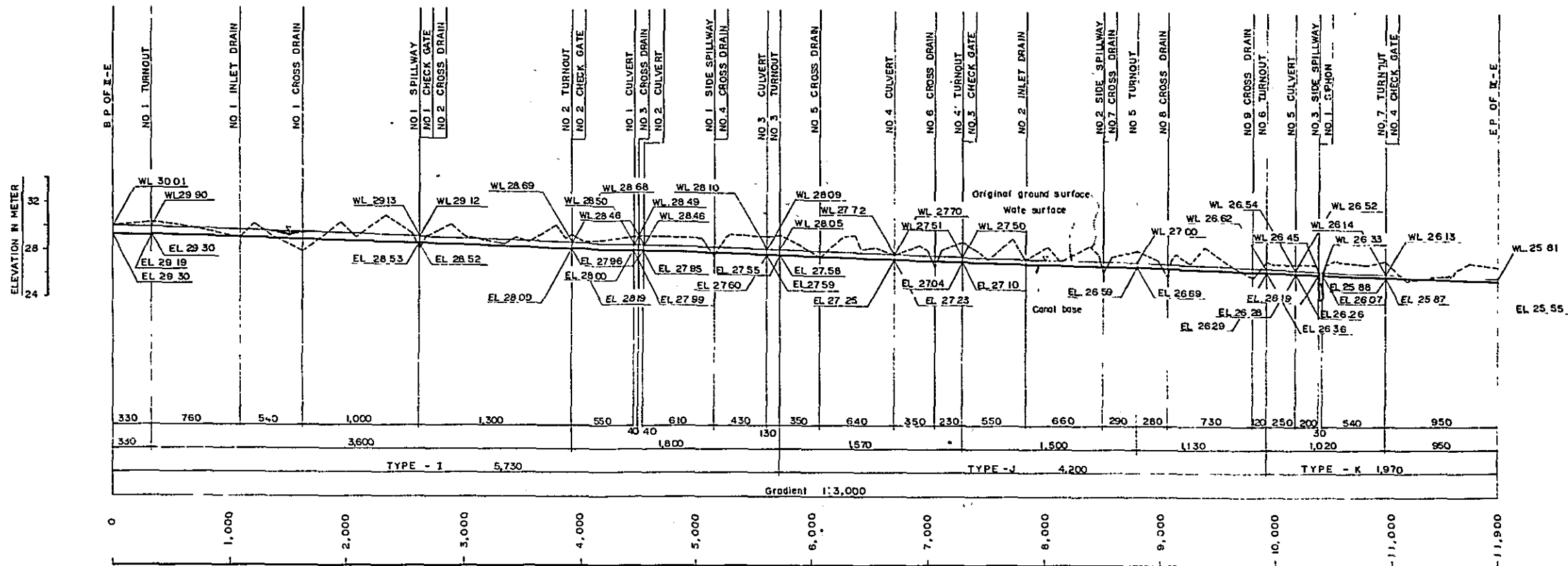

TYPICAL SECTION OF MAIN CANAL

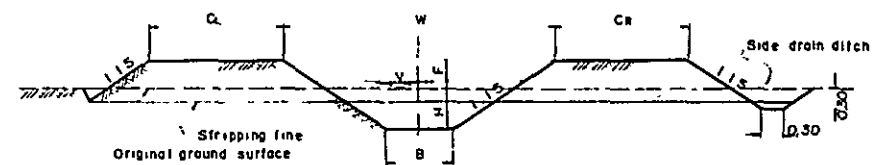

NOTE Side drain ditch will be constructed on the side where the crest width is 2.00 m

CANAL	CANAL TYPE	DISCHARGE (m ³ /s)	VELOCITY (m/s)	DIMENSION (m)			
				B	H	F	W
I	J	0.50	0.54	1.00	0.71	0.29	4.00
	K	0.22	0.27	1.00	0.47	0.23	3.10
II	J	0.08	0.18	0.75	0.28	0.34	2.95
	K	0.24	0.28	1.00	0.50	0.20	3.10
III	J	0.17	0.25	0.75	0.45	0.25	2.85
	K	0.17	0.25	0.75	0.45	0.25	2.85

OVERSEAS TECHNICAL COOPERATION AGENCY
 TOKYO

PHAN RANG AGRICULTURAL DEVELOPMENT PROJECT, VIET NAM

**PROFILE AND TYPICAL CROSS SECTION
 OF MAIN IRRIGATION CANAL, E-E-H-H**

CONSULTING ENGINEERS
 NIPPON KOGI CO., LTD. TOKYO

DRAWN *K. Maeda*
 CHECKED *K. Maeda*
 SUBMITTED *R. Yoshida*
 APPROVED

DATE: MAR. 10, 1972.

II-9

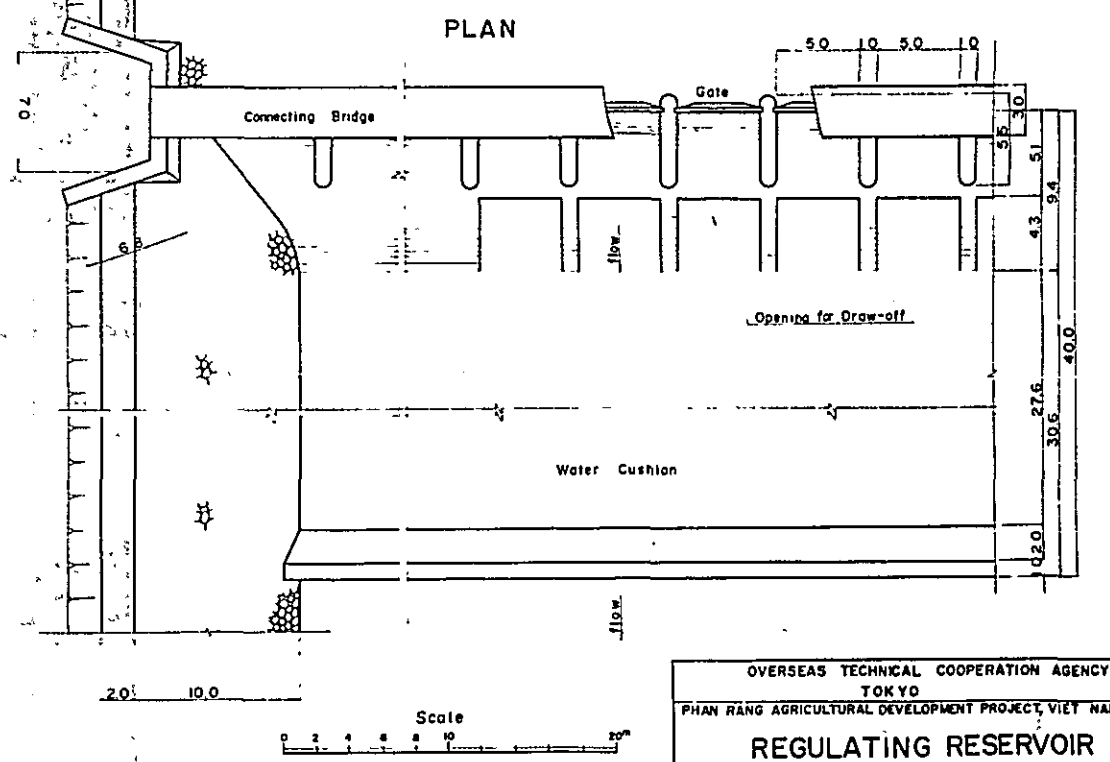
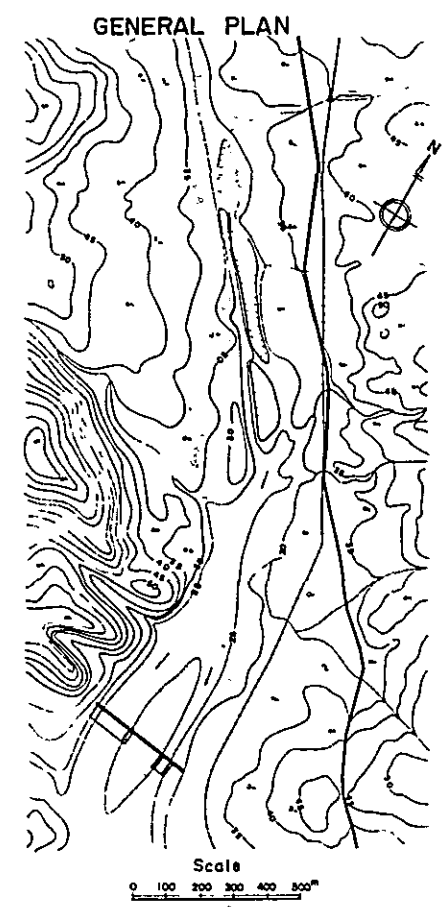
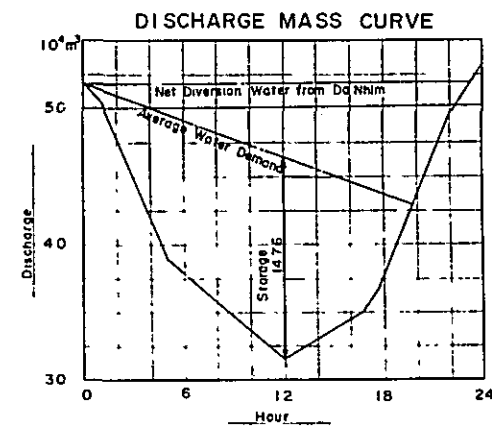
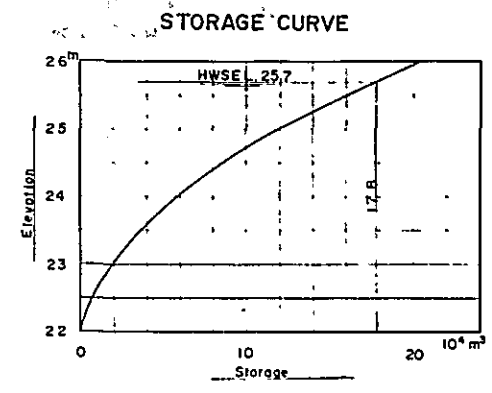
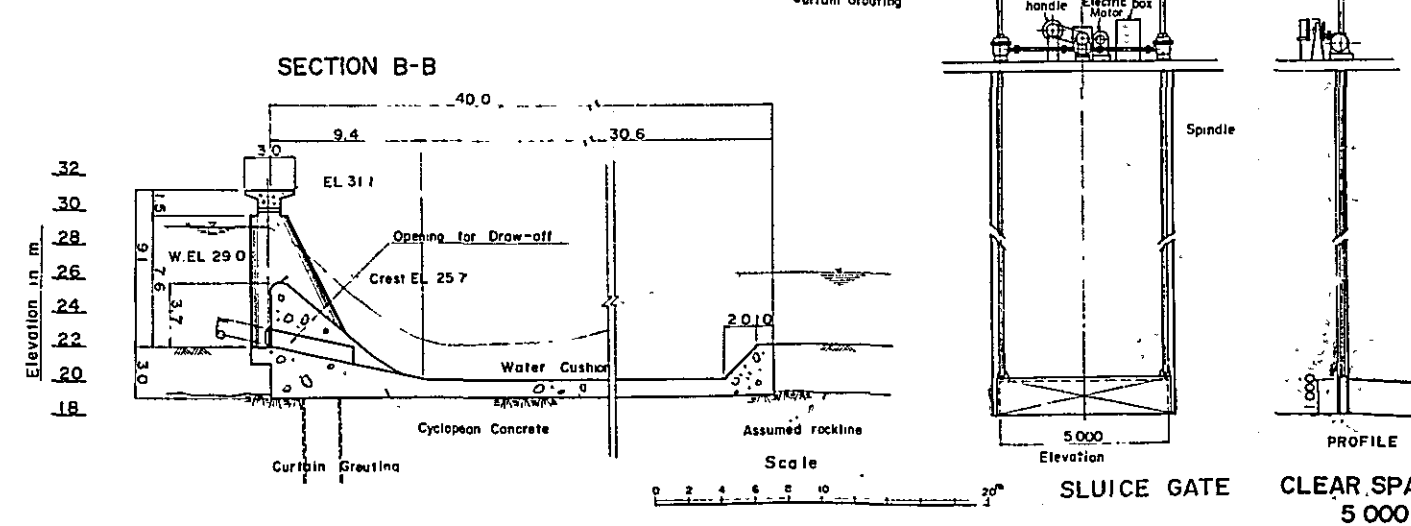
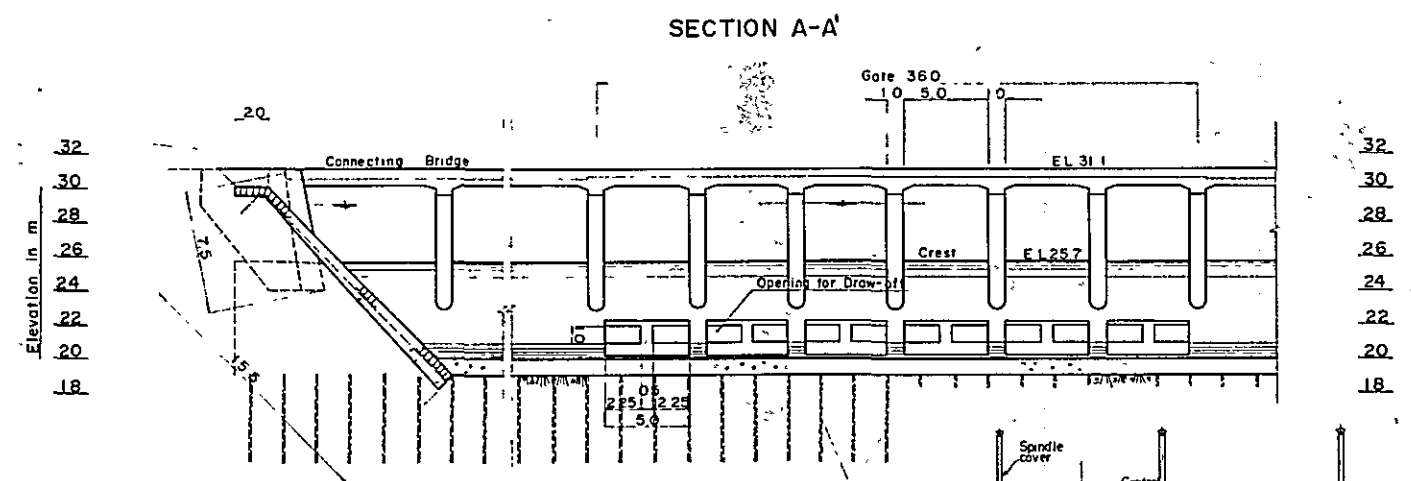
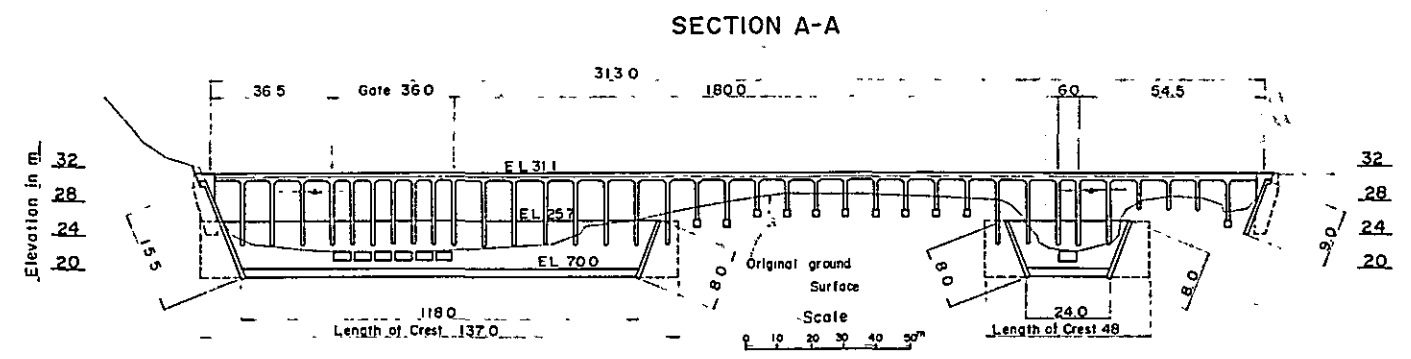
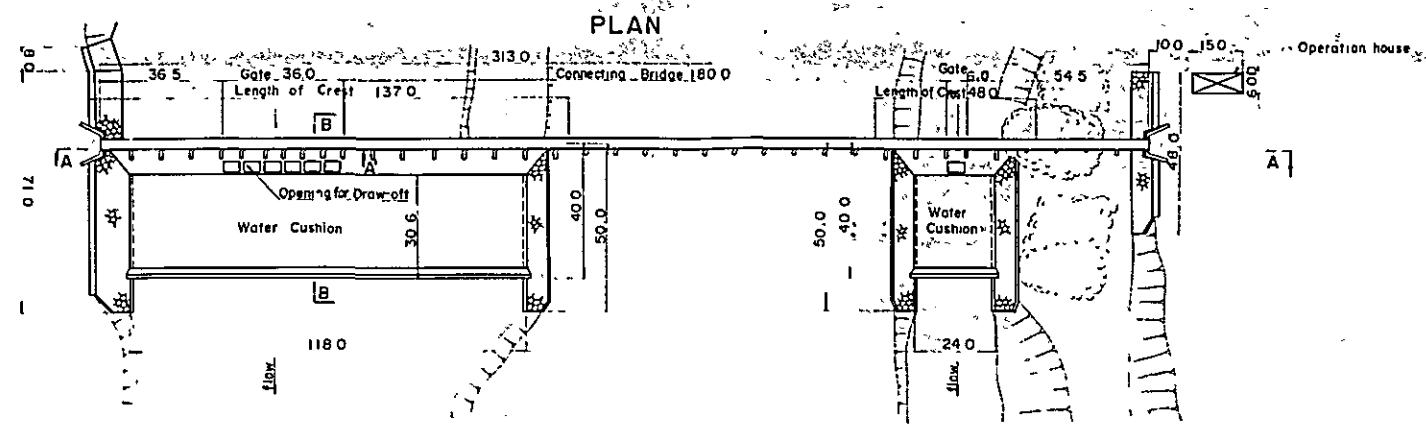

OVERSEAS TECHNICAL COOPERATION AGENCY
TOKYO

PHAN RANG AGRICULTURAL DEVELOPMENT PROJECT, VIET NAM

REGULATING RESERVOIR

CONSULTING ENGINEERS
NIPPON KOEI CO., LTD. TOKYO

DRAWN *K. Crabbe*
CHECKED *K. Maeda*
SUBMITTED *R. Yoshida*
APPROVED

DATE MAR 10, 1972
DRAW. NO. II-10

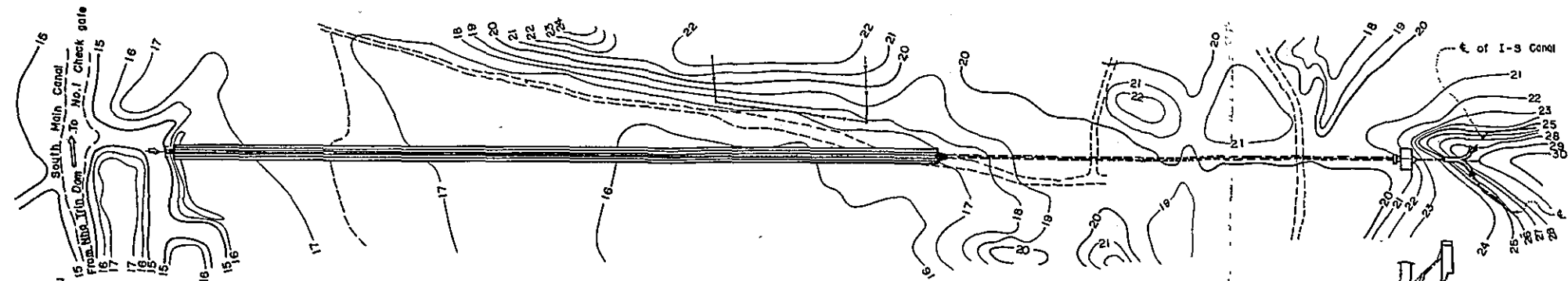

LOCATION OF PUMPING SITE

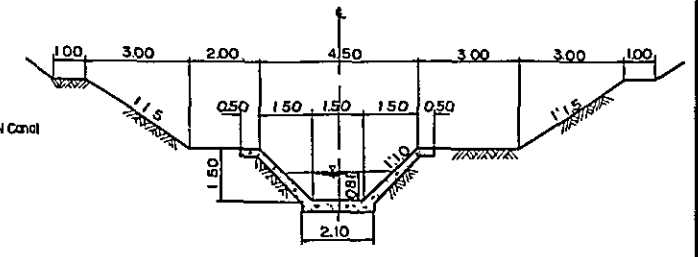
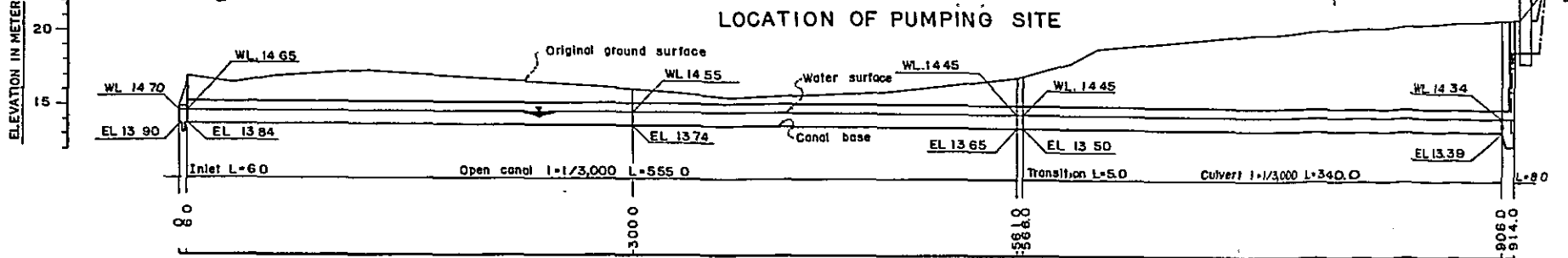

TYPICAL SECTION OF OPEN CANAL

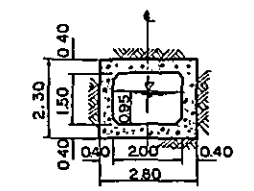

TYPICAL SECTION OF CULVERT

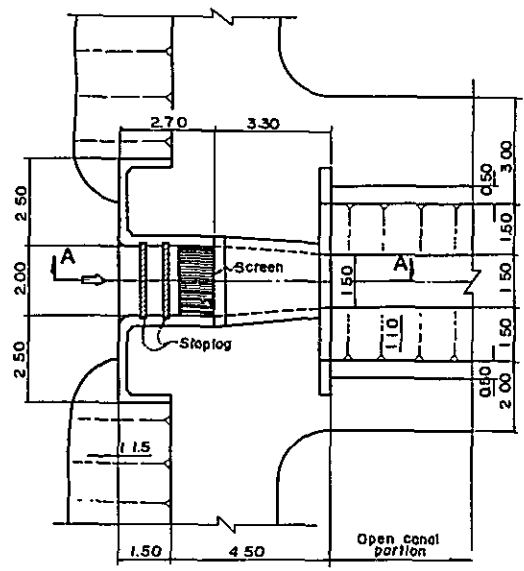

PLAN OF INLET

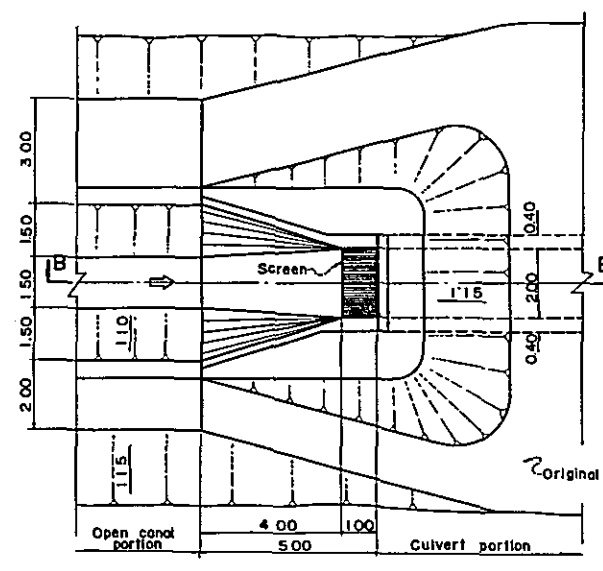

PLAN OF TRANSITION

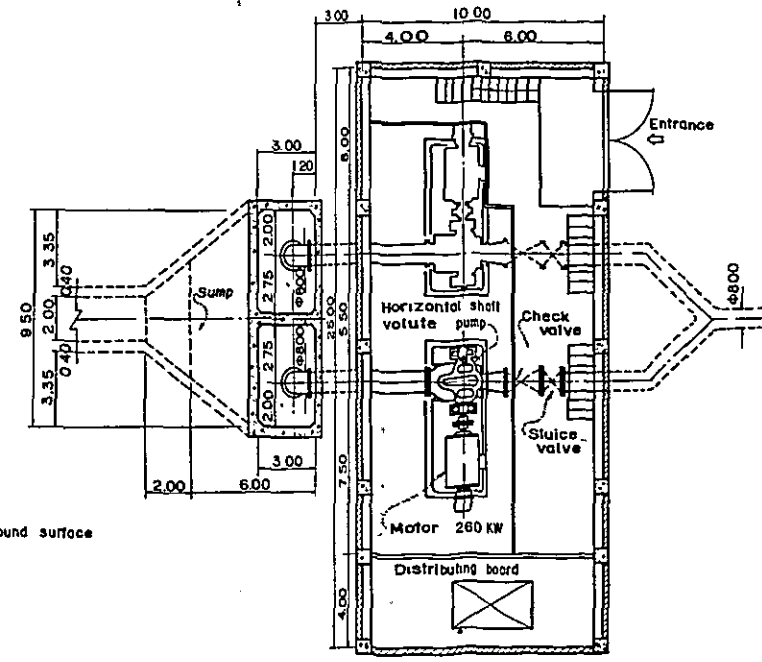

PLAN OF PUMPING HOUSE

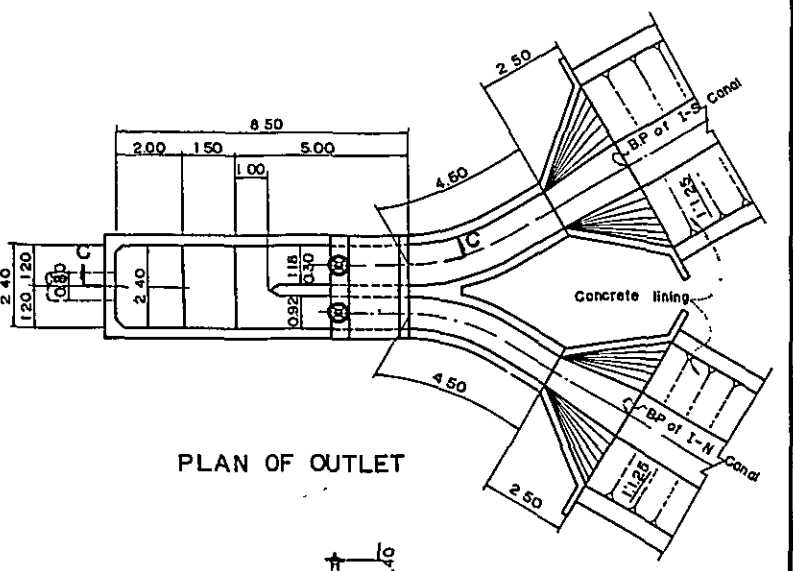

PLAN OF OUTLET

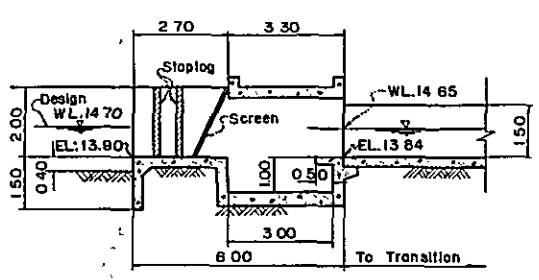

SECTION A-A

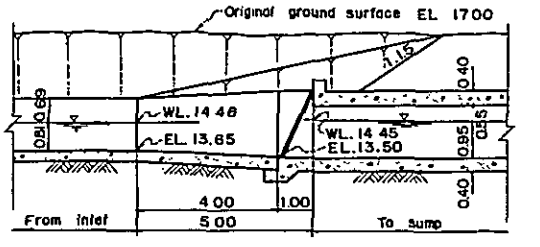

SECTION B-B

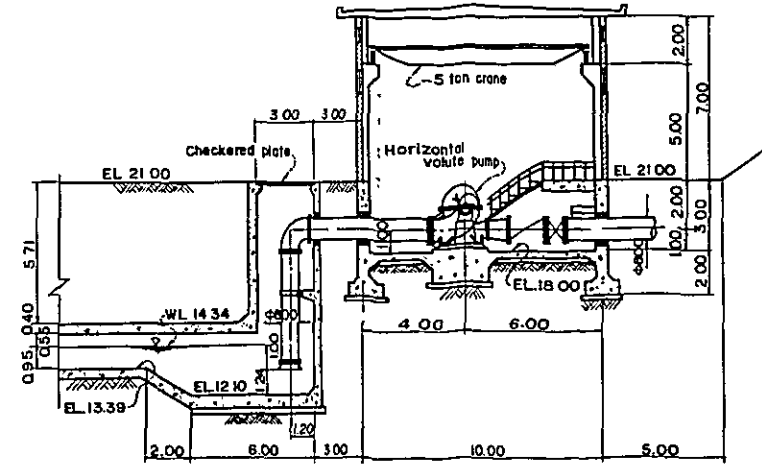

PROFILE

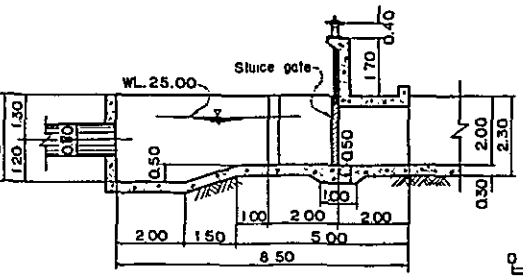

SECTION C-C

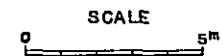

SCALE

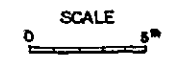

SCALE

OVERSEAS TECHNICAL COOPERATION AGENCY TOKYO	
PHAN RANG AGRICULTURAL DEVELOPMENT PROJECT, VIET NAM	
NO. 1 PUMPING STATION	
CONSULTING ENGINEERS NIPPON KOEI CO., LTD. TOKYO	
DRAWN <i>K. Goto</i>	DATE MAR. 10, 1972
CHECKED <i>K. Maeda</i>	II-11
SUBMITTED <i>K. Goto</i>	
APPROVED	

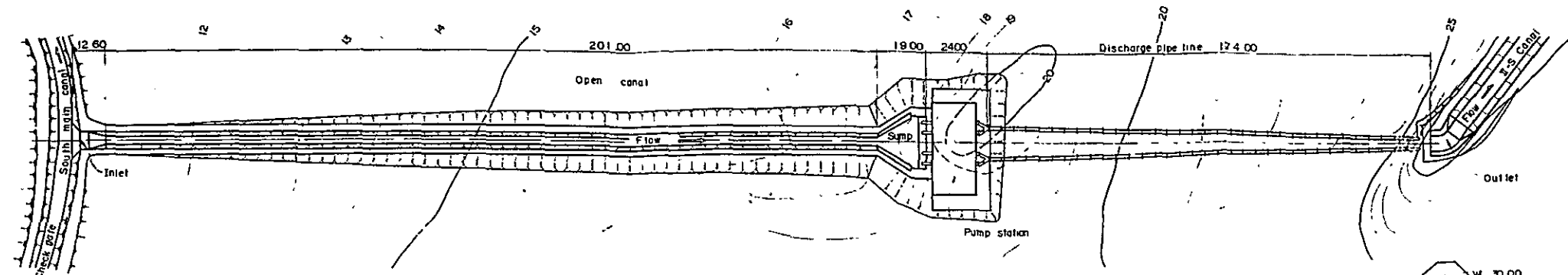

LOCATION OF PUMPING SITE

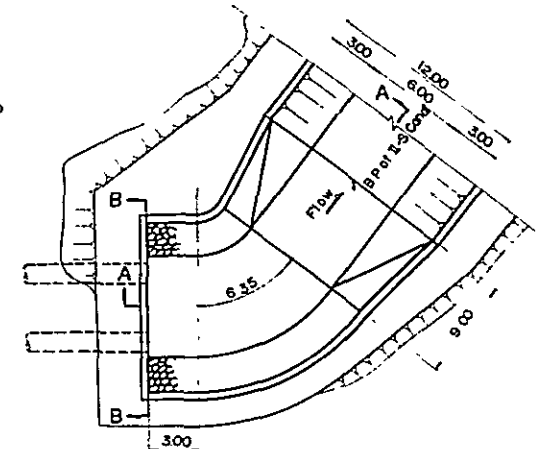

PLAN OF OUTLET

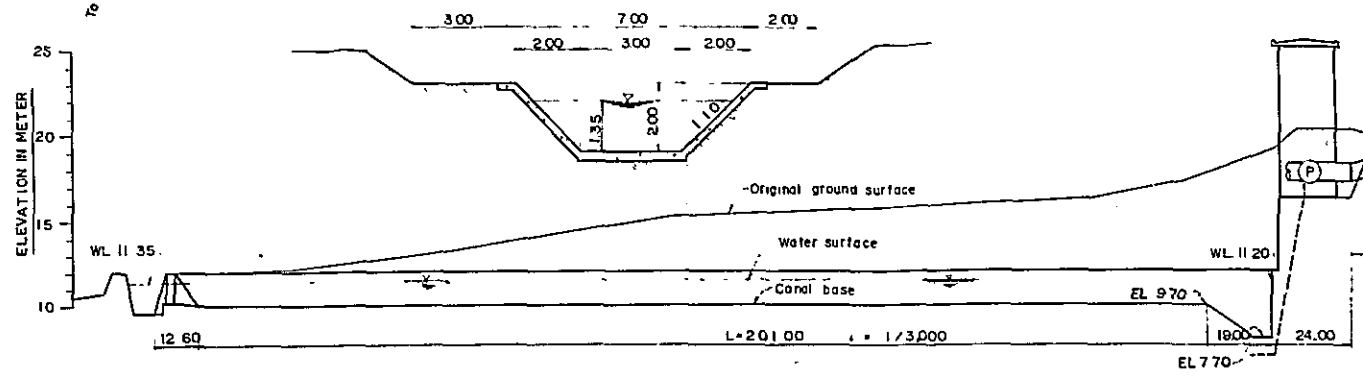

ELEVATION IN METER

WL 11.35

EL 9.70

EL 7.70

L=201.00 1/3.000

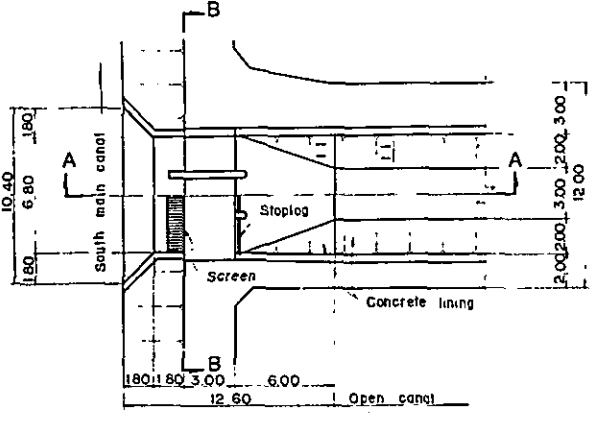

PLAN OF INLET

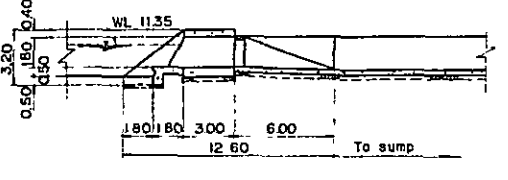

SECTION A-A

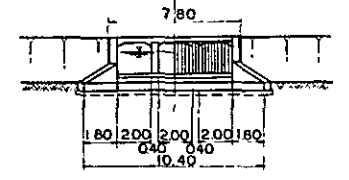

SECTION B-B

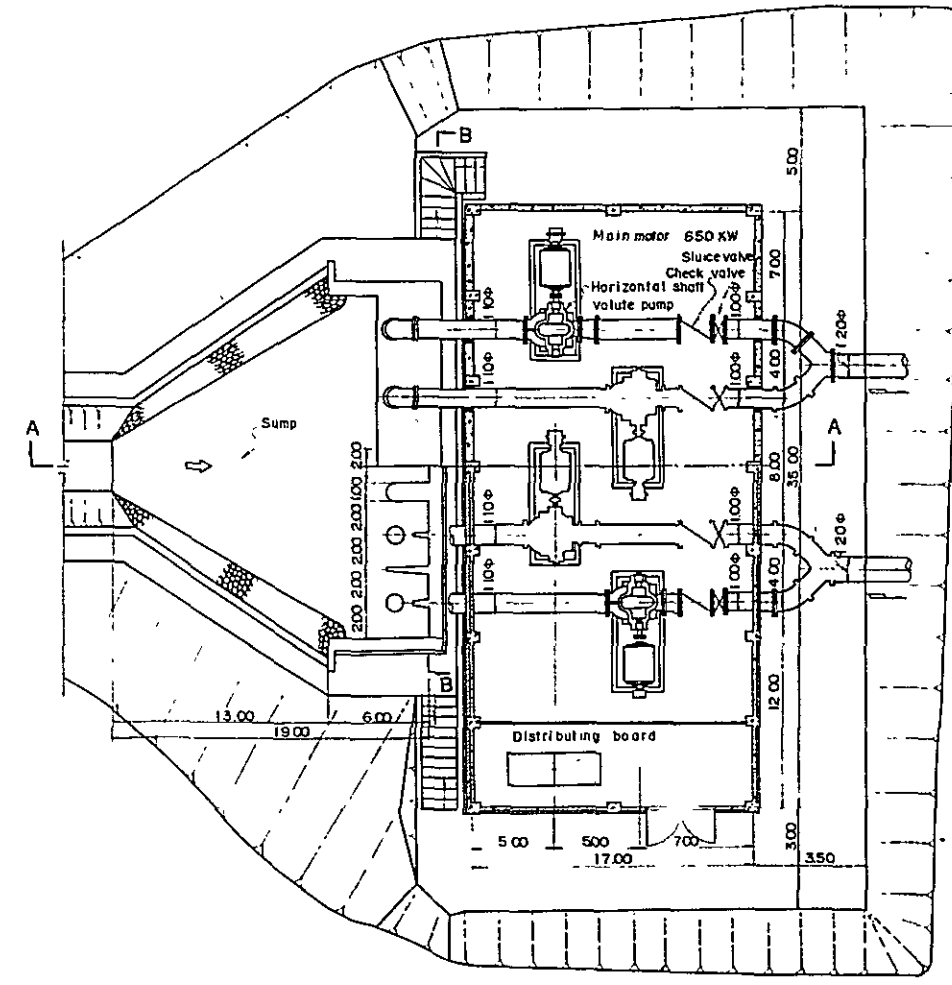

PLAN OF PUMPING HOUSE

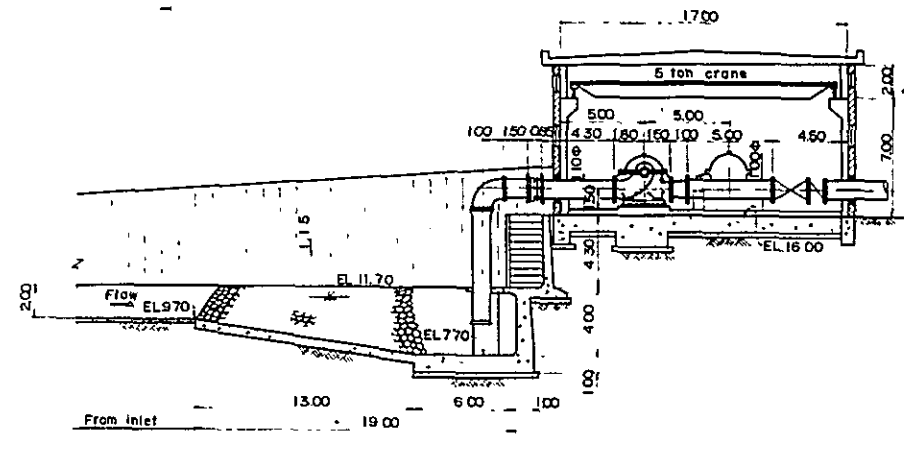

SECTION A-A

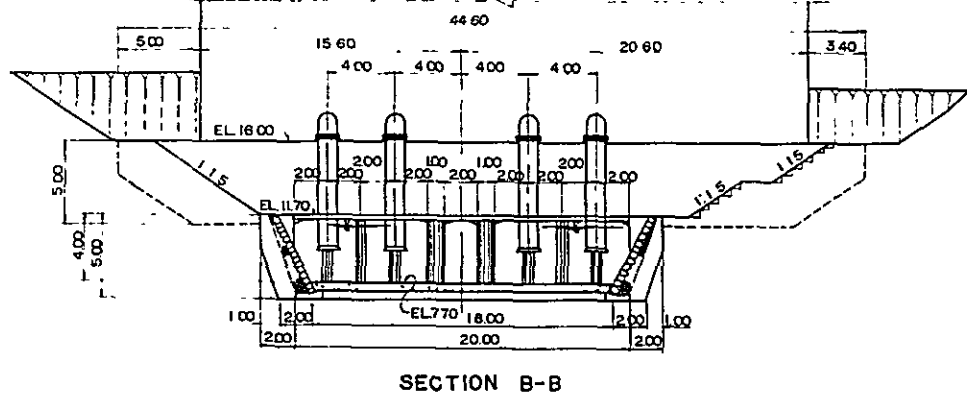

SECTION B-B

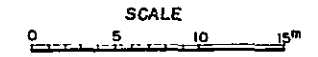

SCALE

OVERSEAS TECHNICAL COOPERATION AGENCY TOKYO	
PHAN RANG AGRICULTURAL DEVELOPMENT PROJECT, VIET NAM	
NO.2 PUMPING STATION	
CONSULTING ENGINEERS NIPPON KOGI CO., LTD. TOKYO	
DRAWN <i>K. Goto</i>	DATE MAY 10, 1972
CHECKED <i>K. Maeda</i>	II-12
SUBMITTED <i>R. Yoshida</i>	
APPROVED	

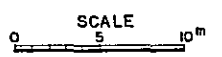

SCALE

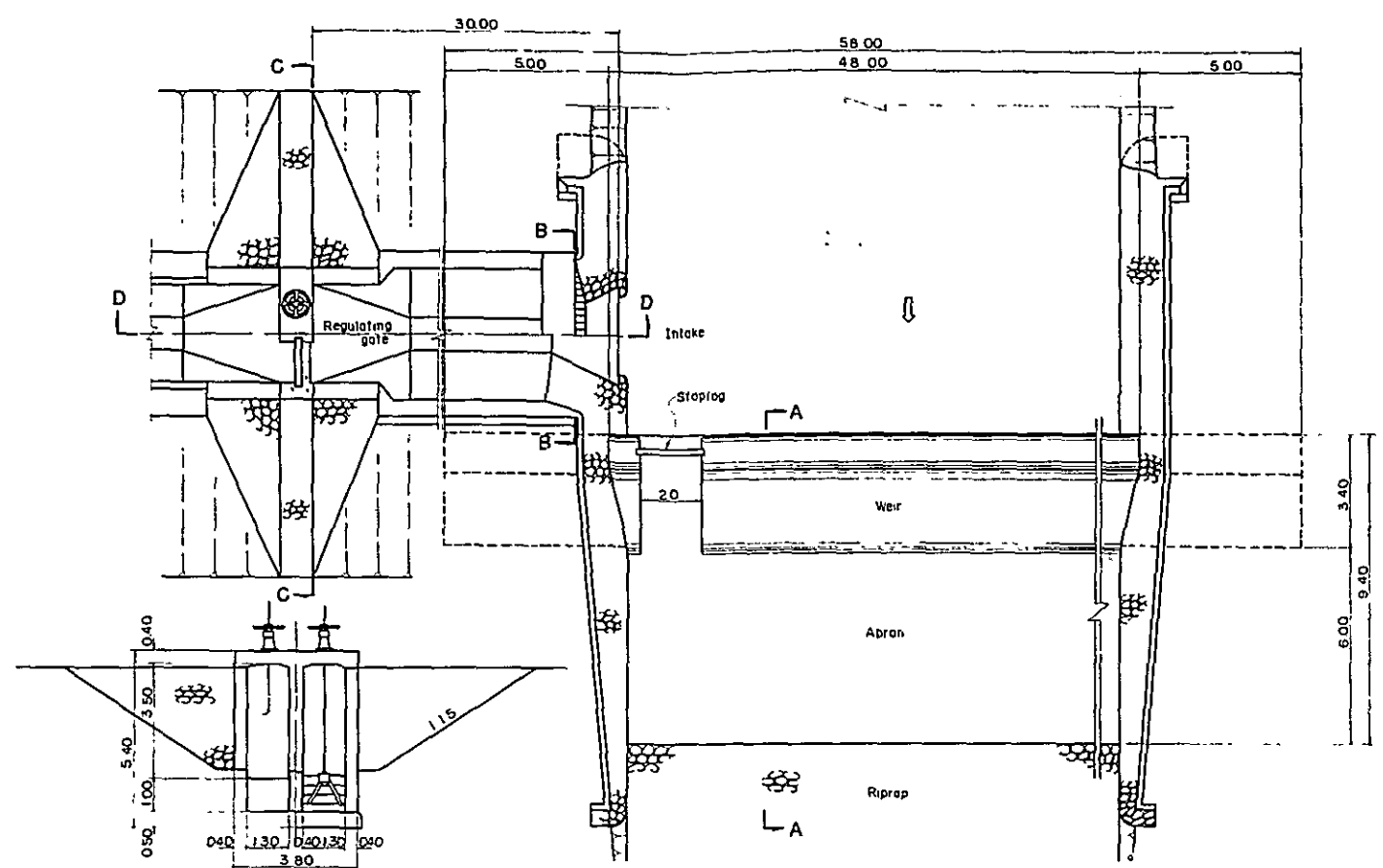

SECTION C-C

PLAN

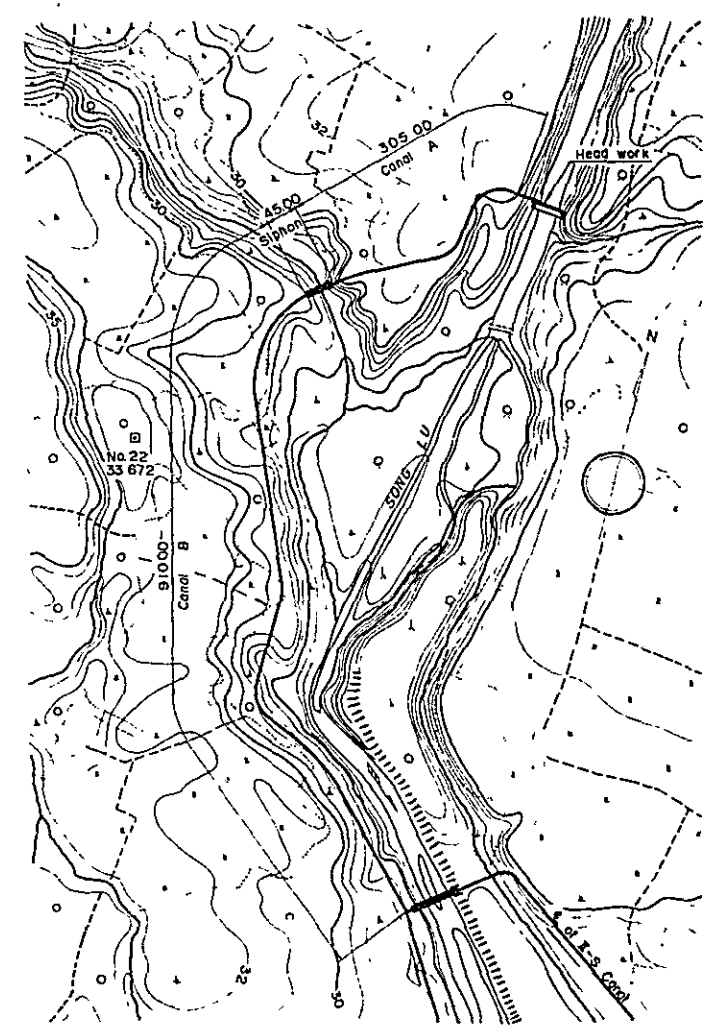

GENERAL PLAN

SCALE 0 100 200 300m

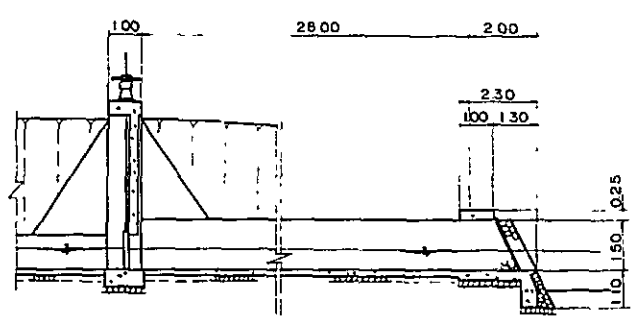

SECTION D-D

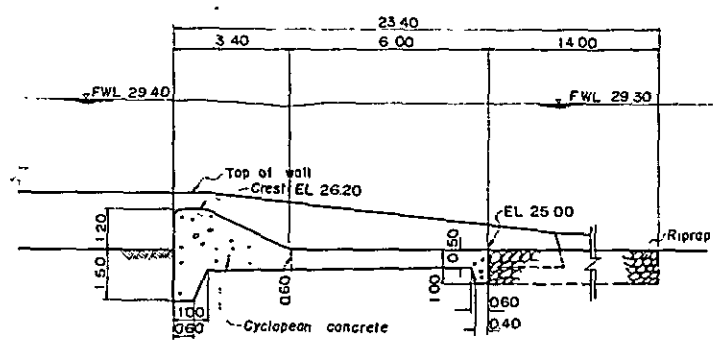

SECTION A-A

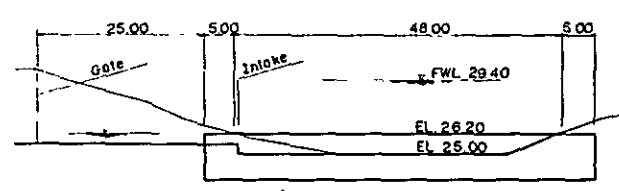
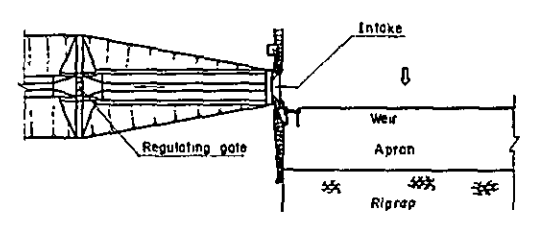

SCALE 0 10 20m

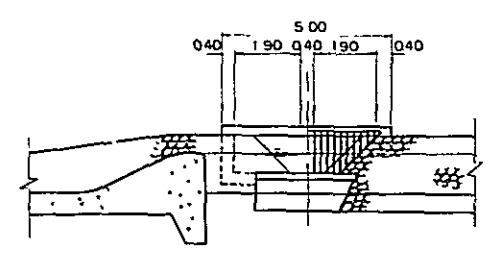

SECTION B-B

SCALE 0 5m

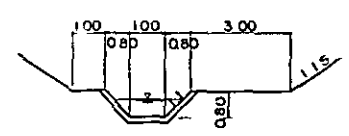

CANAL A SECTION

SCALE 0 4m

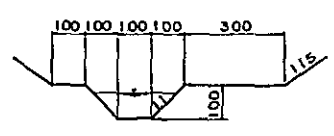

CANAL B SECTION

OVERSEAS TECHNICAL COOPERATION AGENCY TOKYO	
PHAN RANG AGRICULTURAL DEVELOPMENT PROJECT, VIET NAM	
INTAKE STRUCTURE ON THE SONG LU	
CONSULTING ENGINEERS NIPPON KOEI CO., LTD. TOKYO	
DRAWN <i>Y. Maeda</i>	DATE MAR. 15 1972.
CHECKED <i>K. Maeda</i>	II-14
SUBMITTED <i>R. Yoshida</i>	
APPROVED	

TYPE - B, C, D & E

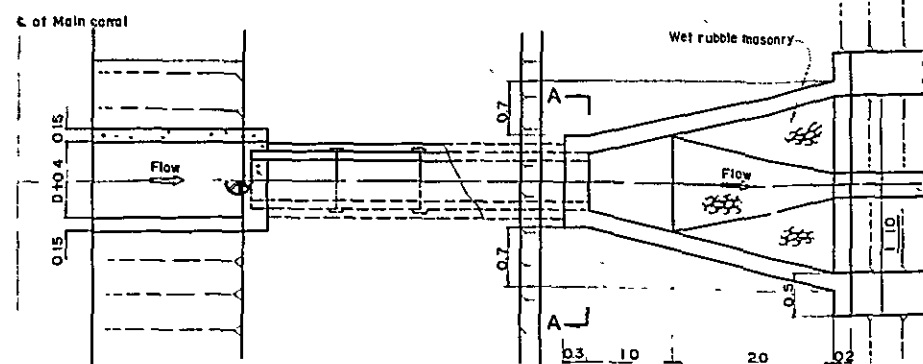

PLAN

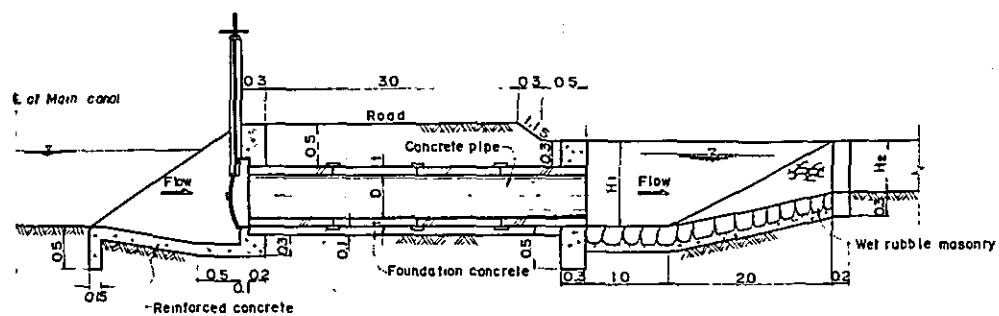

PROFILE
TYPE - A

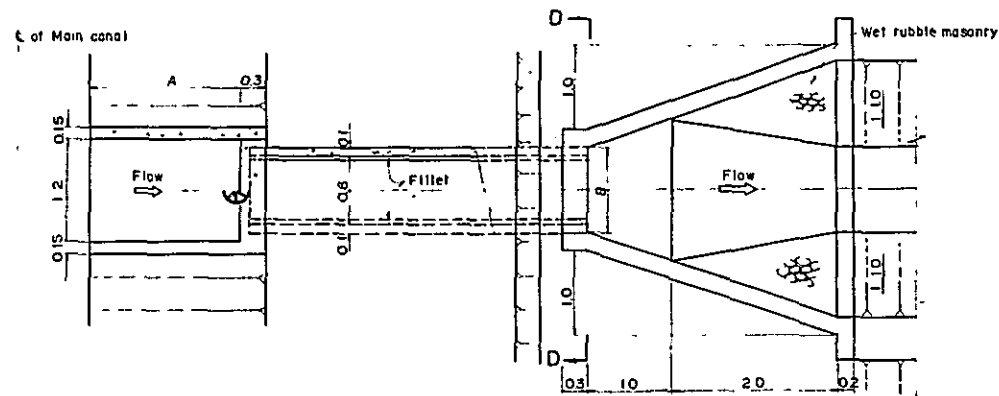
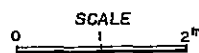

PLAN

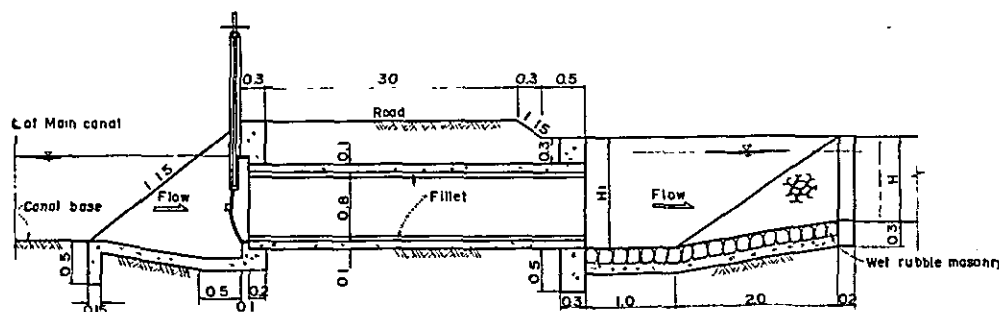

PROFILE

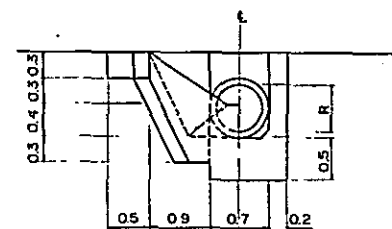

SECTION A - A

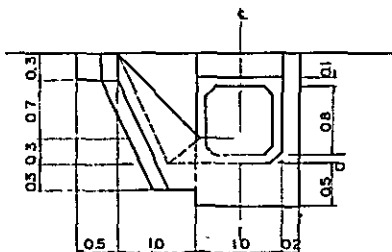

SECTION D - D

TYPE - F

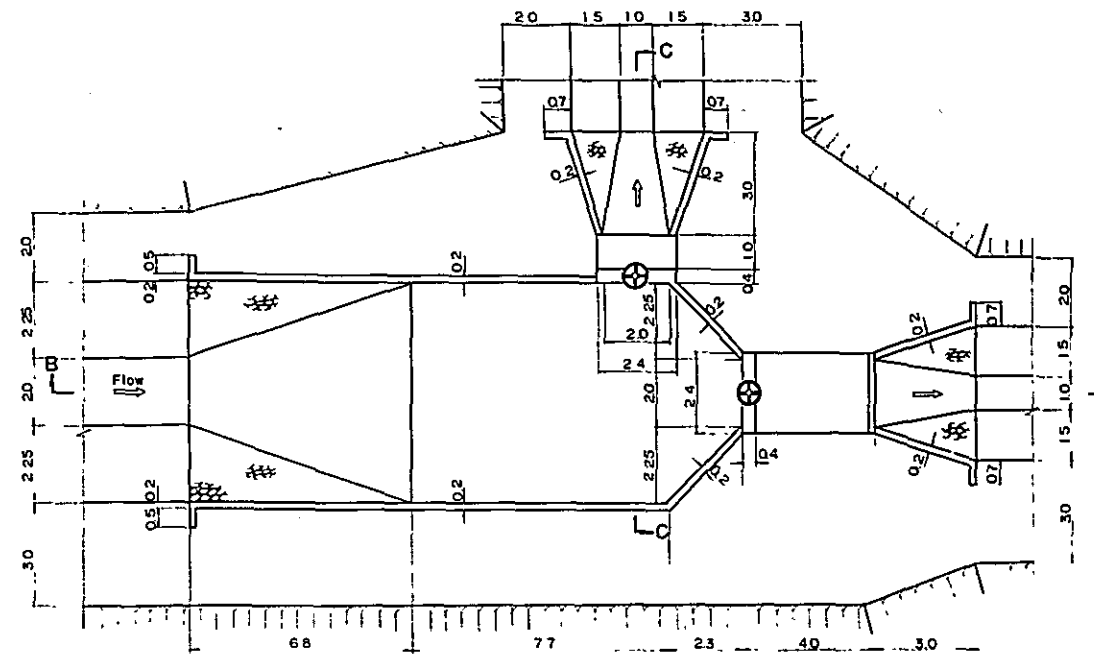

PLAN

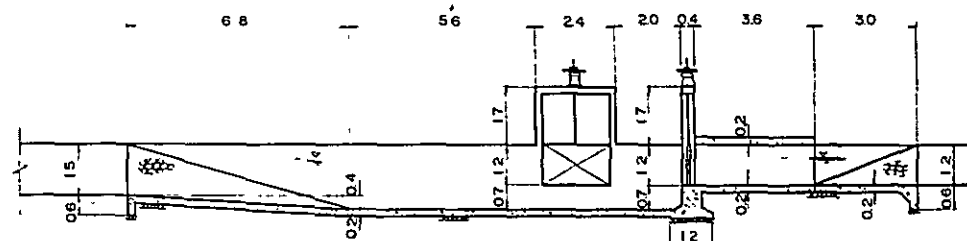

SECTION B - B

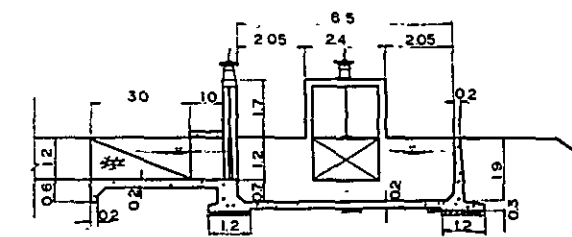
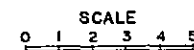

SECTION C - C

REFERENCE DRAWING
CANAL SECTION & DIMENSION --- DRW NO. II-4 to II-9

- NOTE
- TYPE - A Used at points where the diverted discharge is more than 0.60 m³/sec.
 - TYPE - B Used at points where the diverted discharge is more than 0.25 m³/sec pipe ϕ 800
 - TYPE - C Used at points where the diverted discharge is more than 0.15 m³/sec pipe ϕ 600
 - TYPE - D Used at points where the diverted discharge is more than 0.05 m³/sec pipe ϕ 500
 - TYPE - E Used at points where the diverted discharge is less than 0.05 m³/sec. pipe ϕ 300
 - TYPE - F Used at points where the canal bifurcates

OVERSEAS TECHNICAL COOPERATION AGENCY TOKYO	
PHAN RANG AGRICULTURAL DEVELOPMENT PROJECT, VIET NAM	
TYPICAL TURNOUT	
CONSULTING ENGINEERS NIPPON KOEI CO., LTD TOKYO	
DRAWN <i>K. Maeda</i>	DATE: MAR. 10, 1972
CHECKED <i>K. Maeda</i>	
SUBMITTED <i>R. Yoshida</i>	
APPROVED	II - 15

TYPE - A

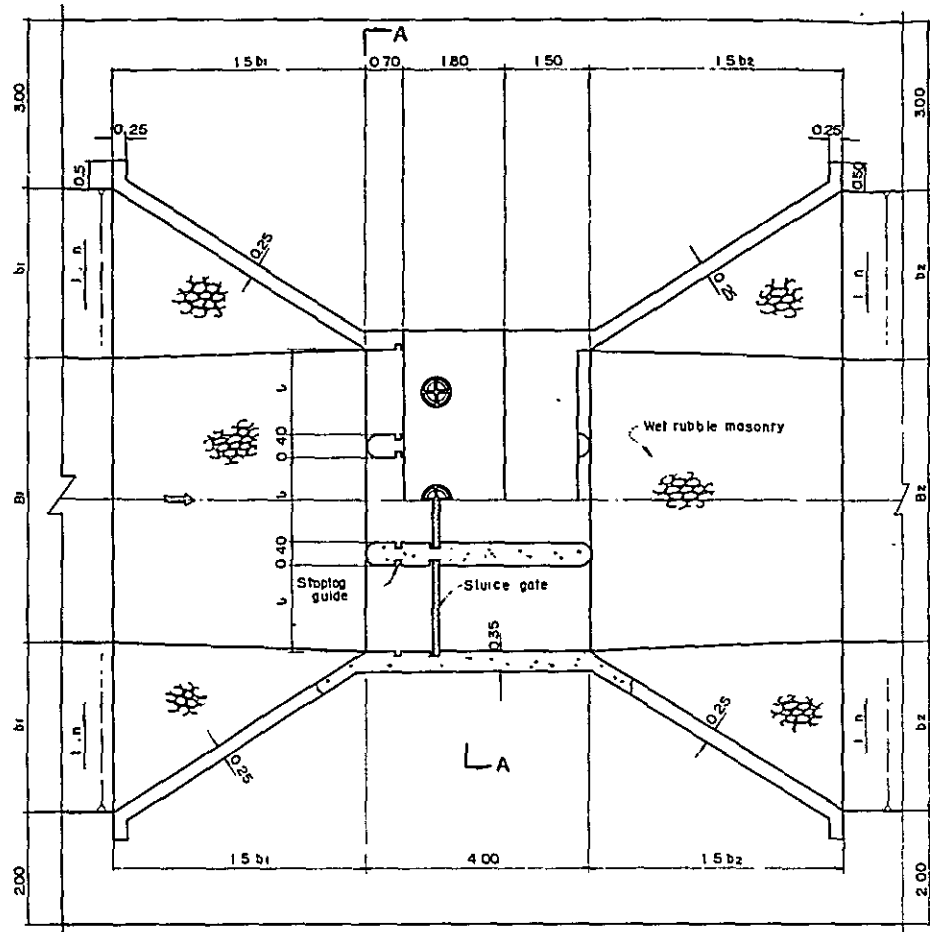

PLAN

NOTE

Dimension of L
Where the downstream canal section
being TYPE - A & D, L = 1.50
Where the downstream canal section
being TYPE - E, L = 1.20

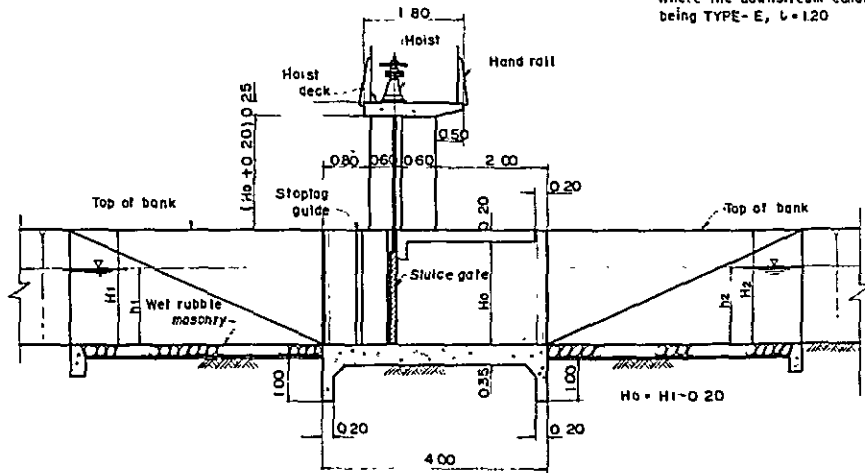

PROFILE

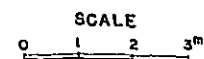

TYPE - B

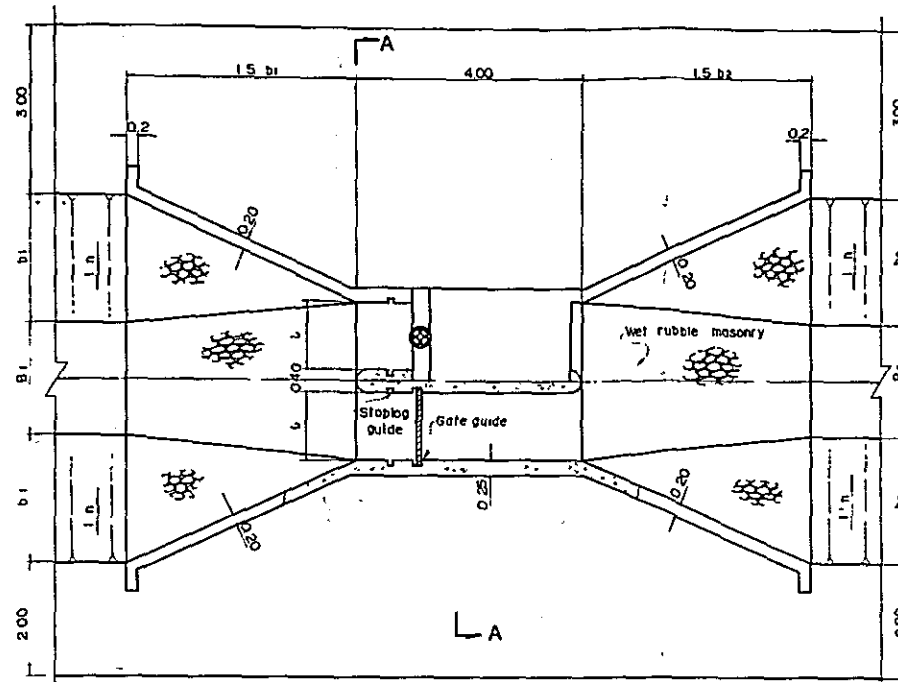

PLAN

NOTE

Dimension of L
Where the downstream canal section
being Type B, L = 1.20
Where the downstream canal section
being Type F, L = 1.00

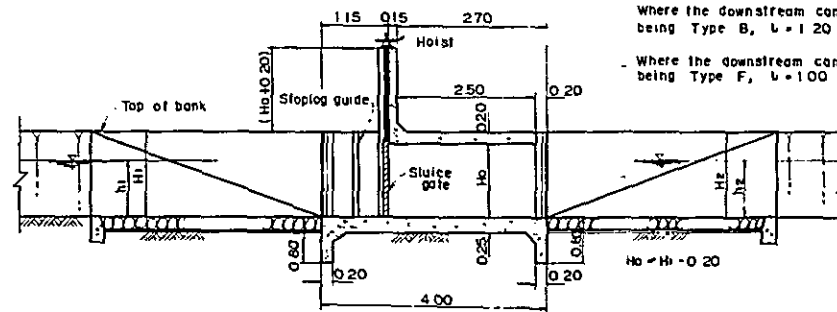

PROFILE

NOTE

TYPE - A Used at points where the canal section
is TYPE - A, TYPE - D & TYPE - E,
TYPE - B Used at points where the canal section
is TYPE - B & TYPE - F
TYPE - C Used at points where the canal section
is TYPE - C, TYPE - G, TYPE - H &
TYPE - I

REFERENCE DRAWING
CANAL SECTION & DIMENSION --- DRW NO II-4
to II-9

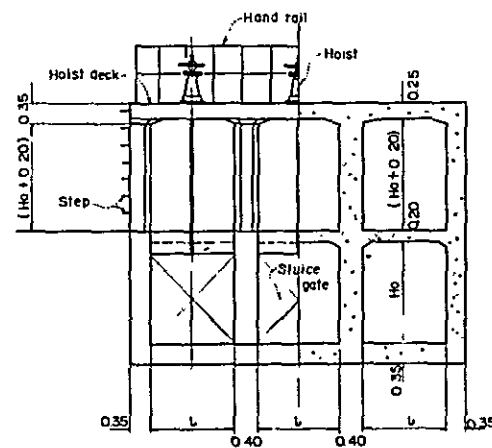

SECTION A-A

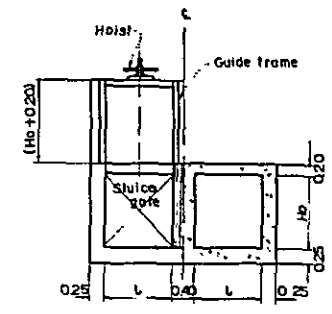

SECTION A-A

TYPE - C

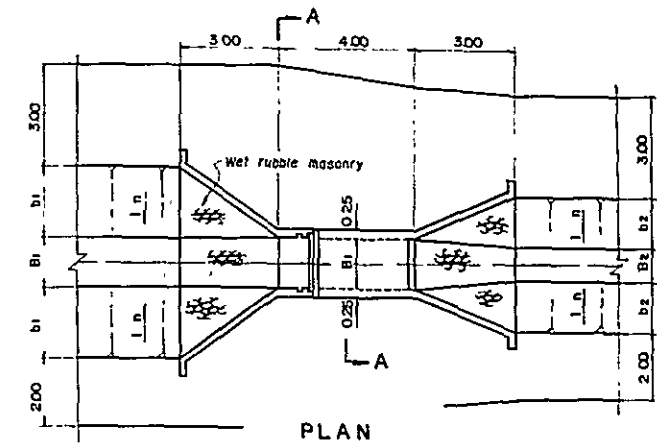

PLAN

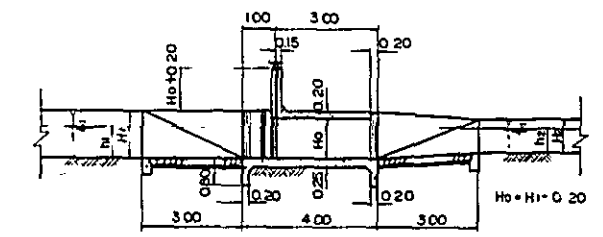

PROFILE

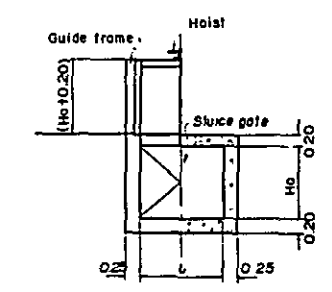

SECTION A-A

OVERSEAS TECHNICAL COOPERATION AGENCY TOKYO	
PHAN RANG AGRICULTURAL DEVELOPMENT PROJECT, VIET NAM	
TYPICAL CHECK GATE	
CONSULTING ENGINEERS NIPPON KOGI CO. LTD TOKYO	
DRAWN <i>S. Maeda</i>	DATE MAR. 10, 1972
CHECKED <i>K. Maeda</i>	
SUBMITTED <i>R. Yoshida</i>	
APPROVED	II-16

CHECK GATE

TYPE-D

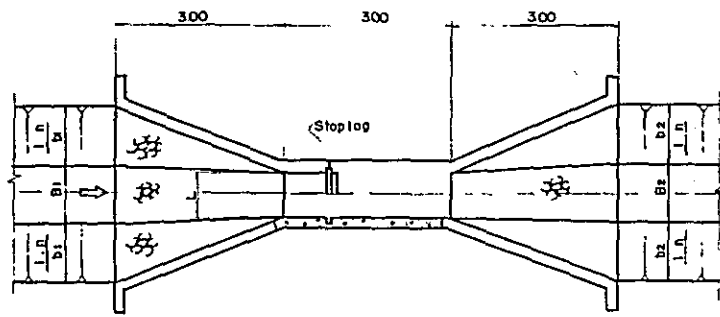

PLAN

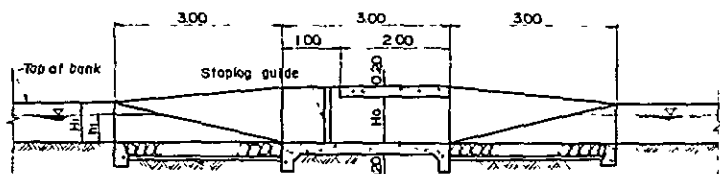

PROFILE

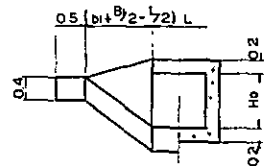
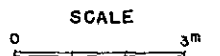

SECTION A-A

NOTE
TYPE - D CHECK GATE
Used at points where the canal
section is TYPE-J, TYPE-K &
TYPE - L

TYPE - A

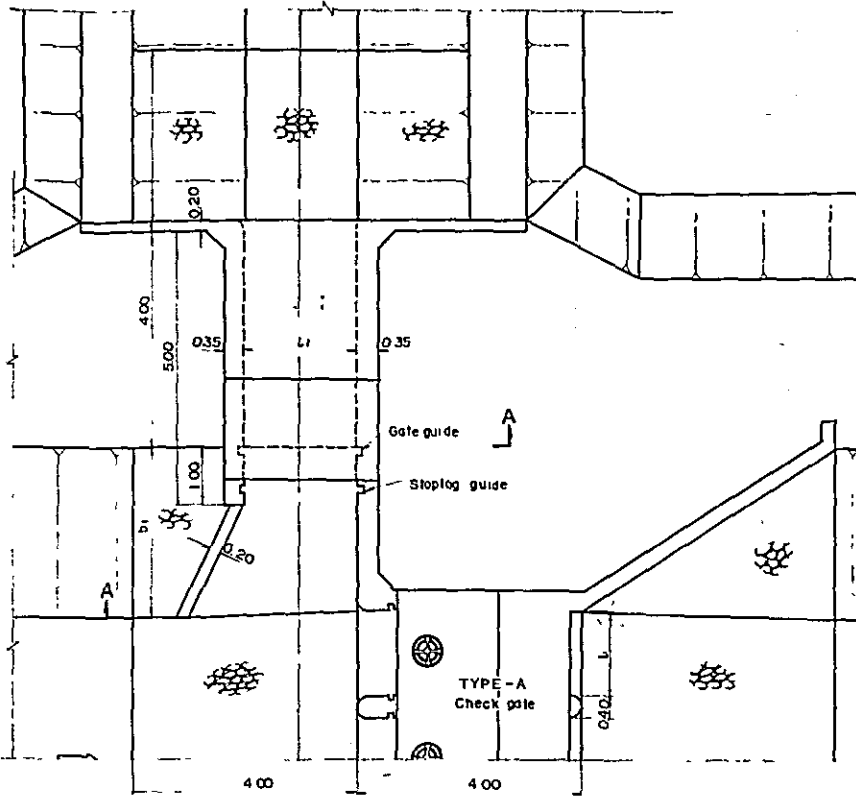

PLAN

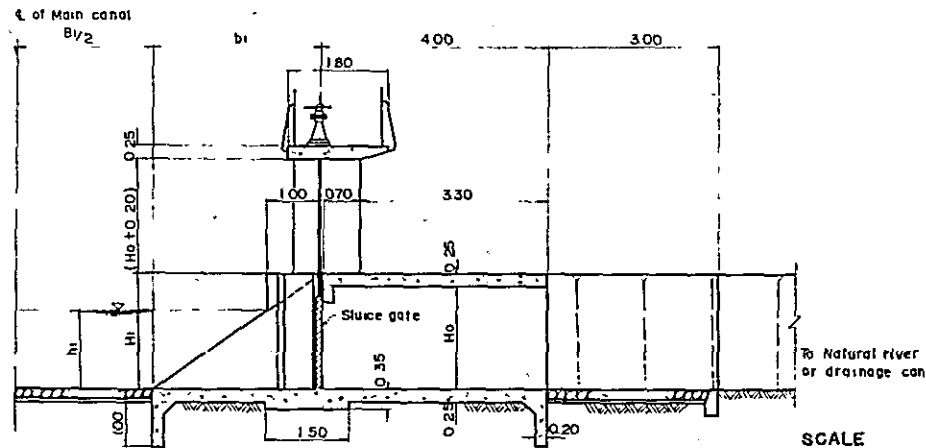

PROFILE

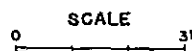

SPILLWAY

TYPE - B

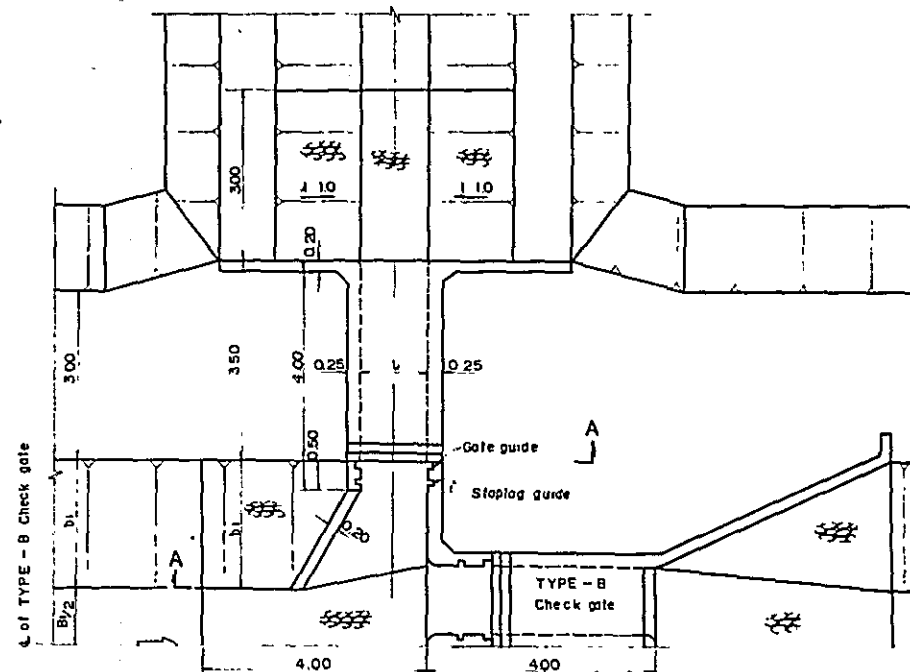

PLAN

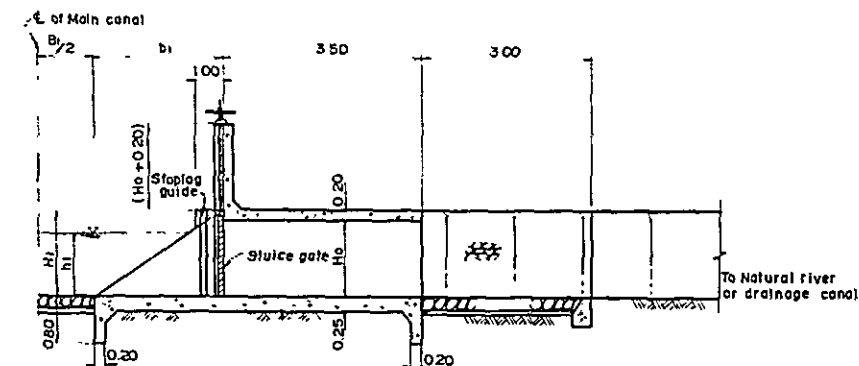

PROFILE

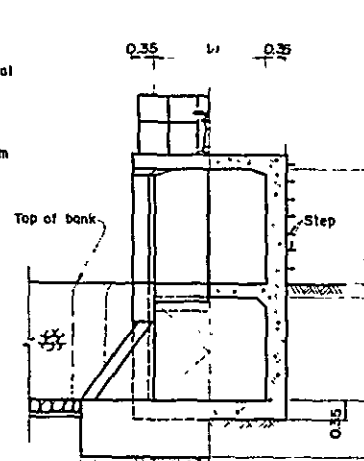
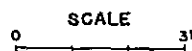

SECTION A-A

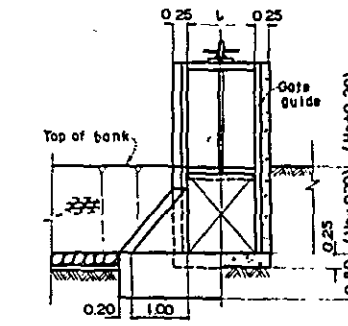

SECTION A-A

REFERENCE DRAWING
CANAL SECTION & DIMENSION --- DRW NO. II-4 to II-9
TYPE OF CHECK GATE --- DRW NO. II-16

OVERSEAS TECHNICAL COOPERATION AGENCY TOKYO	
PHAN RANG AGRICULTURAL DEVELOPMENT PROJECT, VIET NAM	
TYPICAL CHECK GATE AND SPILLWAY	
CONSULTING ENGINEERS NIPPON KOEI CO., LTD. TOKYO	
DRAWN CHECKED <i>K. Mada</i>	DATE: MAR. 10, 1972
SUBMITTED <i>R. Yoshida</i>	APPROVED
II-17	

NOTE
TYPE - A Used at points where the canal section is TYPE - A, TYPE - D & TYPE - E, joined with TYPE - A check gate
TYPE - B Used at points where the canal section is TYPE - B & TYPE - F, joined with TYPE - B check gate
TYPE - C Used at points where the canal section is TYPE - C, TYPE - G, TYPE - H & TYPE - I, joined with TYPE - C check gate
TYPE - D Used at points where the canal section is TYPE - J, TYPE - K, & TYPE - L, joined with TYPE - D check gate

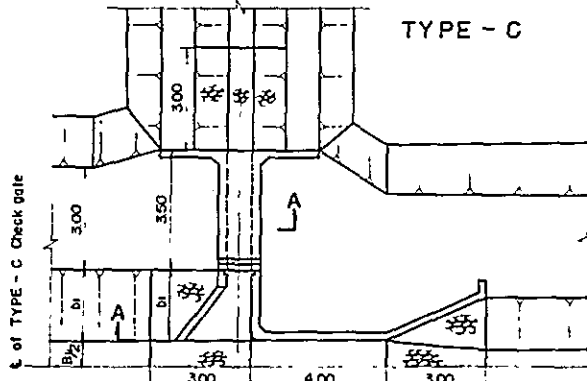

TYPE - C

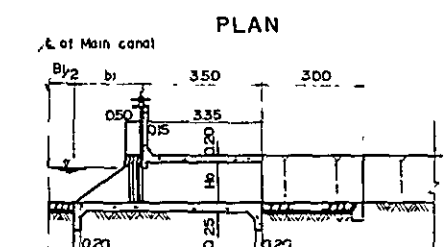

PROFILE

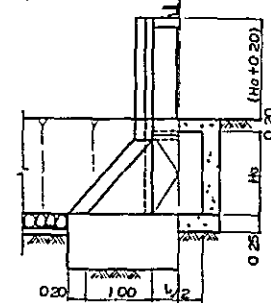
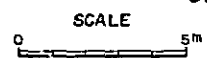

SECTION A-A

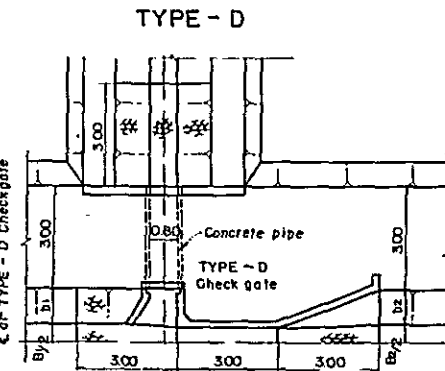

TYPE - D

PLAN

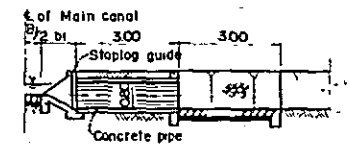

PROFILE

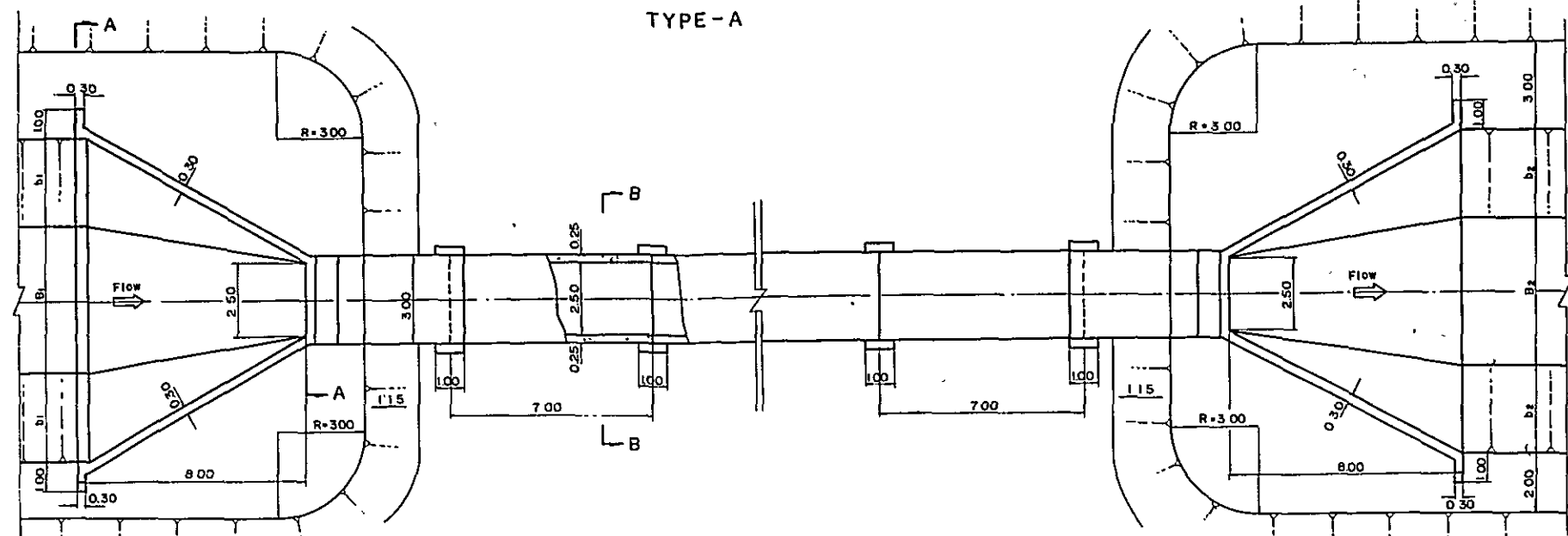

TYPE-A

PLAN

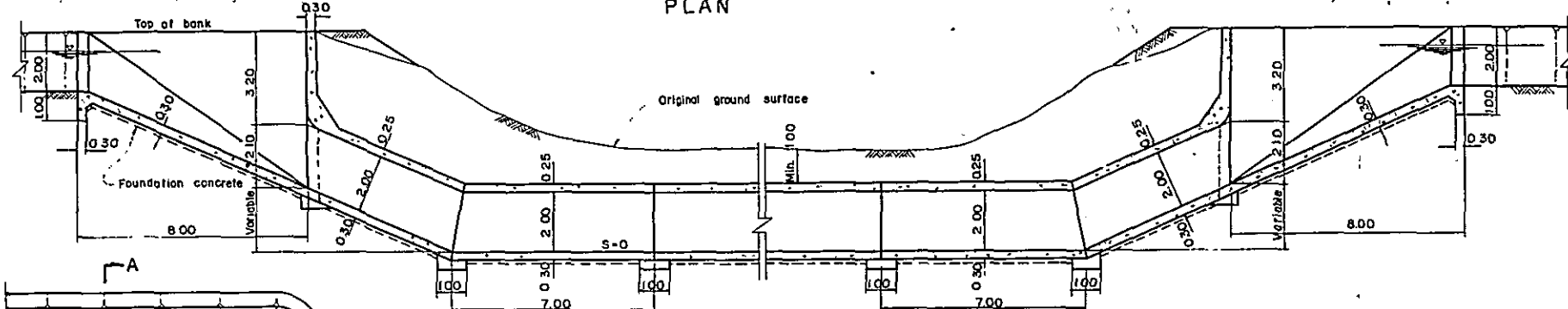

PROFILE
TYPE-B, C & D

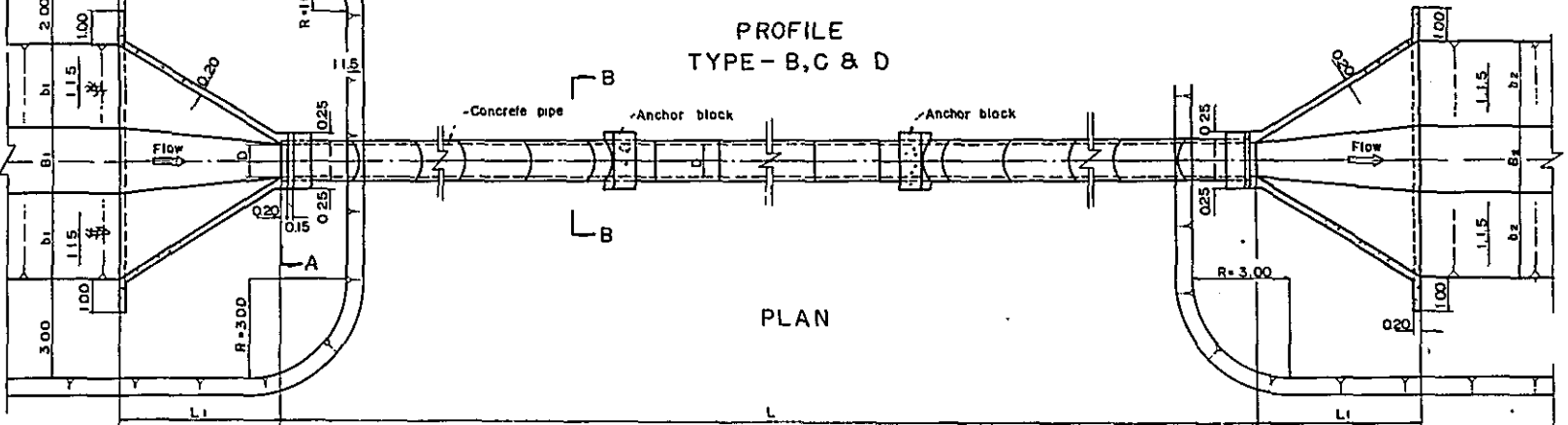

PLAN

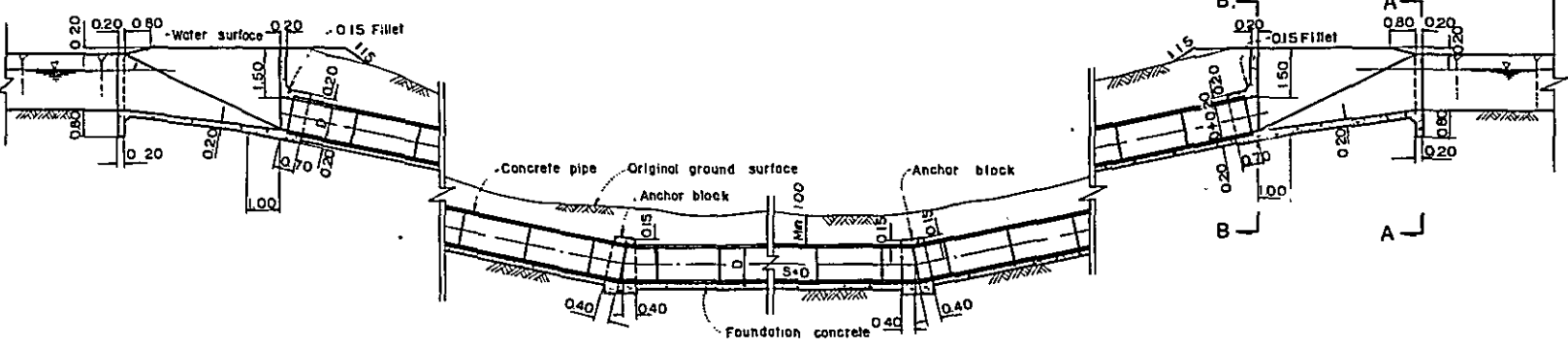

PROFILE

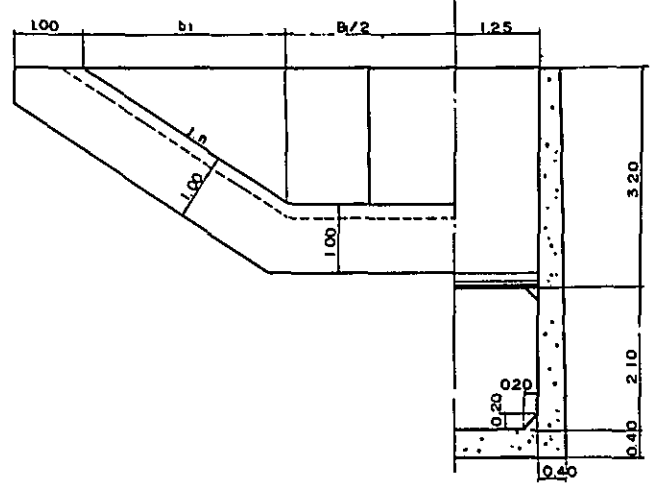
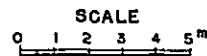

SECTION A-A

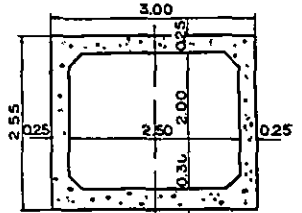

SECTION B-B

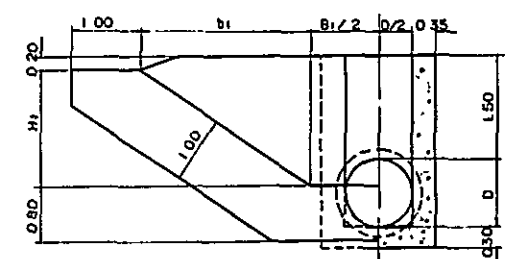

SECTION A-A

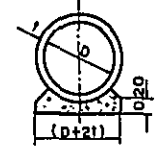

SECTION B-B

NOTE

- TYPE-A Used at points where the Canal Section is TYPE-D & TYPE-E
- TYPE-B Used at points where the Canal Section is TYPE-C & TYPE-G
- TYPE-C Used at points where the Canal Section is TYPE-J & TYPE-I
- TYPE-D Used at points where the Canal Section is TYPE-K

REFERENCE DRAWING
CANAL SECTION & DIMENSION - DWG NO. II-4 to II-9

BARREL LENGTH --- DWG NO II-4 to II-9

OVERSEAS TECHNICAL COOPERATION AGENCY TOKYO	
PHAN RANG AGRICULTURAL DEVELOPMENT PROJECT, VIET NAM	
TYPICAL SIPHON	
CONSULTING ENGINEERS NIPPON KOEI CO., LTD. TOKYO	
DRAWN <i>K. Maeda</i>	DATE MAR. 19, 1972
CHECKED <i>K. Maeda</i>	
SUBMITTED <i>R. Yoshida</i>	
APPROVED	II-18

CULVERT
TYPE - A, B & C

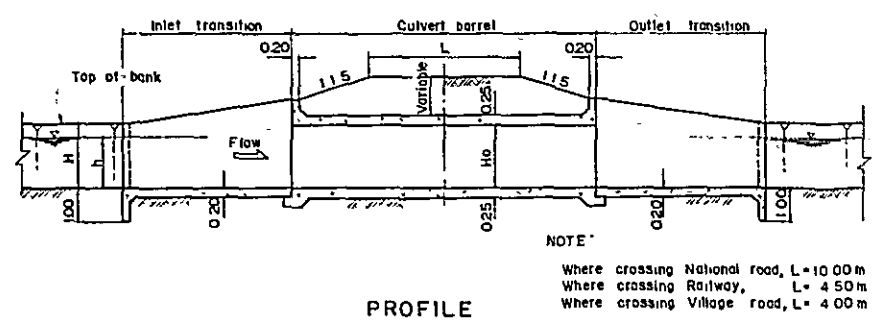

PROFILE

NOTE
Where crossing National road, L = 10.00 m
Where crossing Railway, L = 4.50 m
Where crossing Village road, L = 4.00 m

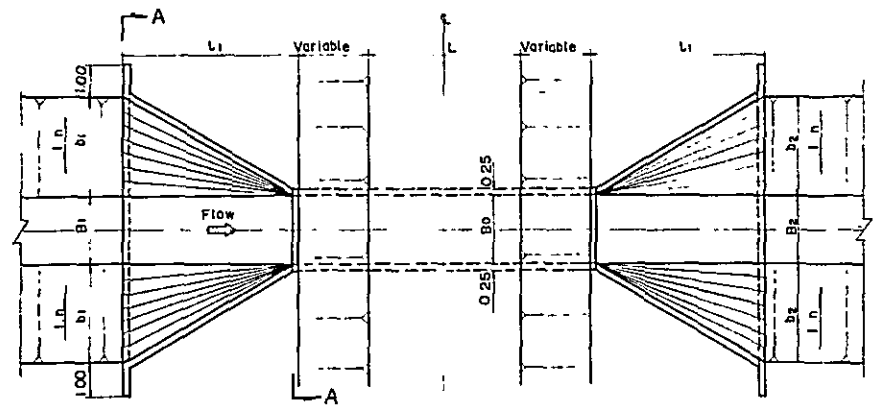

PLAN

TYPE - D, E & F

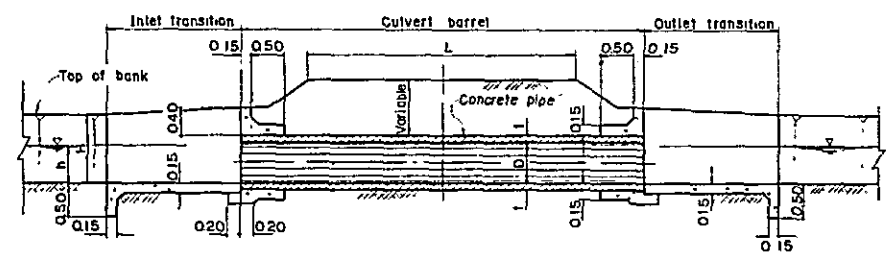
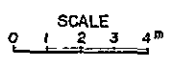

PROFILE

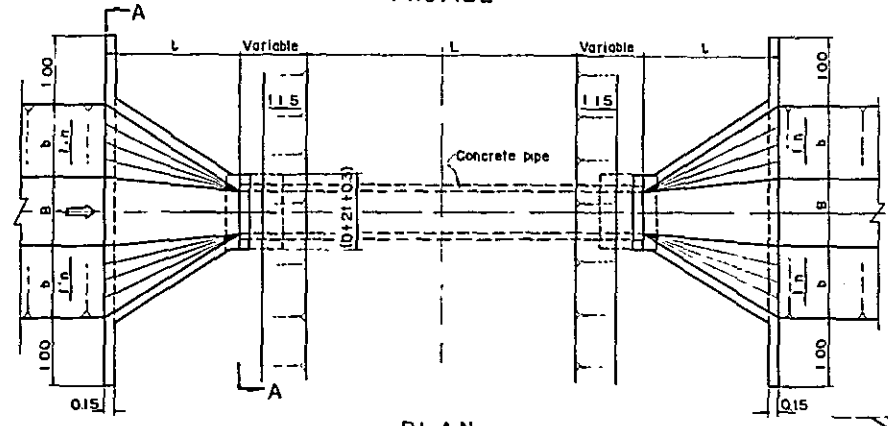

PLAN

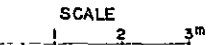

NOTE
Where crossing National road, L = 10.00 m
Where crossing Railway, L = 4.50 m
Where crossing Village road, L = 4.00 m

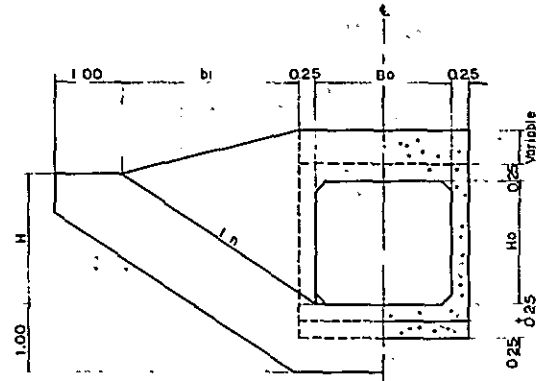

SECTION A - A

TYPE OF CULVERT	Bo	Ho	Li	CANAL SECTION
TYPE - A	1.50	1.00	7.00	TYPE-F&G
TYPE - B	1.00	1.00	5.00	TYPE-H
TYPE - C	0.80	0.80	4.50	TYPE-I

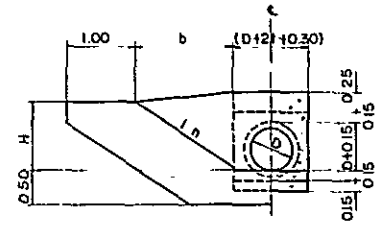

SECTION A - A

TYPE OF CULVERT	D	Li	CANAL SECTION
TYPE - D	φ1.00	3.00	TYPE - C
TYPE - E	φ0.60	3.00	TYPE - J
TYPE - F	φ0.40	2.50	TYPE - K

TYPICAL SECTION OF MAIN FARM ROAD

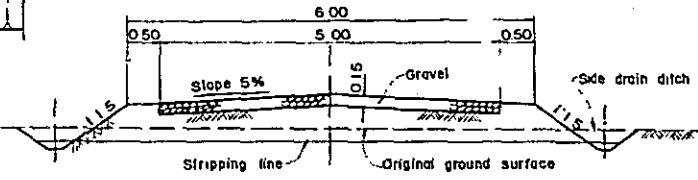

BRIDGE

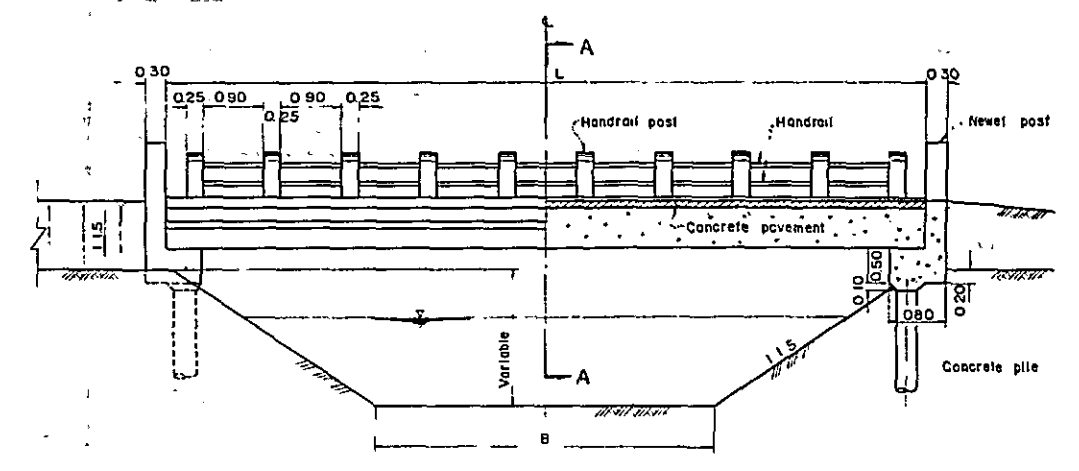

PROFILE

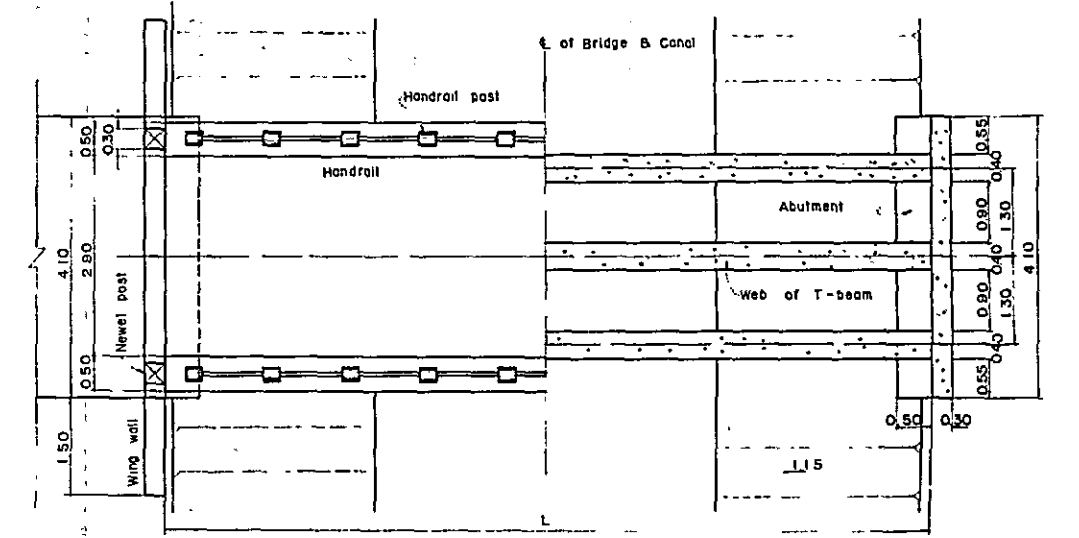

PLAN

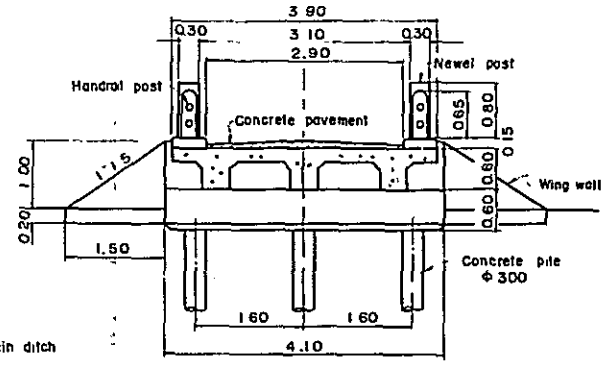
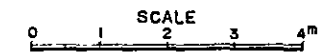

SECTION A - A

NOTE
TYPE - A Beam length L = 11.20 m
TYPE - B Beam length L = 10.00 m

NOTE REFERENCE DRAWINGS
CANAL SECTION & DIMENSION - DWG NO II-4 to II-9

OVERSEAS TECHNICAL COOPERATION AGENCY TOKYO	
PHAN RANG AGRICULTURAL DEVELOPMENT PROJECT, VIET NAM	
TYPICAL CULVERT, BRIDGE AND TYPICAL CROSS SECTION OF MAIN FARM ROAD	
CONSULTING ENGINEERS NIPPON KOEI CO., LTD. TOKYO	
DRAWN <i>T. Mada</i>	DATE MAR 10, 1972
CHECKED <i>K. Mada</i>	
SUBMITTED <i>R. Yoshida</i>	
APPROVED	II - 19

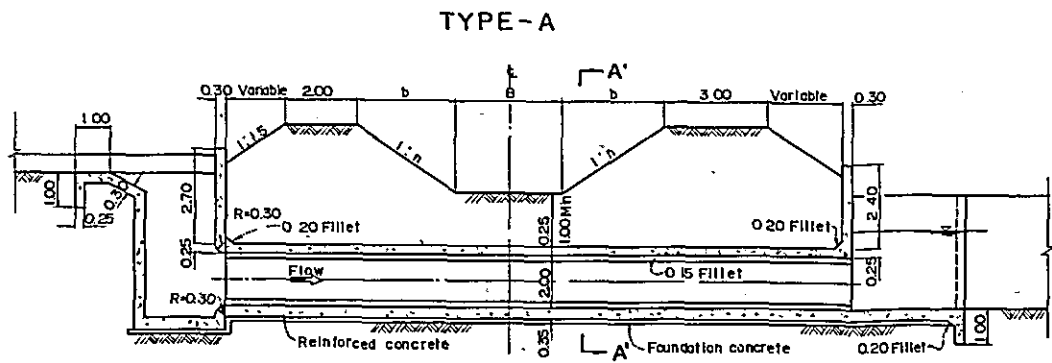

PROFILE

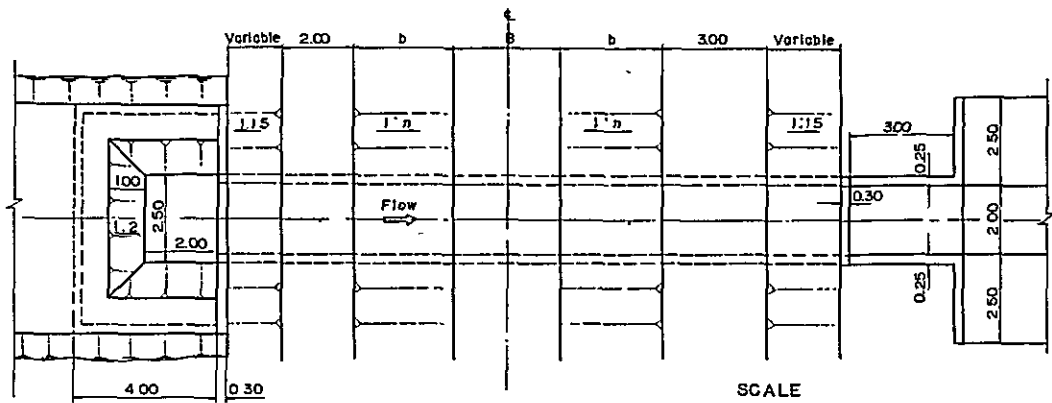

PLAN

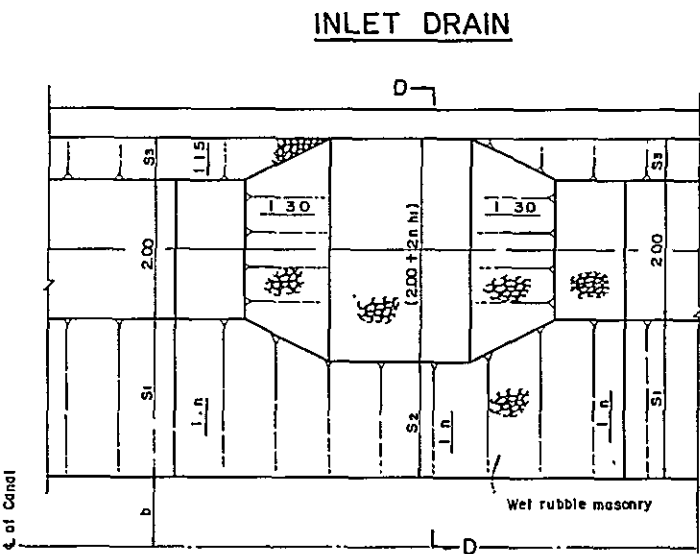

PLAN

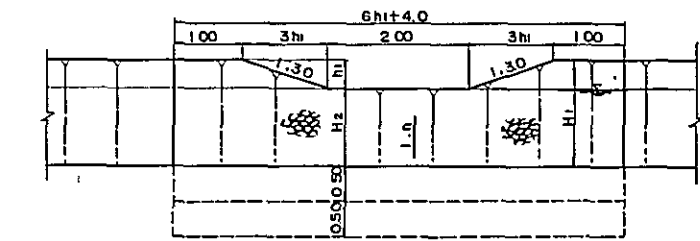

PROFILE

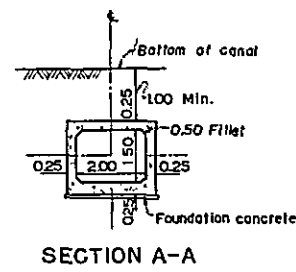

SECTION A-A

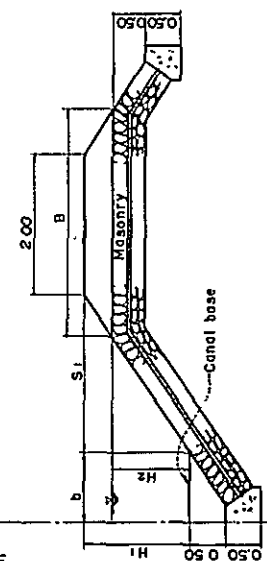

SCALE 0 1 2 3 4 5m

CROSS DRAIN

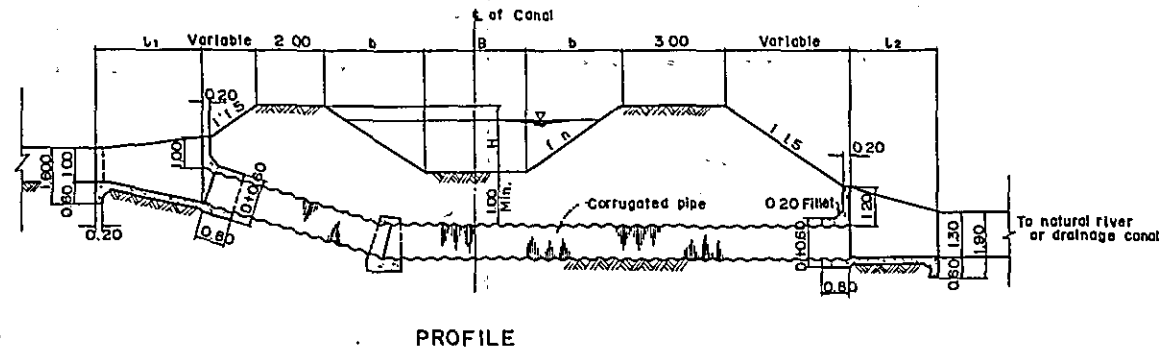

PROFILE

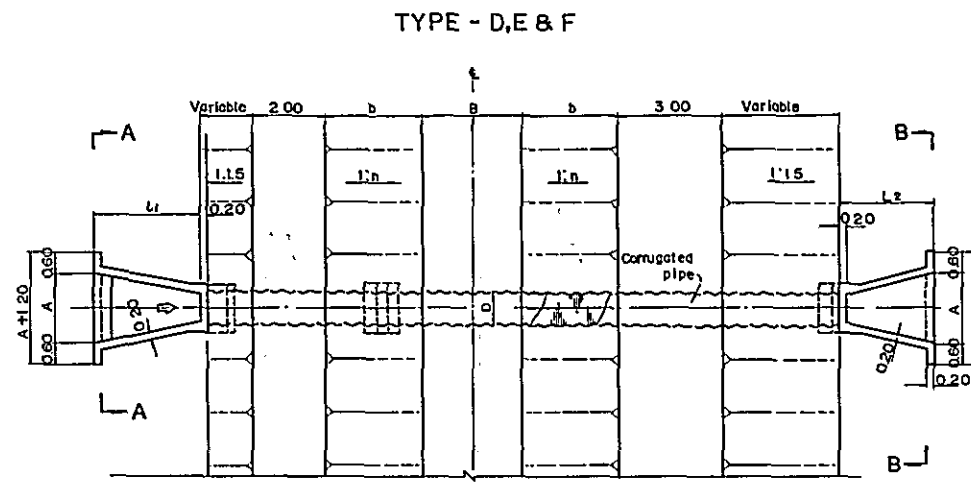

PLAN

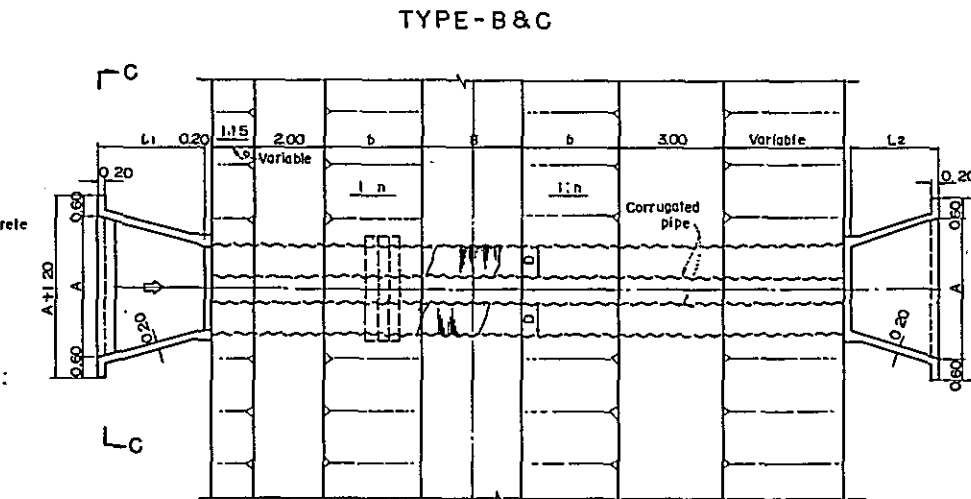

PLAN

NOTE.

- TYPE - A. Applied to the areas with more than 3.9 km² of drainage area
- TYPE - B: Applied to the areas with more than 2.3 km² of drainage area
Corrugated pipe barrel, ϕ 100, 2 nos.
- TYPE - C: Applied to the areas with more than 1.6 km² of drainage area
Corrugated pipe barrel, ϕ 80, 2 nos
- TYPE - D: Applied to the areas with more than 0.8 km² of drainage area
Corrugated pipe barrel, ϕ 100, 1 no.
- TYPE - E: Applied to the areas with more than 0.4 km² of drainage area
Corrugated pipe barrel, ϕ 80, 1 no.
- TYPE - F Applied to the areas with less than 0.4 km² of drainage area
Corrugated pipe barrel ϕ 60, 1 no.

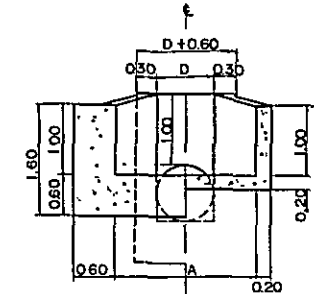

SECTION A-A

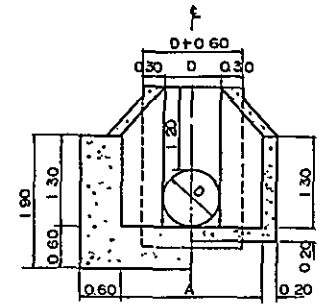

SECTION B-B

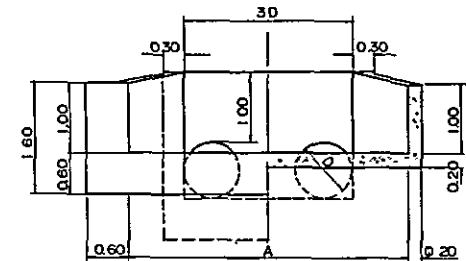

SECTION C-C

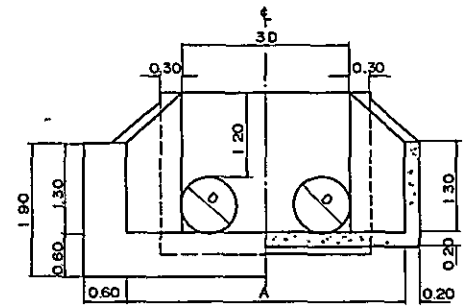

SECTION D-D

REFERENCE DRAWING
CANAL SECTION & DIMENSION — DRW NO II-4 to II-9

OVERSEAS TECHNICAL COOPERATION AGENCY TOKYO	
PHAN RANG AGRICULTURAL DEVELOPMENT PROJECT, VIET NAM	
TYPICAL CROSS DRAIN AND INLET DRAIN	
CONSULTING ENGINEERS NIPPON KOEI CO., LTD TOKYO	
DRAWN <i>K. Maeda</i>	DATE MAR. 10, 1972
CHECKED <i>R. Yoshida</i>	II-20
SUBMITTED <i>R. Yoshida</i>	
APPROVED	

TYPE - C, D, E & F

SIDE SPILLWAY

TYPE - A & B

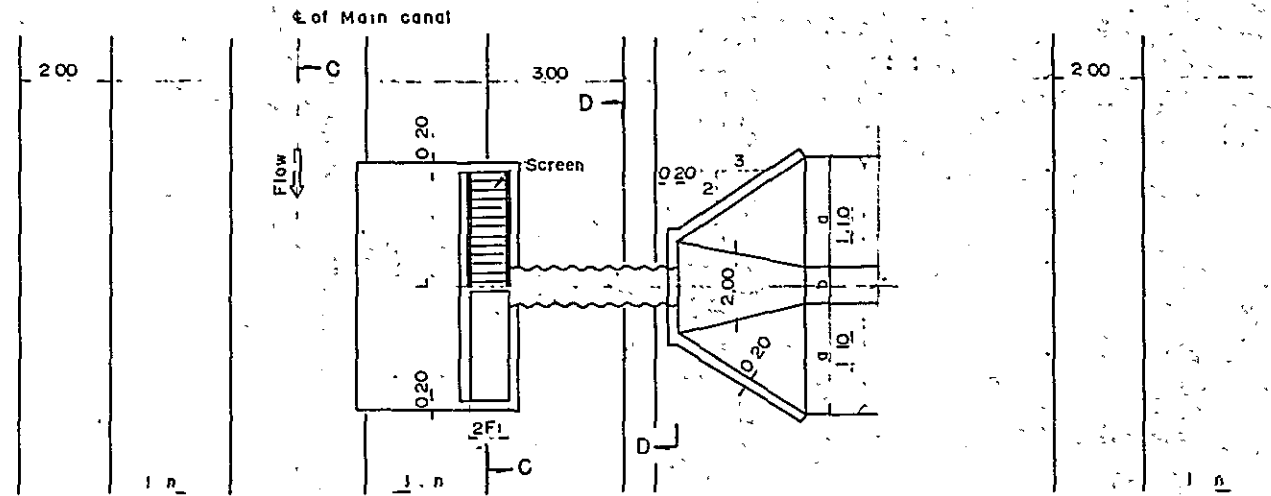

PROFILE

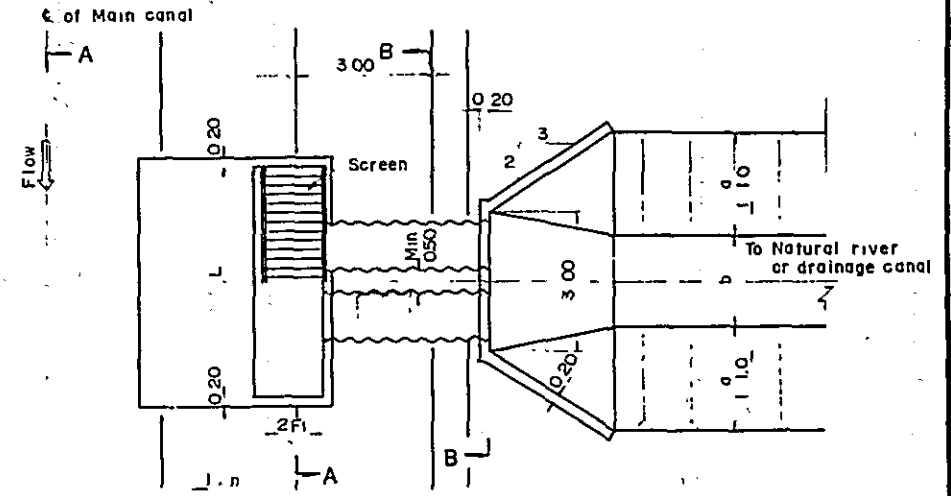

PROFILE

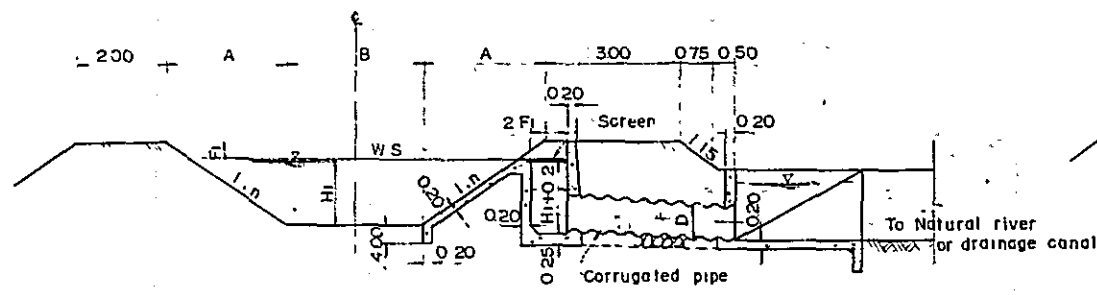

PLAN

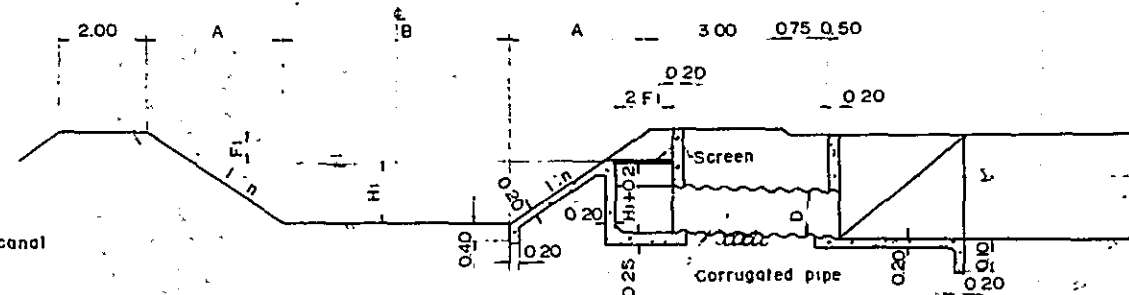
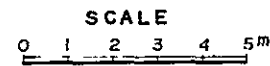

PLAN

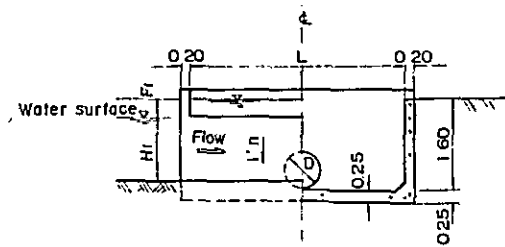
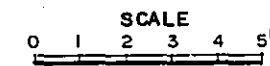

SECTION C-C

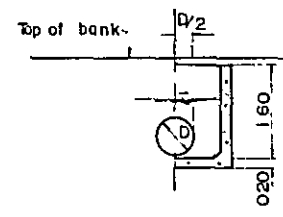

SECTION D-D

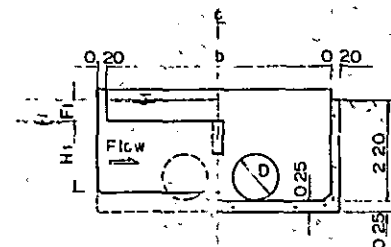

SECTION A-A

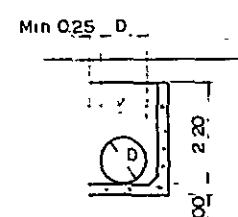

SECTION B-B

TYPE	L	φ	nos	CANAL SECTION
TYPE - A	7.00	φ1,000	2	TYPE - A
TYPE - B	5.00	φ1,000	2	TYPE - D & E
TYPE - C	3.50	φ1,000	1	TYPE - B
TYPE - D	2.50	φ 800	1	TYPE - F
TYPE - E	1.50	φ 600	1	TYPE - C, G, H & I
TYPE - F	0.90	φ 400	1	TYPE - J, K & L

OVERSEAS TECHNICAL COOPERATION AGENCY
TOKYO

PHAN RANG AGRICULTURAL DEVELOPMENT PROJECT, VIET NAM

TYPICAL SIDE SPILLWAY

CONSULTING ENGINEERS
NIPPON KOEI CO., LTD. TOKYO

DRAWN: *K. Maeda*
CHECKED: *K. Maeda*
SUBMITTED: *K. Maeda*
APPROVED: *K. Maeda*

DATE: MAR. 10, 1972

II - 21

IRRIGATION BLOCK

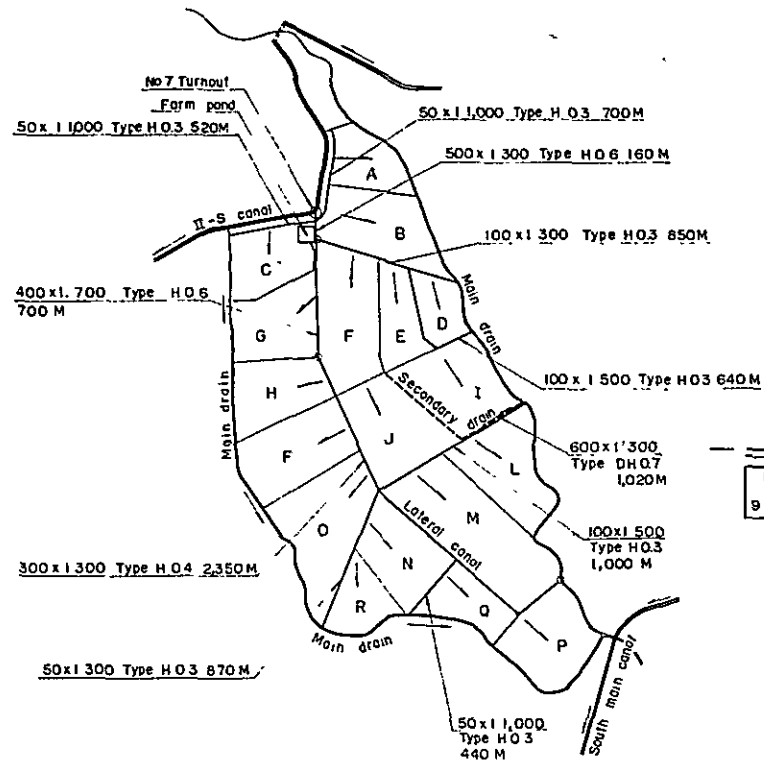

IRRIGATION SYSTEM

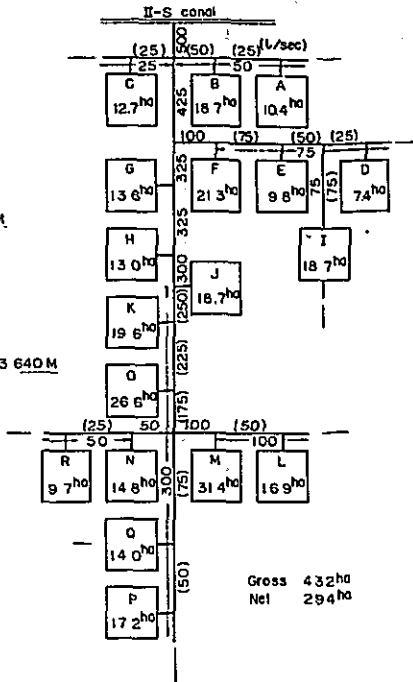

TYPE OF LATERAL CANAL

Q	S	1/300	1/500	1/700	1/1,000
500	H 0 6	H 0 7			
400	H 0 6				
300					
200	H 0 4				
100					
50	H 0 3				

STOPLOG FOR LATERAL



STOPLOG FOR LATERAL BRANCH

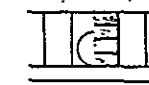

CHECK & CULVERT

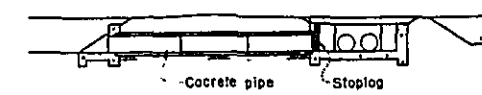
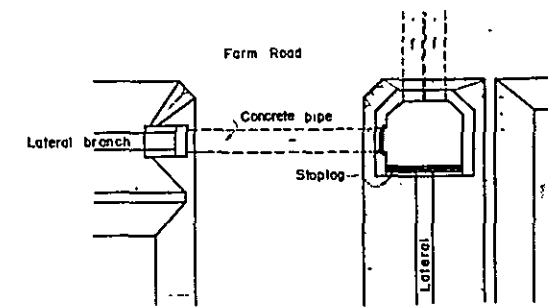

SCALE 0 5m

FIELD LAYOUT FOR STANDARD FARM

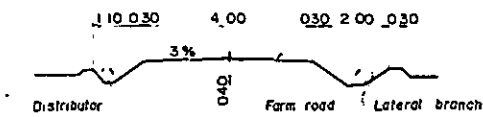
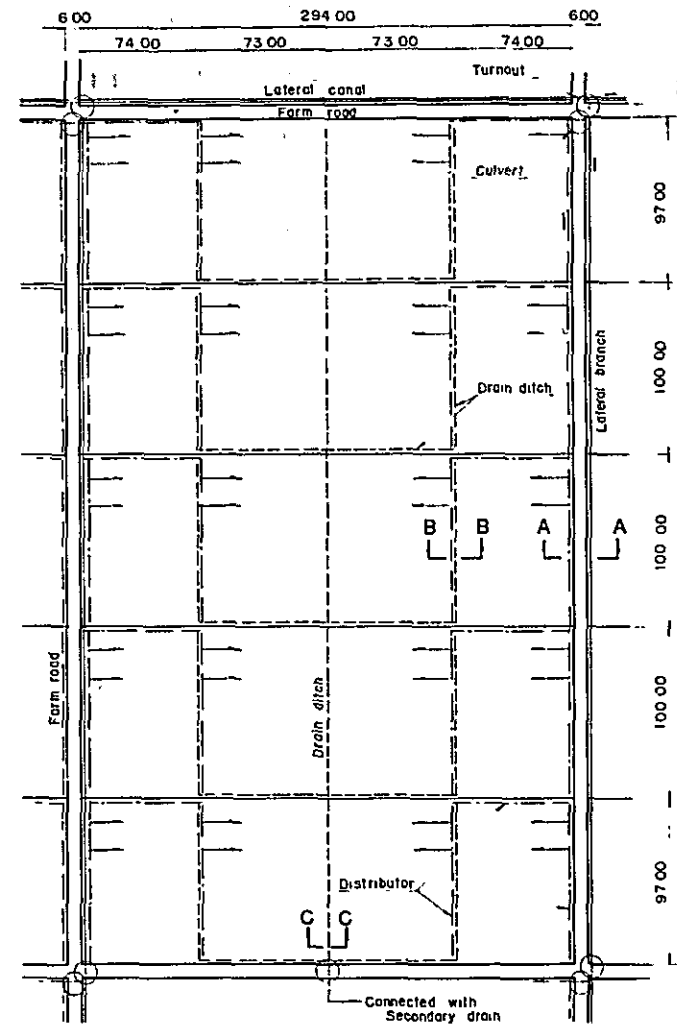

SECTION A-A

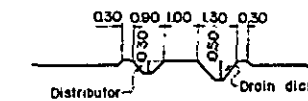

LEGEND

- Farm road
- Lateral canal
- Lateral branch
- Distributor
- Drain ditch
- Check & culvert

SCALE 0 5m

SECONDARY DRAIN

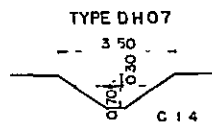

LATERAL CANAL

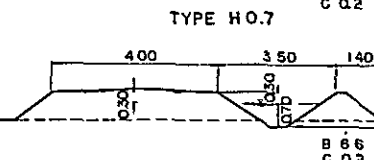
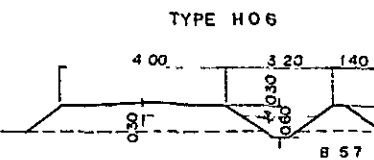
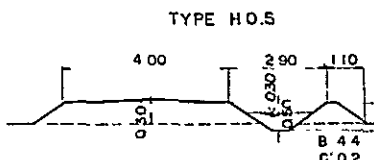
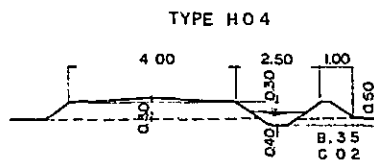
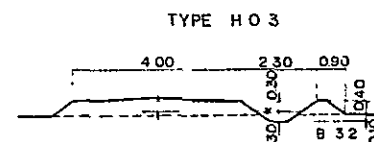

FARM POND

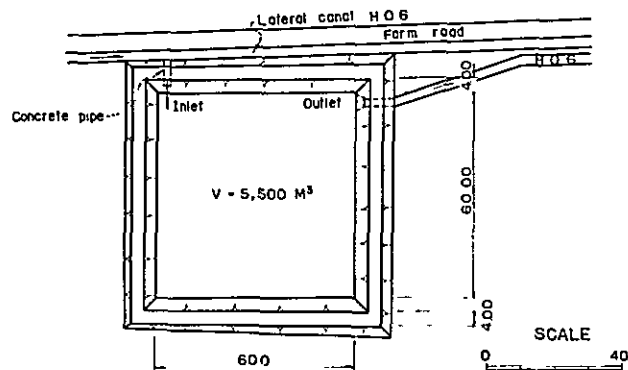

OUTLET

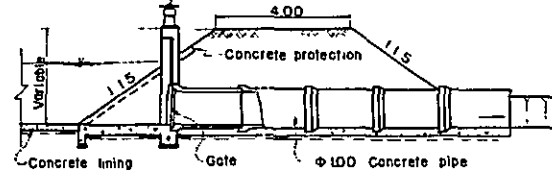

SCALE 0 5m

DRAIN DITCH

(Covered with grass)

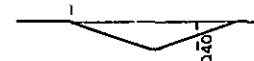

SECTION C-C

SCALE 0 1 2m

OVERSEAS TECHNICAL COOPERATION AGENCY
 TOKYO
 PHAN RANG AGRICULTURAL DEVELOPMENT PROJECT, VIET NAM
TYPICAL FIELD LAYOUT
 CONSULTING ENGINEERS
 NIPPON KOEI CO. LTD. TOKYO
 DRAWN: *[Signature]*
 CHECKED: *K. Maeda*
 SUBMITTED: *[Signature]*
 APPROVED: *[Signature]*
 DATE: MAR 10, 1972
 II-22

