



PL 1-9-41

GEOLOGICAL SURVEY OF
MONYWA AREA UNION OF BURMA
(PHASE II)

CORE LOG and ASSAY

D.D.H. No. 32 E Sheet I
Total Length 424.0 feet Core Recovery
Location Subedang Elevation 99.2 m
Direction 0 Inclination -9°
Date of Logging from 8-8-66 to 14-9-66
Logged by S. MONONOBE

METAL MINING AGENCY
OVERSEAS TECHNICAL COOPERATION AGENCY
GOVERNMENT OF JAPAN
SEPTEMBER 1974
Prepared by INTSU KINZOU ENGINEERING SERVICE CO. LTD.

Depth (m) (feet)	Core Section	Particulars	Alteration & Mineralization		Result of Chemical Analysis						
			arg.	sil.	py.	cu.	Sample No.	Core Length	T-Cu %		
0.0		top core									
10.0	Δ	tuffaceous rock subangular fragment of quartz - feldspar (5-5 mm)									
20.0	Δ	biotite porphyry (lava)									
30.0	Δ	biotite : 3-5 mm feldspar : 4-6 mm									
40.0	Δ	biotite porphyry quartz phenocryst, feldspar phenocryst rich rock									
50.0	Δ	chalcocite-quartz vein pyrite pyrite silicified biotite porphyry orthoclase-sericite with rock fragment biotite porphyry rhyolite tuff mixture									
60.0	Δ	chalcocite veinlet chalcocite veinlet rhyolite tuff fragment tuffaceous rock fine grained quartz fragment pyrite vein biotite, brown colored (3-4 mm) porphyry with tuffaceous breccia									
70.0	Δ	pyrite pebbled fragment brecciated biotite porphyry with fine grained igneous rock or tuff porphyritic rock fragments biotite veinlet veinlet to vein matrix - siliceous some large fragments									
80.0	Δ	lapilli tuff									
90.0	Δ	fine grained sand									
100.0	Δ	tuffaceous rock siliceous fragment (5-10 mm) rhyolite tuff breccia pyrite vein									
110.0	Δ	tuffaceous rock siliceous fragment 20x20 mm ... 5x 5 mm ...									
120.0	Δ	unrounded fragment some large silica fragments (pyroclastic flow)									
130.0	Δ	bottom									

LEGEND

- Mudstone
- Sandstone
- Lapilli tuff
- Rhyolite
- Porphyry
- Brecciation
- Inclination of plane structures
- (bedding plane intrusive boundary etc)

DEGREE OF ALTERATION AND MINERALIZATION

argillization	silicification	pyritization	mineralization
fresh	SiO ₂ < 55 %	FeS ₂ < 1 %	Cu < 0.2 %
weak	55 ~ 65 %	1 ~ 5 %	0.3 ~ 0.5 %
medium	65 ~ 80 %	5 ~ 10 %	0.6 ~ 0.9 %
strong	> 80 %	> 10 %	> 1 %

* fresh : unaltered
weak : parts of feldspar phenocrysts changed
medium : almost all the feldspar phenocrysts changed into clay minerals
strong : not only feldspar phenocrysts but also ground mass changed into clay minerals (by field observation)

ABBREVIATIONS

- arg. : Argillization
- sil. : Silicification
- py. : Pyritization
- kaol. : Kaolinization
- ser. : Sericitization
- ch. : Chloritization
- alu. : Alunification
- c.c.p. : Chalcopyrite
- c.c. : Chalcocite
- en. : Enargite
- dis. : Dissemination
- v. : Veinlet
- w. : Width

国際協力事業団
08816
図書資料課蔵書

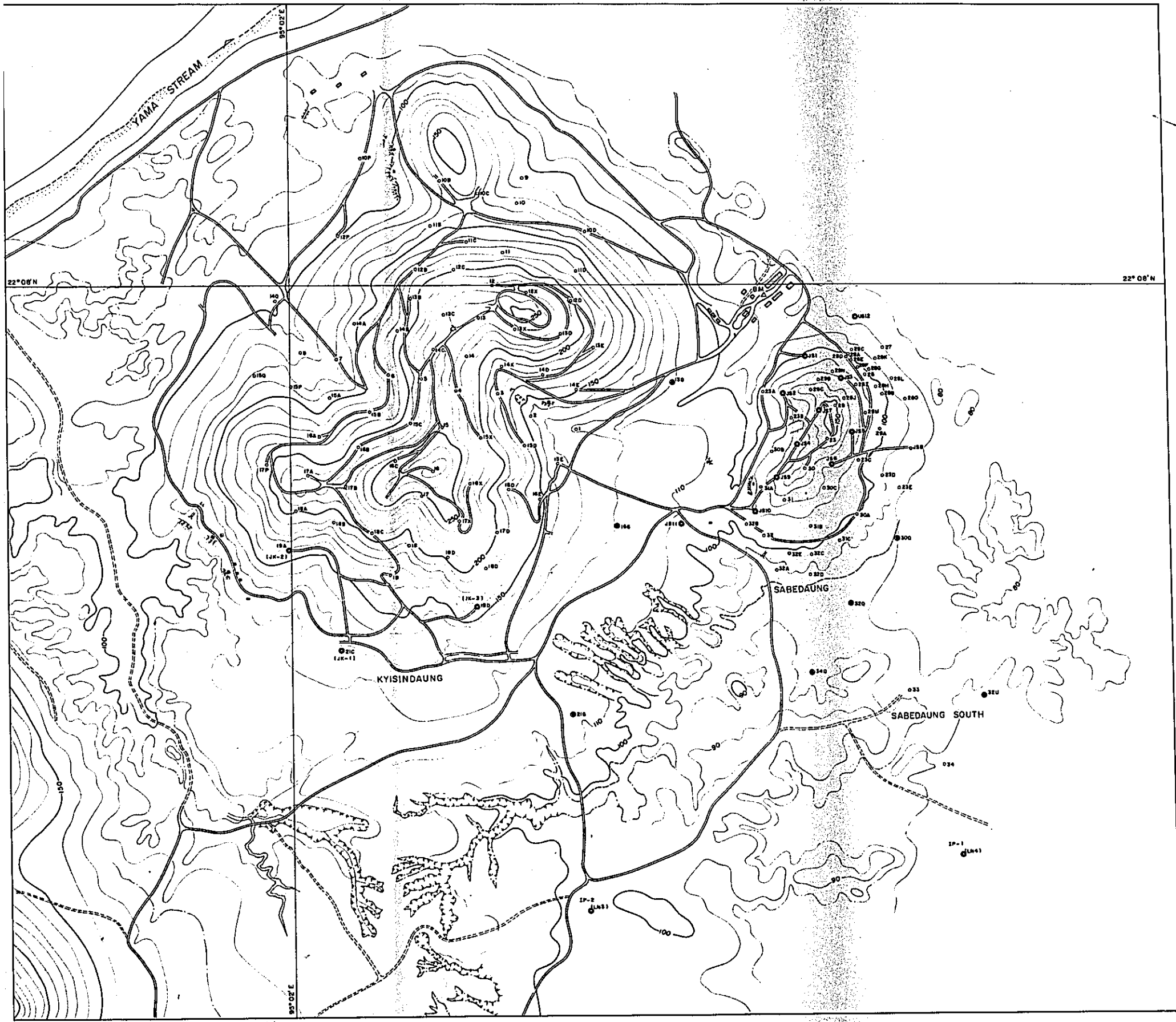

PL. I-10

GEOLOGICAL SURVEY OF
MONYWA AREA, UNION OF BURMA
(PHASE II)

LOCALITY MAP OF DRILL HOLES
IN KYISINDAUNG AND SABEDAUNG SECTOR

Scale 1:5,000

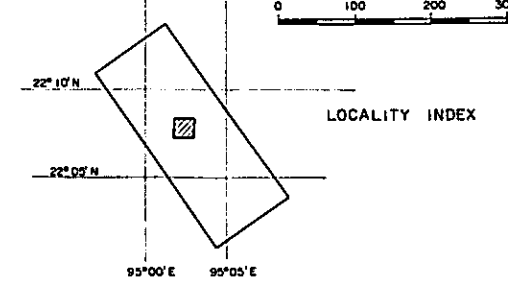

METAL MINING AGENCY
OVERSEAS TECHNICAL COOPERATION AGENCY
GOVERNMENT OF JAPAN

SEPTEMBER 1974

Prepared by MITSUI KINZOKU ENGINEERING SERVICE CO., LTD.

LEGEND

- JS8 Drill Hole by Japanese Survey Team
(● 1972, PHASE I ● 1973, PHASE II)
- 16D Drill Hole by M.M.D.C.
- Jeepable Road
- 100 Contours (Interval 10^m)
- Old Working

GEOLOGICAL SURVEY OF
MOHYWA AREA, UNION OF BURMA
(PHASE II)

LOCALITY MAP OF DRILL HOLES
IN LETPADAUNG SECTOR

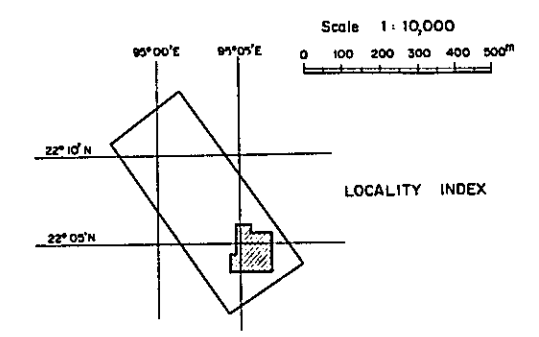

METAL MINING AGENCY
OVERSEAS TECHNICAL COOPERATION AGENCY
GOVERNMENT OF JAPAN
SEPTEMBER 1974
Prepared by MITSUI KINZOKU ENGINEERING SERVICE CO., LTD.

LEGEND

- Drill Hole by M.R.D.C
- Jeepable Road
- Contours (Interval 10m)
- Old Working

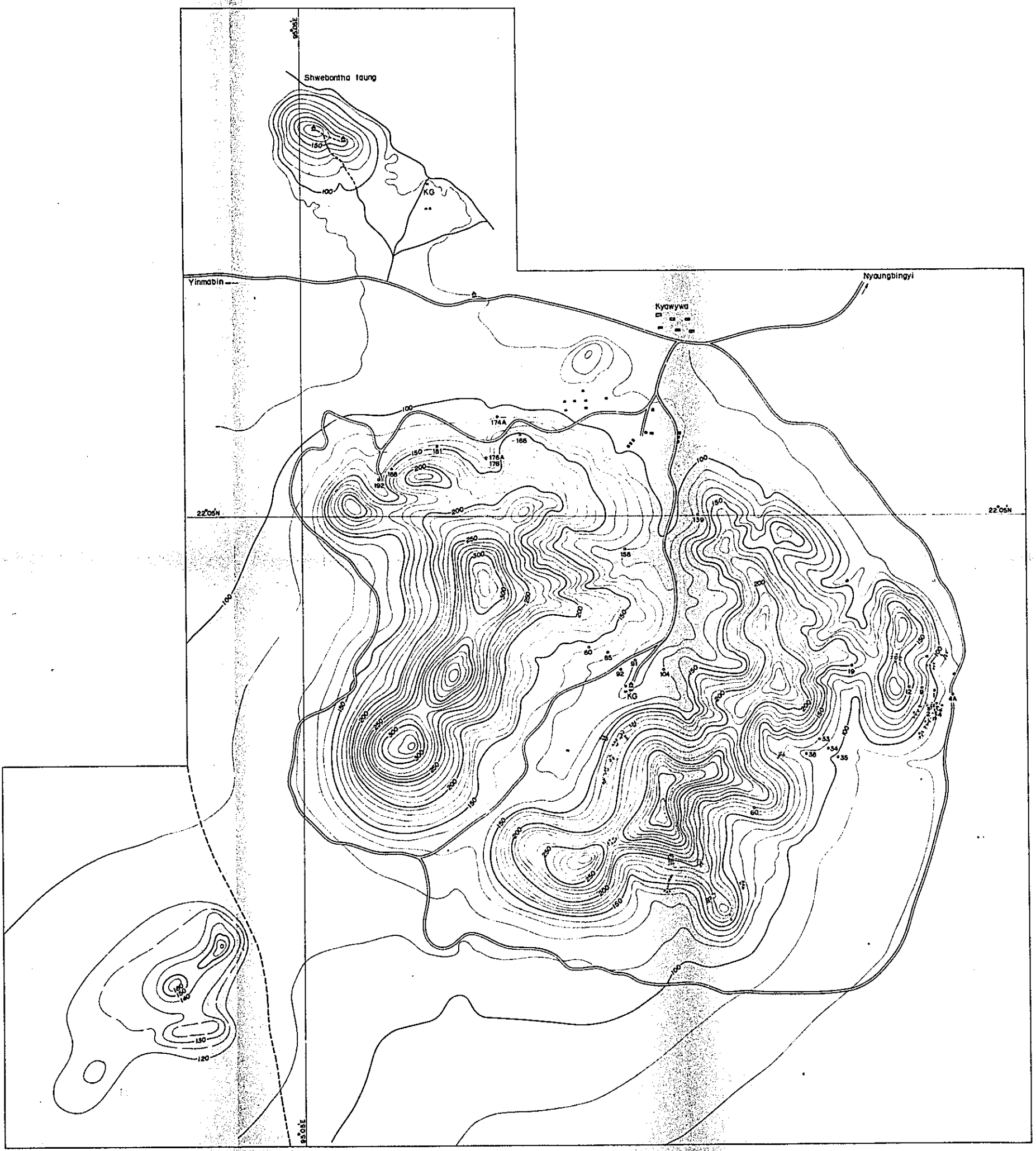

9 - 9

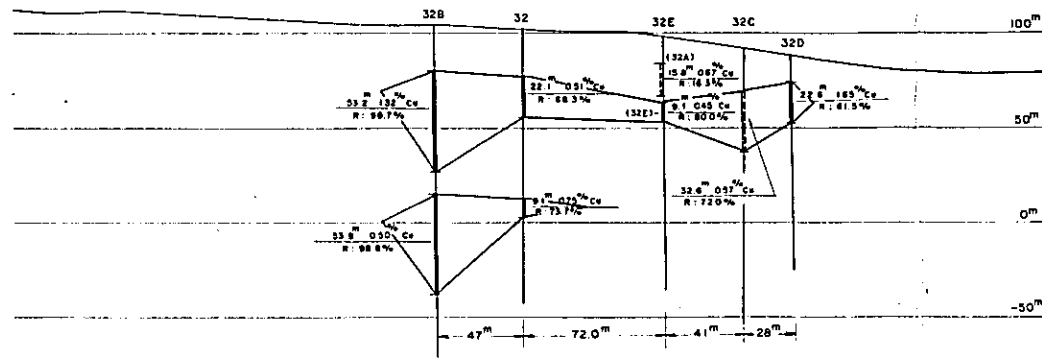

10 - 10

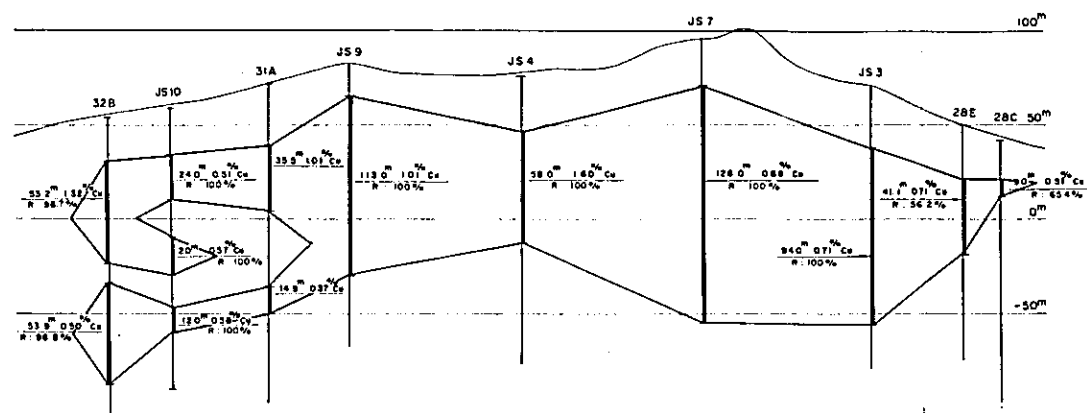

11 - 11

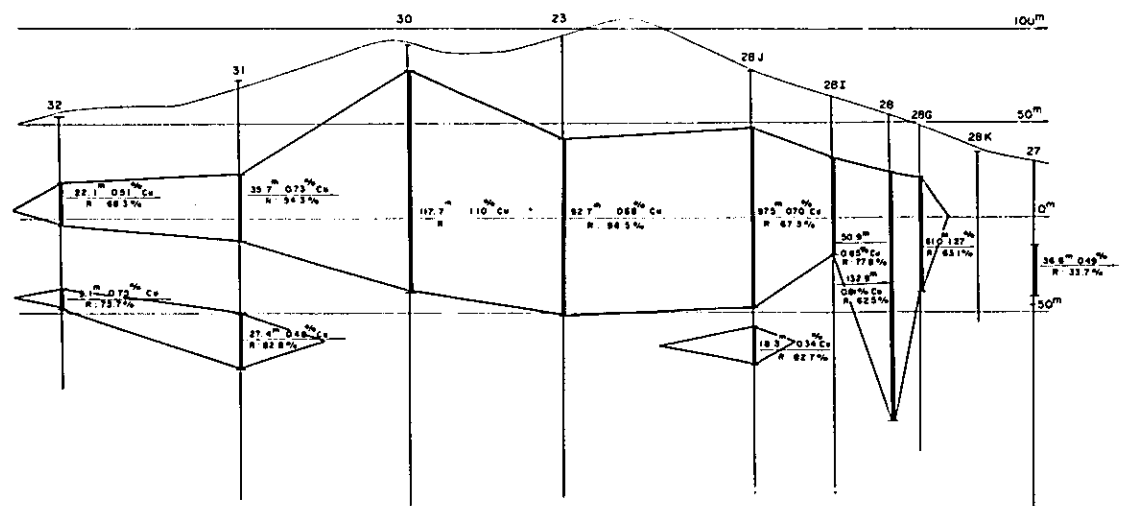

12 - 12

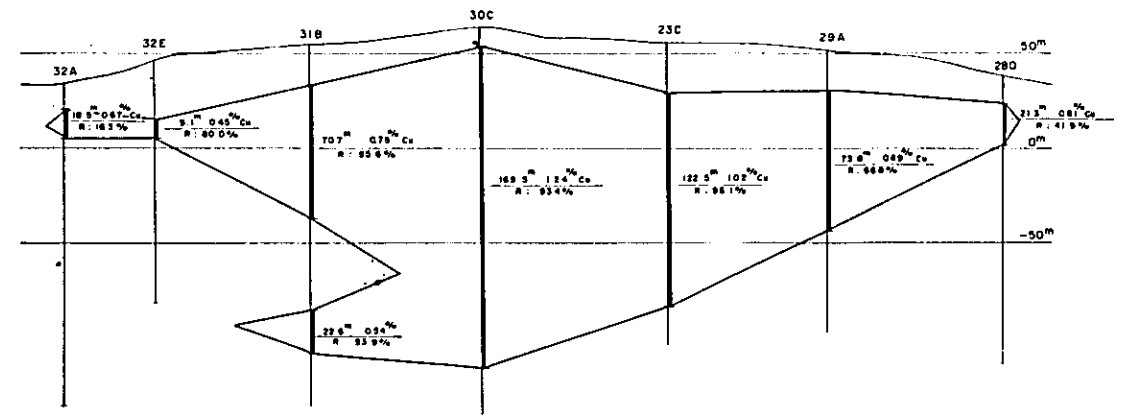

6 - 6

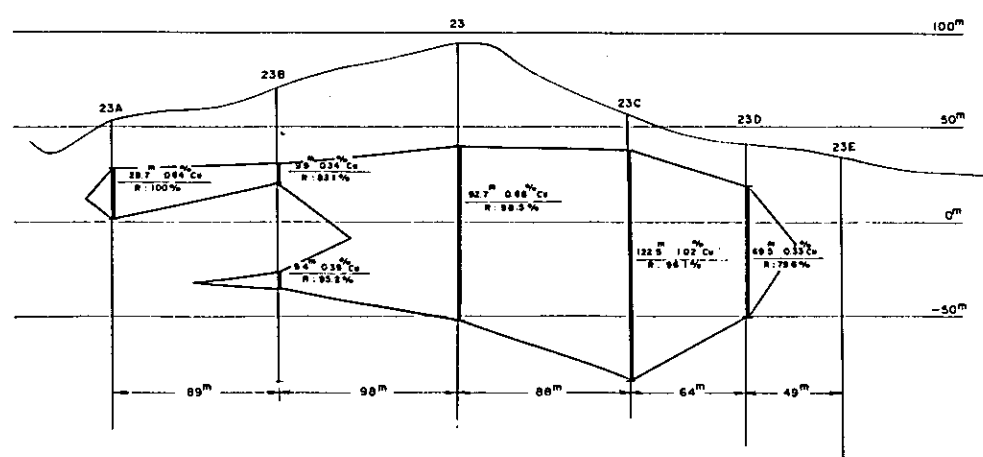

6(1) - 6(1)

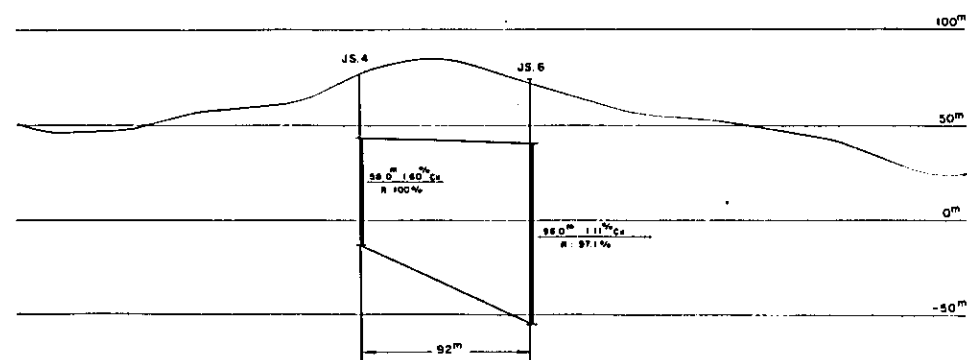

7 - 7

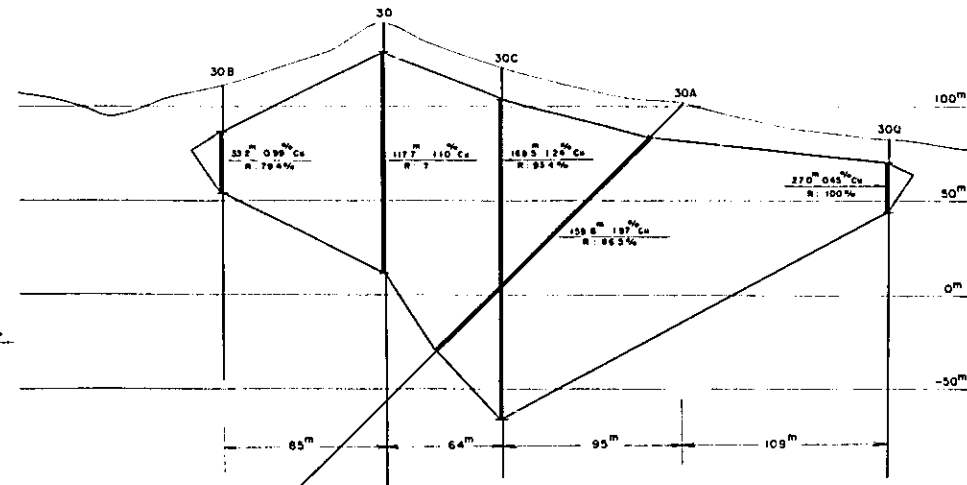

8 - 8

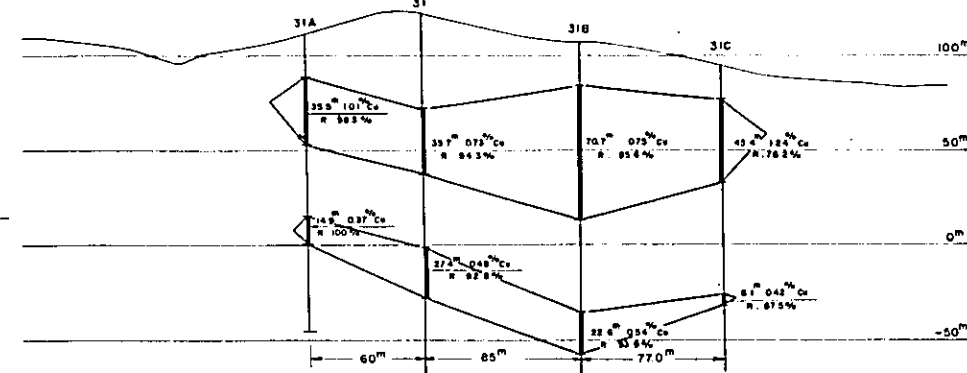

3 - 3

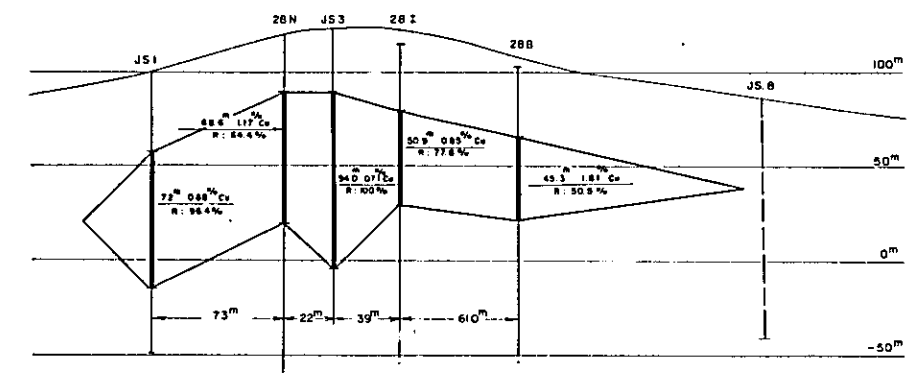

4 - 4

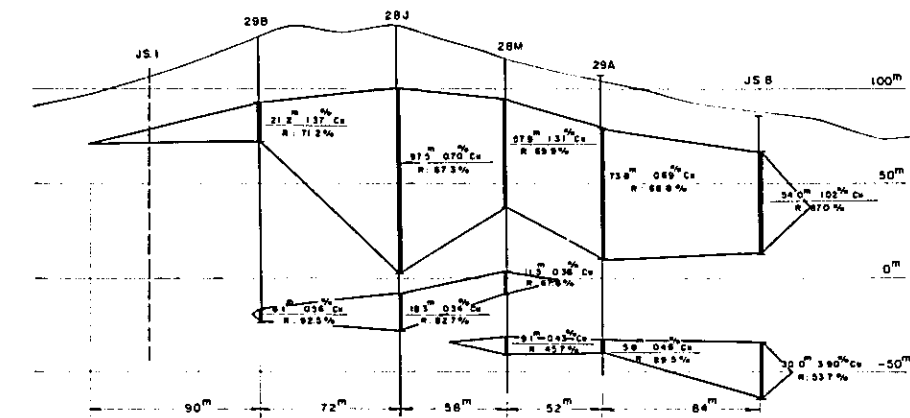

5 - 5

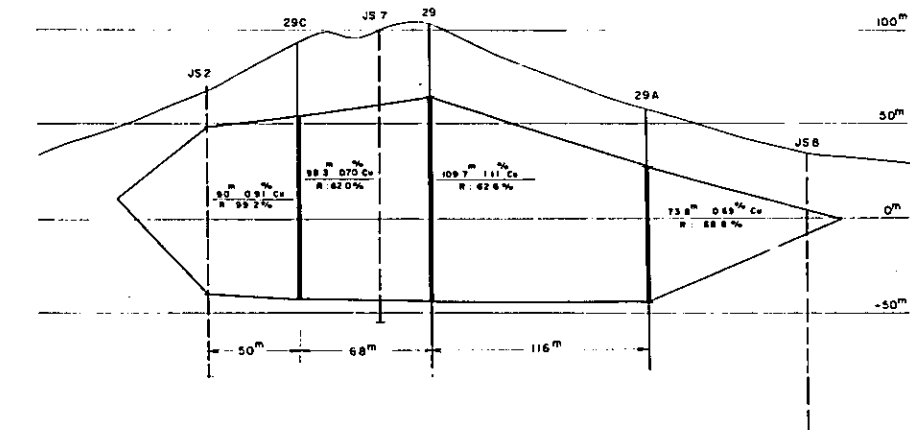

5(1) - 5(1)

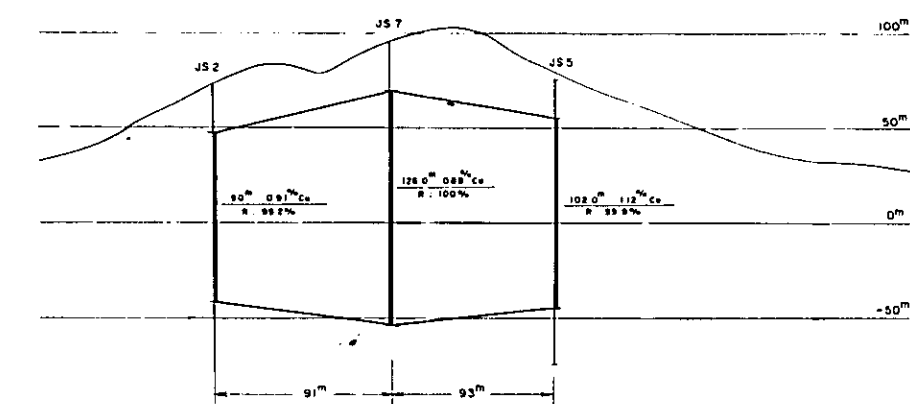

国際協力事業団
08816
国書大科定蔵書

PL.I-12

GEOLOGICAL SURVEY OF
MONywa AREA UNION OF BURMA
(PHASE II)
PLAN AND SECTION FOR
THE ORE RESERVE ESTIMATION OF
SABEDAUNG ORE DEPOSIT

Scale 1:2,000
0 50 100

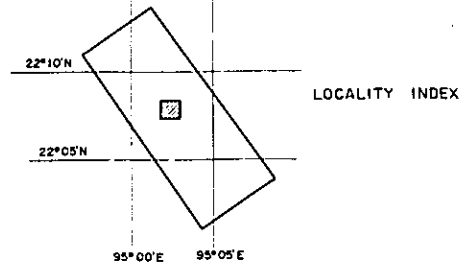

METAL MINING AGENCY
OVERSEAS TECHNICAL COOPERATION AGENCY
GOVERNMENT OF JAPAN
SEPTEMBER 1974
Prepared by MITSUI KINZOKU ENGINEERING SERVICE CO., LTD.

LEGEND

- 1 Block number
- Section line number
- O Area of the orebody on the section
- Length and grade of each drill hole (cut off 0.3%cu)
R: core recovery
- Drill hole on the section
- Drill hole projected

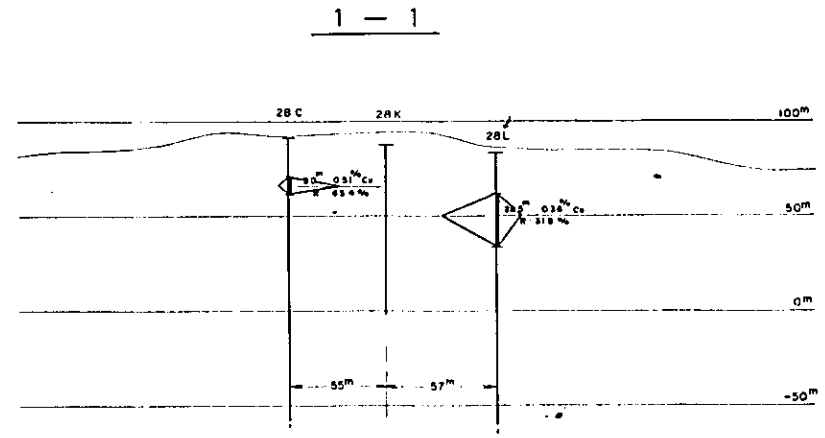
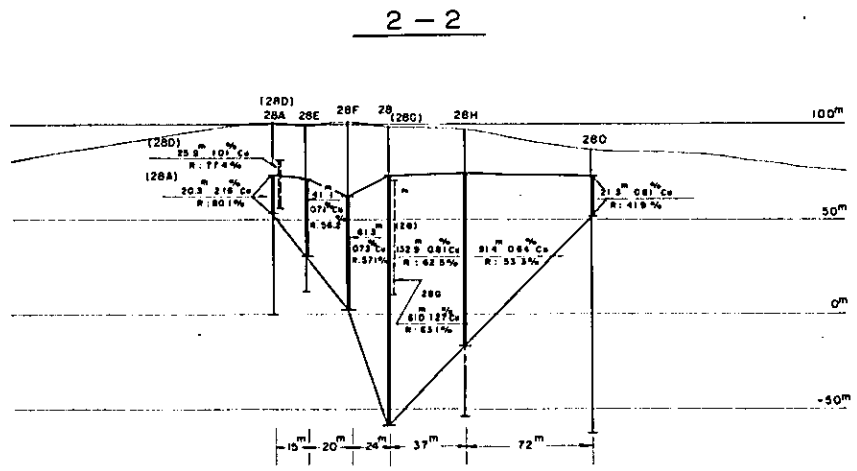
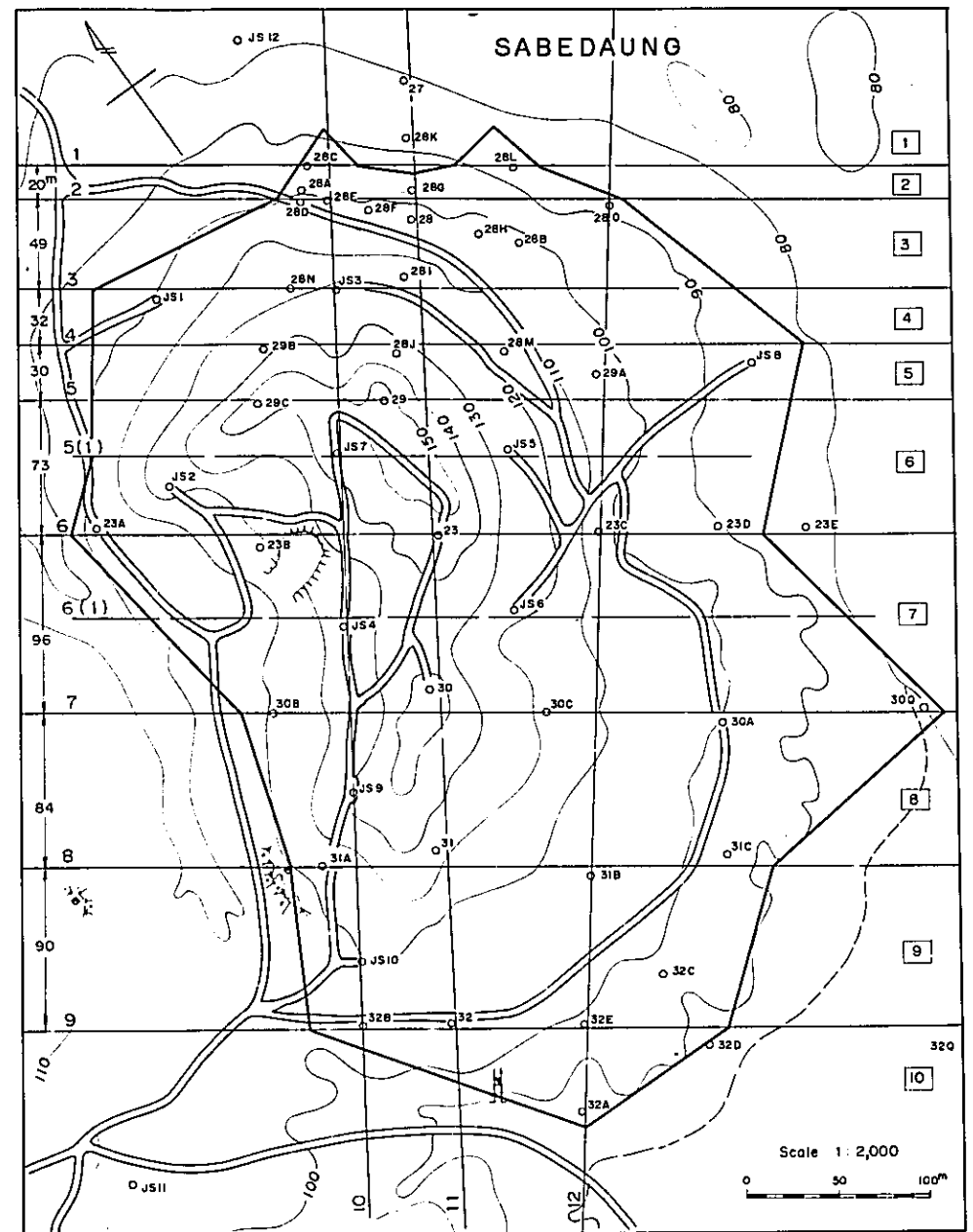
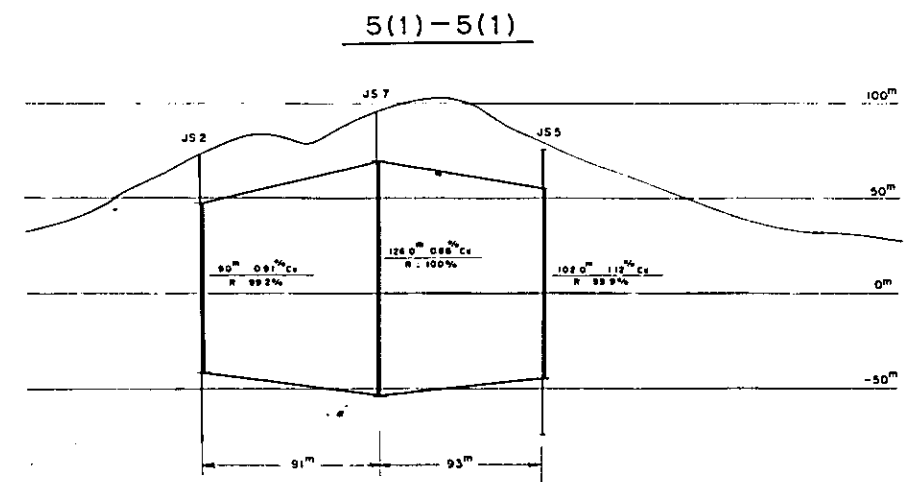
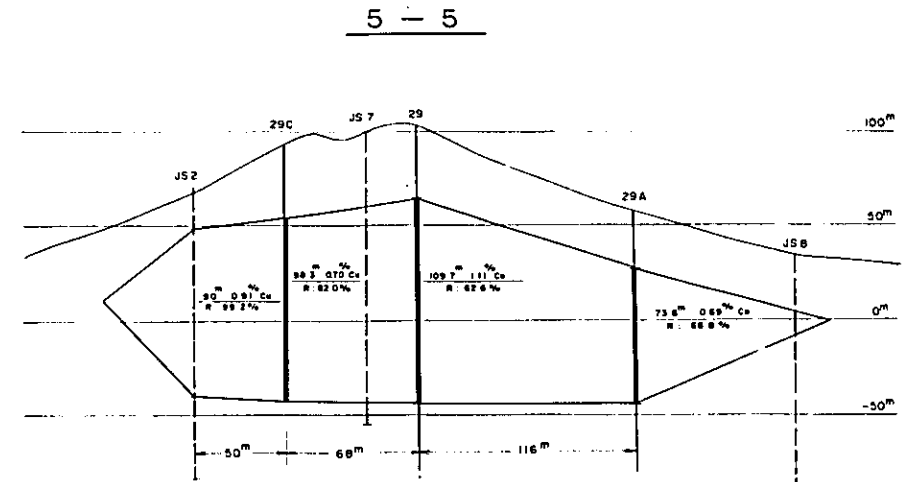
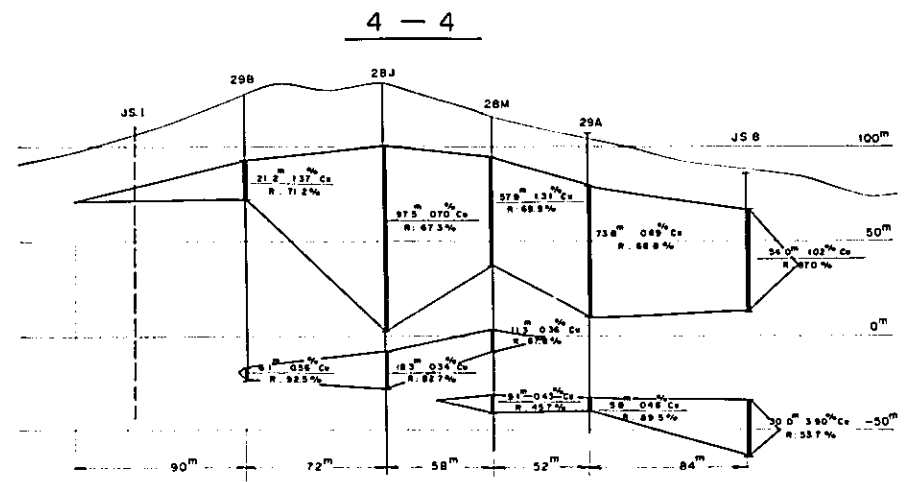
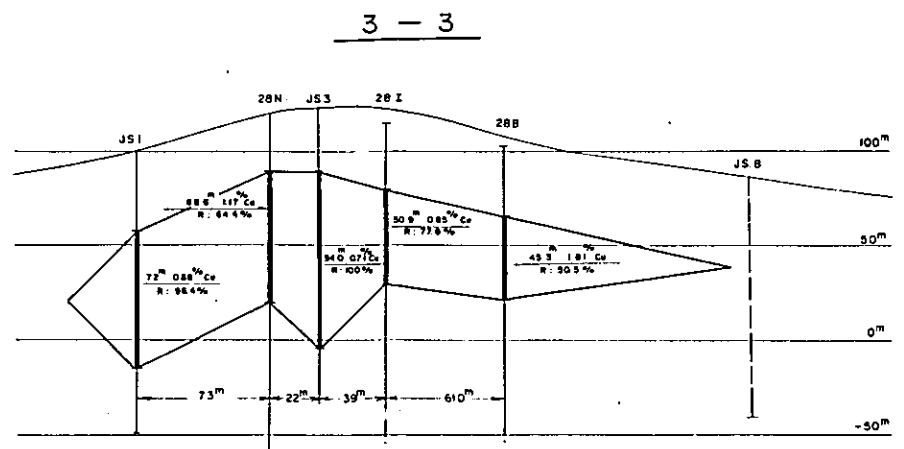

11 - 11

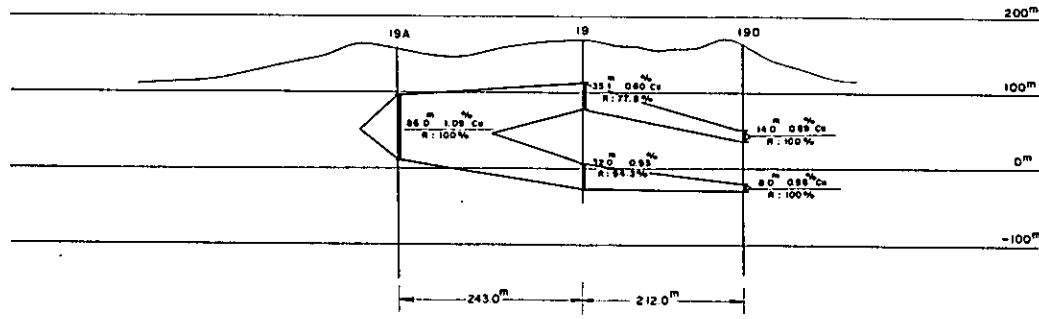

7 - 7

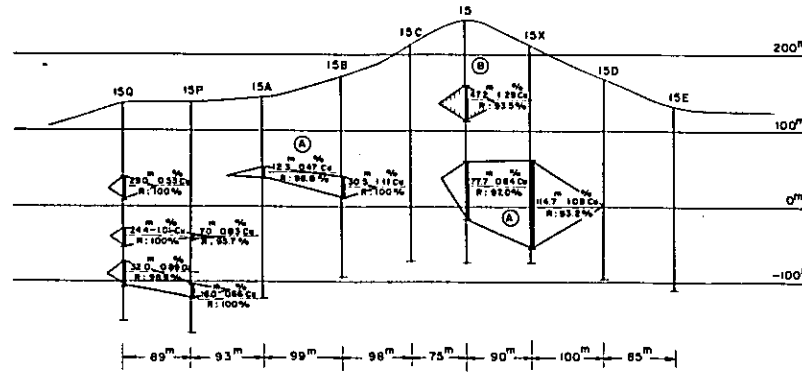

3 - 3

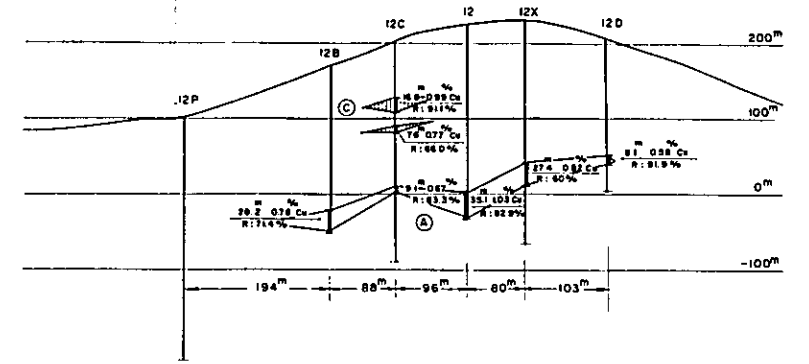

12 - 12

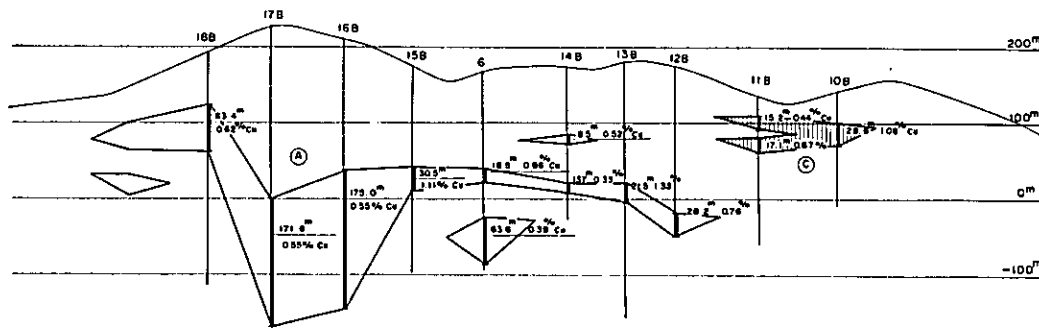

8 - 8

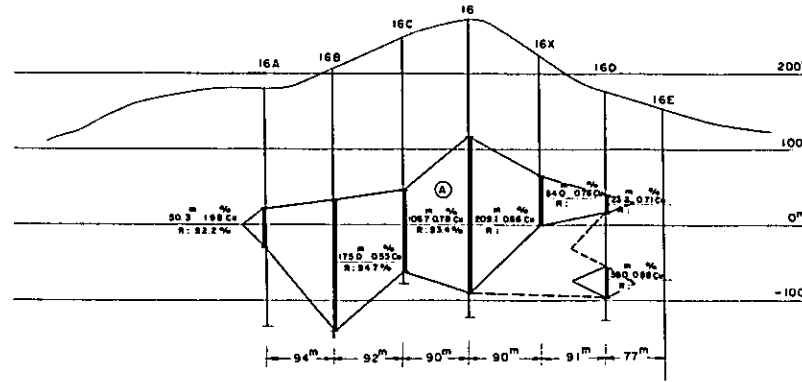

4 - 4

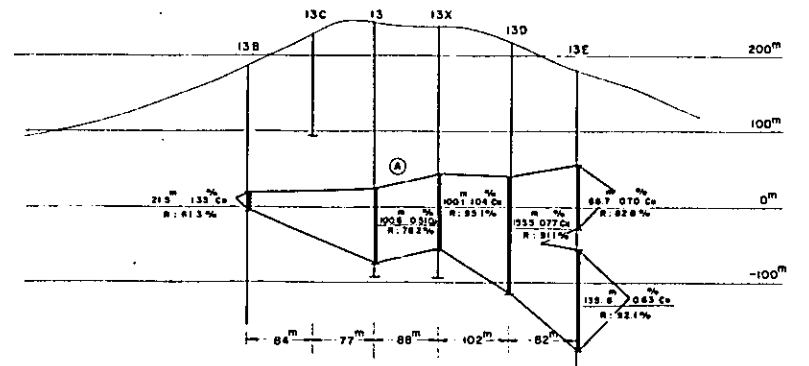

13 - 13

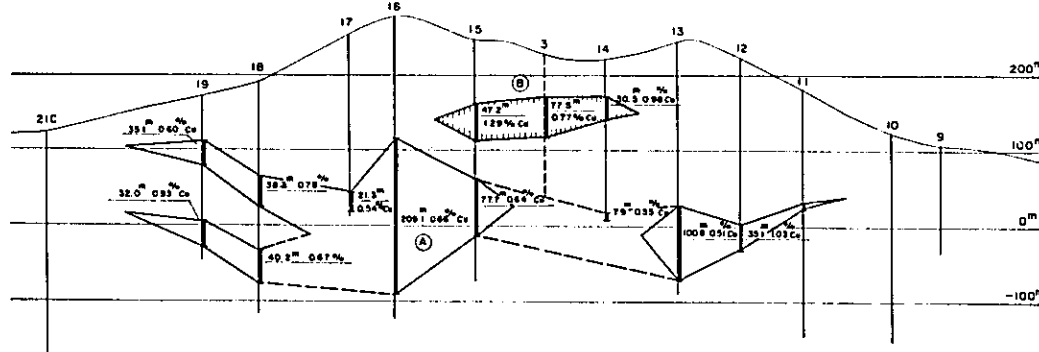

9 - 9

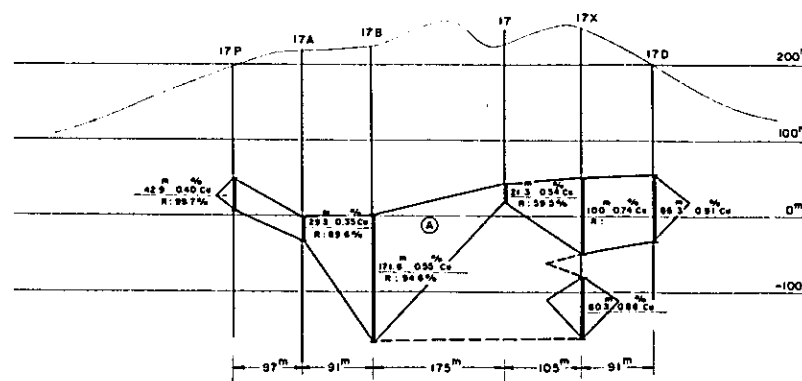

5 - 5

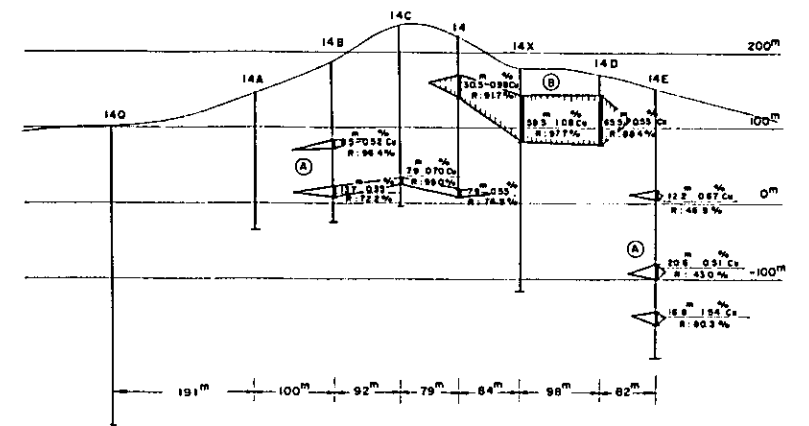

14 - 14

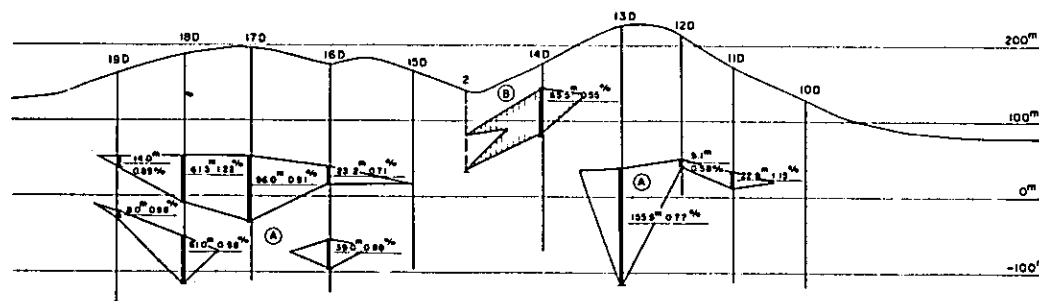

10 - 10

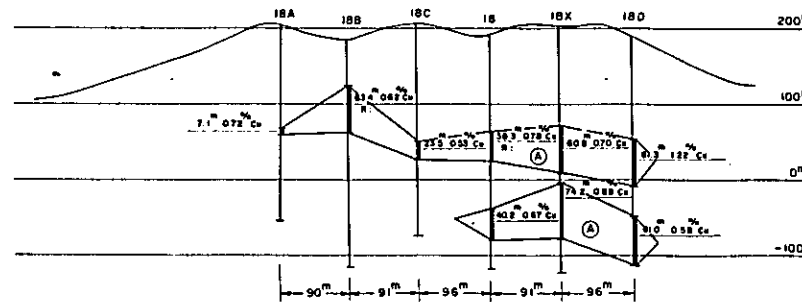

6 - 6

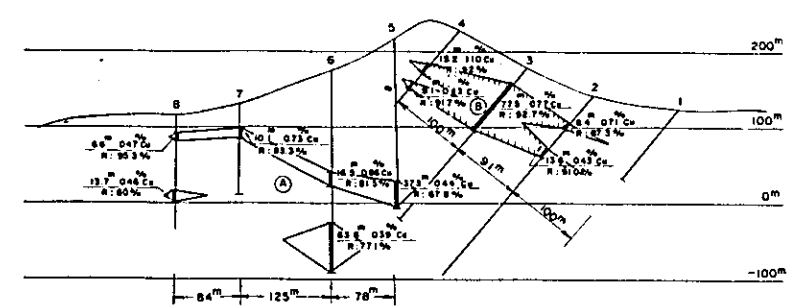

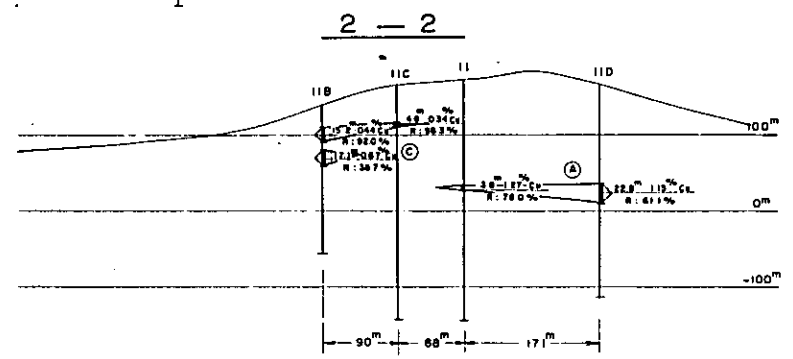
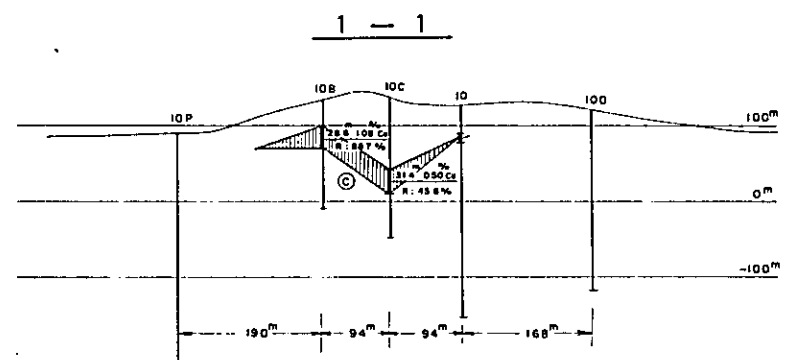
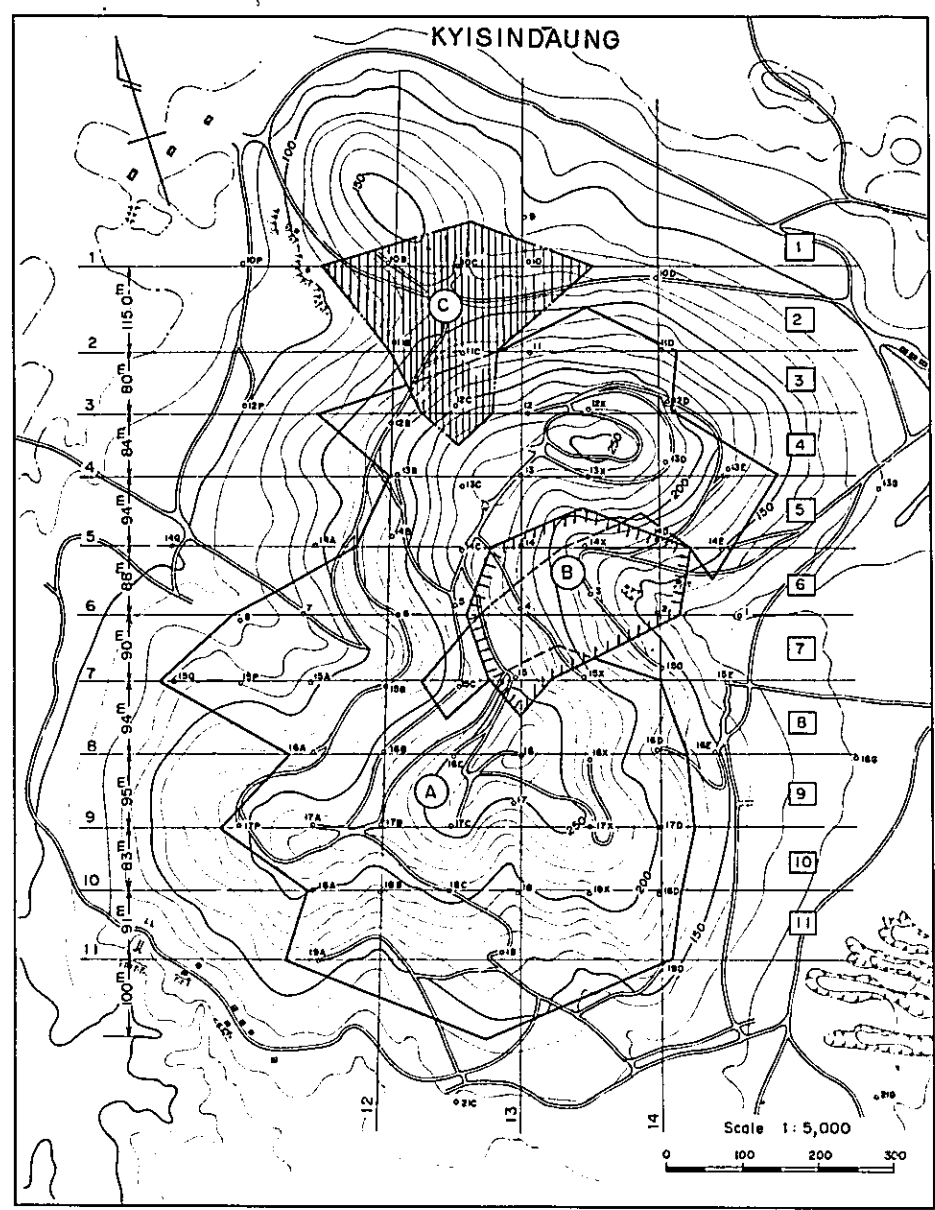
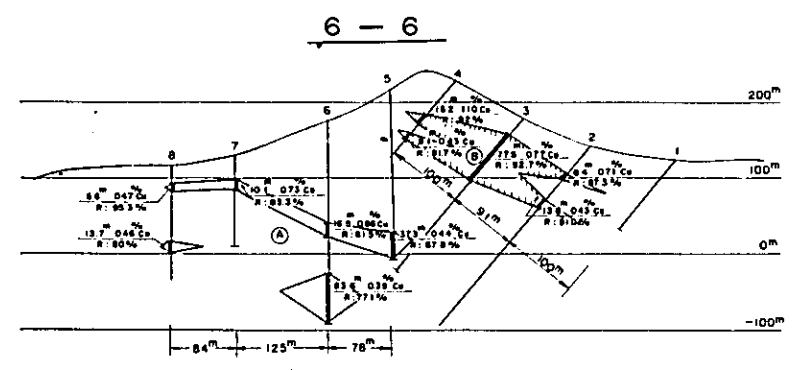
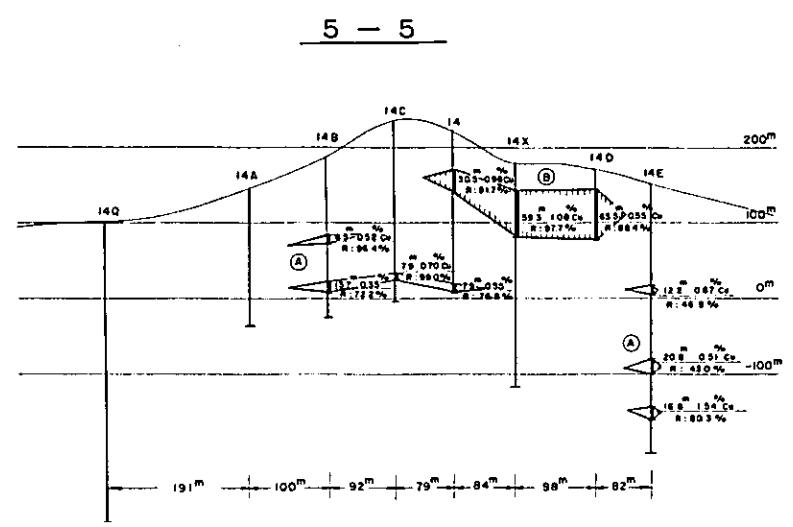
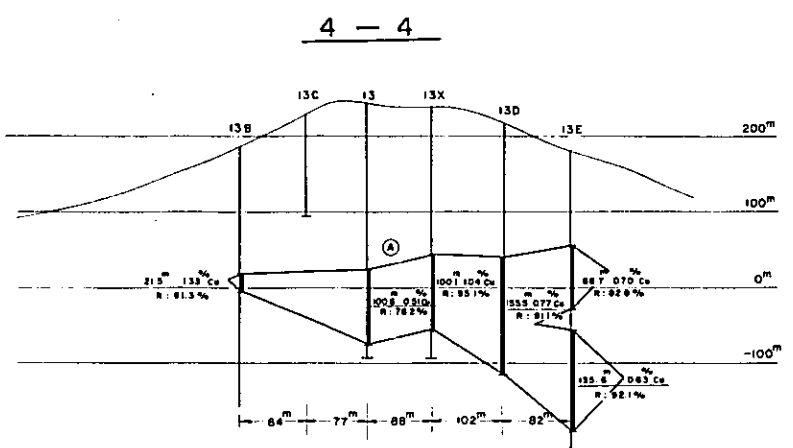
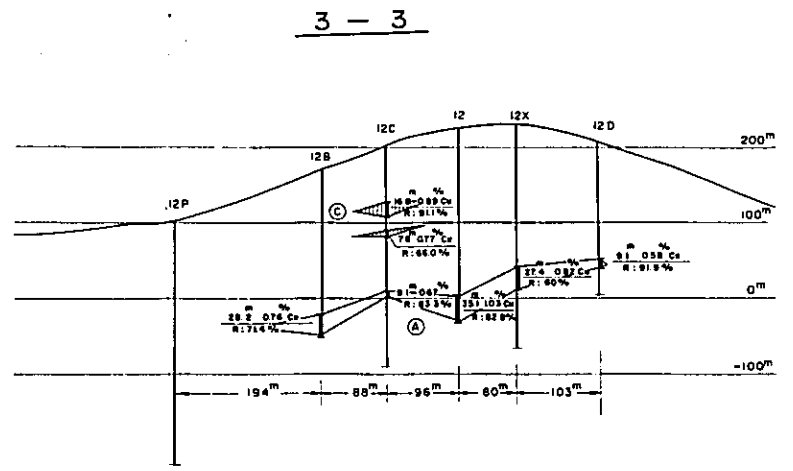

国際協力事業団
08816
国書刊行会

PL.I-13

GEOLOGICAL SURVEY OF
MONYWA AREA UNION OF BURMA
(PHASE II)

PLAN AND SECTION FOR
THE ORE RESERVE ESTIMATION OF
KYISINDAUNG ORE DEPOSIT

Scale 1:5,000

0 100 200 300

22°10'N
22°05'N

95°00'E 95°05'E

LOCALITY INDEX

METAL MINING AGENCY
OVERSEAS TECHNICAL COOPERATION AGENCY
GOVERNMENT OF JAPAN

SEPTEMBER 1974

Prepared by MITSUI KINZOKU ENGINEERING SERVICE CO., LTD.

LEGEND

2 Block number

4 Section line number

Area of the orebody on the section

Length and grade of each drill hole (Cut off 0.3%cu)
R: core recovery

Mark for each ore body

Drill hole on the section Drill hole projected

13D 2

()