

SERIES 1501 (A)
SHEET NA 47-12
EDITION 3 GSGS

1:250,000 JOG (A)
DUMAI
INDONESIA
NA 47-12

LEGEND

POPULATED PLACES
Towns
Villages
1st importance PALEMBANG
2nd importance DJAMBI
3rd importance SEKAU
4th importance Dumai
5th importance Pangkalansera

ROADS
All weather hard surface
Two or more lanes wide
Less than two lanes wide
All weather loose or light surface
Two or more lanes wide
Less than two lanes wide
Fair or dry weather loose surface dirt road
Carpet
Trail/footpath

RAILROADS
Normal gauge (1 meter)
Narrow gauge

BOUNDARIES
International
Daerah Tingkat I
Daerah Tingkat II
Kotabatas
Spot elevation normal
Spot elevation critical
Horizontal control point, Trig Astro
Levee, Escarpments
Woodland
Swamp
Tropical grass
Swamp or marsh
Mangrove, Nipa
Reef Limit of danger
Rocks, sunken, awash, Sand
Foreshore fist

Power transmission line
CAUTION: Power line information has been extracted from the most reliable source available. However, there is no assurance that all power lines are shown.

ASBESTOS
EDINA
725

CONTROLLED AIRSPACE
ATLANTIC ADIZ
MONTREAL SIZ

Annex 5-3 Electric Power System Development Project
in Central Sumatra
Location Map - 3

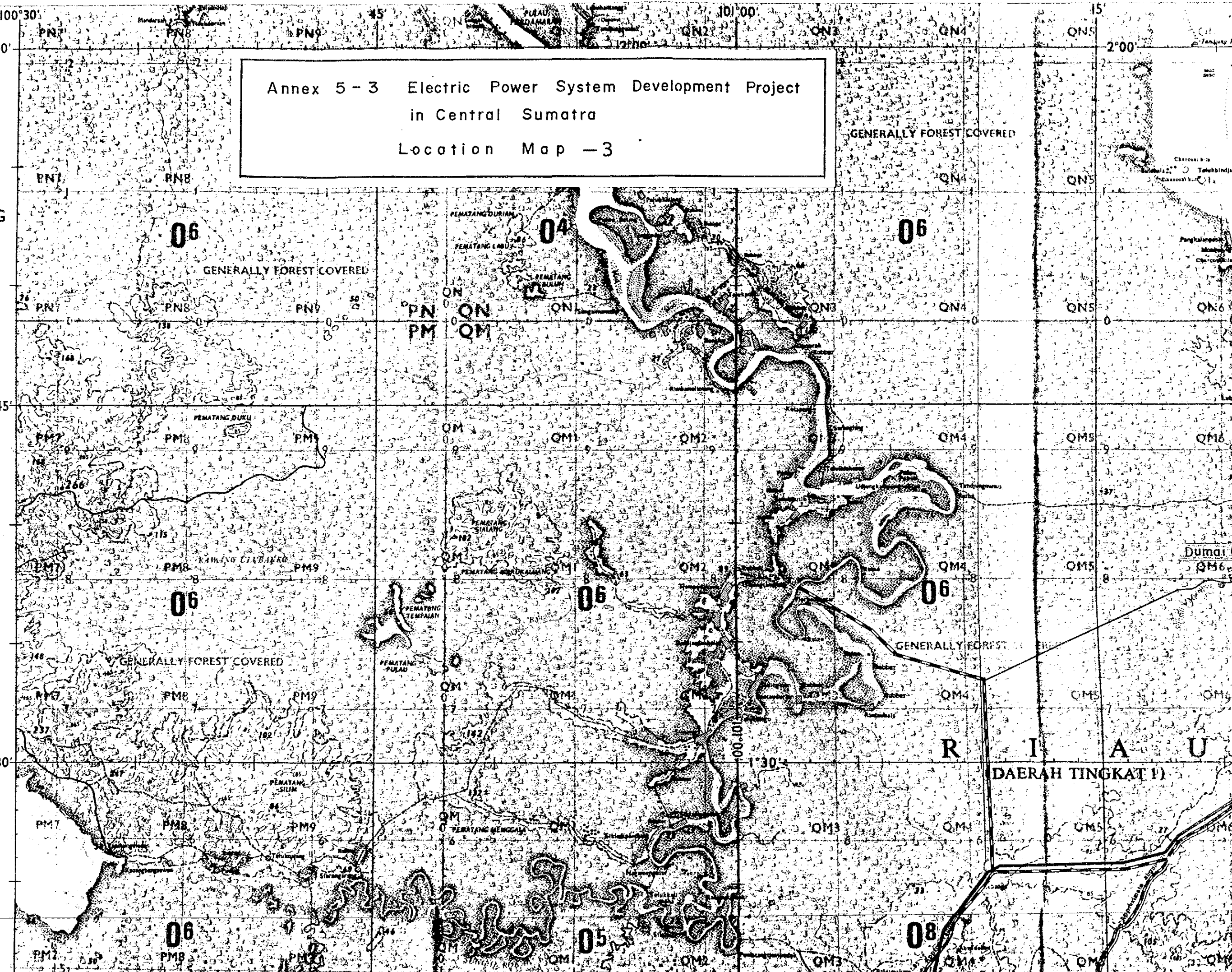

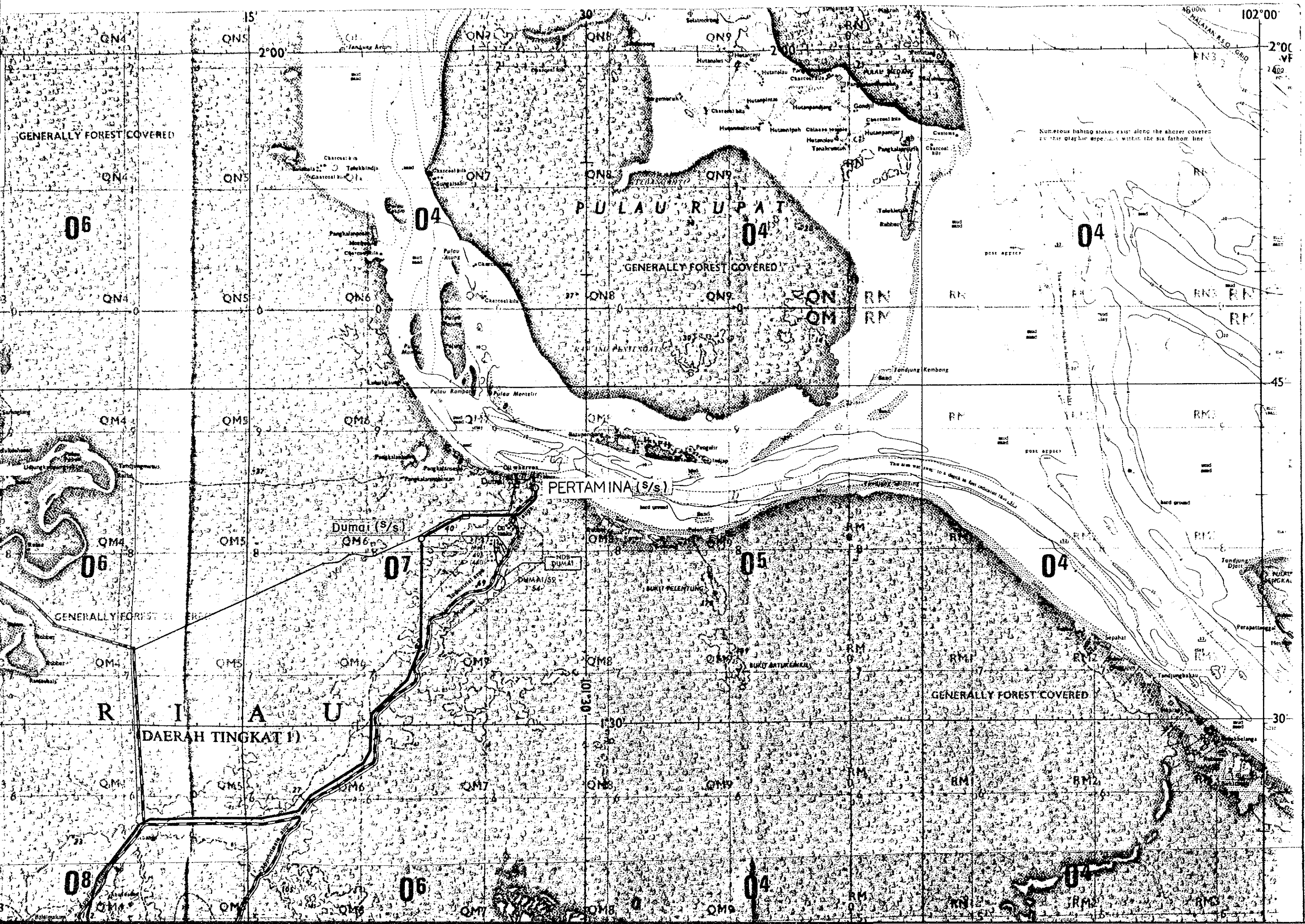

GENERALLY FOREST COVERED

Numerous fishing stakes exist along the shores covered by this graphic especially within the six fathom line

06

04

04

04

06

07

05

04

08

06

04

04

DAERAH TINGKAT I)

PERTAMINA (S/S)

Dumai (S/S)

GENERALLY FOREST COVERED

CONTROLLED AIRSPACE
ATLANTIC ADIZ
MONTREAL SIZ

MAGNETIC VARIATION
 Isogonic line ---7 E---

VISUAL AIDS AND OBSTRUCTIONS
 Obstruction
 150' Evaluation of obstruction by the observer
 25' Evaluation of obstruction for a 1000' observer
 Ground contour
 Radio to obstruction
 Ocean station light (Normal position)
 Vessel ground light
 Aircraft - Marine light

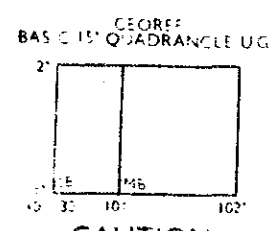

CAUTION
 AIF INFORMATION CURRENT
 Consult NOTAMS and RAF Flight Information Publications for the latest air information

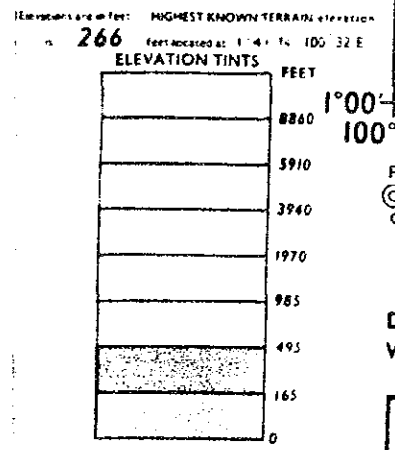

Published by D Survey, Ministry of Defence, United Kingdom, 1967
 © CROWN COPYRIGHT 1967
 Compiled by Ordnance Survey in 1967

DISTRIBUTION LIMITED-DESTROY
WHEN NO LONGER NEEDED



ATTENTION
 THIS CHART CONTAINS
MAXIMUM ELEVATION FIGURES (MEF)
 The Maximum Elevation Figures shown in quadrangles bounded by ticked lines of latitude and longitude are represented in THOUSANDS and HUNDREDS of feet above mean sea level. The MEF is based on information available concerning the highest known feature in each quadrangle including terrain and obstructions (trees, towers, antennas, etc.). In areas of extensive unrelieved relief the MEF is shown by a note spaced across the area.
 EXAMPLE: 12 600 feet

1:250,000 JOG (A)
DUMAI
INDONESIA
NA 47-12

SERIES 1501 (A)
 SHEET NA 47-12
 EDITION 3 GSGS

NOTES
 THIS GRAPHIC IS NOT AN AUTHORITY ON INTERNATIONAL BOUNDARIES

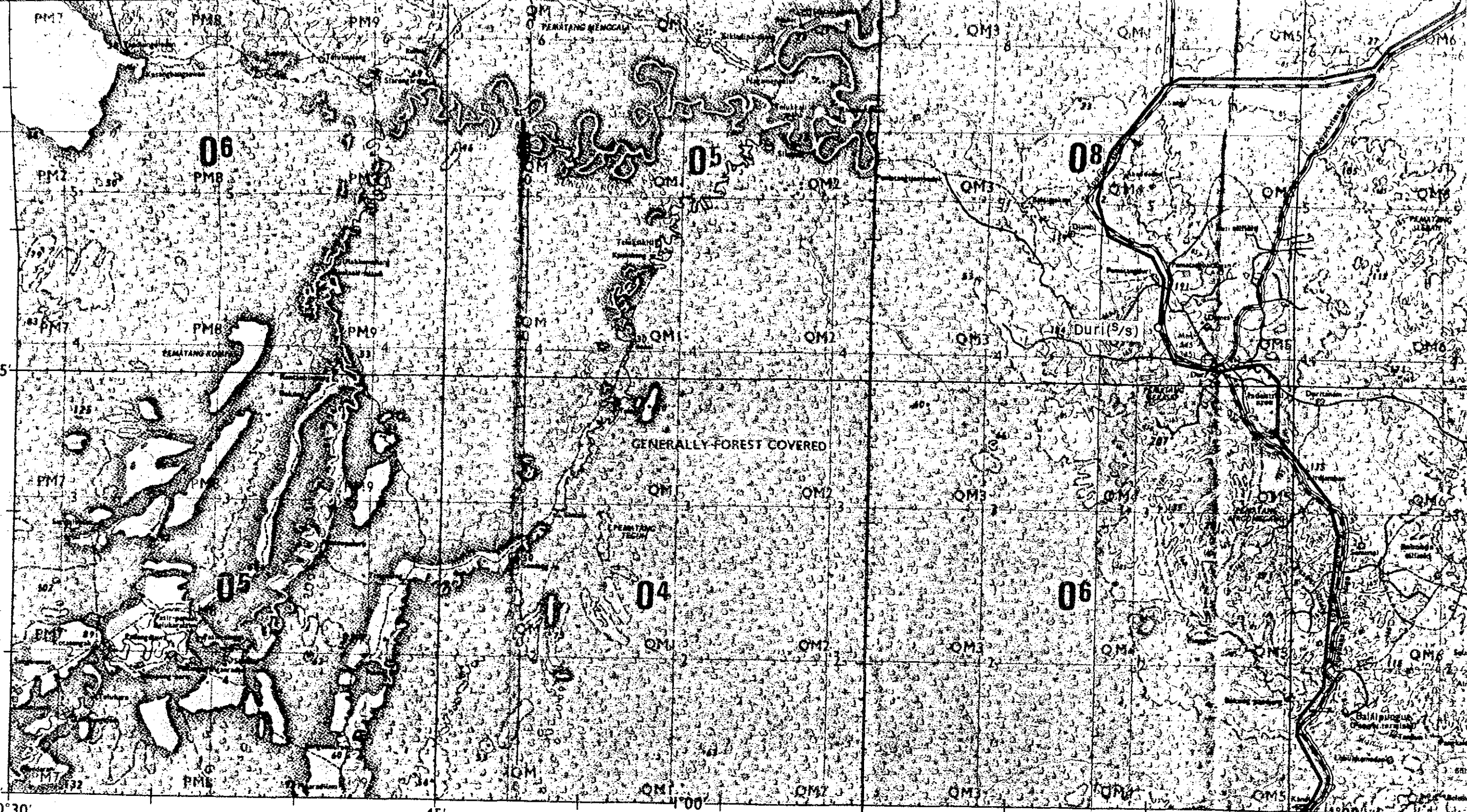

ELEVATIONS IN FEET

JOINT OPERATIONS GRAPHIC - A
 Scale 1:250,000

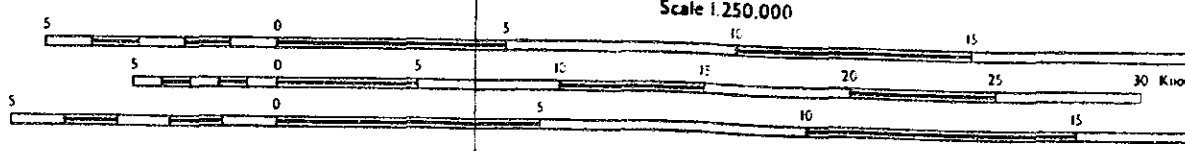

SUPPLEMENTARY CONTOURS AT INTERVALS OF APPROXIMATELY 85 FEET (25 METRES)

Supplementary contour
 TRANSVERSE MERCATOR PROJECTION

BROWN NUMBERS INDICATE THE 50-YARD HALF-RECTIFIED SPHERICAL GRID (EVEREST SPHERE)

USERS SHOULD REFER TO CORRECTIONS, ADDITIONS AND COMMENTS FOR IMPROVING THIS PRODUCT TO:
 (US Users) Director, Defense Mapping Agency Aeronautics Center, 51 Louis AF 5 Missouri 63116, ATTN: DF
 (UK Users) Directorate of Military Survey, Ministry of Defence, London

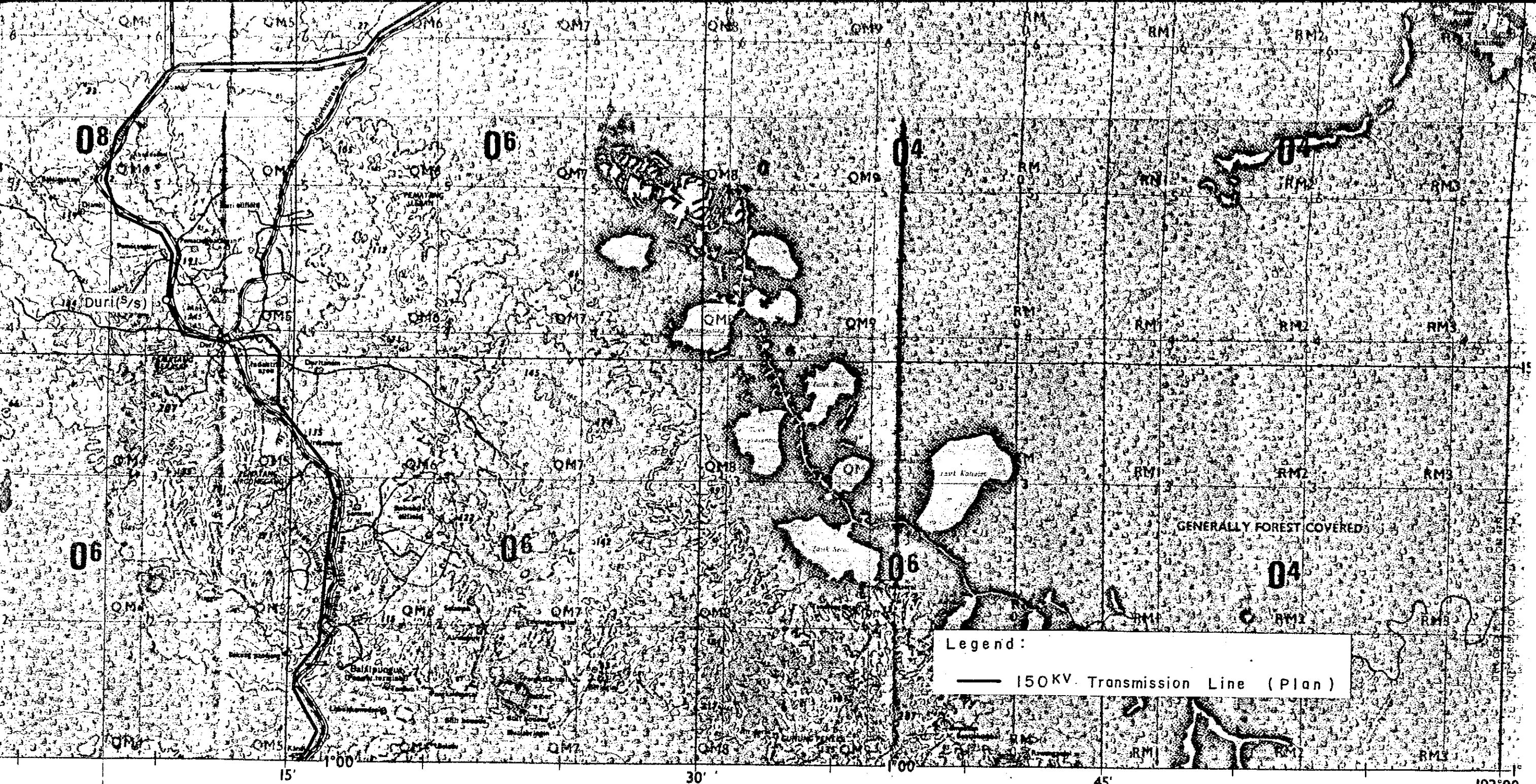

ELEVATIONS IN FEET

PRINTED BY DEFENSE MAPPING AGENCY HYDROGRAPHIC/TOPOGRAPHIC CENTER 579

AIRCRAFT OPERATIONS GRAPHIC-AIR

Scale: 250,000

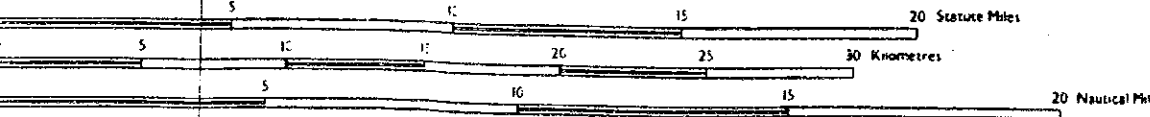

SUPPLEMENTARY CONTOURS AT INTERVALS OF APPROXIMATELY 85 FEET (25 METRES)

Supplementary contour

TRANSVERSE MERCATOR PROJECTION

BROWN NUMBERED LINES INDICATE THE 100-YARD NAIP RECTIFIED SYSTEM ORTHOGRAPHIC GRID EVEREST SPHEROID

LOCATION DIAGRAM FOR NA 47-12

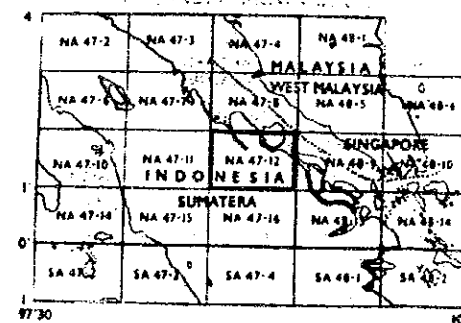

GLOSSARY

Air	River	Pegunungan	Mountain
-Barat	-Barat	Pematang	Marsh
Basang, B.	River	Pulau, P.	Island
Batu	Rock	Pentjak	Pass
Bukit, B.	Hill	Rawa, Rawang	Marsh, Swamp
Daerah Tingkat	Administrative Division	Selat	Strait
Danu, D.	Lake	-selatan	South
Delok	Mountain	Sungai, S.	River, Stream
Gunung	Mountain	Talang, T.	Plateau
Kepulauan	Archipelago	Tanjung, Tg.	Cape, Head
Kuala	Estuary, River mouth	Teluk	Bay
Laut	Sea	Tengah (-cangah)	Central (-ward)
Lubuk	Deep pool	Terusan	Channel, Canal
Muara	Estuary	Utara (-utara)	North

STOCK NO. 1501ANA47

A-43

SERIES 1501 (A)
SHEET NA 47-12
EDITION 3 GSGS

USERS SHOULD PREFER CORRECTIONS, ADDITIONS AND COMMENTS FOR IMPROVING THIS PRODUCT TO:
US Users: Director, Defense Mapping Agency Aerospace Center, 5160 AFSC, Maxwell AFB, AL 36115, ATTN: DF
UK Users: Director of Military Survey, Ministry of Defense, London

Annex 5-4 Isokeraunic Level Map

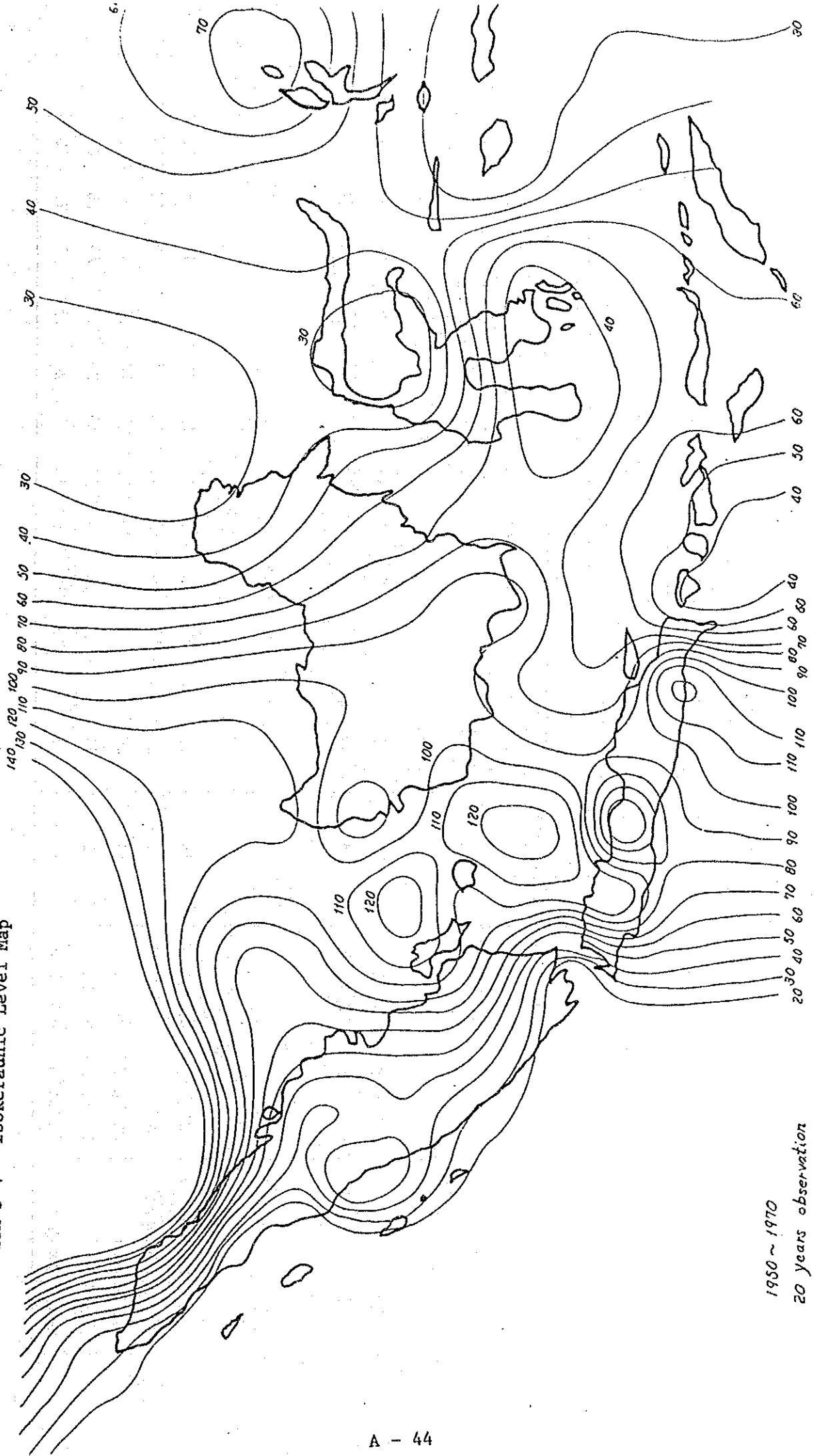

1950 ~ 1970
20 years observation

Annex 5-5 Maximum Wind Velocity

(Unit: knots)

Station	Location	Elevation	Month																					
			Jan	Feb	Mar	Apr	May	Jun	Jul	Aug	Sept	Oct	Nov	Dec										
(West Sumatra)																								
Sukaraml	01°00'S 101°00'W	928	6	8	3	8	8	11	11	8	8	1	8	8										
Tabing - Padang	00°56'S 100°22'W	3	20	35	27	26	21	25	30	30	25	25	29	20										
(Riau)																								
Dabo-Singkep	00°20'S 104°35'W	18	17	15	20	13	12	15	14	13	16	16	16	17										
Japura-Rengat	00°26'S 102°27'W	18	15	12	15	10	13	15	15	15	14	16	12	15										
Pekanbaru	00°28'N 101°26'W	31	20	18	13	15	25	20	18	20	18	15	11	15										
Ranai	03°56'N 108°24'W	2	14			15	18	30	15	20	30	20	20	25										
Tg. Pinang	00°55'N 104°32'W	14	18	20	25	16	18	18	17	20	15	15	17	16										

Annex 5-6 Monthly Mean Daily Temperature

(Unit: °C)

Month	Pekanbaru (1961-1979)			Pasar Kampar (1976-1981)			Japura-Rengat (1961-1979)			Tanjung Pati- Payakumbuh (1975-1982)			Tabing-Padang (1971-1979)		
	Mean	Max.	Min.	Mean	Max.	Min.	Mean	Max.	Min.	Mean	Max.	Min.	Mean	Max.	Min.
Jan.	24.4	32.7	20.7	26.8	34.5	19.4	25.9	32.1	20.9	24.1	34.0	12.5	26.0	31.1	21.0
Feb.	26.1	33.2	20.6	27.3	35.3	18.7	26.2	31.5	20.5	24.1	33.5	15.5	25.9	31.5	21.9
Mar.	26.6	34.0	20.8	27.8	35.7	18.1	26.6	33.8	21.2	25.2	34.5	16.5	26.1	31.1	20.5
Apr.	26.9	33.7	21.2	28.0	36.0	19.1	27.0	33.0	21.8	25.2	33.5	16.0	26.3	31.2	21.7
May	27.1	34.1	21.6	28.2	36.7	19.0	27.3	33.7	21.6	25.6	37.7	13.3	26.4	31.2	22.2
Jun.	26.8	33.5	21.4	27.6	39.5	18.6	27.1	33.7	21.1	24.6	35.5	15.3	26.0	30.8	22.0
Jul.	26.4	33.1	20.7	27.4	35.8	18.2	26.8	32.9	21.2	24.3	40.2	15.1	25.6	30.6	21.4
Aug.	26.2	33.0	20.6	27.7	39.4	16.2	26.6	32.2	21.1	24.3	32.7	15.5	25.6	30.4	21.4
Sept.	26.4	33.0	21.0	27.4	36.2	19.0	26.7	32.6	21.5	24.3	33.5	14.7	25.6	30.3	21.9
Oct.	26.2	33.5	21.4	28.0	37.0	19.0	26.7	32.0	21.6	24.8	39.1	13.2	25.6	30.3	21.1
Nov.	26.1	32.8	21.2	27.5	35.5	20.2	26.4	33.2	21.6	24.6	31.4	18.8	25.6	30.1	21.9
Dec.	25.8	32.8	21.2	27.2	35.3	21.4	26.0	31.7	21.4	24.4	39.5	15.6	25.8	31.1	21.4

Note: Maximum and Minimum show the instantaneous temperature.

Annex 5-7 Monthly Mean Max. and Min. Daily Atmospheric Pressure

Pekanbaru

(Unit: mb)

Year Month	1982		1983		1984		1985	
	Mean	Min.	Mean	Min.	Mean	Min.	Mean	Min.
Jan.	1011.0	1013.4	1011.9	1014.4	1010.0	1012.9	1011.0	1012.3
Feb.	1010.1	1011.9	1011.4	1013.0	1008.9	1010.8	1007.0	1010.7
Mar.	1009.7	1012.2	1010.3	1013.1	1010.1	1011.4	1009.8	1011.4
Apr.	1009.3	1012.6	1009.2	1012.3	1008.9	1011.0	1008.1	1011.2
May	1007.1	1011.7	1009.1	1010.5	1009.0	1010.5	1008.0	1010.1
Jun.	1009.6	1012.7	1009.5	1010.8	1009.0	1010.6	1009.4	1011.7
Jul.	1009.7	1012.1	1009.6	1012.3	1009.1	1010.8	-	-
Aug.	1010.1	1011.9	1009.8	1011.4	1009.4	1011.1	-	-
Sept.	1010.7	1013.2	1010.2	1012.1	1009.7	1013.1	-	-
Oct.	1009.3	1012.5	1009.7	1011.4	1011.0	1013.2	-	-
Nov.	1009.1	1011.4	1011.1	1012.9	1010.2	1011.4	-	-
Dec.	1009.7	1011.9	1010.5	1012.5	1009.3	1012.8	-	-

Annex 5-8 A Type Tower

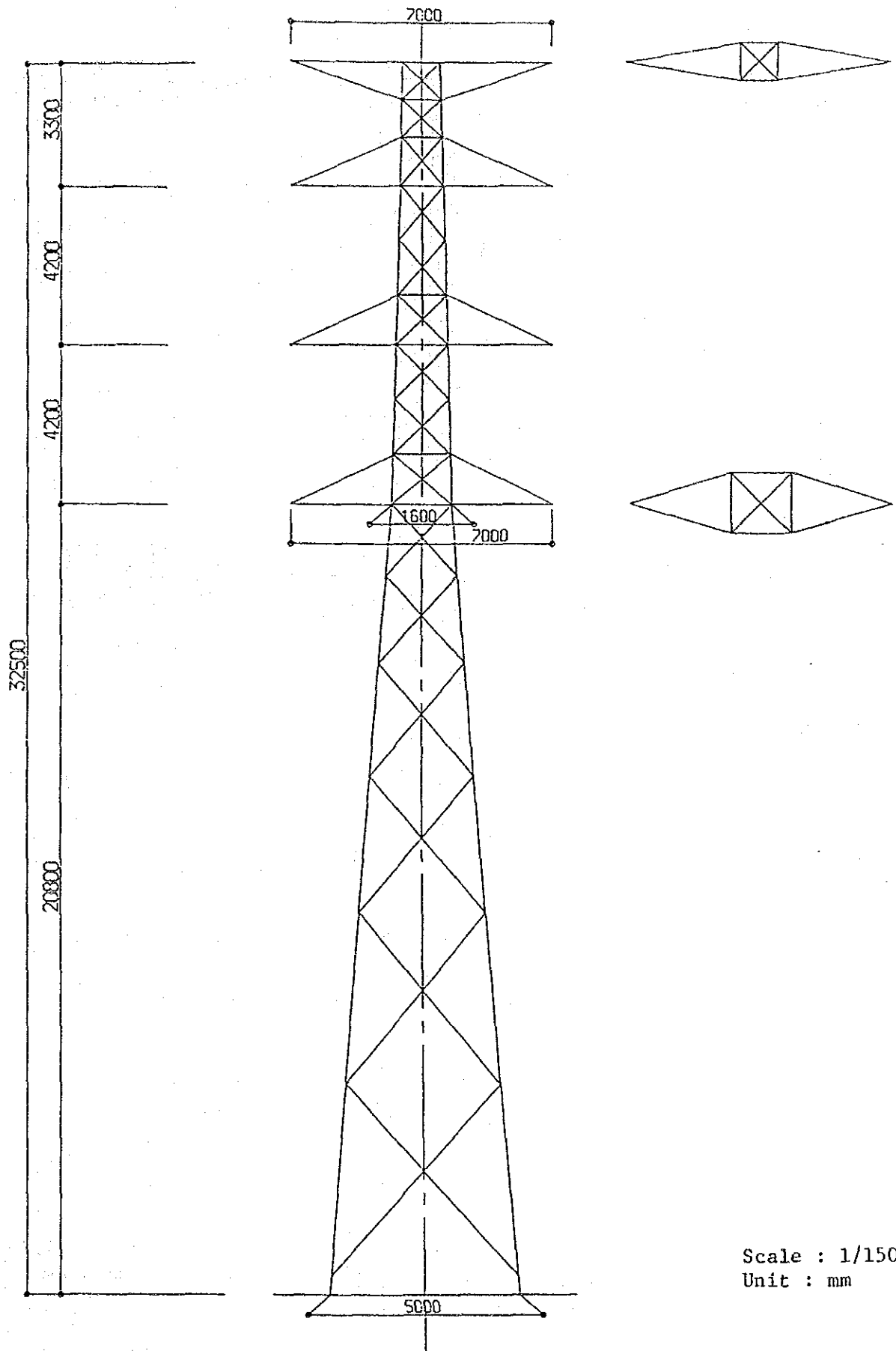

Scale : 1/150
Unit : mm

Annex 5-9 B Type Tower

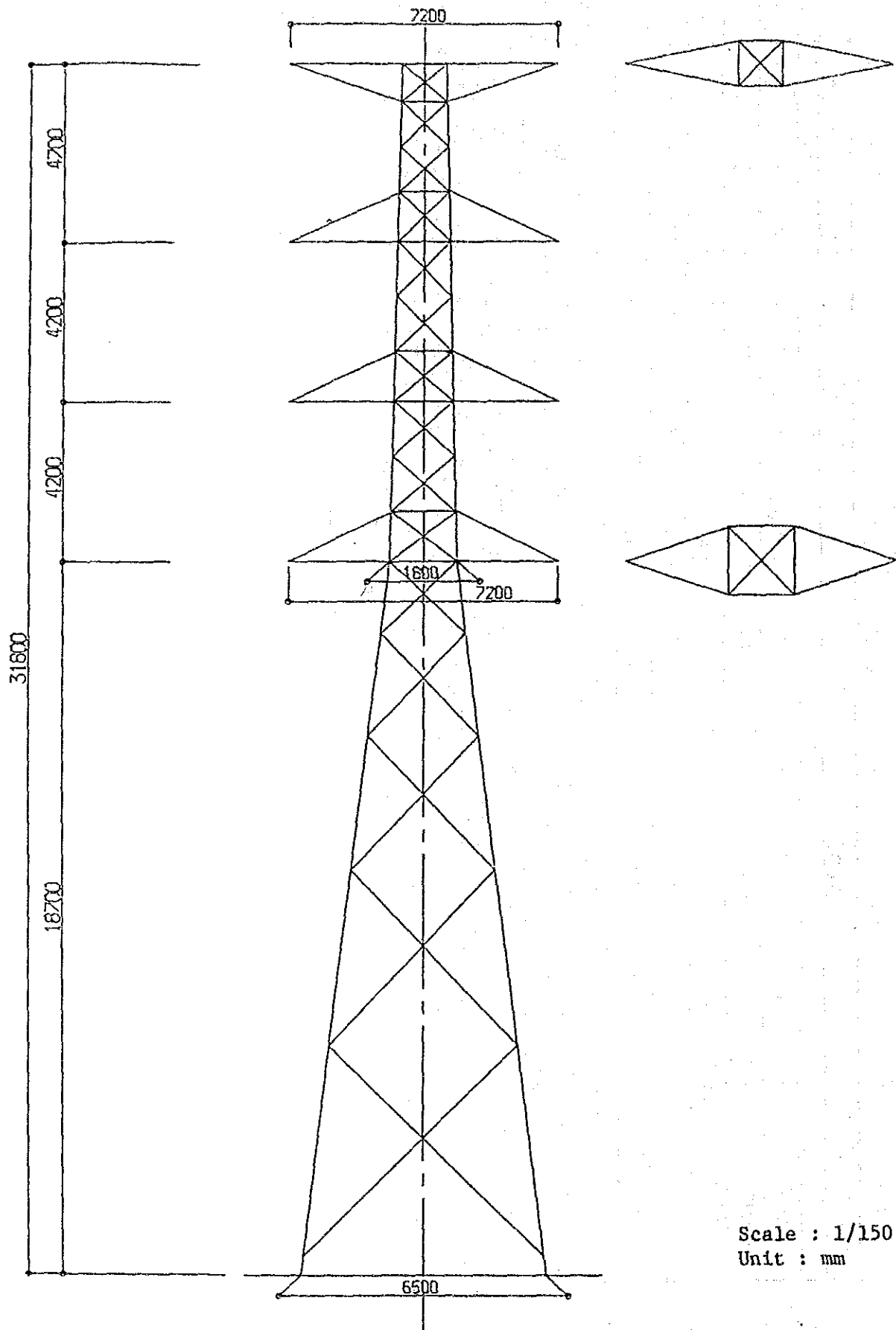

Scale : 1/150
Unit : mm

Annex 5-10 D(K) Type Tower

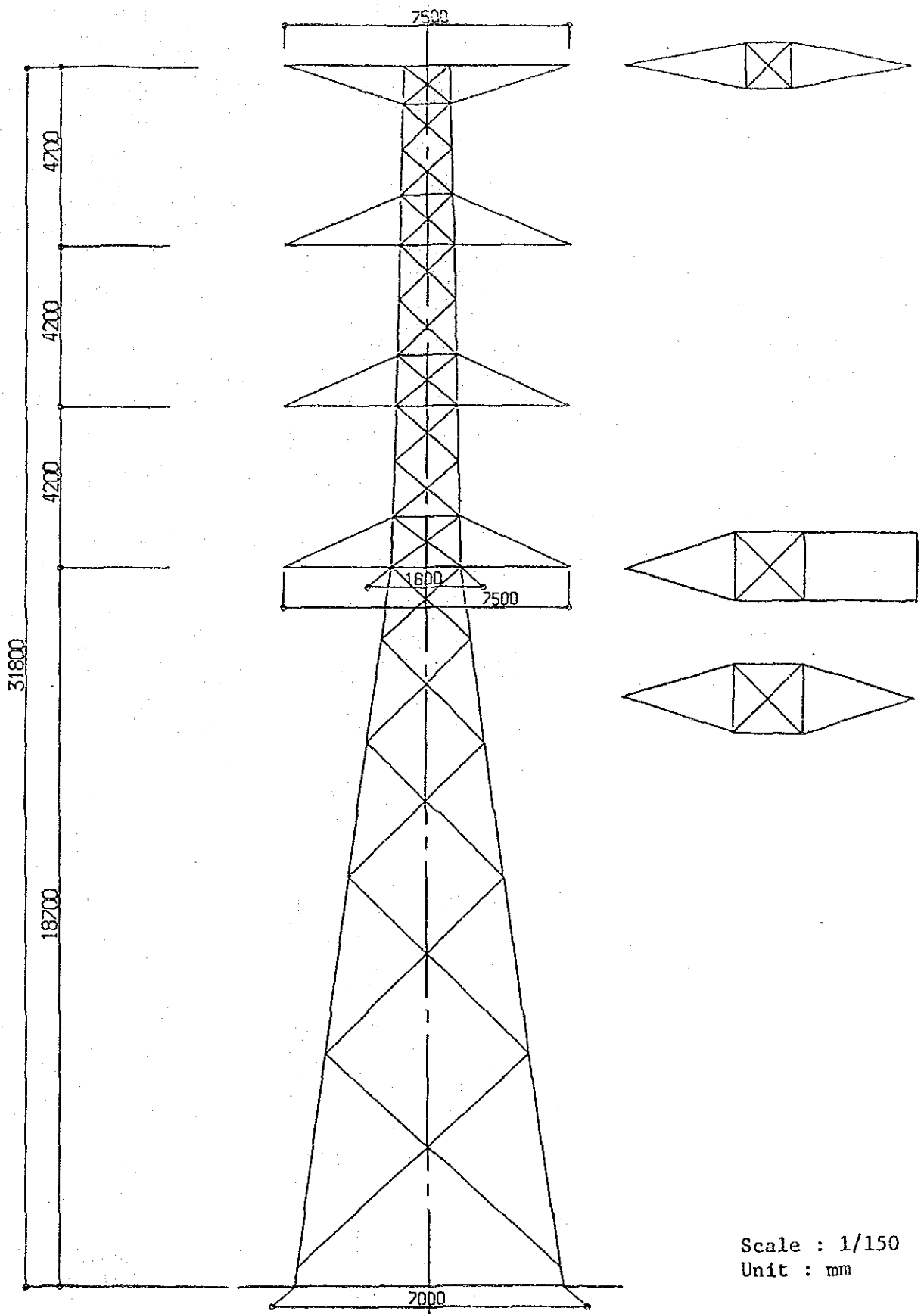

Scale : 1/150
Unit : mm

Annex 5-11 S Type Tower

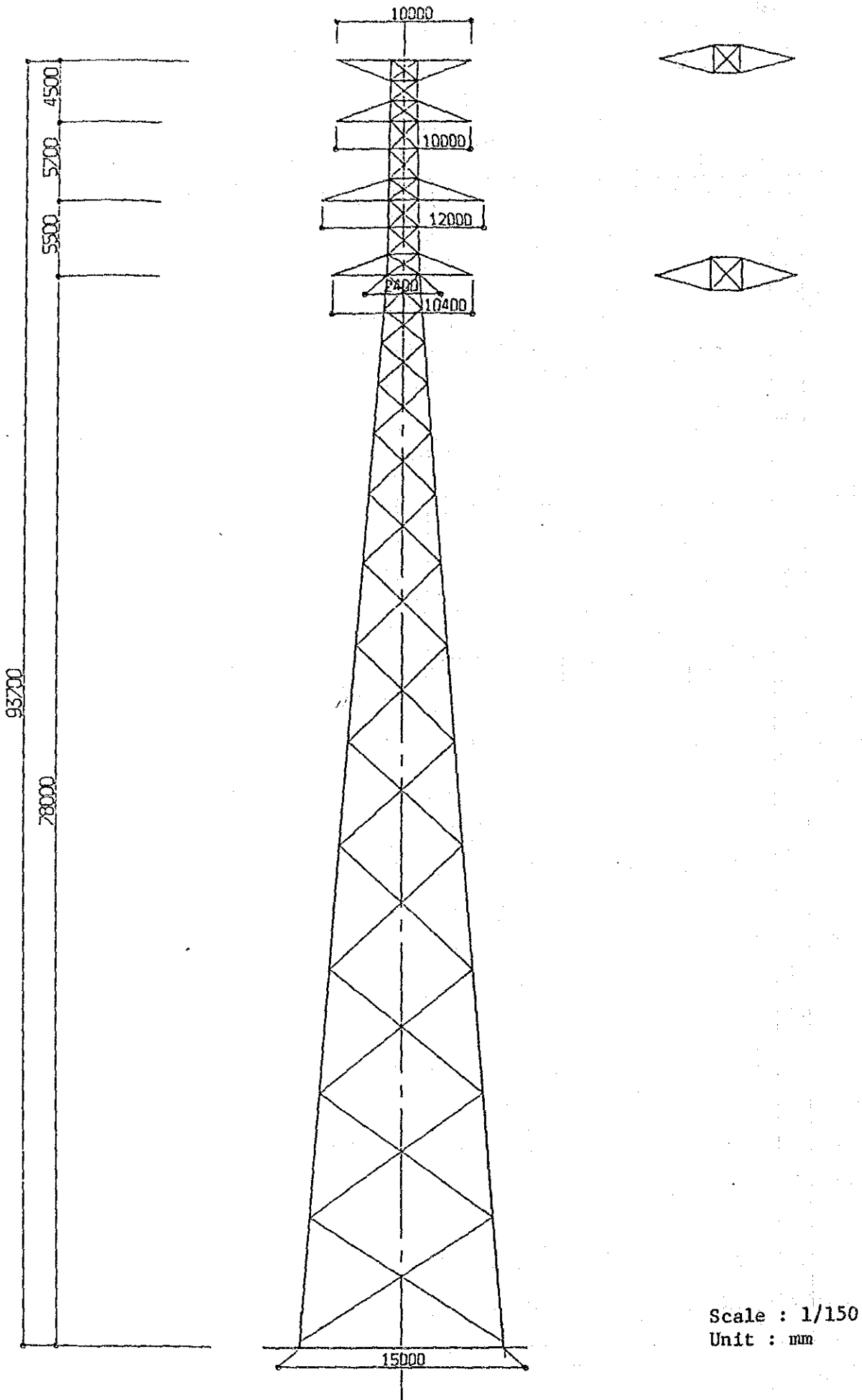

Scale : 1/150
Unit : mm

Annex 5-12 Ground Test by Cone Penetration at Payakumbuh

JIS A 1220	Cone Penetration Log test	Report
------------	---------------------------	--------

Investigation site Payakumbuh North Rice Field Date 12 Sep 1985

Test No. NO. 1 Elevation 450 m Investigator Kimura

Weather Fine Final Depth 2.10 m

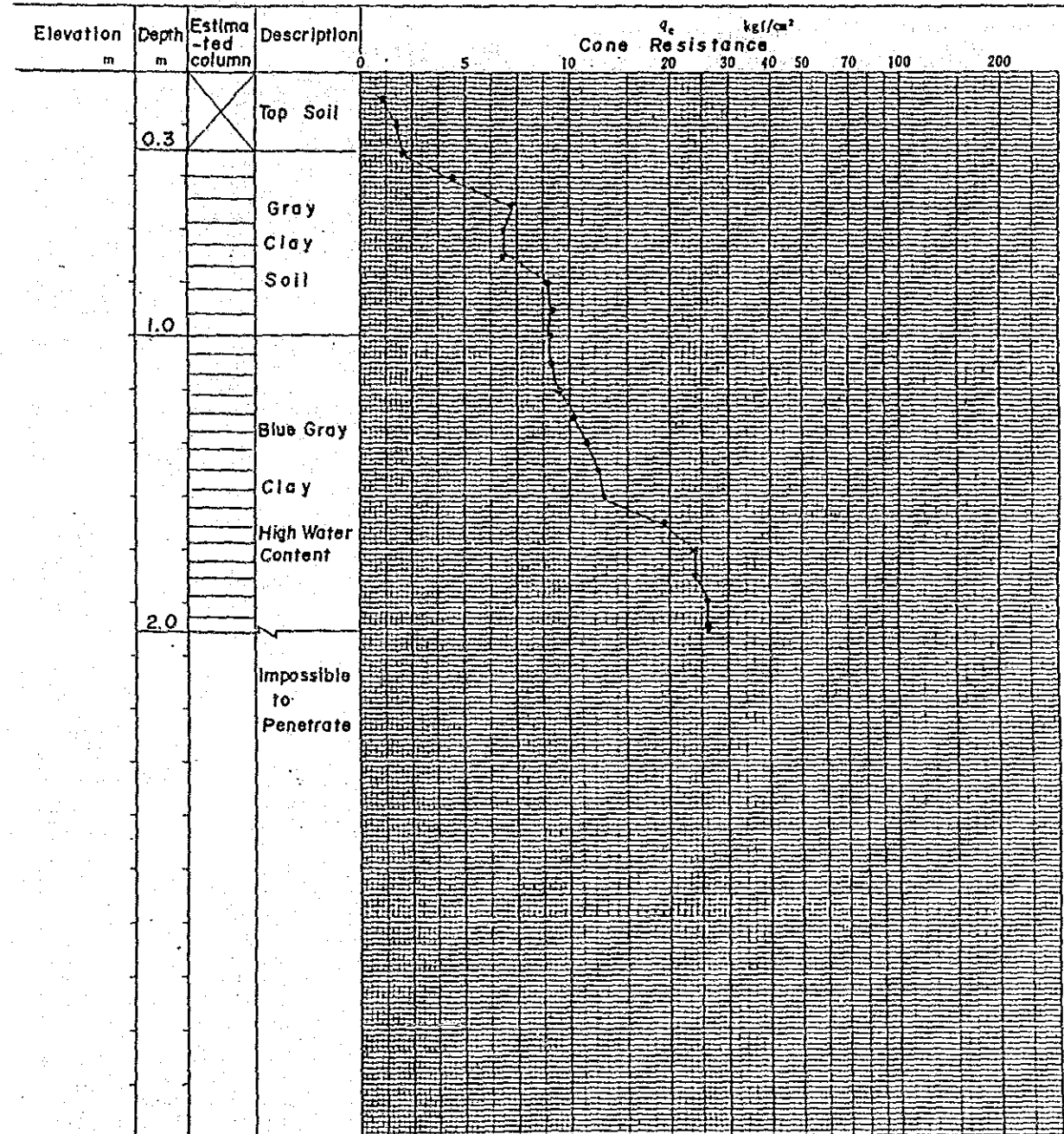

Legend

	Gravel		Clay		Top Soil
	Sand		Peat		

Annex 5-13 Ground Test by Cone Penetration at Pekanbaru

JIS A 1220	Cone Penetration Log test	Report
------------	---------------------------	--------

Investigation site 16 km West to Pekanbaru Date 13 Sept. 1985
 Test No. NO. 4 Investigator Kimura
 Weather Cloudy Final Depth 0.7 m

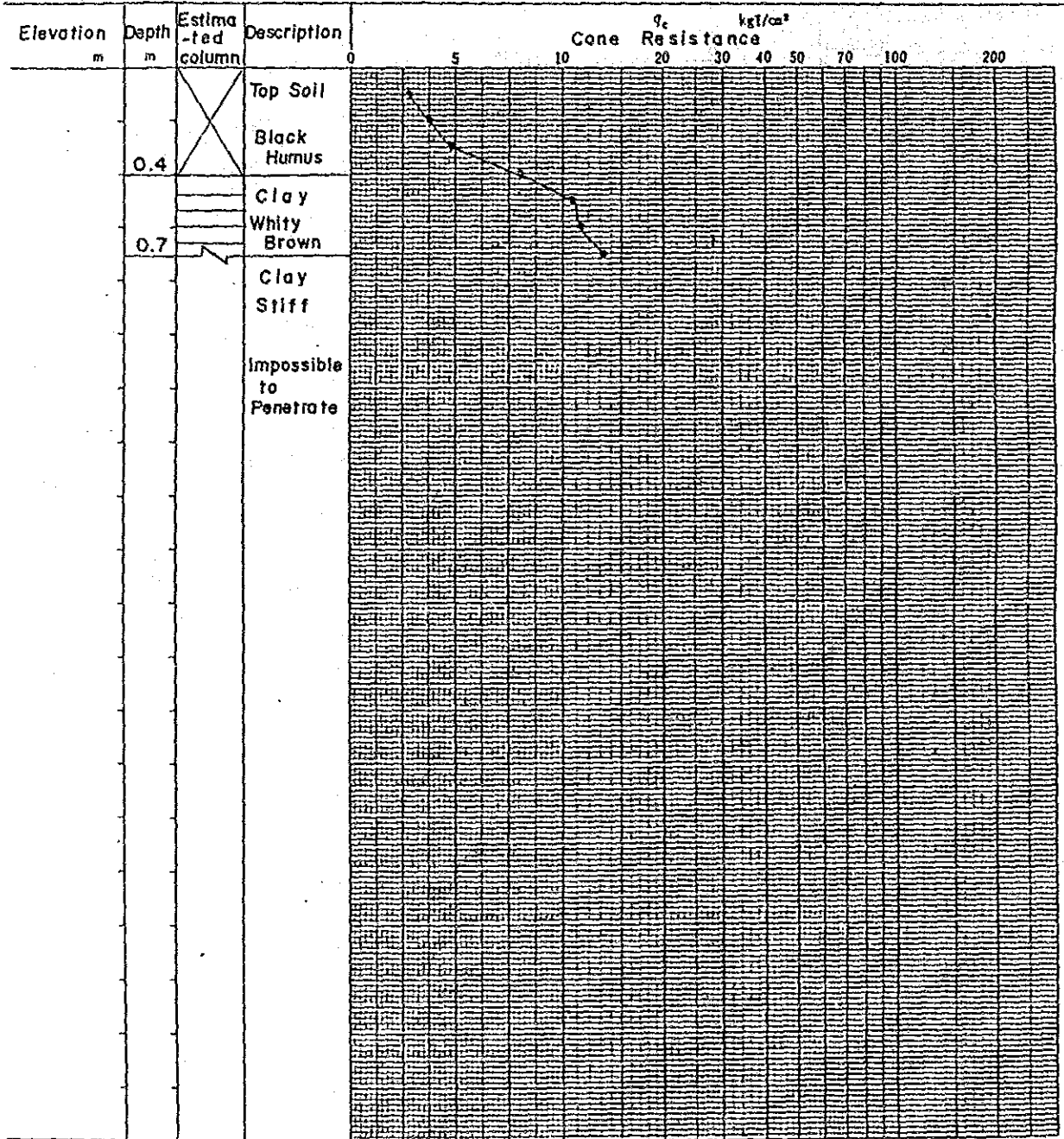

Legend

- Gravel
- Clay
- Top Soil
- Sand
- Peat
-

Annex 5-14 Ground Test by Cone Penetration at Bangkinang

JIS A 1220	Cone Penetration Log test	Report
------------	---------------------------	--------

Investigation site Pekanbaru - Bangkinang Date 14 Sept. 1985

Test No. NO. 3 Elevation _____ Investigator Kimura

Weather Fine Final Depth 3.50 m

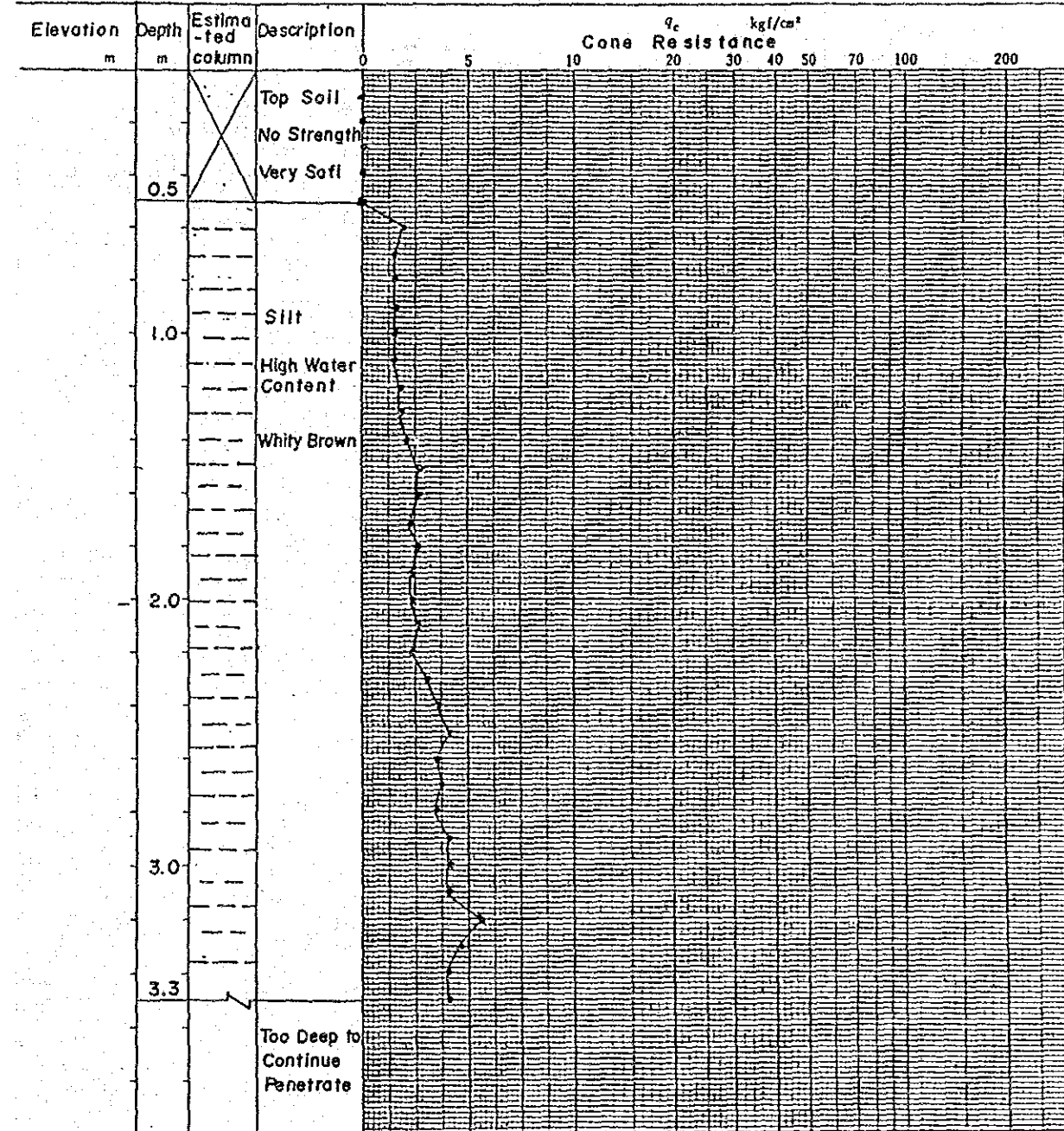

Legend

- Gravel
- Clay
- Top Soil
- Sand
- Peat
- Silt

Annex 5-15 Ground Test by Cone Penetration at Dumai

JIS A 1220	Cone Penetration Log test	Report
------------	---------------------------	--------

Investigation site 16 km North to Dumai Date 17 Sept. 1985

Test No. NO. 2 Elevation _____ Investigator Kimura

Weather Fine Final Depth 0.5 m

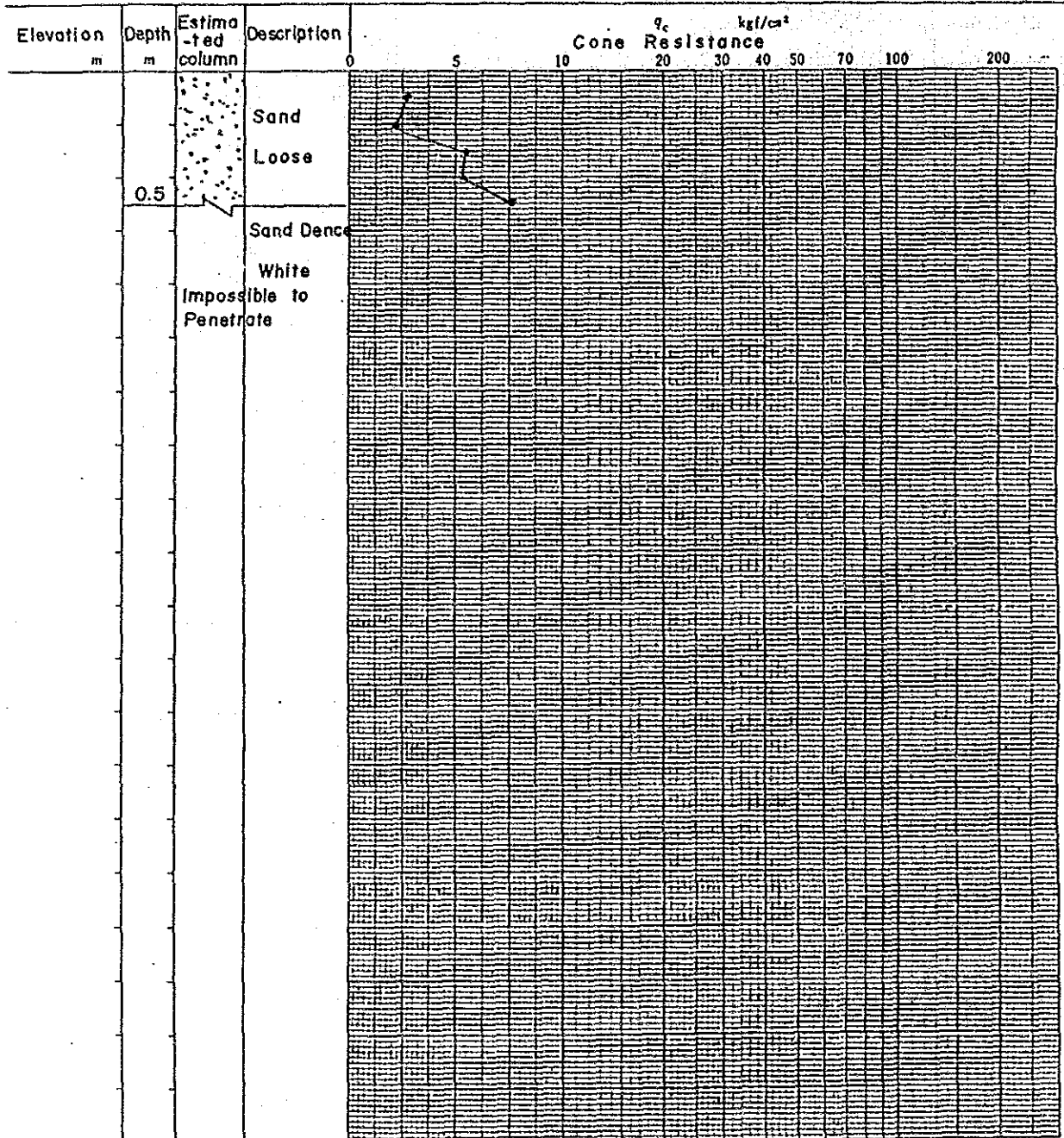

Legend

	Gravel		Clay	
	Sand		Peat	

Annex 5-16 Tower Foundation Type 1

UNIT: mm

SCALE 1/50

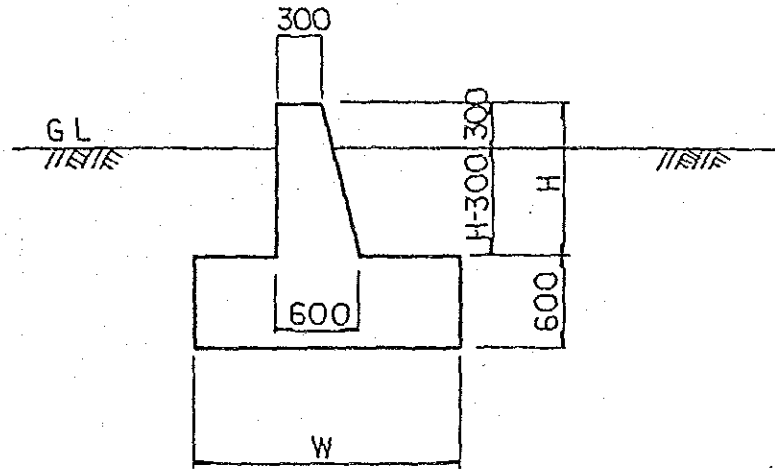

Dimension	TOWER TYPE		
	B	K	D
W	1800	2600	3400
H	1000	1800	2400

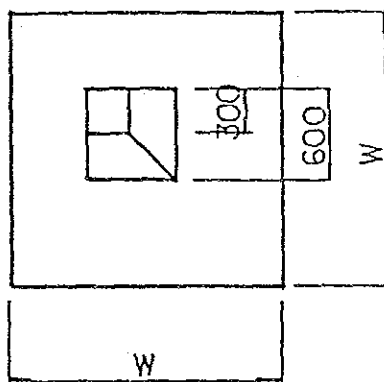

UNIT: mm

SCALE 1/100

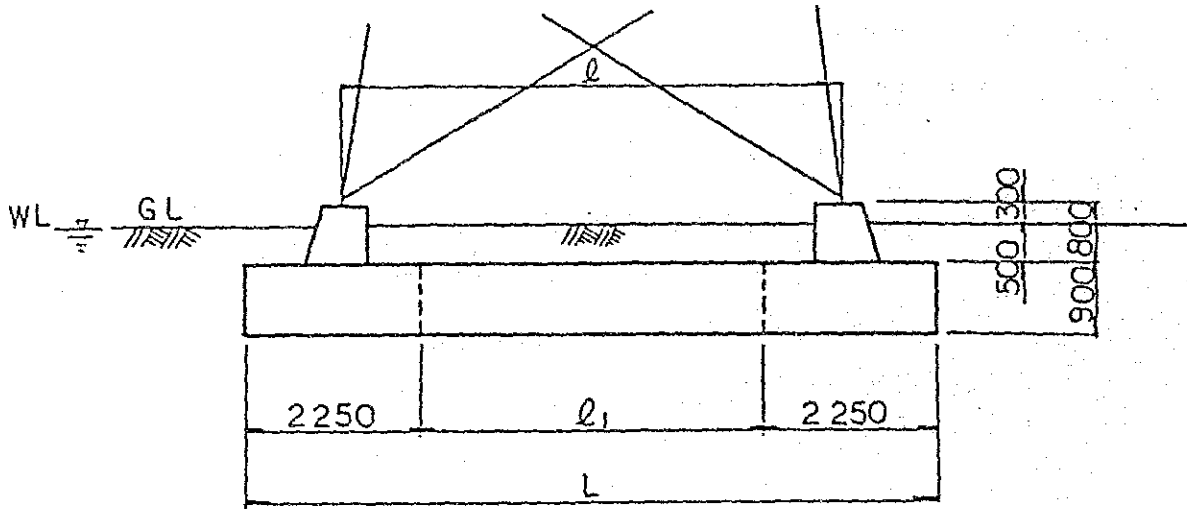

Dimension	TOWER TYPE		
	B	K	D
L	9000	10600	13000
l_1	4500	0	0
l	6500	7000	7000

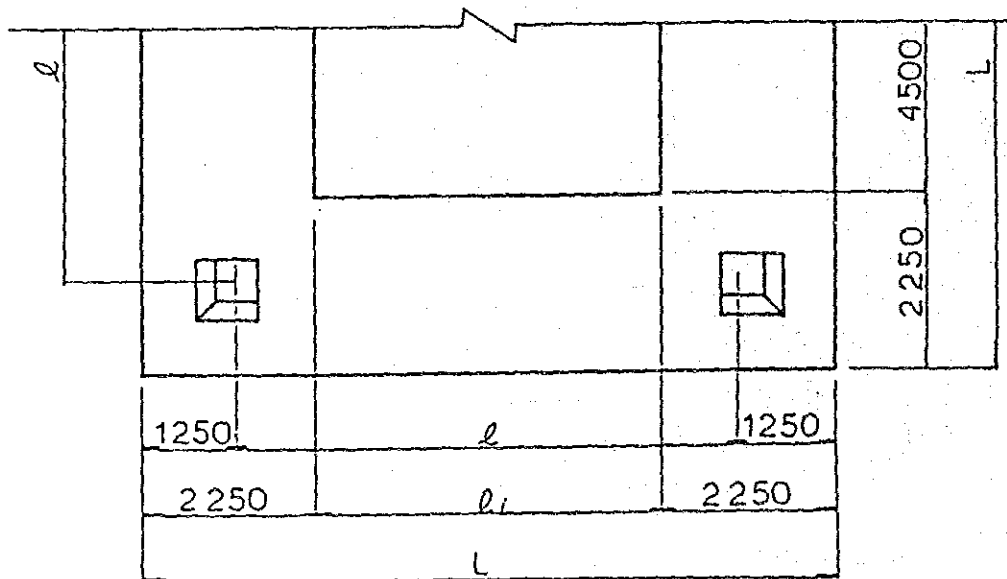

UNIT: mm

SCALE 1/100

corresponding tower type
 B Type ← → K, D Type

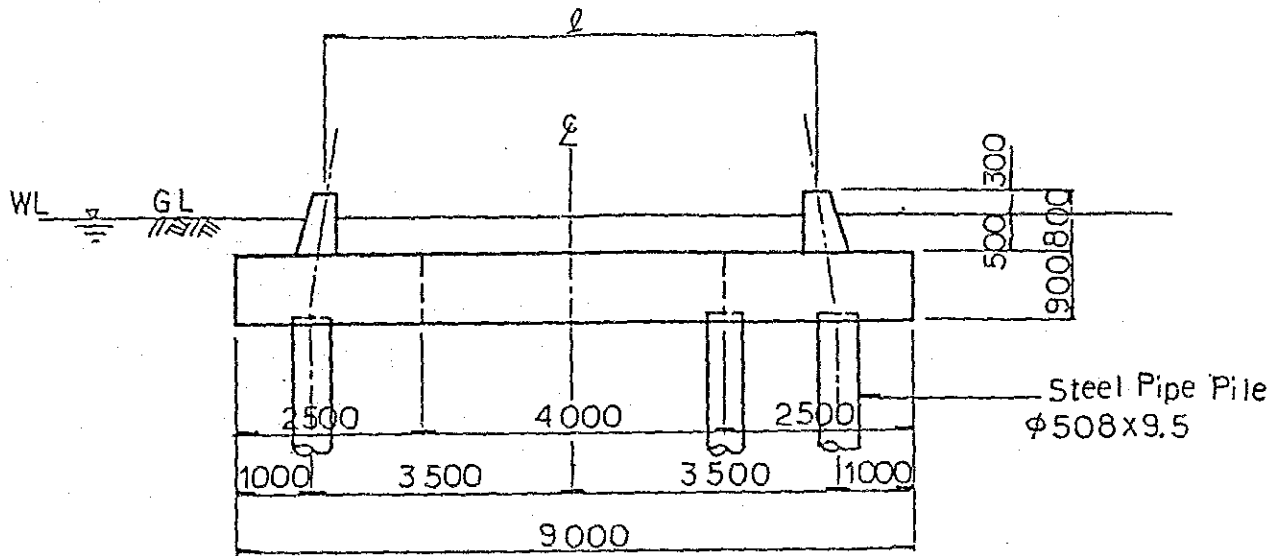

	TOWER TYPE		
	B	K	D
Pile No.	1	2, 3	1, 2, 3
Number (Piles/Tower)	4	8	12
l	6500	7000	7000

Symmetry

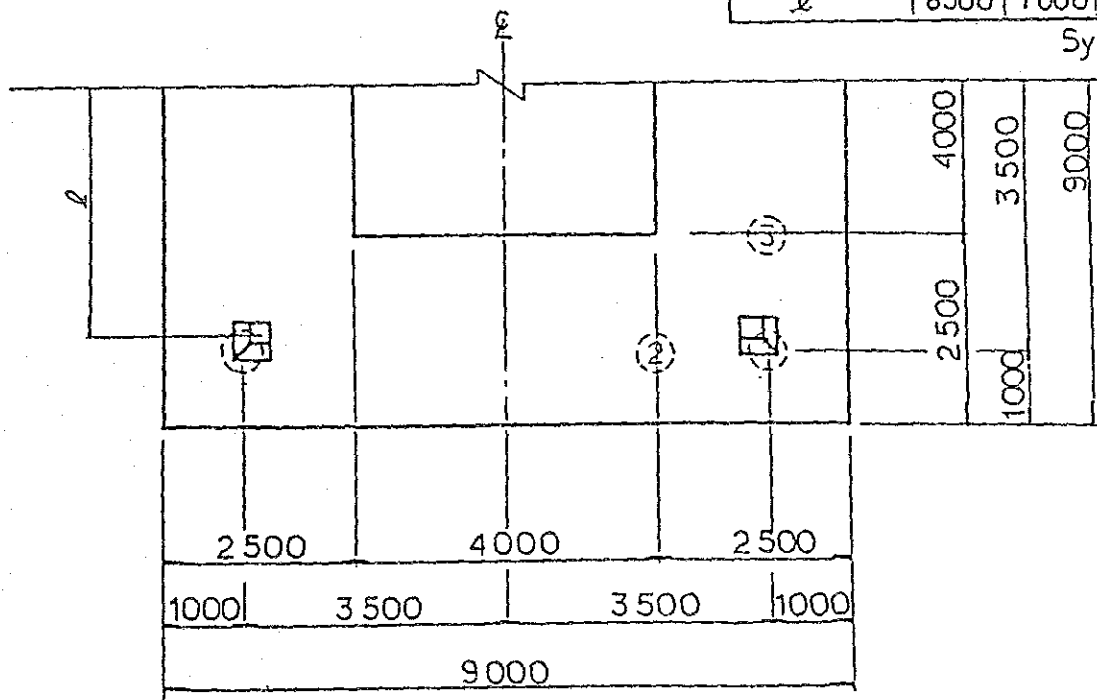

ARRANGEMENT OF SUBSTATION

-THIS LAYOUT IS INDICATED TO NEW SUBSTATION ON THE EXISTING EQUIPMENTS.

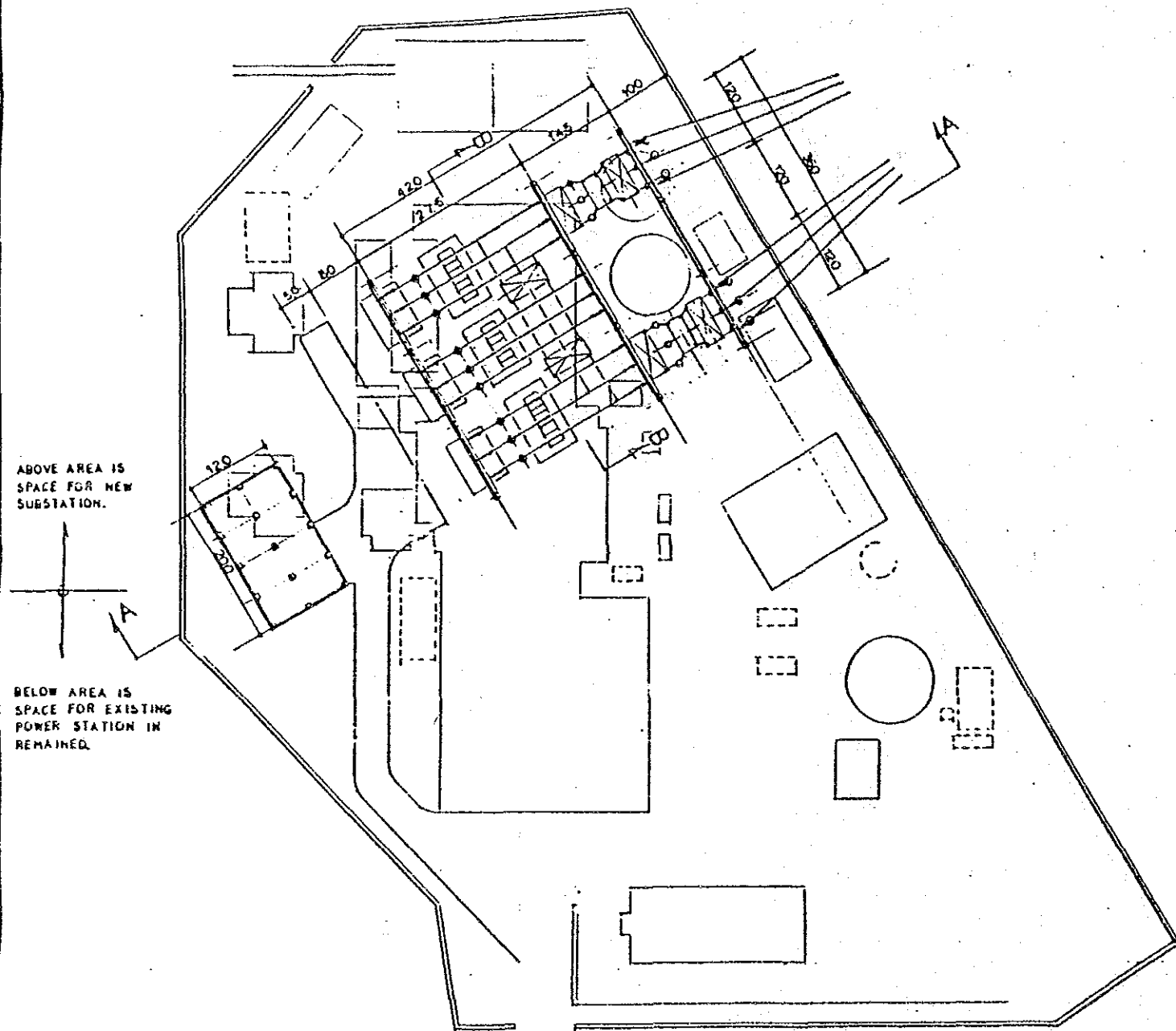

ABOVE AREA IS SPACE FOR NEW SUBSTATION.

BELOW AREA IS SPACE FOR EXISTING POWER STATION IN REMAINED.

CONNECTION DIAGRAM

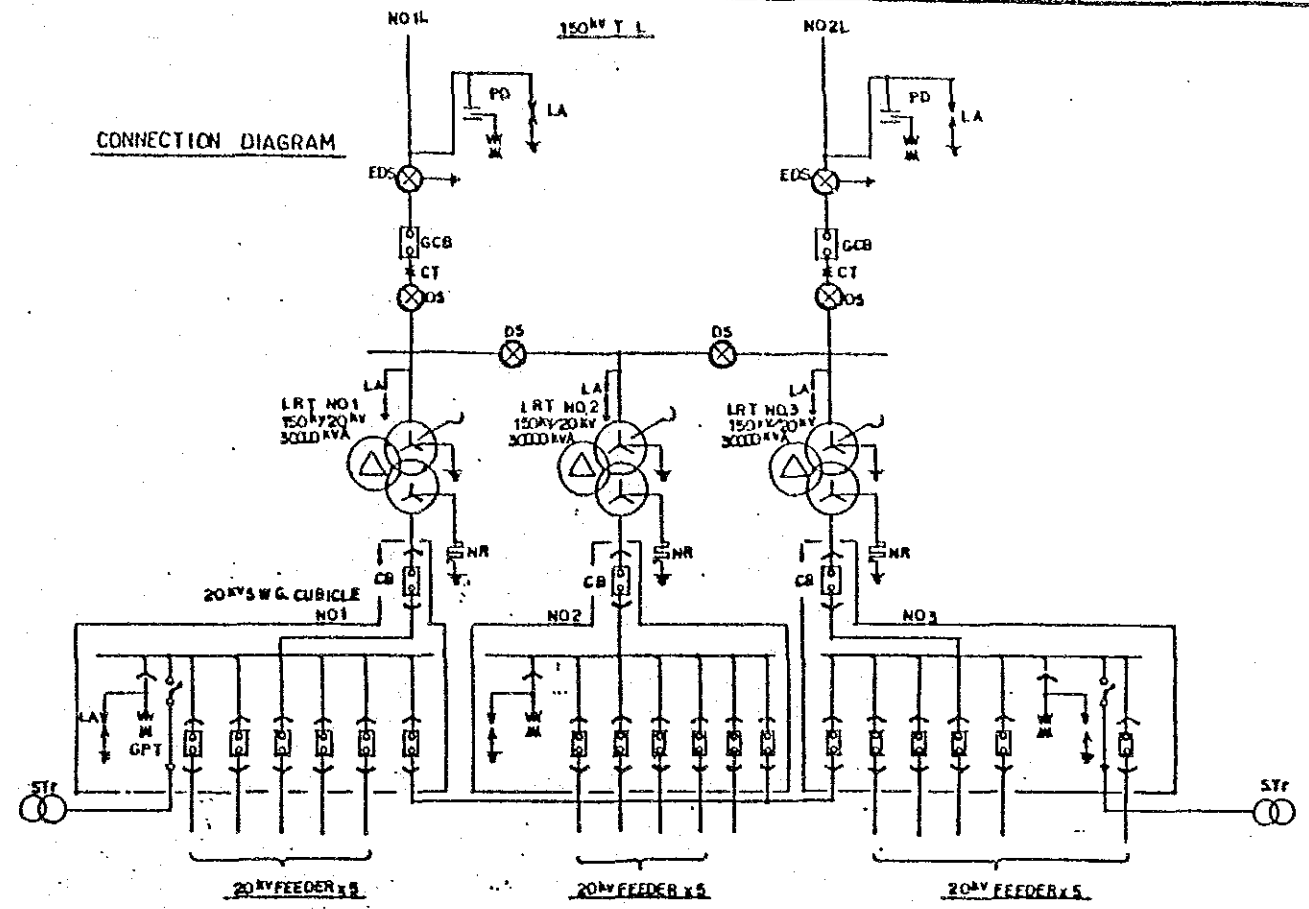

DETAILS OF B-B BUS SECTION

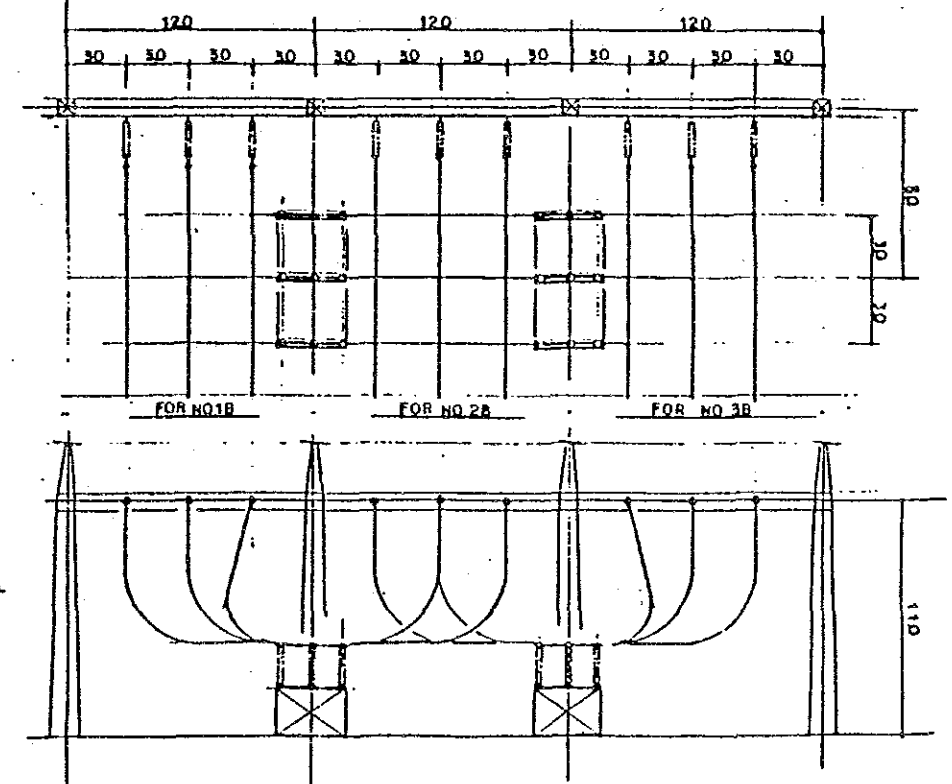

DETAILS OF A-A SECTION

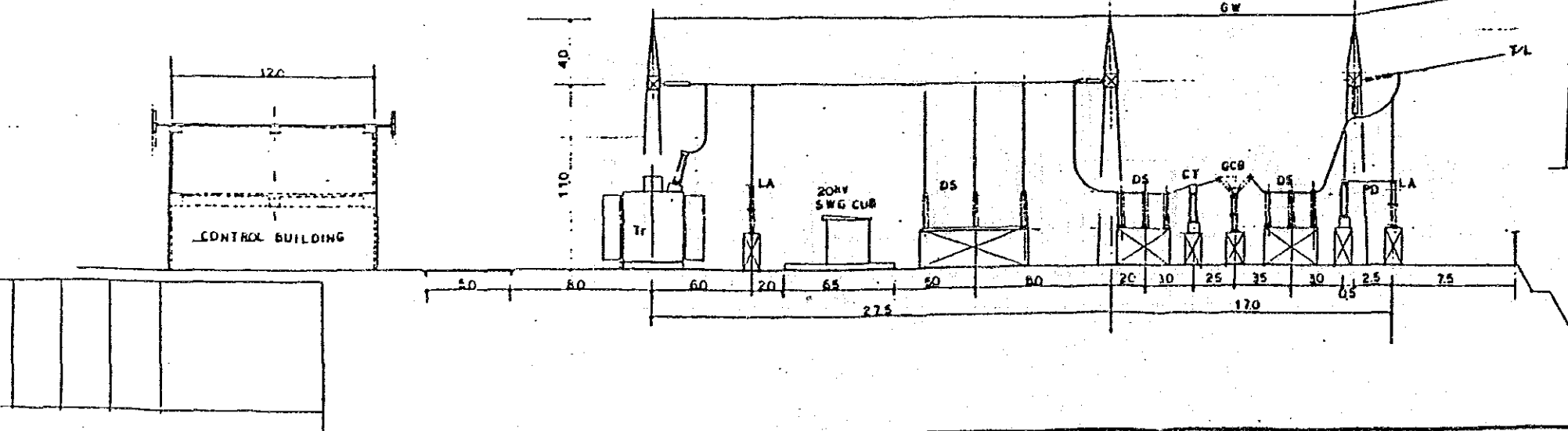

Annex 6-1 (a) Arrangement and Connection Diagram for Simpang baru S/S-1

55
44

ARRANGEMENT OF SUBSTATION

THIS LAYOUT IS INDICATED TO NEW SUBSTATION ON THE EXISTING EQUIPMENT.

ABOVE AREA IS SPACE FOR NEW SUBSTATION.

BELOW AREA IS SPACE FOR EXISTING POWER STATION IN REMAINED.

CONNECTION DIAGRAM

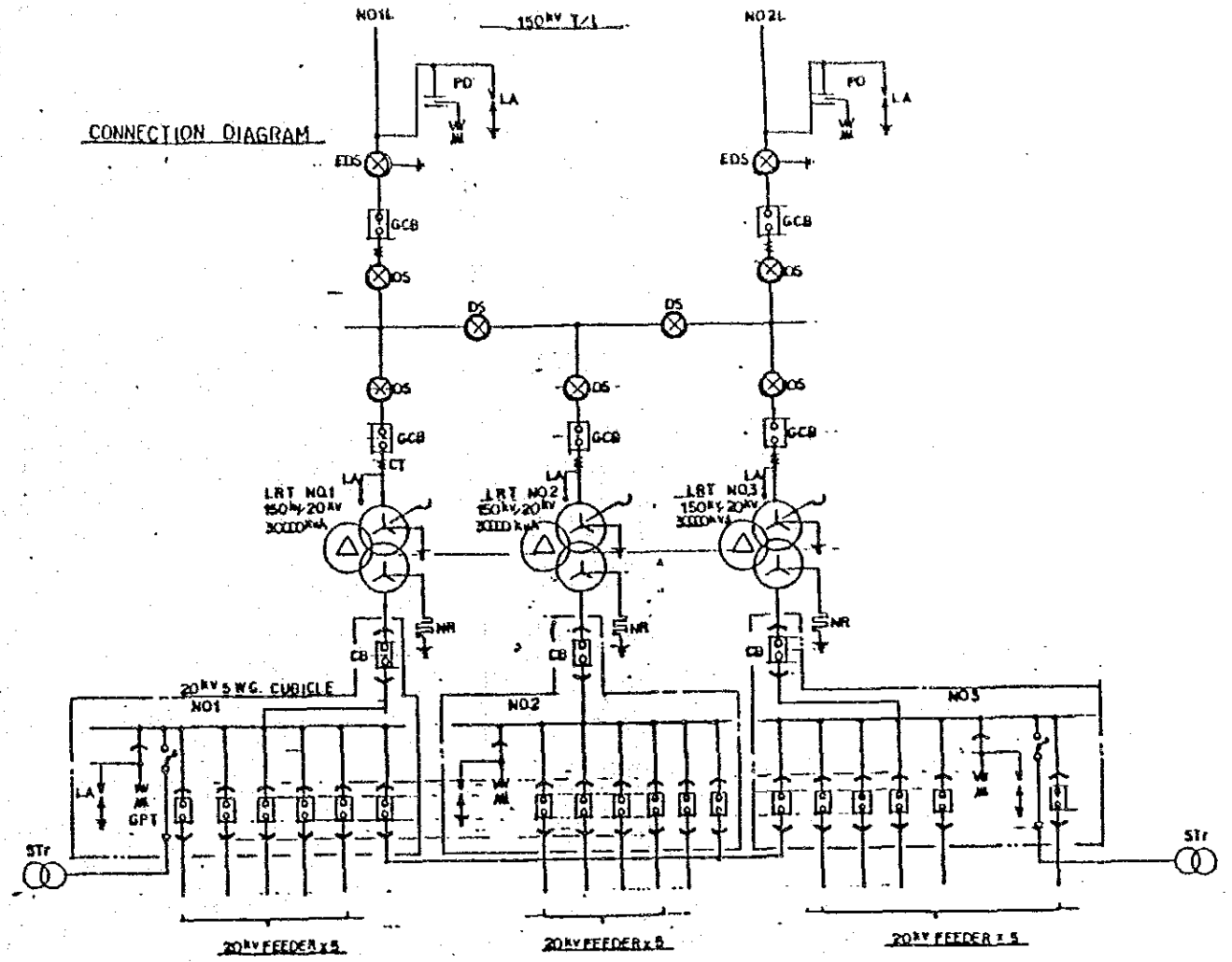

DETAILS OF 150KV BUSBAR

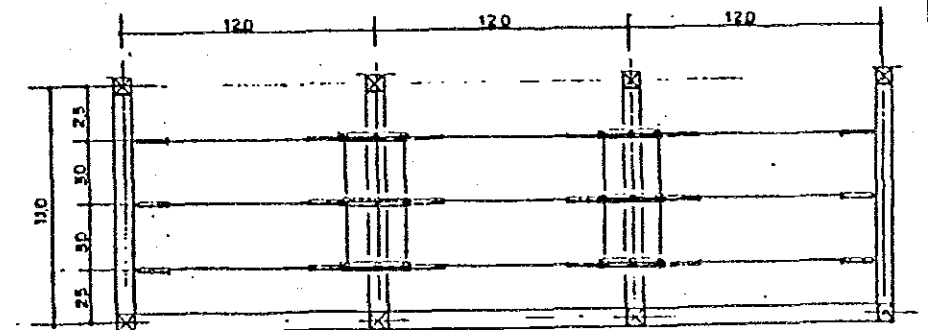

DETAILS OF A-A SECTION

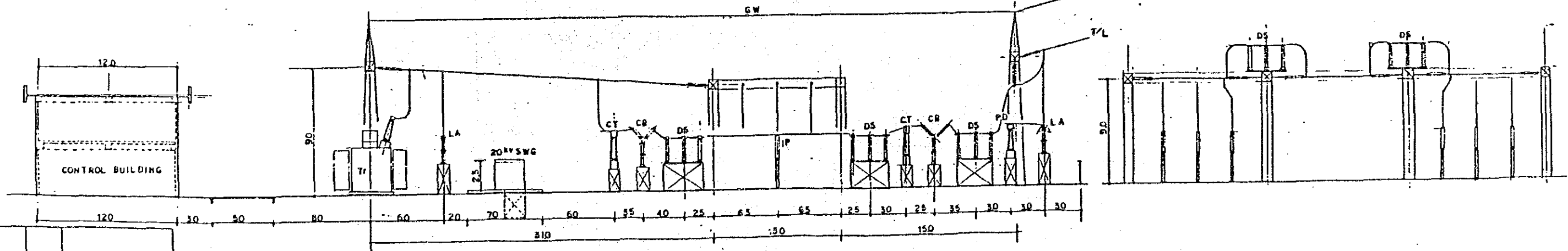

Annex 6-1 (B) Arrangement and Connection Diagram for Simpang baru S/S-2

56
45

CONNECTION DIAGRAM

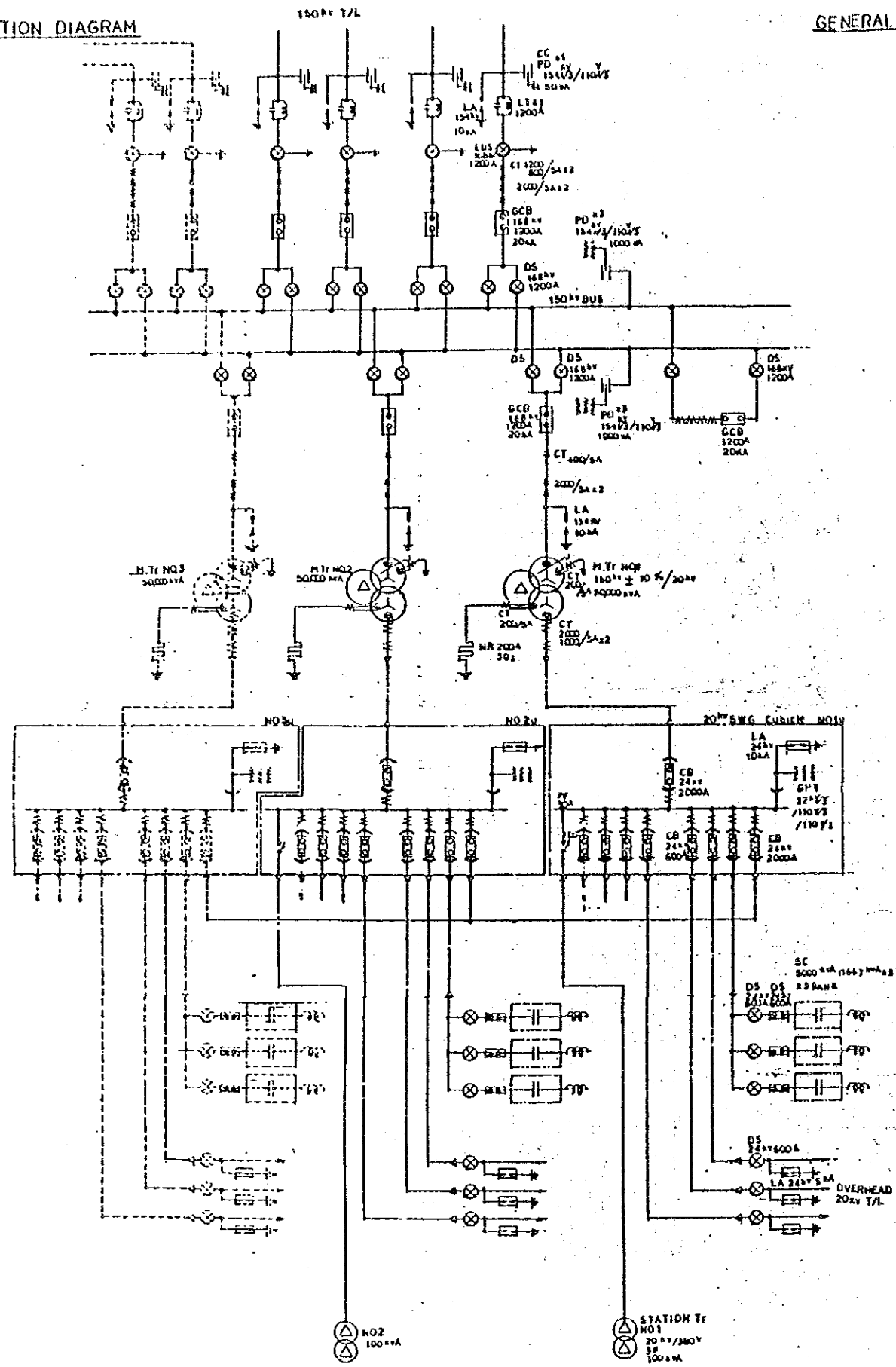

NOTE -
RATING OF EQUIPMENTS FOR BLANK
ARE SAME AS RIGHT.

GENERAL LAYOUT

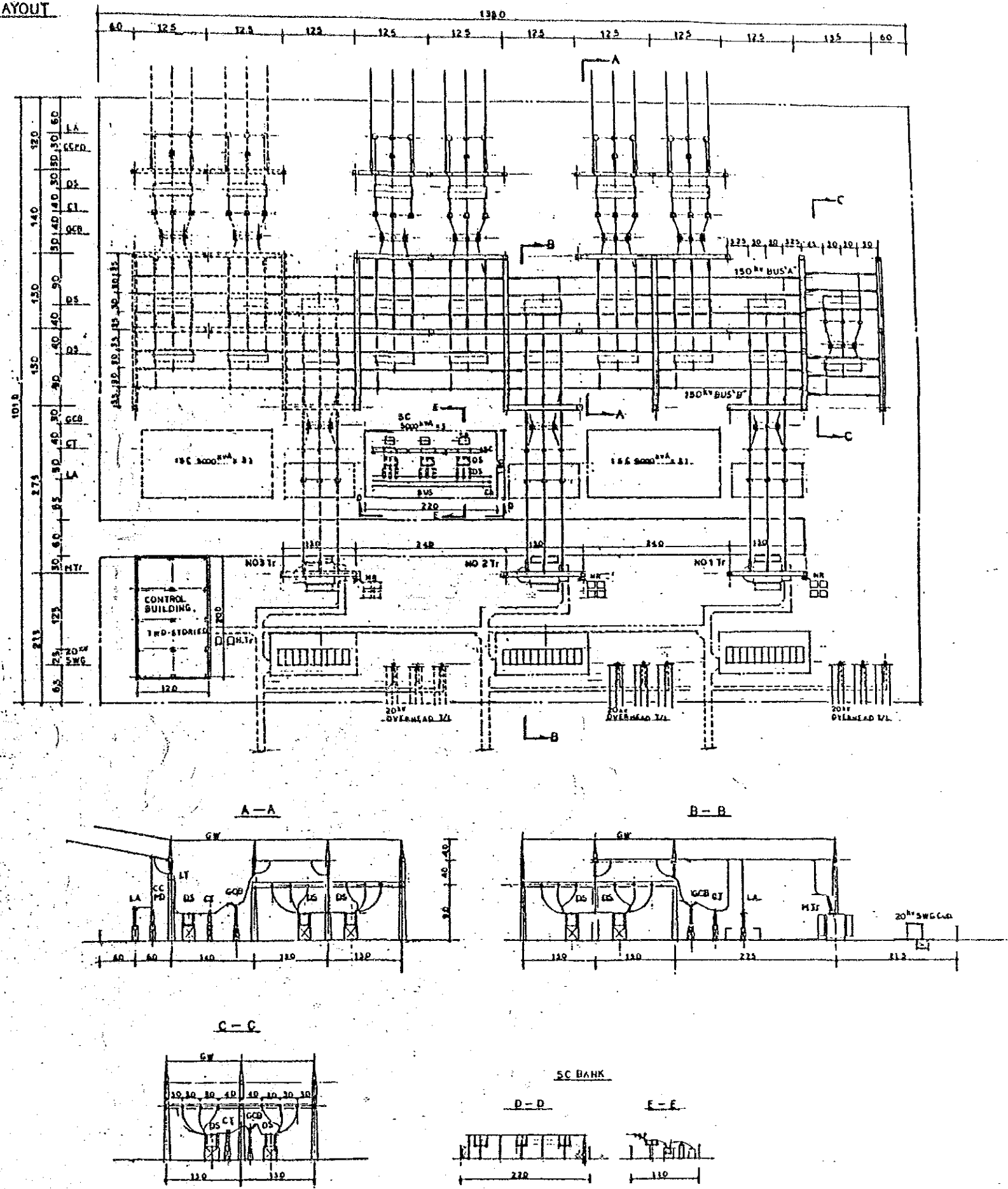

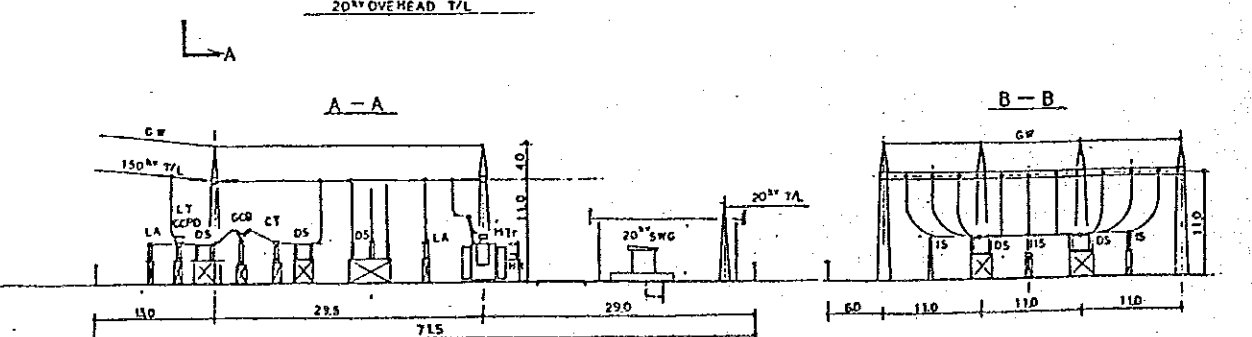
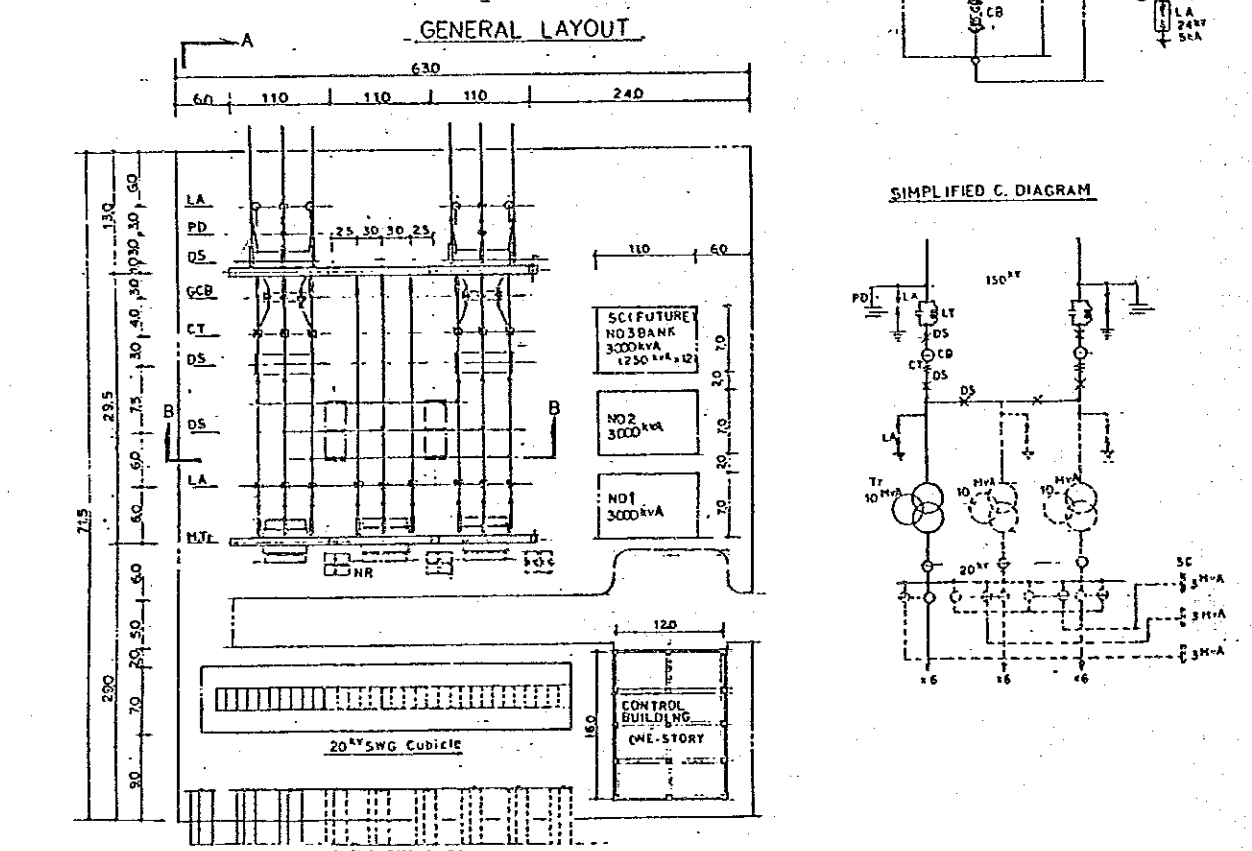
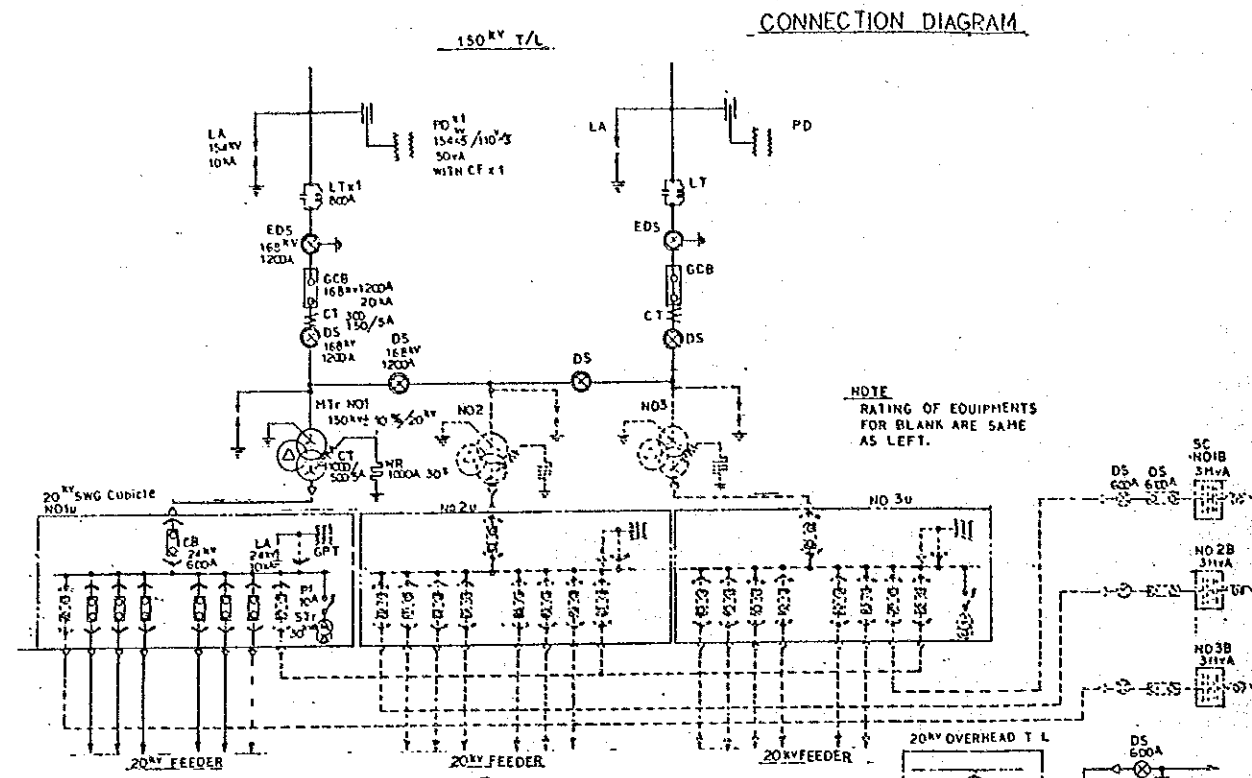

Annex 6-3 Typical Layout for 150/20 kV, 10 MVA x3 Substation

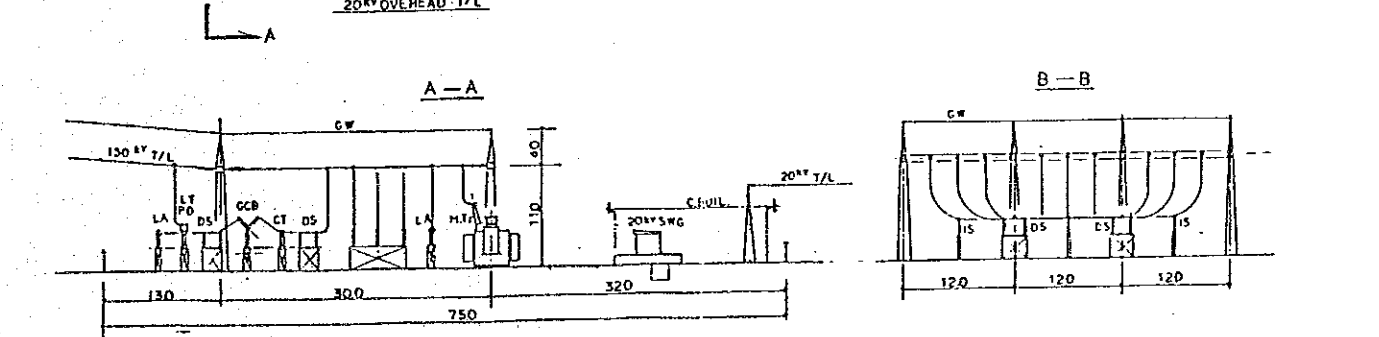
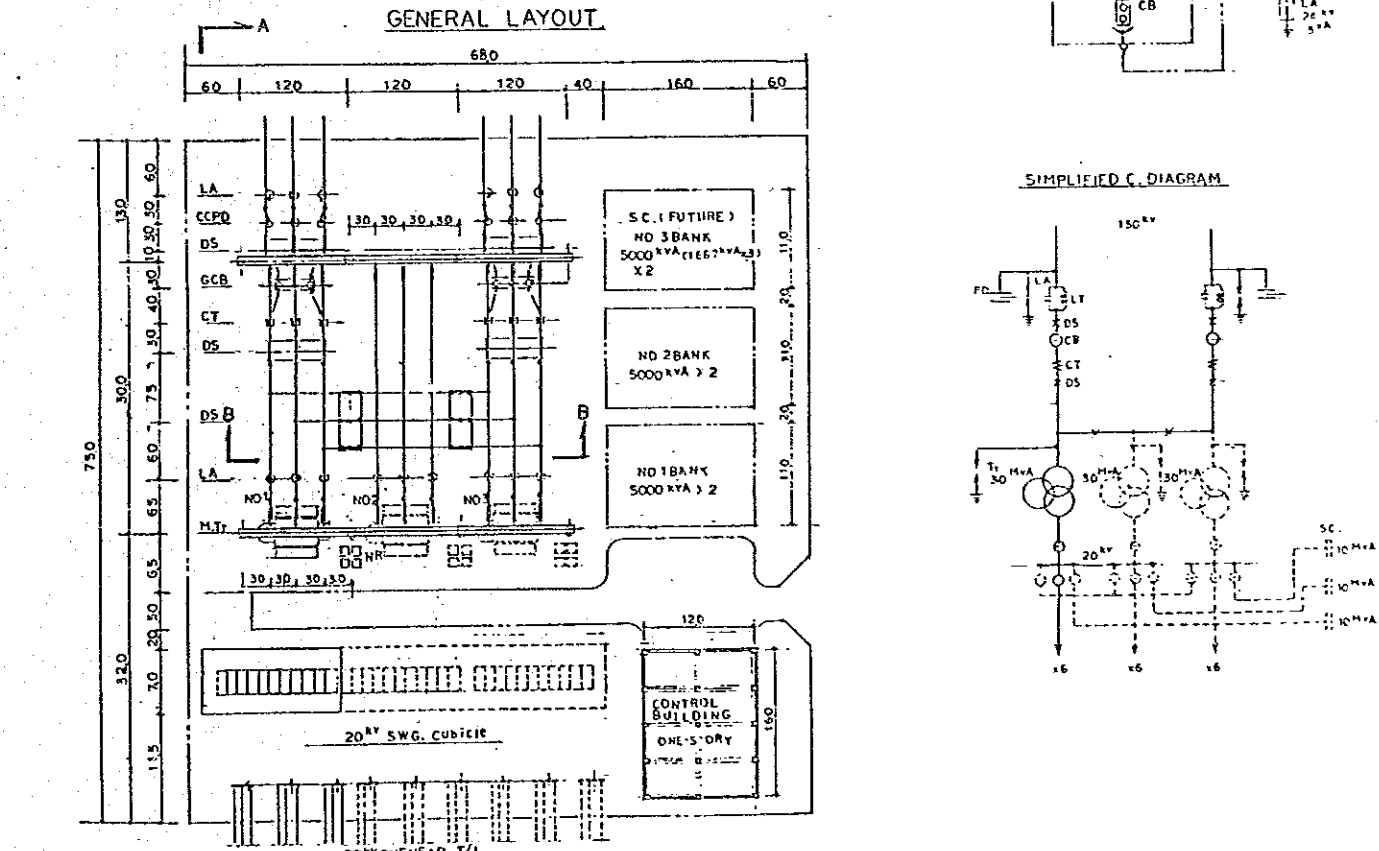
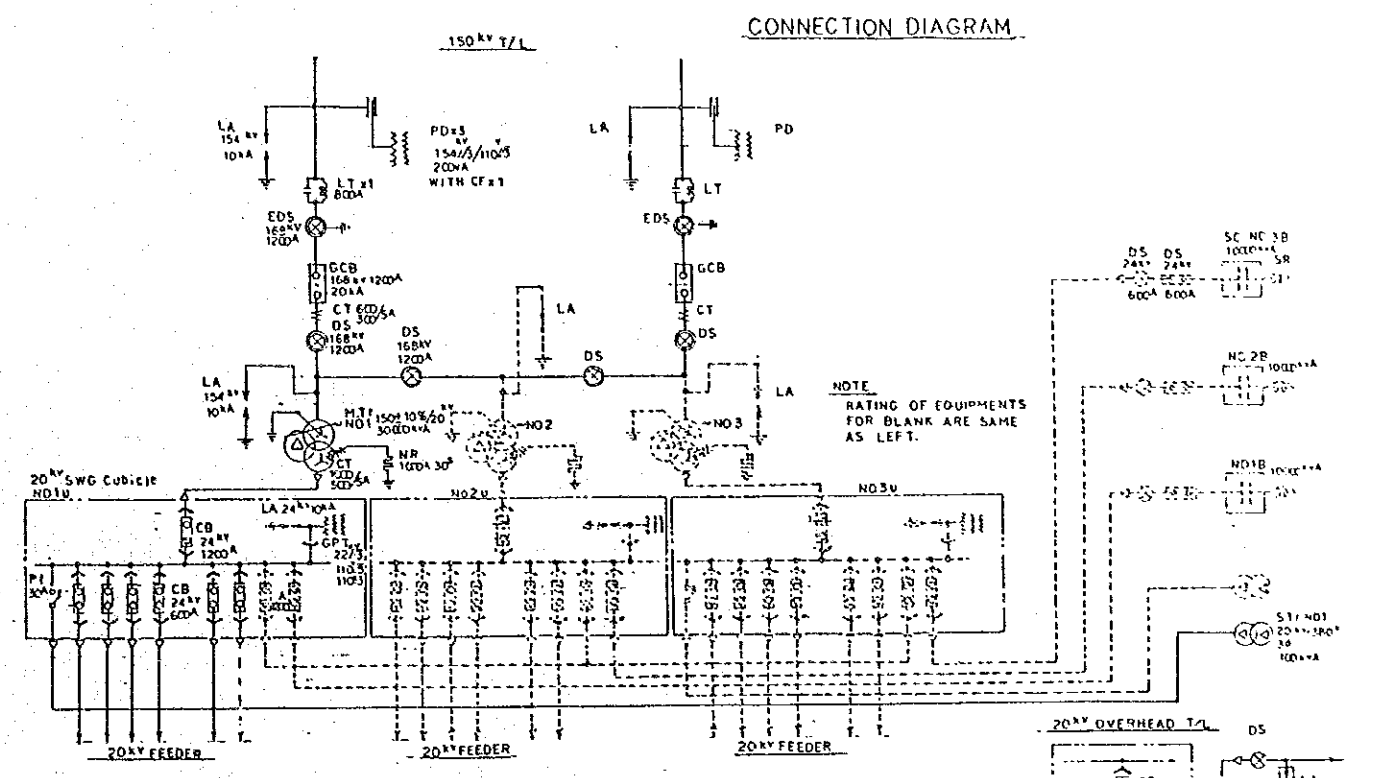

Annex 6-4 Typical Layout for 150/20 kV, 30 MVA x3 Substation

Comparison of Power Loss in 20 kV Distribution Line and 150 kV Transmission Line

(20 MW is assumed to be transmitted over a distance of 7 km)

- a. In case electric power is transmitted at 150 kV by introducing a 150 kV line to Simpangharu Substation

When 240 mm², 2 circuit line is used in parallel,

$$R = 0.1296/2 = 0.0648$$

$$\text{kW loss} = (20,000/150/0.9)^2 \times 0.0648 \times 7 = 9.956 \text{ kW} \doteq 10 \text{ kW}$$

$$\text{kWh loss} = 9.956 \times 8,760 \times 0.432 = 37,675 \text{ kWh} \doteq 38 \text{ MWh}$$

- b. In case electric power is transmitted from Pauh Limo Substation by combinedly using 20 kV 4 circuit distribution lines

In case of 240 mm², 4 circuits,

$$R = 0.0324$$

$$\text{kW loss} = (20,000/20/0.9)^2 \times 0.0324 \times 7 \doteq 280 \text{ kW}$$

$$\text{kWh loss} = 280 \times 8,760 \times 0.432 = 1,059,610 \text{ kWh} \doteq 1,060 \text{ MWh}$$

- c. Difference between both cases in terms of money amount

270 kW	1,022 MWh
In terms of ¥5,800/kW/year	¥1,566 x 10
¥8.7/kWh	¥8,891 x 10
Total	¥10,457 x 10

The present value in case transmission through 150 kV line is assumed to have continued for three years,

$$10,457 \times \left(1 + \frac{1}{1.12} + \frac{1}{1.12^2} \right) = 10,457 \times 2.69 = 28,129$$

Therefore, power transmission through 150 kV transmission line is advantageous over 20 kV distribution line by about ¥28 million in terms of the amount of reduced power loss.

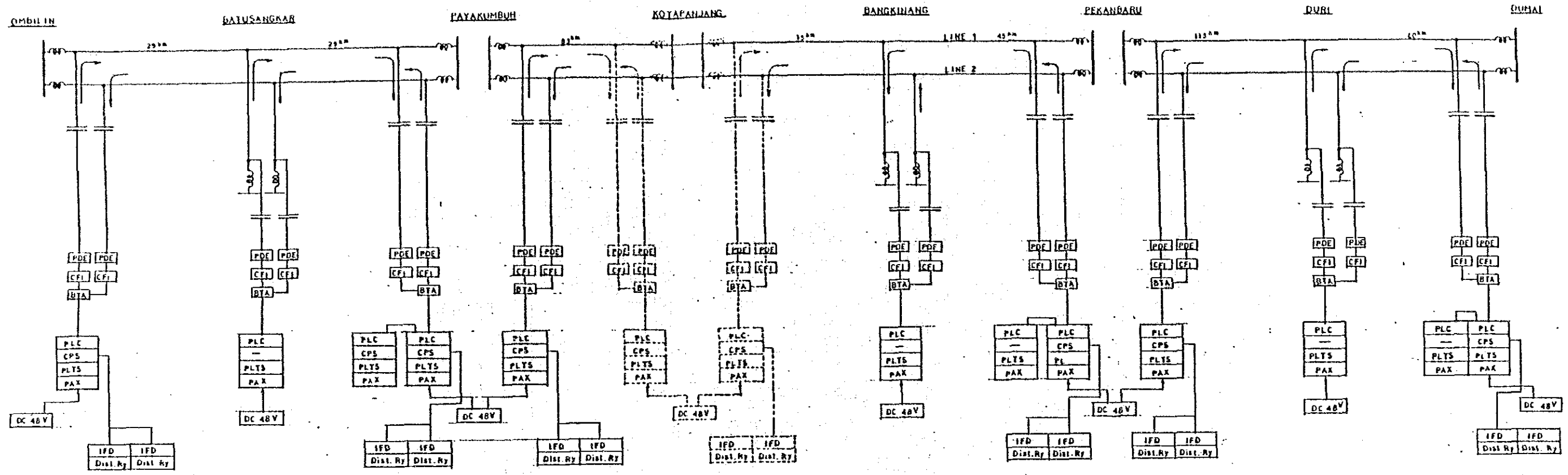

- LEGEND**
- WAVE TRAP
 - CAPACITIVE VOLTAGE TRANSFORMER
 - BTA** BALANCING TRANSFORMER
 - CFI** COUPLING FILTER
 - CPS** 2-CHANNEL PROTECTION SIGNALLING
 - IFD** INTERFACE DEVICE
 - PAX** PRIVATE AUTOMATIC EXCHANGE
 - PDE** PROTECTION DEVICE
 - PLC** 3-CHANNEL POWER LINE CARRIER

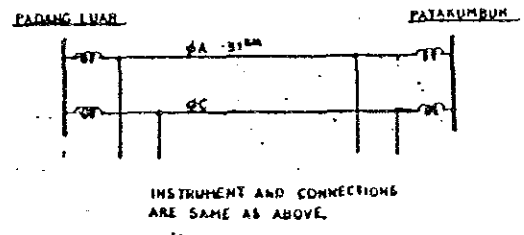

APPLICABLE SECTION

PALIHILIMO S.S. 7 KM SEMPANG HARU S.S.
 DUMAI S.S. 10 KM PERTAMINA S.S.

150kV T/L

GENERAL CONNECTION FOR PILOT WIRE SYSTEM

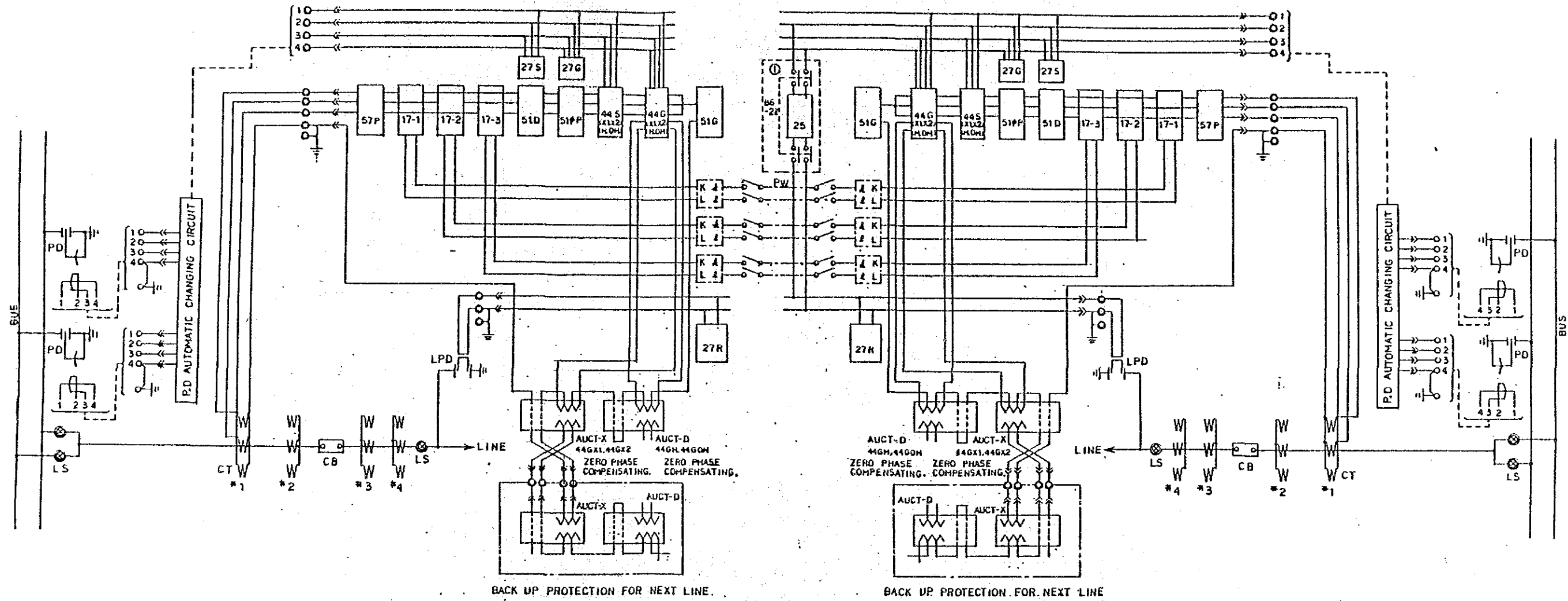

NOTICE

① 25 IS PUT IN THE SUBSEQUENT TRIP SIDE CIRCUIT. (THE DRAWING SHOWS FOR B PHASE)

② IN CASE STATIC RELAY CIRCUIT, A SURGE-ABSORPTION CIRCUIT IS PROVIDED.

57P	OVER CURRENT RELAY	DETECT POWER FLOW FOR RE-CLOSE			
17-1	PILOT WIRE RELAY	DETECT INTERNAL FAULT	44S	DISTANCE RELAY	DETECT SHORT FAULT INTERNAL DERECTION
17-2			44G	DISTANCE RELAY	DETECT GROUND FAULT INTERNAL DERECTION
17-3			51G	OVER CURRENT GROUND RELAY	DETECT GROUND FAULT (COMBINED TO 44G)
27S	UNDER VOLTAGE RELAY	DETECT SHORT FAULT (COMBINED TO 17)	27R	UNDER VOLTAGE RELAY	CONFIRM LINE VOLTAGE
27G	UNDER VOLTAGE RELAY	DETECT GROUND FAULT (COMBINED TO 17)	25	SYNCHRONIZING RELAY	CONFIRM SYNCHRONIZE
51D	OVER CURRENT RELAY	DETECT SHORT FAULT (COMBINED TO 44S)	86-2Z	AUXILIARY RELAY	START SYNCHRONIZING RELAY
51PP	OVER CURRENT RELAY	DETECT OPEN PHASE OF LINE (COMMON SHORT FAULT AND GROUND FAULT)			
DEV. NO.	NAME OF RELAY	USEFULNESS	DEV. NO.	NAME OF RELAY	USEFULNESS

Annex 6-7 Recommendatory Protection System for Short Distance T/L

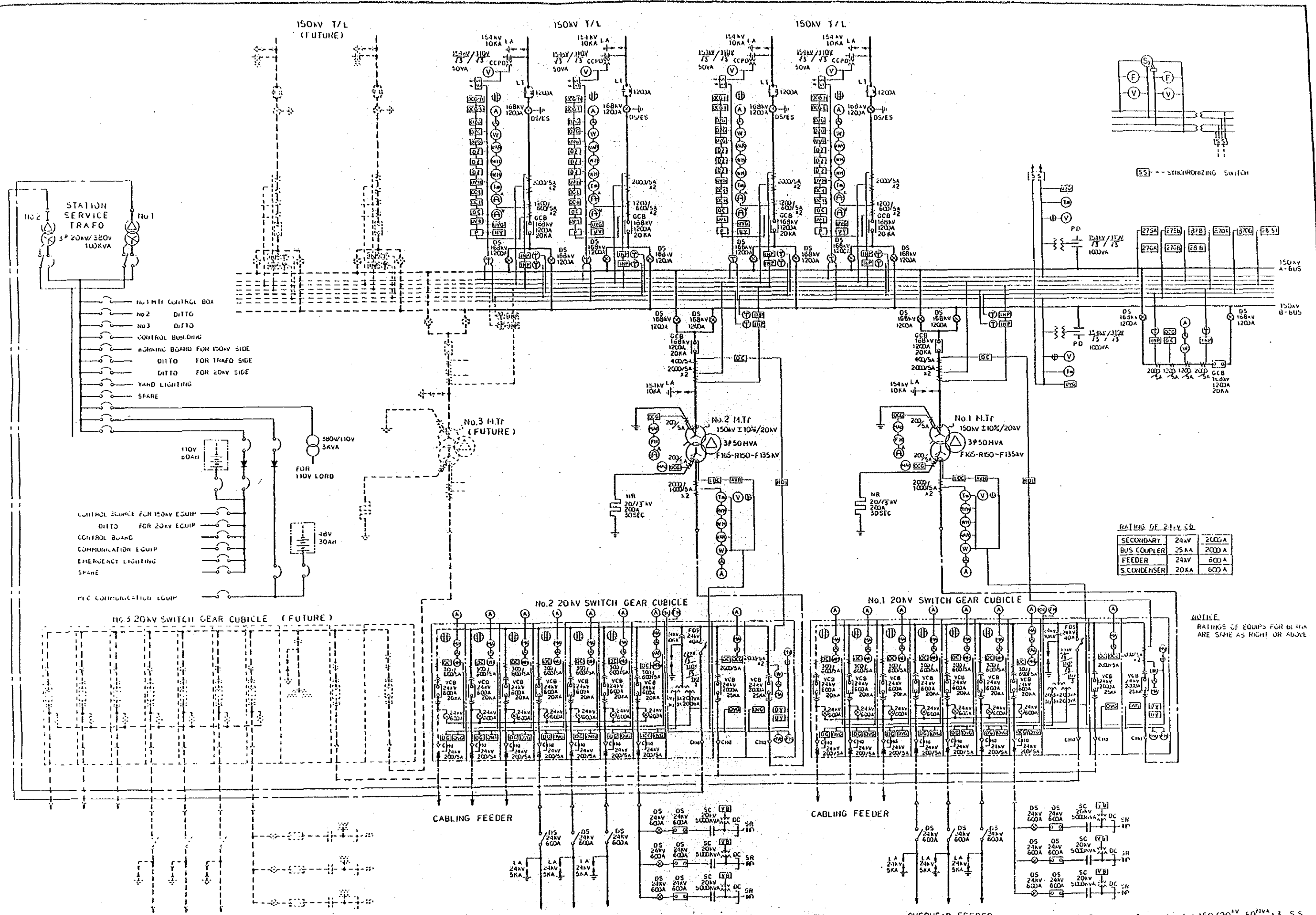

RATINGS OF 24V SCB

SECONDARY	24V	2000A
BUS COUPLER	25kA	2000A
FEEDER	24kV	600A
CONDENSER	20kA	600A

NOTE:
RATINGS OF EQUIPS FOR BE BUS ARE SAME AS RIGHT OR ABOVE.

Annex 6-B Typical Connection for 150/20kV, 50MVA x 3 S.S.

Annex 6-9(a) System Frequency Variation by Load Shedding-Case 1

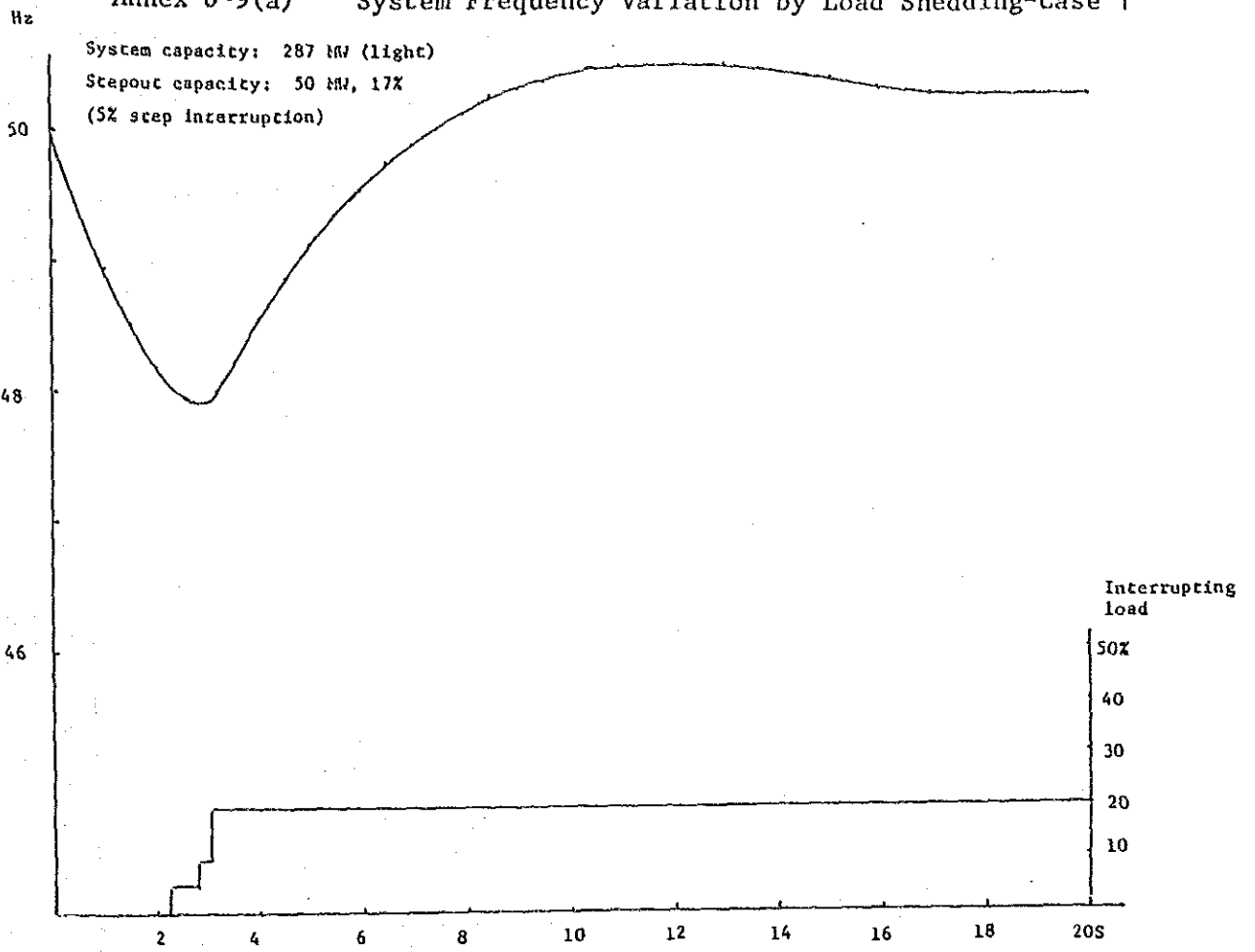

Annex 6-9(b) System Frequency Variation by Load Shedding-Case 2

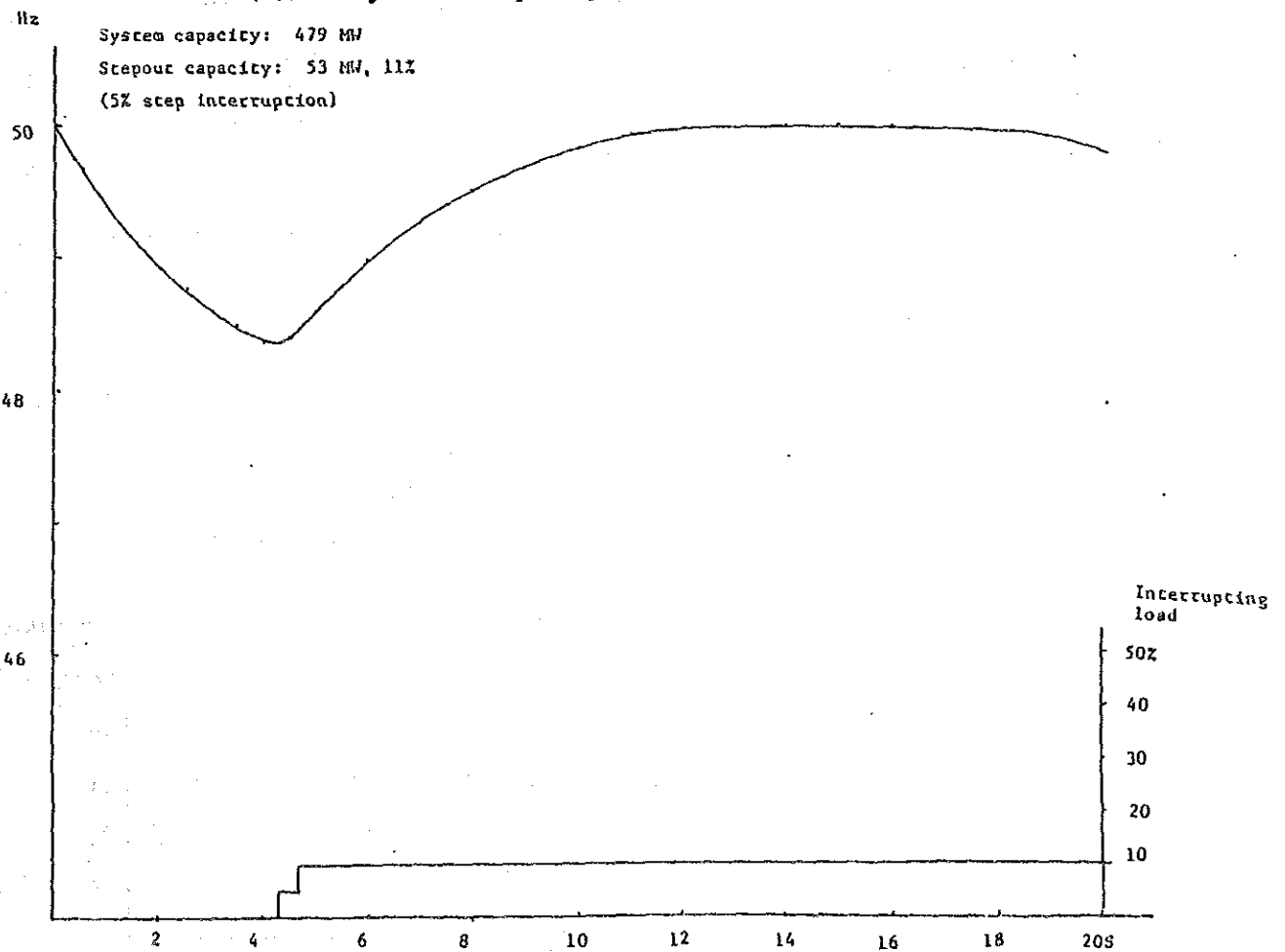

Annex 6-9(c) System Frequency Variation by Load Shedding-Case 3

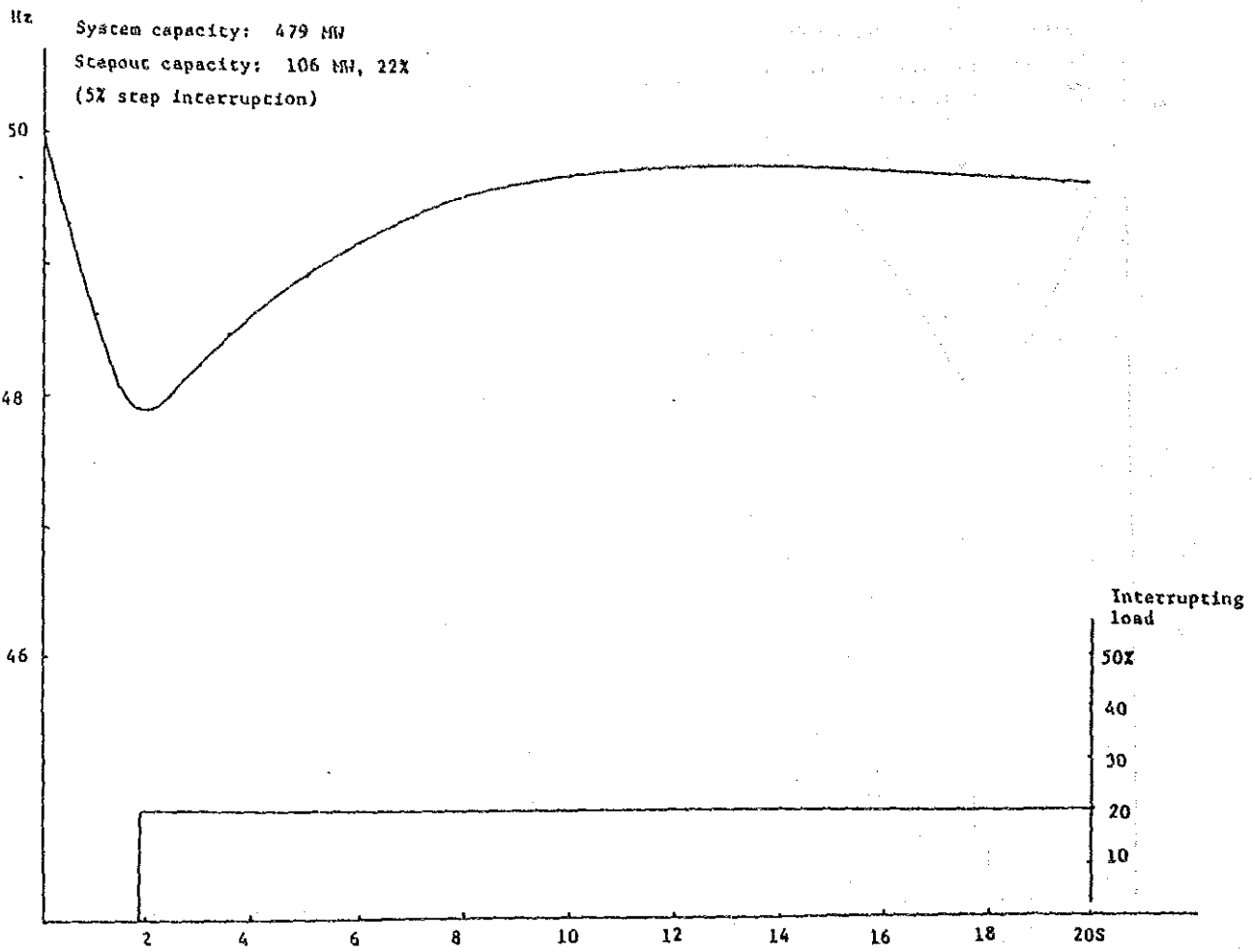

Annex 6-9(d) System Frequency Variation by Load Shedding-Case 4

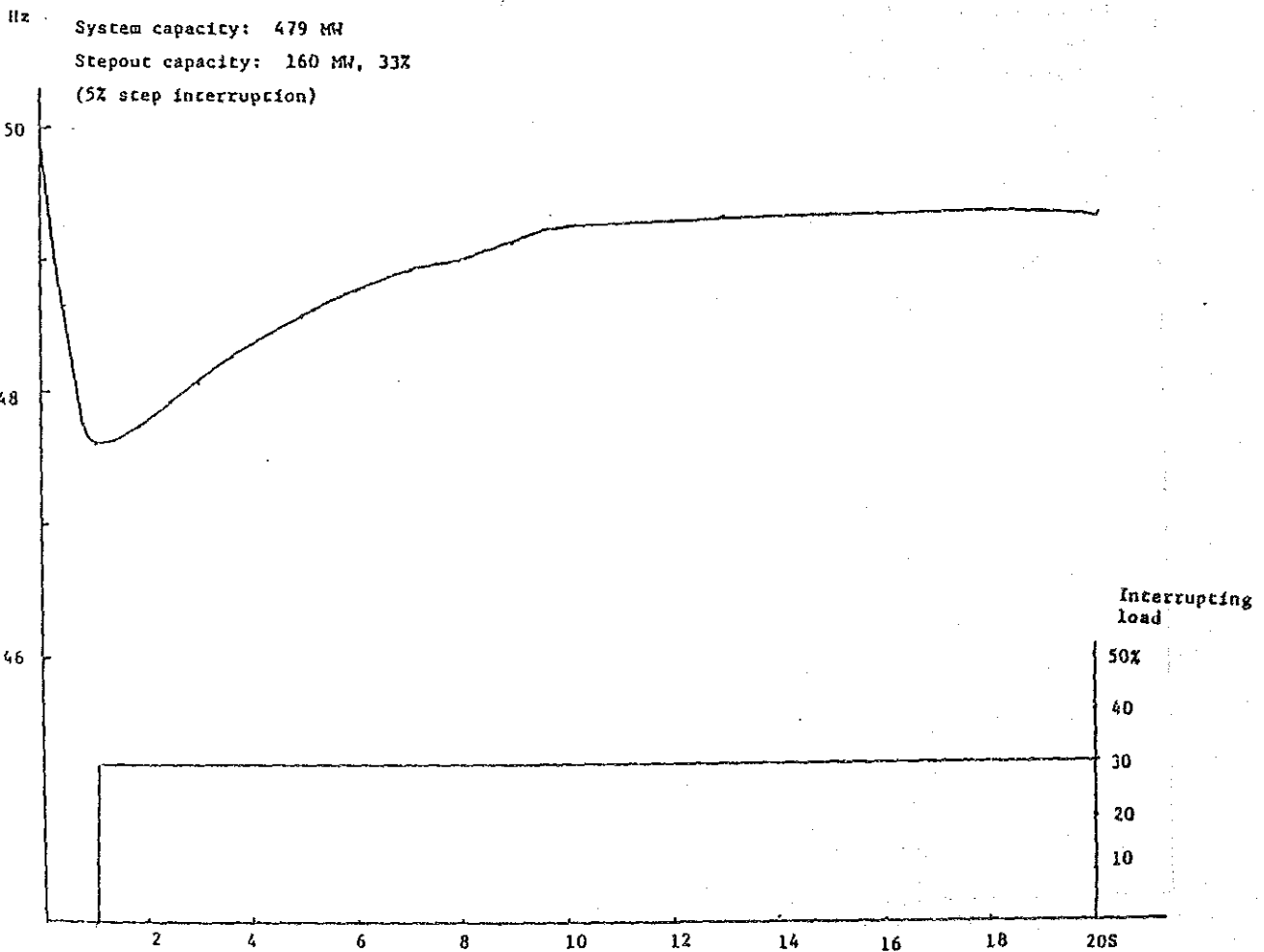

Annex 6-9(e) System Frequency Variation by Load Shedding-Case 5

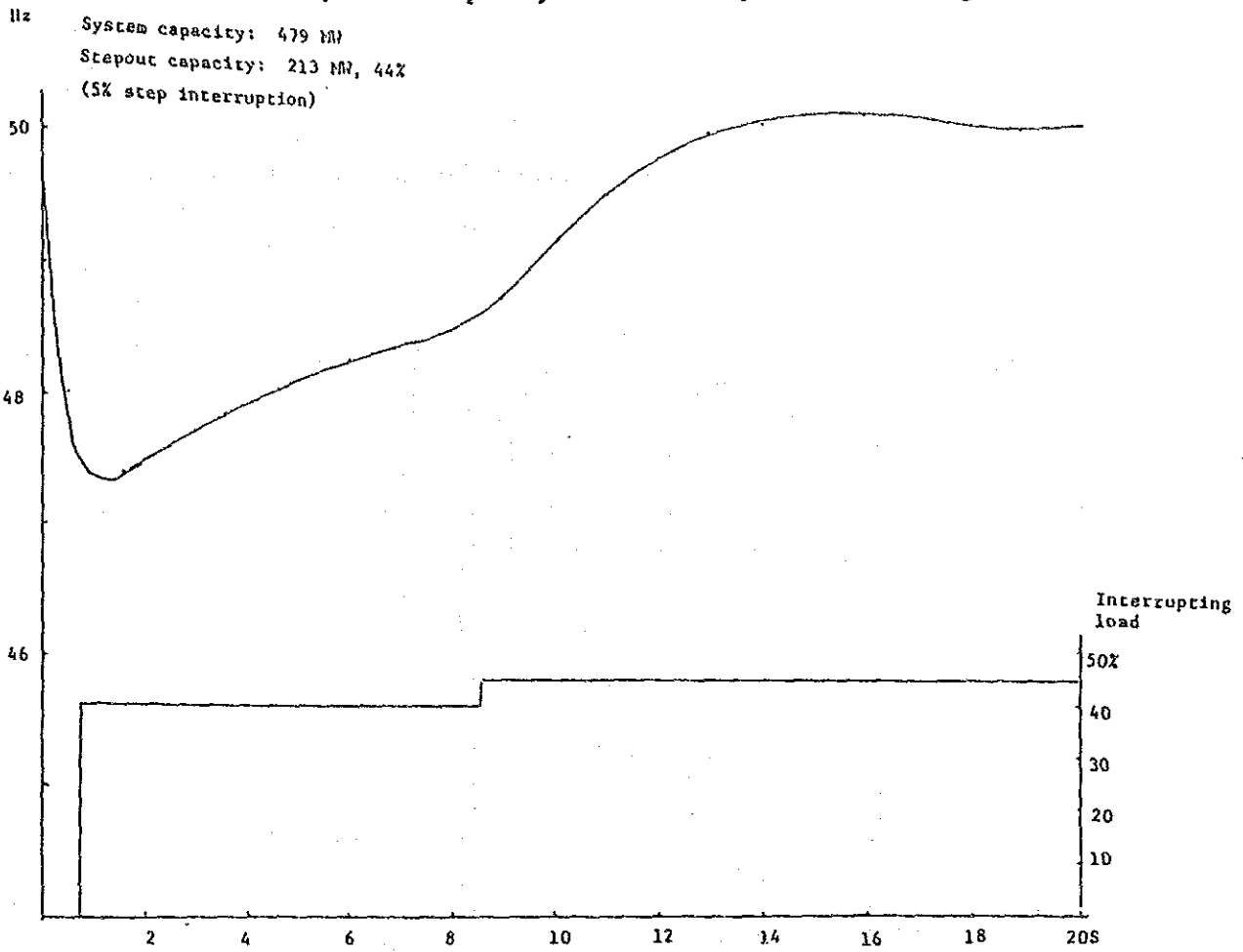

Annex 6-9(f) System Frequency Variation
by Load Shedding-Case 6

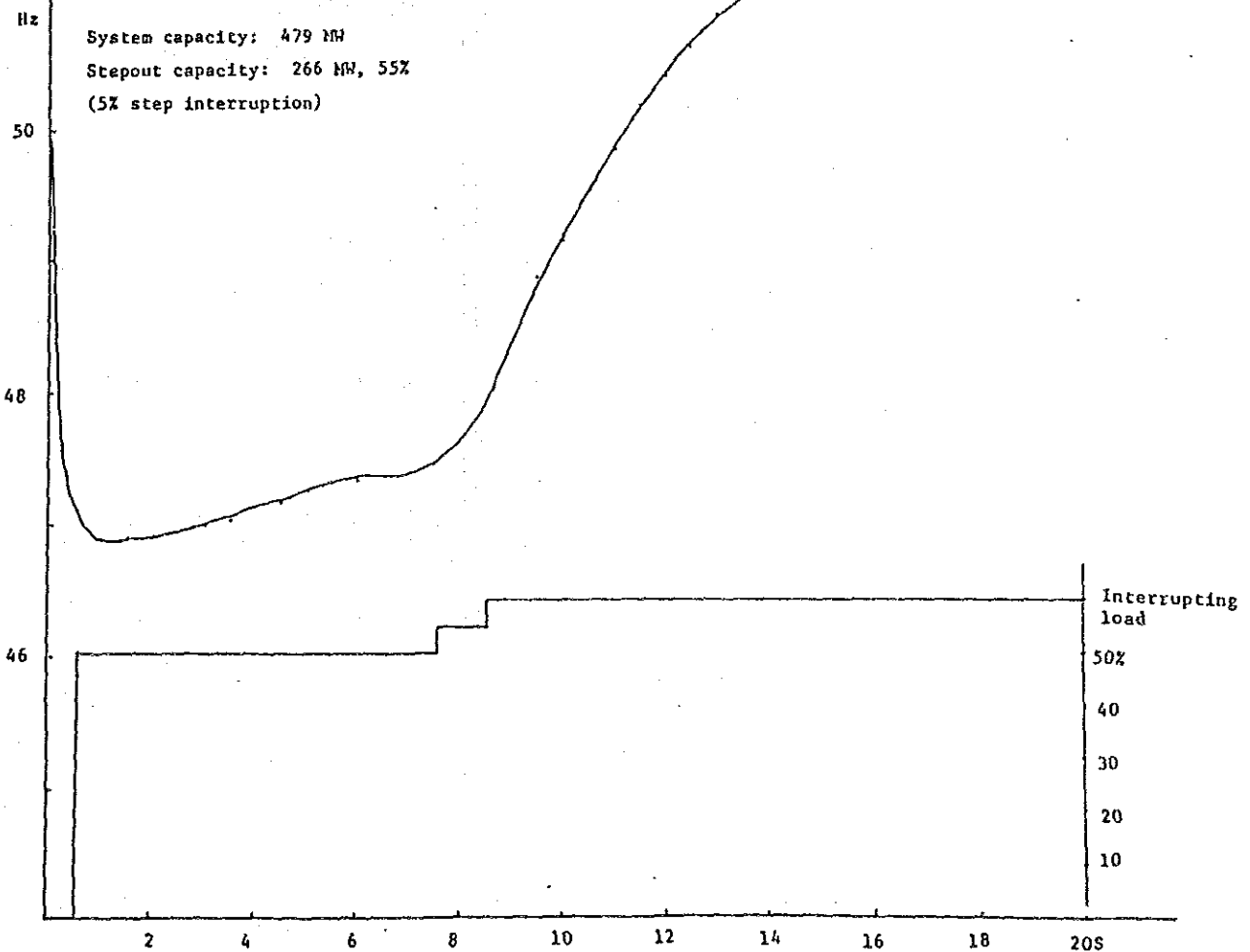

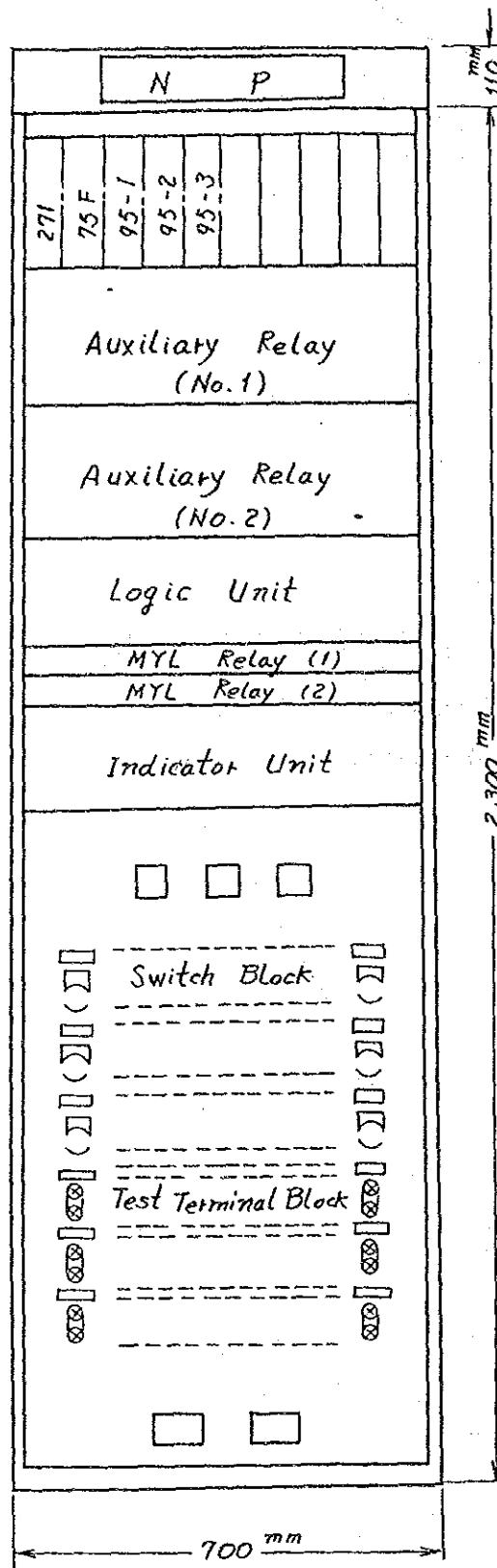

Annex 6-11 Economical Comparison on the Site of Dumai
Substation (Refer to 6.1.1(3))

- (1) As an example of economical comparison on selection of substation site, the study was carried out for Dumai area.

As Dumai Substation construction sites, the following three sites were compared:

	<u>Distance from the central part of the city</u>
A. Site selected under this investigation	10 km
B. Diesel power plant site under planning	18 km
C. Site near the existing diesel power plant	3 km

- (2) Distribution of load density

Considering a general tendency centering the load density to the center parts of the city, the study was implemented on the assumption that 50% of load demand is concentrated in 5% area in Dumai city, and other demand is equally scattered in the whole city area.

To make the study simple, however, the latter is assumed to be concentrated in the end of three directions from the substation site, and the average distance from the substation is supposed as follows.

Site	A	B	C
Average distance in km	5.5	10.8	5.0

(3) Distribution line plan

In the first stage, two circuits for city center and three circuits for other area are constructed. Afterwards distribution line will be increased, when necessary to-keep the voltage drop within 5%, according to load demand increase.

Meanwhile existing two circuits of distribution lines are assumed to be available for power plant now under planning.

(4) Distance of transmission line

For cost comparison, the distance of transmission line was assumed as follows:

Site	A	B	C
Distance in km	8	0	15

(5) Results of economical comparison

Comparing with yearly expenditure including construction cost and transmission loss, A site has an advantage, but the difference is very small. (Refer to attached Table)

Meanwhile, the construction cost for sending power to PERTAMINA was not taken into account in this cost comparison. Should this

transmission line be constructed, the site C becomes much more advantageous than others.

(6) Various dimensions used for calculation

i) Construction cost

Transmission line 150 kV 330 mm² 2 ccts ¥17,700 x 10³/Km

Distribution line

20 kV 95 mm² 1 cct ¥ 3,000 x 10³/Km

20 kV 120 mm² 1 cct 3,300 x 10³/Km

20 kV 240 mm² 1 cct 4,200 x 10³/Km

ii) Ratio of yearly expenditures: 12.42% (For transmission line)
14.92% (For distribution line)

iii) Unit cost of transmission loss

8.7 Yen/kWh 5,800 Yen/kW/year

iv) Discount rate 12%

v) Others

Power factor 0.85

Load factor 0.6

Cost Comparison Table

(50% load is concentrated in City Center)

Unit: 10⁶ Yen

Year	Peak load (MVA)	A: 10 Km to City Center		B: 18 Km to City Center		C: 3 Km to City Center		
		Plan	Cost	Plan	Cost	Plan	Cost	
1995	9.5	T/L 330 mm ² x 2 8 km	141.6	D/L 240 mm ² x 2 18 km	151.2	T/L 330 mm ² x 2 15 km	265.5	
		D/L 120 mm ² x 2 10 km	66.0		" 120 mm ² x 1 10.8km	35.6	D/L 120 mm ² x 2 3 km	19.8
		" 120 mm ² x 3 5.5km	<u>54.5</u>				" 120 mm ² x 3 5 km	<u>49.5</u>
			262.1		186.8		334.8	
96	11.5							
97	13.4							
98	15.4			D/L 240 mm ² x 1 18 km	75.6			
99	17.3							
2000	19.3	D/L 120 mm ² x 1 10 km	66.0					
01	20.6							
02	22.0			D/L 240 mm ² x 1 18 km	75.6			
03	23.3							
04	24.7			D/L 120 mm ² x 1 10.8km	35.6			
05	26.0							
Total Cost			295.1			334.8		
Present value of total cost			280.8			334.8		
(a)	Present value of yearly expenditure		249.4			288.1		
(b)	Present value of evaluated loss cost		(T/L) 1.3 (D/L) 70.8			0 78.8		
(a)+(b) Present value of total yearly expenditure			321.5			329.4		

Annex 7-1 Evaluation of Trouble Report (1984): Wilayah III

		min./consumer									times/consumer	
00	SERVICE ENTRANCE & METERING	01	02	03	04	05	06	07	08	09	10	
		6.43743	0.43414	2.20783	0.62122	0.25225	1.08495	2.72648	0.69133	1.12722	15.58285	3.37685
10	LOW VOLTAGE DISTRIBUTION	11	12	13	14	15	16	17	18	19	Total	
		4.08712	10.00053	0.54590	0.21113	1.52469	1.71558	1.20414	0.22304	1.54626	21.05839	5.07669
20	POLES	21	22	23	24	25					Total	
		0.28754	0.06865	0.26134	0.41839	0.00225					1.03817	0.20506
30	TRANSFORMERS	31	32	33	34	35					Total	
		2.22460	0.25461	0.04278	0.33554	1.19356					4.05109	2.65042
40	MEDIUM VOLTAGE LINES	41	42	43	44	45					Total	
		2.64232	17.93432	0.88398	0.90954	0.95869					23.32885	26.61064
50	MEDIUM VOLTAGE GROUND CABLE	51	52	53	54						Total	
		2.93141	0.17153	0.48587	0.05992						3.64873	1.88475
60	POWER SYSTEM	61	62	63	64						Total	
		4.53601	0.15148	0.09792	1.48578						6.27119	8.02137
70	NATURAL DISASTER	71	72	73	74	75	76				Total	
		0.30334	0.24376	0.0005	-	-	1.47739				2.02454	1.24846
	SUB TOTAL										77.00381	49.07424
80	BLACK OUT	81	82	83	84	85	86	87	88		Total	
		8.14844	2.03780	7.78310	0.30993	3.21477	0.00364	0.12988	0.30713		21.93469	3.57868
	TOTAL										98.93850	52.65292

Agenda for Annex 7-1

00. SERVICE ENTRANCE & METERING.
01. House installation fuse - blow up.
02. Metering fuse - blow up
03. Mini Circuit Breaker (MCB) - out of the function/ broken
04. Trouble in house connection cause fuse on pole/distribution station - blow up
05. Trouble in service entrance, cause fuse on pole/distribution station - blow up
06. Metering is broken down
07. Service entrance is broken down
08. House wiring is broken down
09. Others
10. LOW VOLTAGE DISTRIBUTION
11. Pole fuse - broken down
12. Distribution fuse - broken down
13. Trouble in connection cable from pad mounted distribution station to overhead lines, cause fuse distribution station - blow up.
14. Trouble on low voltage bus-bar, cause medium voltage/ low voltage fuse - blow up
15. Trouble cause by tree that makes pole fuse/distribution station fuse - blow up.
16. Isolator - trouble/broken down.
17. Low voltage distribution lines - broken down.
18. Cable connection from distribution transformer to overhead lines.
19. Others
20. POLES
21. Pole - broken down by vehicle
22. Pole - broken down cause the aged
23. Any defect on pole
24. Pole - slanting
25. Others
30. TRANSFORMERS
31. Medium voltage fuse - blow up
32. Trouble on transformer
33. Clamp - loosing
34. Circuit breaker - open
35. Others
40. MEDIUM VOLTAGE LINES
41. Medium voltage lines - broken down
42. Circuit breaker - open or fuse blow up by tree
43. Circuit breaker - open or fuse blow up cause by animal.
44. Lightning stroke
45. Others.

- 50. MEDIUM VOLTAGE GROUND CABLE
- 51. Circuit breaker - open or fuse
blow up cause by trouble on cable
- 52. Mechanical disturbance
- 53. Circuit breaker - open or
fuse blow up by animal
- 54. Others

60. POWER SYSTEM

- 61. Disturbance in power source
 - " in transmission lines
 - " in substation
- 64. Others

70. NATURAL DISASTER

- 71. Hurricane
- 72. Rain
- 73. Flood
- 74. Earthquake
- 75. Earthslide
- 76. Others

SUB - TOTALS (a)

- 80. BLACK OUT
- 81. Shortage of trouble shooter.
- 82. Caused by expansion
- 83. Caused by maintenance
- 84. Caused by low voltage change
- 85. Caused by rehabilitation
- 86. Caused by activity of other
public utility (water, telecommunication,
roads, etc.)
- 87. Caused by fire accident
- 88. Others

SUB - TOTALS (b)

T O T A L S (a) & (b)

Annex 7-2 Economically Optimum Design of the Capacity and Installation
Position of Condensers

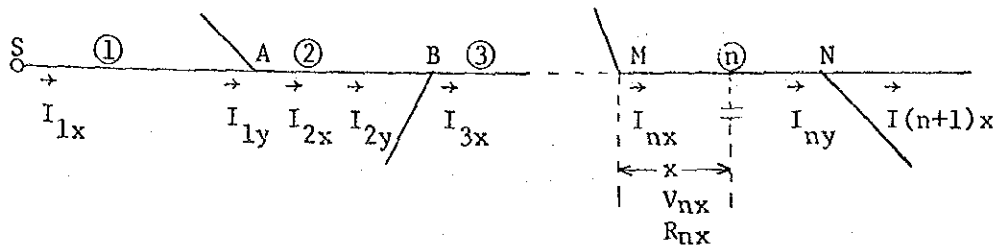

(1) Determination of installation sections

By setting an optional point x in optional section n, the installation sections of condenser I_{ox} are obtained from the formula below:

$$I_{ox} = \frac{Q}{D} = \frac{(V_1 + V_2 + \dots + V_{nx}) - V^2 \frac{\mu\beta + \gamma H\alpha}{\gamma OH}}{2(R_1 + R_2 + \dots + R_{nx})} \quad (A)$$

Where $R_1, R_2, R_3, \dots, R_n$: Resistance in the respective sections
①, ②, ③, ..., ① (Ω)

$V_1, V_2, V_3, \dots, V_n$: Voltage drop only due to resistance in the respective sections ①, ②, ③, ..., ① (V)

where $V_n = 1/2R_n (I_{nx} + I_{ny})$

D: (a) In case it is possible to meter the amount of reactive power at substation

$$D = \frac{2Q_0}{I_{1x} H}$$

Q_0 : Amount of reactive power in substation per year
kVar·h

I_{1x} : Maximum current in substation (A)

H : 24 hr. x 365 days = 8,760 hr.

(b) In case power factor is constant at all times

$$D = 2 \sqrt{3} VF \sqrt{1 - \cos^2 \theta}$$

V : Voltage (kV)

F : Load factor

$\cos \theta$: Power factor

- μ : Installation cost of condenser per KVA: Yen/KVA
- β : Yearly rate of expenditures
- γ : Unit power charge (Yen/kWh)
- α : Induction power factor. Generally, $\alpha = 0.005$

Next, a section wherein a relation like $I_{nx} > I_{ox} > I_{ny}$ should be obtained.

In case the section I_{nx} is at an end, the said position is an installation point.

When a section is obtained, it is possible to obtain I_{nx} and I_{ny} .

(2) Determination of economically optimum position and capacity of condenser

When I_{nx} and I_{ny} have been obtained from the above calculation formulas, the economically optimum capacity of condenser is:

$$Q = P - \sqrt{P^2 - q} \quad (\text{KVA})$$

$$\text{where } P = \frac{2}{3} \frac{(R_1 + R_2 + R_3 + \dots + R_{n-1})}{R_n} D (I_{nx} - I_{ny}) + \frac{2}{3} D I_{nx}^2$$

$$q = \frac{2}{3} (V_1 + V_2 + V_3 + \dots + V_{n-1}) \frac{D^2}{R_n} (I_{nx} - I_{ny}) + \frac{1}{3} D^2 I_{nx}^2 - \frac{2V^2 D (I_{nx} - I_{ny}) (\mu\beta + \gamma H\alpha) \times 10^3}{3 \gamma H R_n}$$

The economically optimum installation position of condenser is:

$$X = \frac{l}{(I_{nx} - I_{ny})} I_{nx}$$

Meanwhile, in case I_{ox} becomes a section point where $I_{ny} > I_{ox} > I_{(n-1)}$ is satisfied, the said section point is an installation point, and the capacity of condenser is determined according to the following formula:

$$Q = \frac{(V_1 + V_2 + V_3 + \dots + V_n)}{2(R_1 + R_2 + R_3 + \dots + R_n)} D$$

Annex 7-3 Study of Horizontal Line-to-Line Distance of Distribution Lines

According to the standards of PLN, the horizontal line-to-line distance is designated to be 750 mm for 20 kV distribution lines and 300 mm for low voltage distribution lines. In light of the fact that troubles are deemed to have occurred presumably due to contact of distribution lines, however, the horizontal line-to-line distance of distribution lines was studied.

For this study, the horizontal line-to-line distance required to prevent contact of conductors by rolling of conductors due to gustiness of wind was calculated using the formula shown in Fig. A.

As the results of study are indicated in Fig. A and B, it would be readily recognized that the smaller the size of conductor (lighter in weight) and the larger the sag of line conductor, the larger the horizontal line-to-line distance should be required.

In case 35 mm² AAAC conductors are strung at a sag rate of 2.0% for 20 kV distribution line, there is a possibility of line-to-line contact when the span length becomes 55 m or more. In case conductors are strung at a span length of 50 m and a sag rate of 1 or 2%, the present horizontal line-to-line distance of 750 mm is not considered to cause any particular problem unless 35 mm² or smaller conductors are used or the sag rate is especially high.

In the case of low voltage distribution lines, however, line-to-line contact is deemed to be probable as far as the present horizontal line-to-line distance is adopted. Many fusing troubles in the secondary circuits of transformers in distribution lines would have caused possibly due to such line-to-line contact. Consequently, it is considered necessary to study regarding enlargement of the line-to-line

distance of low voltage distribution lines to larger than the present distance of 300 mm or change of distribution line arrangement from horizontal to vertical arrangement.

Fig. A (for Annex 7-3) Calculation Formula of Horizontal Line-to-Line Distance

- o Horizontal line-to-line distance required for preventing line-to-line contact fault due to rolling of conductors caused by the gustiness of wind

$$Ch > 2D \sin\theta + \epsilon$$

$$> 2SK \sin\theta + 0.0035E$$

$$\theta = \tan^{-1} \frac{Ww}{Wc}$$

$$Ww = pA$$

$$= p \cdot \alpha \times 10^{-3}$$

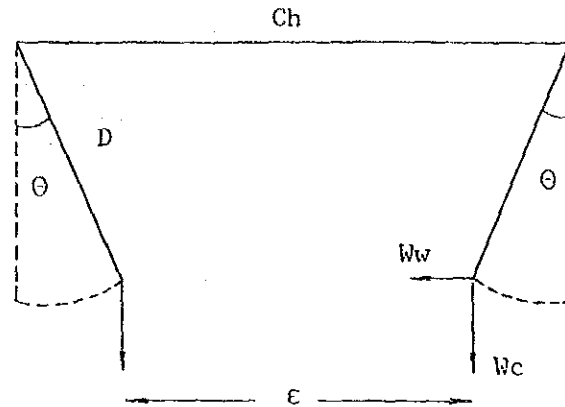

where CH: Horizontal line-to-line distance (m)

D : Sag (m)

θ : Angle of rolling due to gustiness of wind

ϵ : Flashover distance (m) in case of 50/60 Hz

S : Span length (m)

K : Sag ratio (= D/S)

E : Service voltage (kV)

Ww: Wind pressure to conductor (kg/m^2)

P : Wind pressure (kg/m^2)

$P = 4 \text{ kg/m}^2$, where equivalent wind velocity of the gustiness of wind is assumed to be 8 m/sec. (See Note 1)

A : Wind receiving area of conductor (m^2/m)

α : Outside diameter of conductor (mm)

Wc: Weight of conductor (kg/m)

Note 1. Equivalent wind velocity of gustiness of wind (Ww)

Where fluctuation of 10% of maximum wind velocity (25.0 m/sec. →

22.5 m/sec.) is taken into account, the change of wind pressure

is:

$$\begin{aligned} Ww &= KV^2 = K (25.0^2 - 22.5^2) \\ &= K(625 - 506.25) = 118.8 K \end{aligned}$$

When this value is allotted to the conductors on both sides,
then

$$\frac{118.8 K}{2} = (7.7)^2 K \approx 8^2 K$$

Therefore, the equivalent wind velocity of gustiness of wind
is 8 m/sec.

Fig. B (for Annex 7-3) Relation between span and horizontal conductor

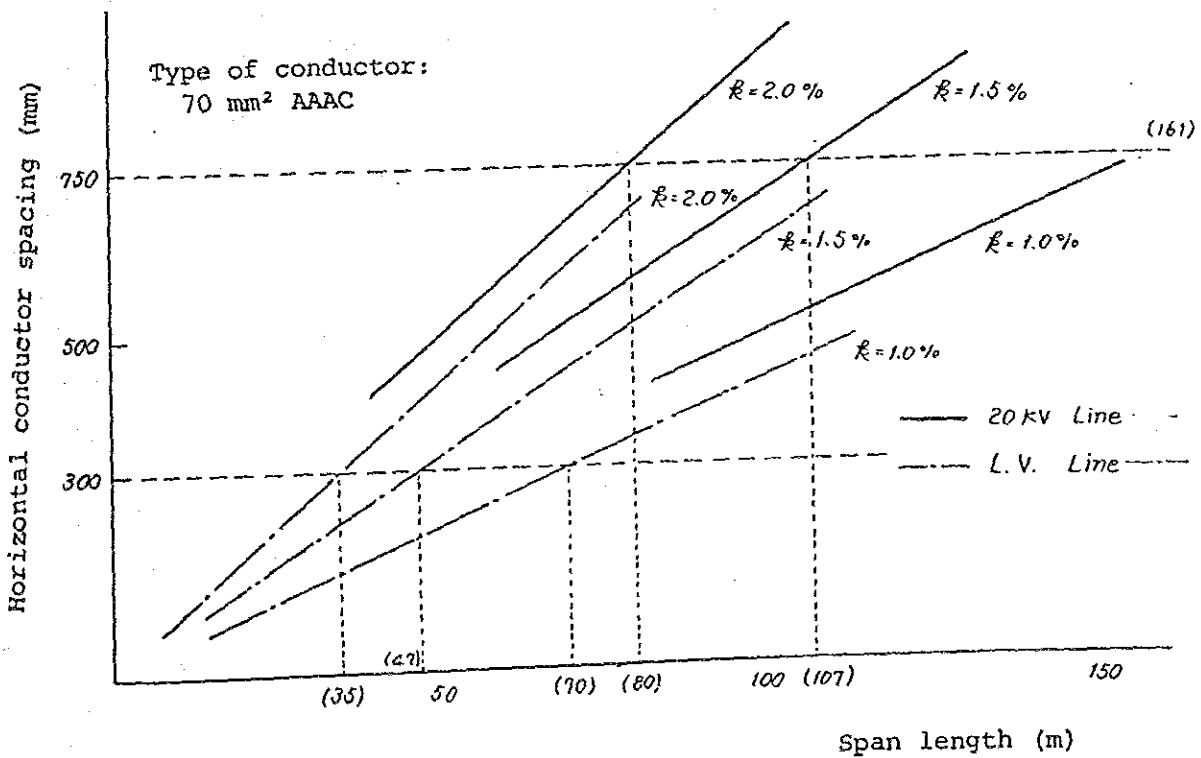
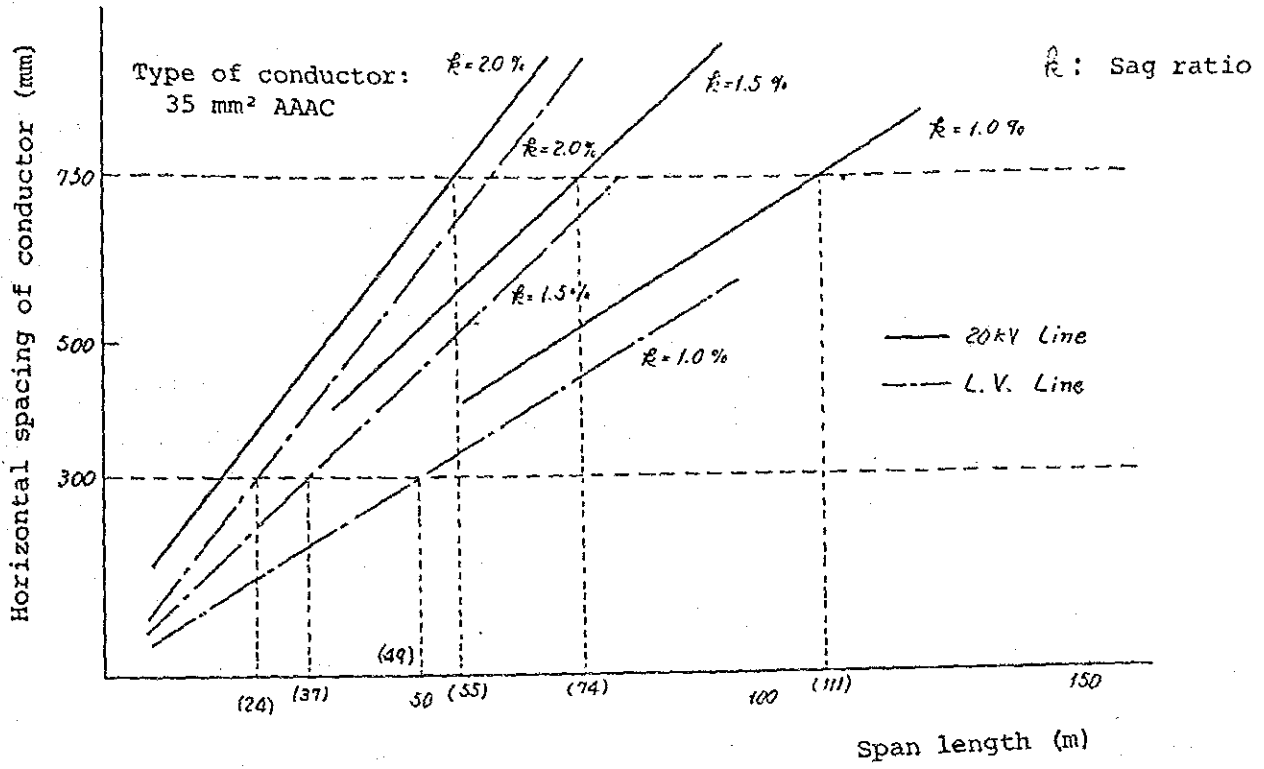

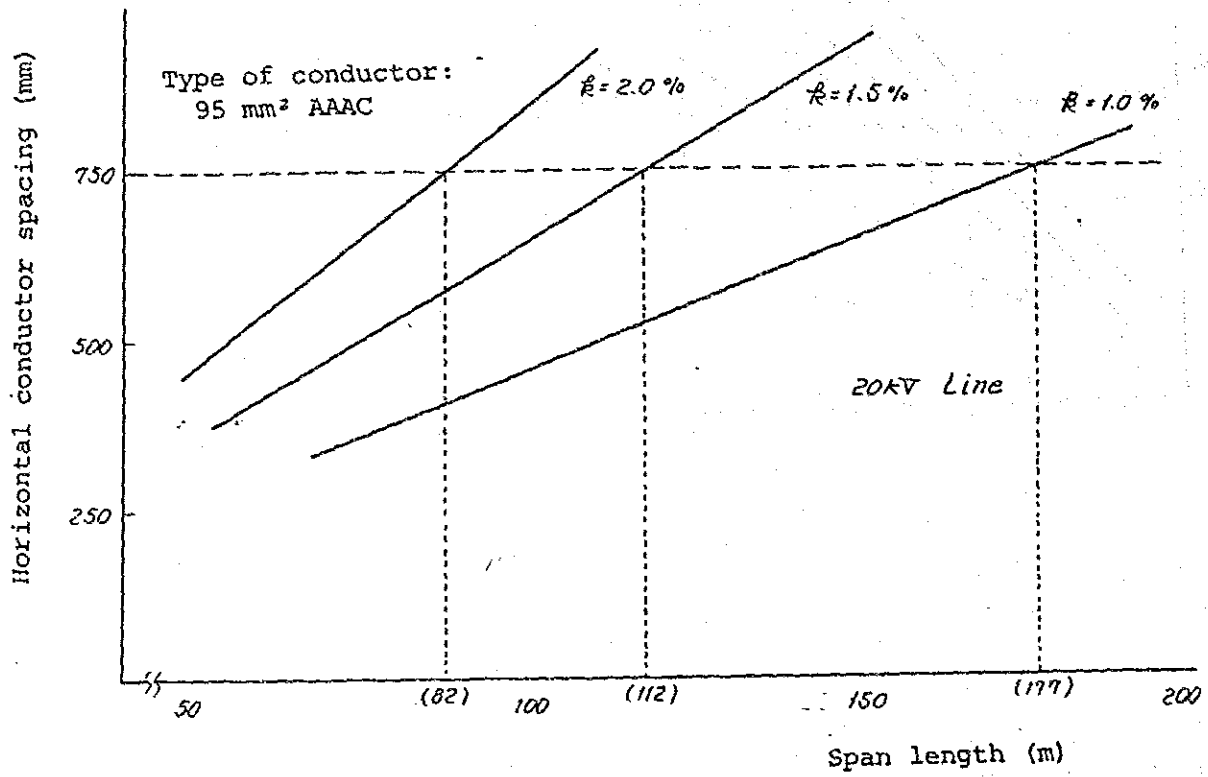

Annex 7-4 Study on Optimum Size of Conductor for
Distribution Line

(1) Objective of the study

The study aims to get the optimum size of conductors for ordinary distribution lines, and those lines as listed below are not included in the study.

- . Large scale lines to send power to city centers from power sources.
- . Loop system sometimes applied to big cities.
- . Inter-connecting lines between long distant regions.

The optimum size of conductors for these distribution lines shall be studied individually.

(2) Method of study

The study was implemented by supposing an adequate model with certain conditions for ordinary distribution lines, as below, and the conductor of minimum annual cost under these conditions is assumed as an optimum conductor for ordinary distribution lines.

a) Distribution line model

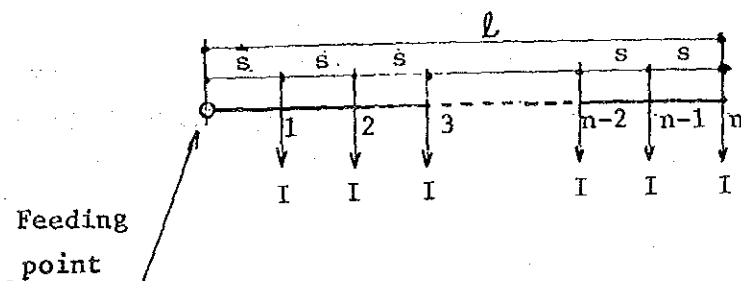

As shown in the above, a distribution line with an equal current each at branch point of an equal span length was selected as the model in the study.

b) Study conditions

i) Conductor

Five cases: AAAC 55 mm², 70 mm², 95 mm², 120 mm², 150 mm²

ii) Line length (ℓ)

Four cases: 5 km, 7 km, 10 km, 15 km

iii) Span length (s)

Four cases: 300 m, 400 m, 500 m, 600 m

iv) Load current (I)

o Initial current (In commissioning year)

Five cases: 1A (35 KVA), 2A (70 KVA)
3A (105 KVA), 4A (140 KVA)
5A (175 KVA)

o Load increase ratio: 10%/year during ten years

o Maximum total load

Three cases: 2,000 KVA + 10% (Approx. 60 A)
3,000 KVA + 10% (" 90 A)
4,000 KVA + 10% (" 120 A)

In this study, max. total load is limited by the above figure, eventhough some valves calculated by the initial current and increase ratio exceed three figures.

o Allowable voltage drop: 10% (2,000 V)

o Maximum current for each conductor:

Conductor	Continuous	Short time
AAAC 55 mm ²	200 A	250 A
" 70 mm ²	250 A	300 A
" 95 mm ²	300 A	350 A
" 120 mm ²	350 A	400 A
" 150 mm ²	400 A	450 A

(3) Calculation

a) Annual cost of conductor

$$S = \frac{A(1+i)^N + \sum_{j=0}^{N-1} W_j \cdot (1+i)^{N-1-j} - a}{N} \quad (\text{RP/m/year}) \quad \dots (1)$$

Where,

S = Average annual cost

A = Conductor price (RP/m)

N = Used period

i = Interest rate

a = Withdrawal value (RP/m)

W_j = Line loss in jth year (RP/m/year)

$$= L_f \cdot I_j^2 R \{1 + 0.0041(t-20)\} \cdot T.C. \cdot 10^{-3}$$

* I_j : Equivalent average current in jth year (A)

R : Conductor resistance at 20°C (Ω/m)

t : Conductor temperature (°C)

C : Power cost (RP/kWh)

From the condition in item (2), the figures for the above are set as follows.

A (RP/m)	500(55 mm ²)	700(70)	950(95)	1,200(120)	1,500(150)
i	0.1				
N (year)	10				
a	0				
Lf	0.3				
I (A)	1 (35KVA)	2 (70KVA)	3 (105KVA)	4 (140KVA)	5 (175KVA)
R (10 ⁻³ Ω/m)	0.534(55 mm ²)	0.447(70)	0.31(95)	0.259(120)	0.198(150)
T (Hours/year)	8,760				
C (Rp/kWh)	98.3				
ℓ (m)	5,000	7,000	10,000	15,000	
s (m)	300	400	500	600	

$$\begin{aligned}
 [I_j']^2 &= \left[\left(\frac{\ell}{s} \times I(1+g)^j \right)^2 + \left[\left(\frac{\ell}{s} - 1 \right) \times I(1+g)^j \right]^2 + \dots + \left[\left(\frac{\ell}{s} - \left(\frac{\ell}{s} - 1 \right) \right) \times I(1+g)^j \right]^2 \times \frac{s}{\ell} \right. \\
 &= \frac{I^2}{6s^2} (1+g)^{2j} (\ell+s)(2\ell+s)
 \end{aligned}$$

$$g = \text{Load increase rate/year} = 0.1$$

When put the above figures into the formula (1),

$$\begin{aligned}
 S &= \frac{A(1+i)^N + K \cdot I^2 \cdot R (1+i)^{N-1} \cdot \frac{(1+i)^N - 1}{i}}{N} \\
 &= \frac{2.6 A + 37.8 K \cdot I^2 \cdot R}{10} \dots \dots \dots (2)
 \end{aligned}$$

$$\text{Where, } K = \frac{1}{s^2} (\ell + s)(2\ell + s) \times 0.08$$

Calculation results are shown in Fig.1

b) Voltage drop

$$\epsilon = \sqrt{3} \times \frac{(\ell/s+1) \times r_e \times I_N \times \ell}{2000} \text{ (V)}$$

Where,

ℓ, s = Same as a)

I_N = Branch current in N^{th} year

r_e = Equivalent resistance (Ω/km)

$$= r \cos \theta + x \sin \theta$$

r : Line resistance (Ω/km)

x : Line inductance = $2\pi f L$ (Ω/km)

$\cos \theta$: Power factor

The figures are made out as follow.

L : 1.11×10^{-3} (55 mm^2), 1.09×10^{-3} (70 mm^2), 1.05 (95 mm^2)

1.02×10^{-3} (120 mm^2), 1.00×10^{-3} (150 mm^2)

$\cos \theta = 0.85$

Calculation results are shown in Fig. 2.

For reference, capable sending capacity (MVA) within the allowable voltage drop of 1000V (5%) for lines with the whole load at the line end is shown in Fig. 3 according to the following formula.

$$\epsilon = \sqrt{3} \times \frac{r_e I \ell}{1000}$$

(4) Evaluation

According to the results of the above calculation, the priority order of each conductors are reduced as shown in Table 1.

The priority was obtained in such a manner that the conductor with the lowest annual expenditure is given the first priority by number "1", the next by number "2", and like that.

As Table 1 shows, in small load case ($2000\text{KVA} \pm 10\%$), small size of conductors have some advantage over large size, and in large load case ($4000\text{KVA} \pm 10\%$), opposite tendency is shown.

However, the conductor 95 mm^2 has a clear advantage for the total range of max. load from $2000\text{KVA} \pm 10\%$ to $4000\text{KVA} \pm 10\%$.

(5) Conclusion

On the conditions set in the previous items, the conductor AAAC 95 mm^2 will be most recommendable for ordinary distribution lines because of the lowest annual cost in average.

Table 1. Results of Evaluation each kind of Conductor

The number in the Table shows the priority order obtained from Fig. 1.

Line length (Km)	Span length (m)	Max. load of distribution line														
		(A) 2000 KVA±10%					(B) 3000 KVA±10%					(C) 4000 KVA±10%				
		Conductor (mm ²)					Conductor (mm ²)					Conductor (mm ²)				
		55	70	95	120	150	55	70	95	120	150	55	70	95	120	150
5	300	1	1	2	2	2	1	1	1	1	1	2	2	1	1	1
	400	1	1	1	2	2	1	1	1	1	1	4	3	2	1	1
	500	1	2	3	4	5	2	2	1	1	1	5	4	3	2	1
	600	1	1	1	2	2	3	3	2	2	1	5	4	2	2	1
7	300	1	1	2	2	2	1	1	2	2	2	3	2	1	1	1
	400	1	2	3	4	5	2	2	1	1	1	3	2	1	1	1
	500	1	2	1	2	3	1	2	1	2	3	3	2	1	2	2
	600	1	2	2	3	4	3	2	1	2	2	4	3	2	2	1
10	300	x	x	x	x	x	1	1	1	1	1	1	1	1	1	1
	400	1	1	1	2	2	1	1	1	2	2	2	2	1	1	1
	500	1	1	1	2	2	2	1	1	1	1	2	1	1	1	1
	600	1	2	2	3	3	1	1	1	1	1	2	2	1	1	1
15	300	x	x	x	x	x	x	x	x	x	x	1	1	1	1	1
	400	x	x	x	x	x	1	1	1	1	1	1	1	1	1	1
	500	x	x	x	x	x	1	1	1	1	1	1	1	1	1	1
	600	1	1	1	1	1	1	1	1	1	1	1	1	1	1	1
Sub-total points		12	17	20	29	33	22	21	17	20	20	41	32	21	20	17
Priority order for each load		1	2	3	4	5	4	3	1	2	2	5	4	3	2	1

Total points = (A) + (B) + (C)

55 mm² = 12 + 22 + 41 = 75

70 mm² = 17 + 21 + 32 = 70

95 mm² = 20 + 17 + 21 = 58

120 mm² = 29 + 20 + 20 = 69

150 mm² = 33 + 20 + 17 = 70

Priority order : 95 mm² + 120 mm² + 70 mm², 150 mm² + 55 mm²

①

②

③

④

Fig. 1 Comparative Figure of Annual Expenditure among Distribution Line Conductors

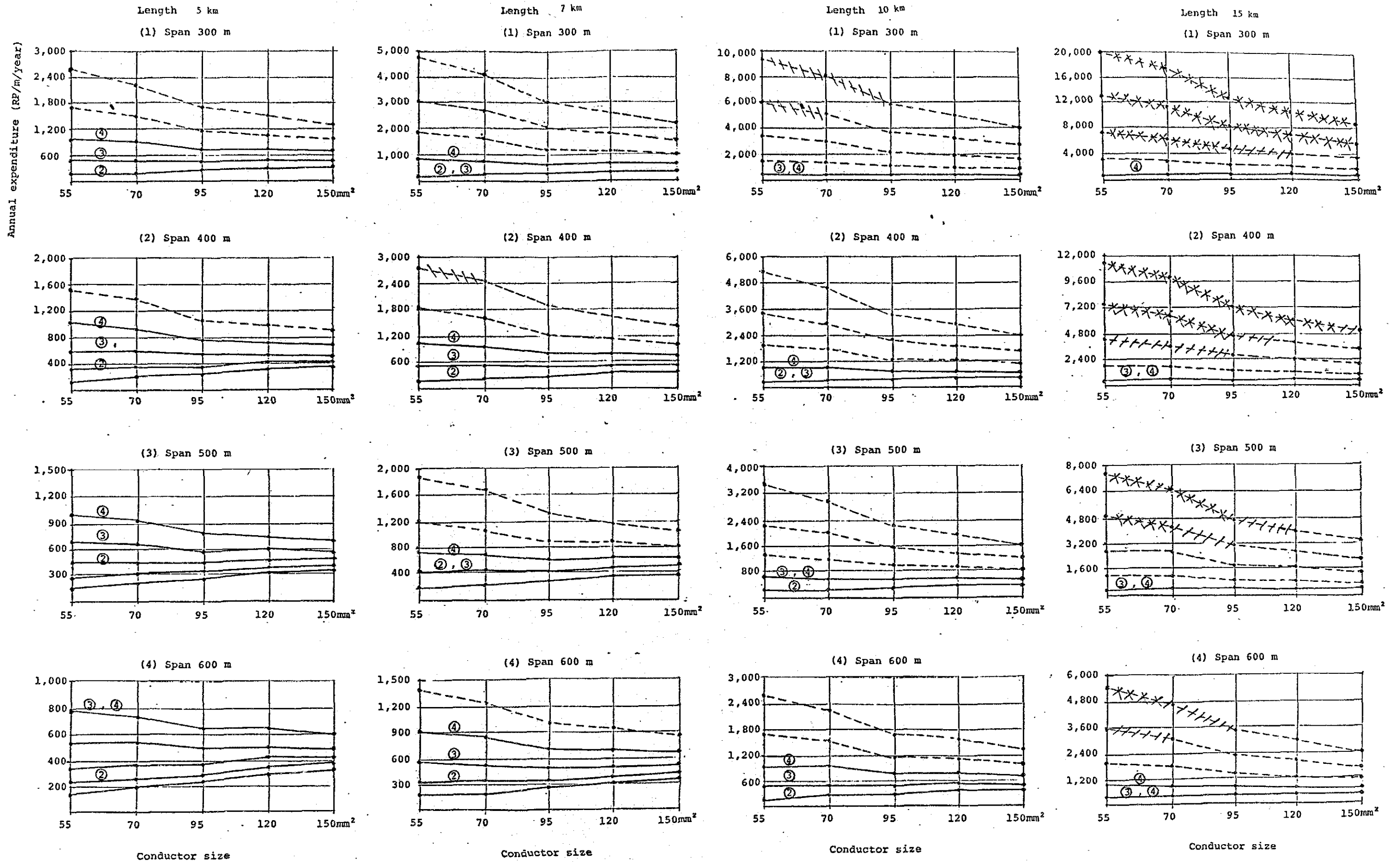

o - - - - shows the case exceeding the allowable voltage drop (10%). (Refer to Fig.2)
 o - - - - shows the case exceeding the allowable current (short time) of conductors, (Refer to item (2), a)).
 o - x - x - shows the case exceeding both of allowable voltage and current.

o The number, 4, 3 and 2, on lines means max. load of distribution line, such as,
 ④ : 4,000 KVA ± 10% or less.
 ③ : 3,000 KVA ± 10% "
 ② : 2,000 KVA ± 10% "
 o - - - - shows the case exceeding 4000 KVA ± 10% which is the max. load in this study.

Fig. 2 Maximum Voltage Drop (V) at the end of Distribution Line

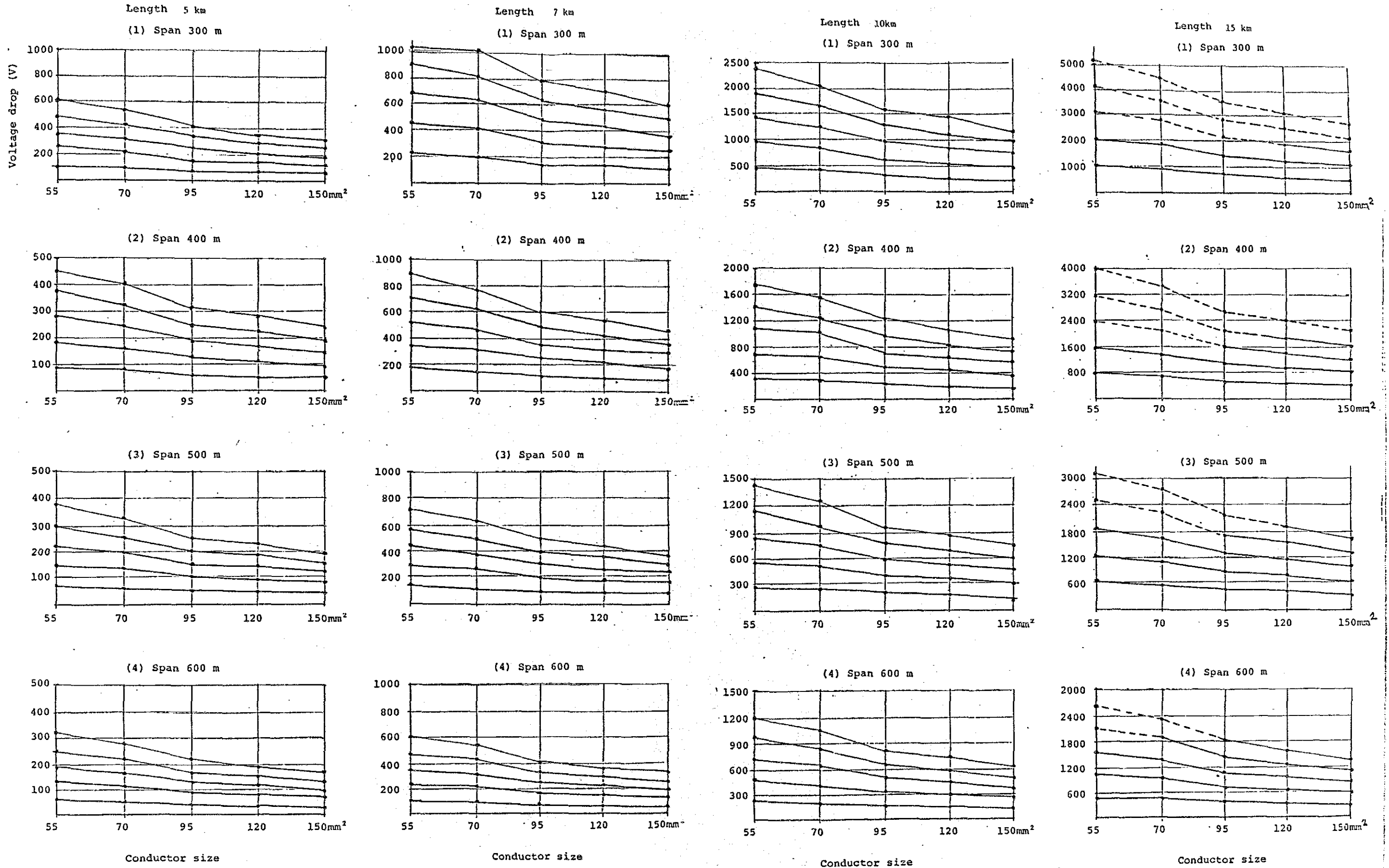

(1) The figure shows the maximum voltage drop at the end of distribution lines ten years after commissioning with the initial branch current, 1A, 2A, 3A, 4A and 5A each, and 10% annual increase.

(2) ----- snows the distribution lines exceeding 2,000 V (10%).

Fig. 3 Capable sending capacity from allowable voltage drop. (1)

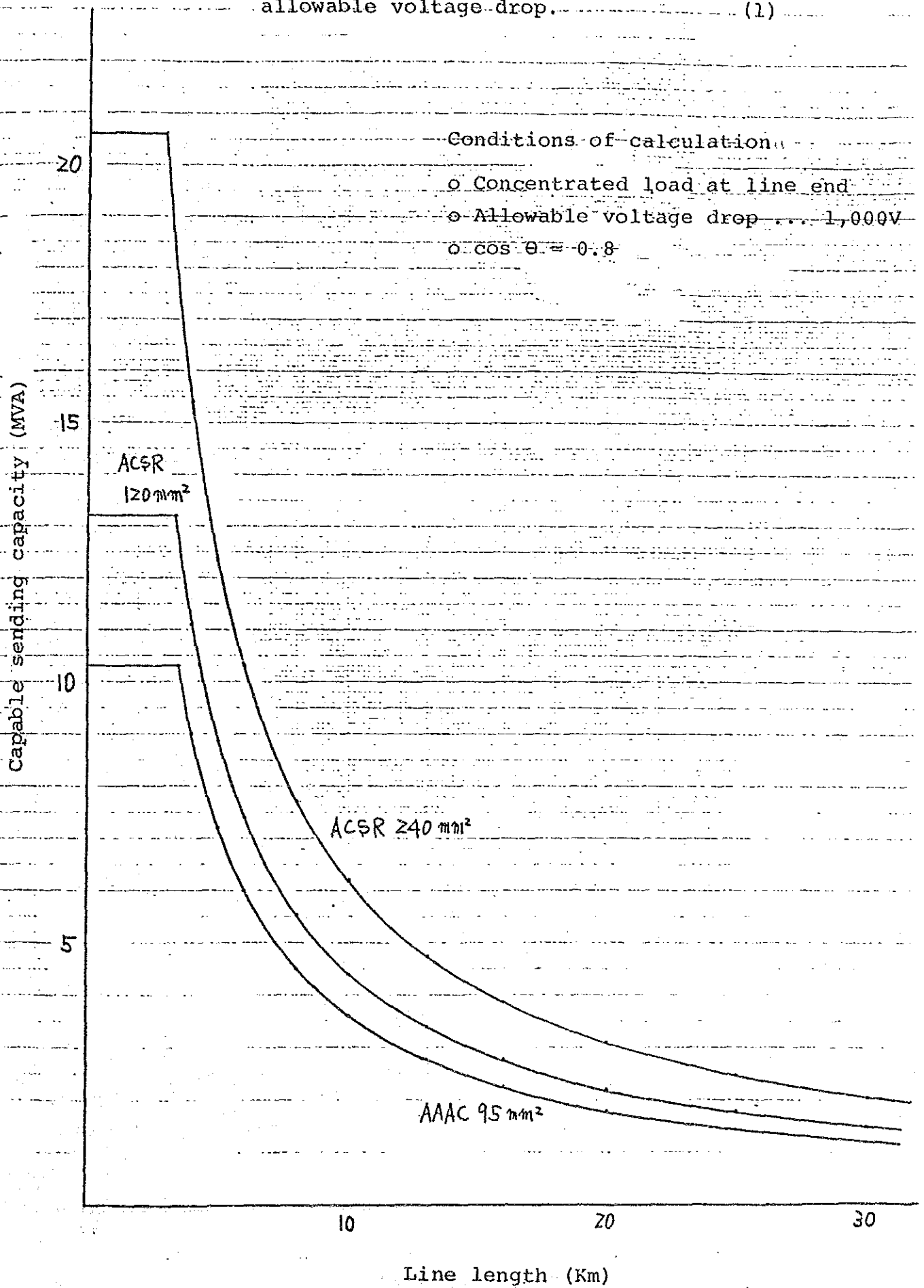

(2)

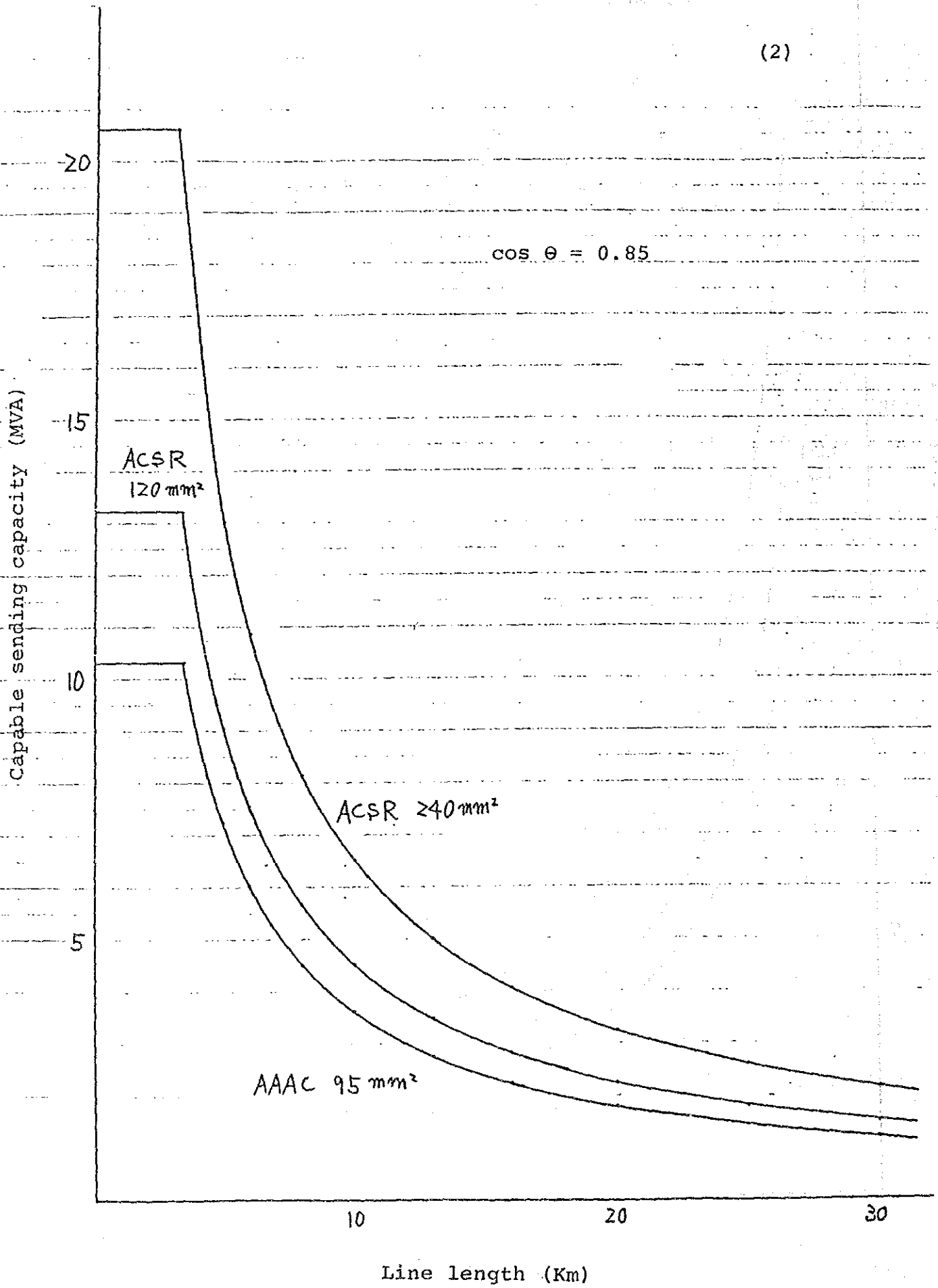

(3)

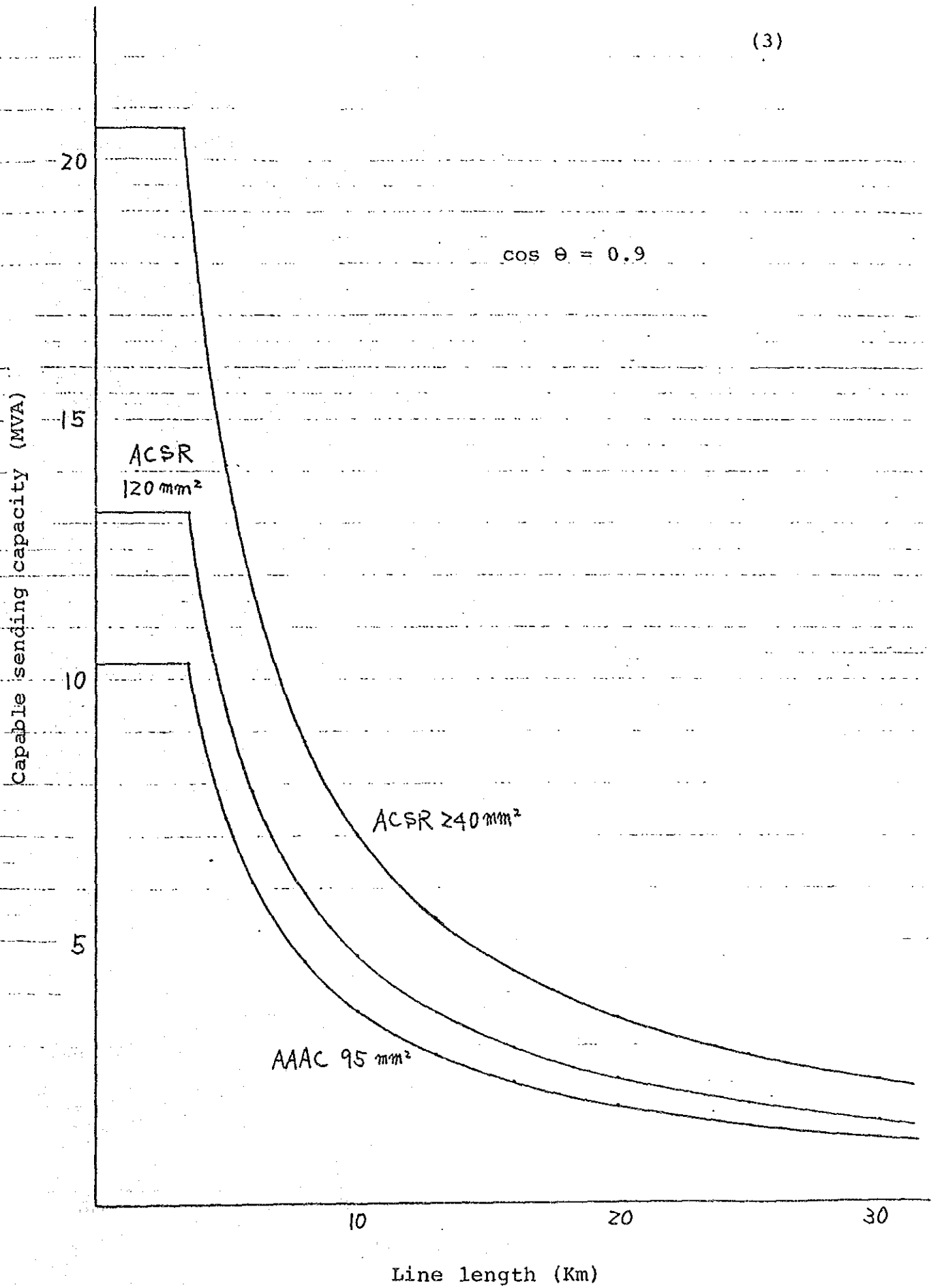

(4)

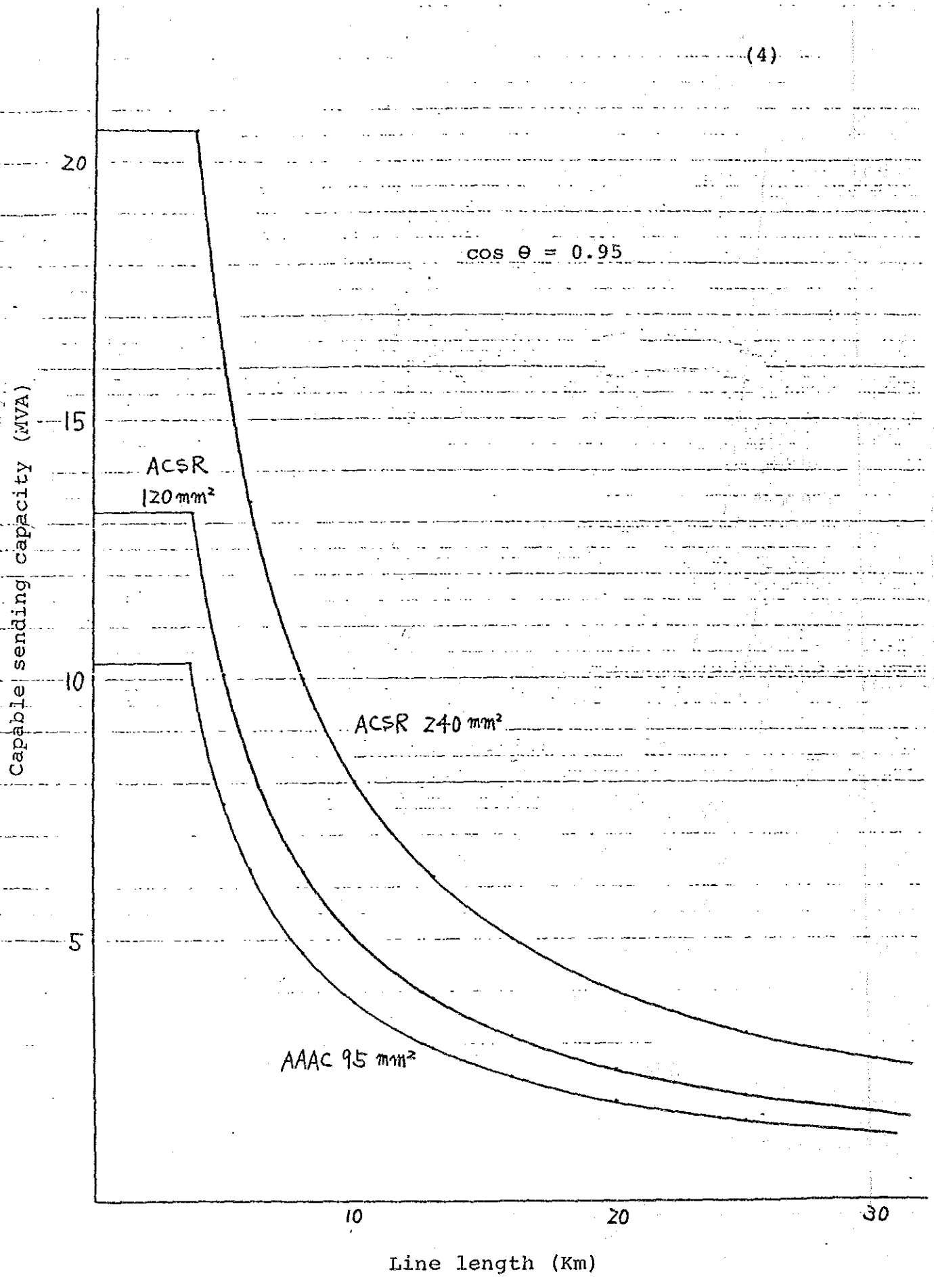

$\cos \theta = 0.95$

ACSR
120 mm²

ACSR 240 mm²

AAAC 95 mm²

Line length (Km)

Preliminary Economic Analysis
- Selection of Transmission Line Routes -

1. Approach and Assumption

A preliminary economic analysis was conducted for the purpose of selecting, and giving priority to, transmission line routes which are to be covered by this feasibility study.

The approach employed in the analysis was to compare the cost, in terms of net present value (NPV), of the following alternative schemes:

- Alternative 1: To supply electricity to load centers such as Pekanbaru and Dumai through transmission lines from the planned large power stations, i.e., Ombilin, Singkarak, and Kotapanjang.
- Alternative 2: To supply electricity by installing a diesel generator at each load center.

Assuming that the transmission lines would start operation in 1995, the routes whose cost was less expensive or very close to the cost of the diesel alternative were tentatively regarded as an economically feasible project and picked up for more detailed analysis in the feasibility study.

The cost items included in the NPV comparison and their assumed values were as follows:

- Transmission Alternative:
- * Power supply cost from the planned hydro and thermal power plants: Rp.47.9/kwh
 - * Construction cost of transmission lines and substations: Rp.126.5 million/km
 - * Annual operation/maintenance cost of transmission lines and substations: 1.5 percent of their construction cost
 - * Transmission loss: 3 percent of gross generation
- Diesel Alternative:
- * Power generation cost of diesel power plants: Rp.104.9/kwh

All the costs are expressed in March-April 1984 price. Distribution costs were not included in the NPV comparison since they were common to both alternatives. The power supply cost of hydro and thermal power plants were computed as a weighted average cost of Ombilin, Singkarak, and Kotapanjang. The discount rate used for NPV calculation was 10 percent. Details of the assumptions are stated in the attached "Notes on Assumptions."

2. Results and Their Sensitivity

The transmission routes analysed and their results are summarized as below:

Result of the Analysis: Base Case

Routes	NPV (Rp.million)			IRR (%)
	Diesel (1)	Transmission (2)	Cost Saving (1)-(2)	
Payakumbuh-Pekanbaru	333,803	177,819	155,984	25.8
Pekanbaru-Dumai	177,130	103,157	73,973	18.5
Duri-Bagan Siapiapi	21,497	21,140	357	4.4
Ombilin-Tenbilahan	100,232	93,382	6,850	5.4
Padang-Painan	17,537	16,131	1,406	5.6
Painan-Sungai Penuh	29,303	36,075	-6,772	-
Bangkinang-Ujungbatu	6,902	13,723	-6,821	-
Padang Luar-Lubuk Sikaping	8,662	10,631	-1,969	-

In the table, "Cost Saving" is defined as "Diesel cost less Transmission cost". Obviously, positive value in this column means that transmission project is less expensive than the diesel alternative and negative value implies the opposite. In addition to NPV, in order to see relative magnitude of economic impacts of each transmission line, an internal rate of return (IRR) was computed taking electricity sales revenues at the present tariff level as benefits.

Since the parameters used for the above analysis were very crudely estimated, it is necessary before drawing a definite conclusion to examine the effects of difference in cost estimate. Hence, sensitivity of the base case analysis was tested by altering the assumed parameters both upward and downward by 20 percent. The result of this sensitivity analysis are summarized in the table of next page.

Based on these analyses, it has now become clear that the routes of "Payakumbuh-Pekanbaru" and "Pekanbaru-Dumai" appear to be economically feasible even if large unfavourable change in the assumed value occurred. In fact, the economic advantage of connecting Pekanbaru and Dumai was assured by further testing the case where the potential demand of Pertamina in Dumai, which was partly accommodated in the demand projection used for the base case analysis, was completely dropped off. The result was cost saving of Rp.17,795 million and IRR of 10.0 percent. On the other hand, as for the routes of "Painan-Sungai Penuh", "Bangkinang-Ujung Batu", and "Pdang Luar-Lubuk Sikaping", the conclusion that it is too early to implement them will be not reversed although more favourable conditions were applied. Some ambiguity still remains regarding "Duri-Bagan Siapiapi", "Ombilin-Tenbilahan", and "Padang-Painan". As long as the base case are concerned, they are feasible. Nevertheless, small change in assumed values would blow off their small margin of cost saving.

Result of Sensitivity Analysis

Routes	(Unit: Rp. billion)											
	-20%			+20%			-20%			+20%		
	Diesel Power Cost	Demand	Power Supply Cost	Transmission Const. Cost	Discount Rate	Base Case	Discount Rate	Transmission Const. Cost	Diesel Power Cost	Demand	Power Supply Cost	
Payakumbuh - Pekanbaru	89.2	120.7	124.4	152.0	126.4	156.0	195.3	160.0	193.8	191.2	222.8	
Pekanbaru - Dumai	38.5	55.3	57.2	70.1	57.9	74.0	95.4	77.9	90.7	92.7	109.4	
Duri - Bagan Siapiapi	-3.9	-1.9	-1.7	-1.8	-1.3	.4	2.6	2.6	2.4	2.6	4.6	
Ombilin - Tenbilaan	-13.2	-3.7	-2.6	-2.4	-1.0	6.9	17.5	16.1	16.3	17.4	26.9	
Padang - Pekanbaru	-2.1	-5	-3	-2	.0	1.4	3.3	3.0	3.1	3.3	4.9	
Rainan - Sungai Penuh	-12.6	-9.9	-9.5	-11.2	-8.8	-6.8	-4.0	-2.3	-4.0	-3.7	-1.0	
Bangkaing - Ujung Batu	-8.2	-7.6	-7.4	-8.9	-7.2	-6.8	-6.3	-4.7	-6.1	-6.1	-5.4	
Padang Luar - Lubuk Sikaping	-3.7	-2.9	-2.8	-3.3	-2.6	-2.0	-1.2	-.7	-1.1	-1.0	-.2	

It should be noted that, before selecting the routes used in the above analyses, the following three alternative routes for covering the demand in Riau were compared.

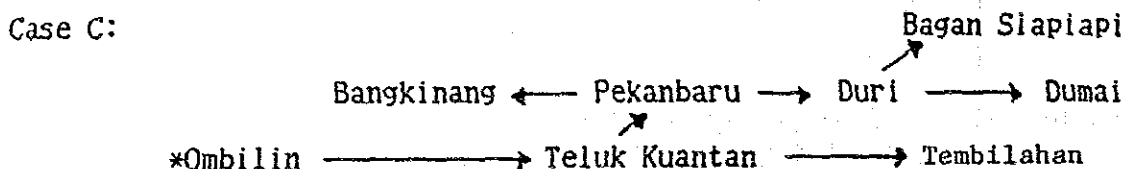
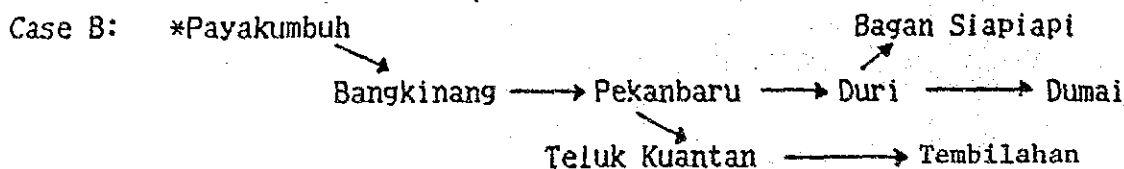
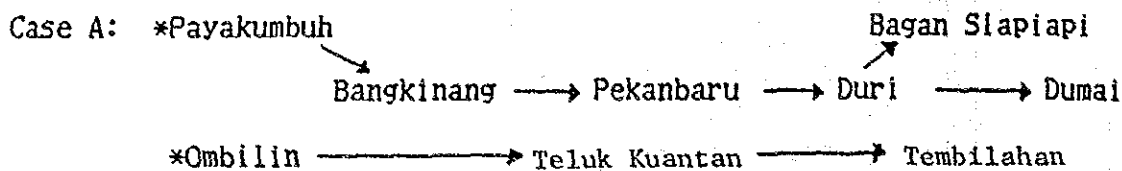

The result of comparing these three routes were as below:

<u>Case</u>	<u>Cost Saving</u>	<u>IRR</u>
A	Rp.237.2 billion	15.8%
B	Rp.232.6 billion	15.3%
C	Rp.228.3 billion	14.8%

The above figures tell us that Case A is most advantageous from economic viewpoint although difference is small.

3. Conclusion

Based on the preceding analyses, it is concluded that the following routes should be regarded as a strong candidate project to be implemented by 1995:

- * Payakumbuh - Pekanbaru
- * Pekanbaru - Dumai

The routes indicated below need more accurate analysis before making a decision on whether they should be implemented by 1995 or not. Accordingly, in addition to the two routes mentioned above, they should be covered by this feasibility study.

- * Duri - Bagan Siapiapi
- * Ombilin - Tembilahan
- * Padang - Painan

The following routes are not worthwhile further consideration in this feasibility study:

- * Painan - Sungai Penuh
- * Bangkinang - Ujung Batu
- * Padang Luar - Lubuk Sikaping

Notes on Assumptions (for Annex 11-1)

1. All the costs used in the analysis were expressed in March-April 1984 price. The assumed exchange rate was US\$ 1.00 = Rp.1,100.
2. Major cost items included in the cost comparison were as follows:

- Diesel Alternative: * Power generation cost of diesel plants.
- Transmission Alternative: * Power supply cost of Ombilin, Singkarak, and Kotapanjang stations.
- * Construction and annual operation/maintenance cost of transmission lines and substations.
- * Transmission loss.

Note that construction and operation/maintenance cost of distribution lines were not included since they were common to both alternatives. However, precisely speaking, loss of electricity by distribution lines was included because the generation costs of the electricity lost were different.

3. For simplicity of computation, costs incurred in construction and operation of transmission lines near Ombilin and Singkarak, i.e., Ombilin - Batusangkar - Payakumbuh - Padang Luar and Lubuk Alang - Padangpanjang - Batusangkar, were shared by Ombilin and Singkarak power stations. As a result, about Rp.1.7/kwh was added to the power supply cost calculated based on the conditions described in item 8. below.
4. The discount rate used for computing net present value was 10 percent.
5. For reference purpose, an internal rate of return was calculated taking revenues from electricity sales at the present tariff level as a proxy of economic benefits. The assumed average tariff was Rp.98.3/kwh. In IRR computation, costs for construction and operation of distribution lines were added to the cost items of the Transmission Alternative for NPV comparison mentioned above.
6. The demand assumed to be covered in 1995 by each section of transmission line and its length was as follows:

<u>Section</u>	<u>Demand(kwh)</u>	<u>Length(km)</u>
Payakumbuh-Pekanbaru	327.4	145
Pekanbaru-Dumai	138.8	149
Duri-Bagan Sapi	18.5	84
Bangkinang-Ujung Batu	2.9	80
Padang Luar-Lubuk Sikaping	7.9	50
Padang-Painan	14.4	60
Painan-Sungai Penuh	24.5	170
Ombilin-Tembilahan	82.9	352

Note that the Demand includes demand of en route and ending point of the section; however, demand of starting point is not included.

The demand quoted above may slightly different from the final version of the projection to be discussed with PLN during the second field survey period; however, small difference will not hurt the substance of this analysis.

7. It is assumed that the transmission lines would be able to cover the the demand, starting in 1995, upto 2000 without substantial additional investment.
8. Power supply cost(Rp./kwh) of diesel, Ombilin, Singkarak, and Kotapanjang power stations were estimated using the average incremental cost method(AIC) at 10 percent discount rate with a plant factor of 60 percent. Major parameters used in the estimation process were as follows:

1) Diesel

- * Investment cost: Rp.534,600/kw (obtained from "the cost reference book compiled by PLN = PLN Cost Data") The assumed capacity for this unit cost was 3.5 - 6.0 MW.
- * Diesel oil price: Rp.220/liter(PLN Cost Data)
- * Fuel cost: Rp.73/kwh(PLN Cost Data)
- * O/M cost other than fuel: 20 percent of fuel cost(estimated from PLN's Annual Financial Information)
- * Service life: 20 years
- * Electricity consumption by power station: 2.5 percent of gross generation

2) Ombilin

- * Investment cost: Rp.79.6 billion for 100MW(obtained from F/S report and adjusted to March-April 1984 price)
- * Coal price: Rp.49,500/Ton(PLN Cost Data)
- * Fuel cost: Rp.24/kwh(PLN Cost Data)
- * O/M cost other than fuel: 35 percent of "coal" fuel cost(estimated from PLN's Annal Financial Information as an average of existing thermal plants)
- * Service life: 25 years
- * Electricity consumption by power plant: 7 percent of gross generation

3) Singkarak

- * Investment cost: Rp.255.5 billion for 200MW(obtained from F/S report and adjusted to March-April 1984 price)

- * O/M cost: Rp.4/kwh(estimated from PLN's Annual Financial Information as an average of existing hydro power plants)
- * Service life: 40 years
- * Electricity consumption by power plant: .5 percent of gross generation

4) Kotapanjang

- * Investment cost: Rp.196.4 billion for 111MW(obtained from F/S report and adjusted to March-April 1984 price)
- * Other Parameters: same as Singkarak

9. Costs related to transmission lines and substations were estimated employing the following approach and parameters:

- * Unit investment cost per km was estimated firstly summing up the total construction cost of transmission lines and substations necessary for connecting Payakumbuh and Dumai and covering the demand along the line and, then, by dividing the total cost by the length of the transmission line. The unit cost of major equipment and materials used in this estimation process was obtained from PLN Cost Data.
- * Annual O/M cost: 1.5 percent of initial investment cost
- * Transmission loss:3.0 percent of electricity supplied to the transmission system

10. Costs related to distribution lines were estimated employing the following approach and parameters:

- * Unit investment cost per km of both MV and LV lines were estimated by summing up cost of such as cables and pole-transformers based on the quotations in PLN Cost Data.
- * Regarding the length of distribution lines, it was estimated considering the data of other administrative regions and investment program in Wilayah III that, on the average, about 1.5 km of MV and 3.0 km of LV lines would be required for covering the demand of 1 MWh in the year around 2000. Applying this factor to the demand in 2000, the total length of necessary distribution line was computed as a first step. Then, subtracting the length of existing lines, the length to be constructed by 2000 was obtained.
- * The weighted average cost of distribution lines thus estimated was Rp.16.1 million/km.
- * Annual O/M cost: 4.0 percent of initial investment cost
- * Distribution loss:10.0 percent of electricity supplied to the transmission system

Annex 11-2 Justification of Commissioning Year, 1993 of
Transmission Line to Pekanbaru from the Technical
View Point

1. Expected output of power plants in Pekanbaru in 1993

Generator Output (kW)	Commissioning Year	Expected Output in 1993 (kW) *		
800	1975	556		
2,430	1976	1,724		
2,000	1977	1,448		
2,000	1977	1,448	in operation	7,456
2,000	1977	1,448		
520	1982	416		
520	1982	416		
6,380	1987	5,651		
6,380	1987	5,651		
6,380	1987	5,651	Ongoing	28,255
6,380	1987	5,561		
6,380	1987	5,651		
6,000	1990	5,647	Committed	5,647
Total 13 units		41,358		

* Assumed 2%/year declining of output

Actual output in 1993

When considered - one unit inspection plus one unit fault

- plant consumption rate 2.5%

$$41,358 - (5,651 \times 2) = 30,056$$

$$30,056 \times 0.975 = 29,305$$

About 29 MW can be expected.

2. Demand forecast and expected output in Pekanbaru

Year	Peak Demand		Expected Output	
	MW	MVA	MW	MVA
1991	24.0	28.2	30.5	35.9
1992	26.0	30.6	29.9	35.2
1993	42.4	49.9	29.3	34.5
1994	44.5	52.3	28.7	33.8
1995	46.6	54.9	28.1	33.1

(Power factor 0.85) (Refer to Fig. 6.3-2)

3. In 1992, expected output will come to the limit and earliest construction of transmission line is desired. Considering the required construction period, 1993 will be the earliest year for commissioning of transmission line.

JICA