

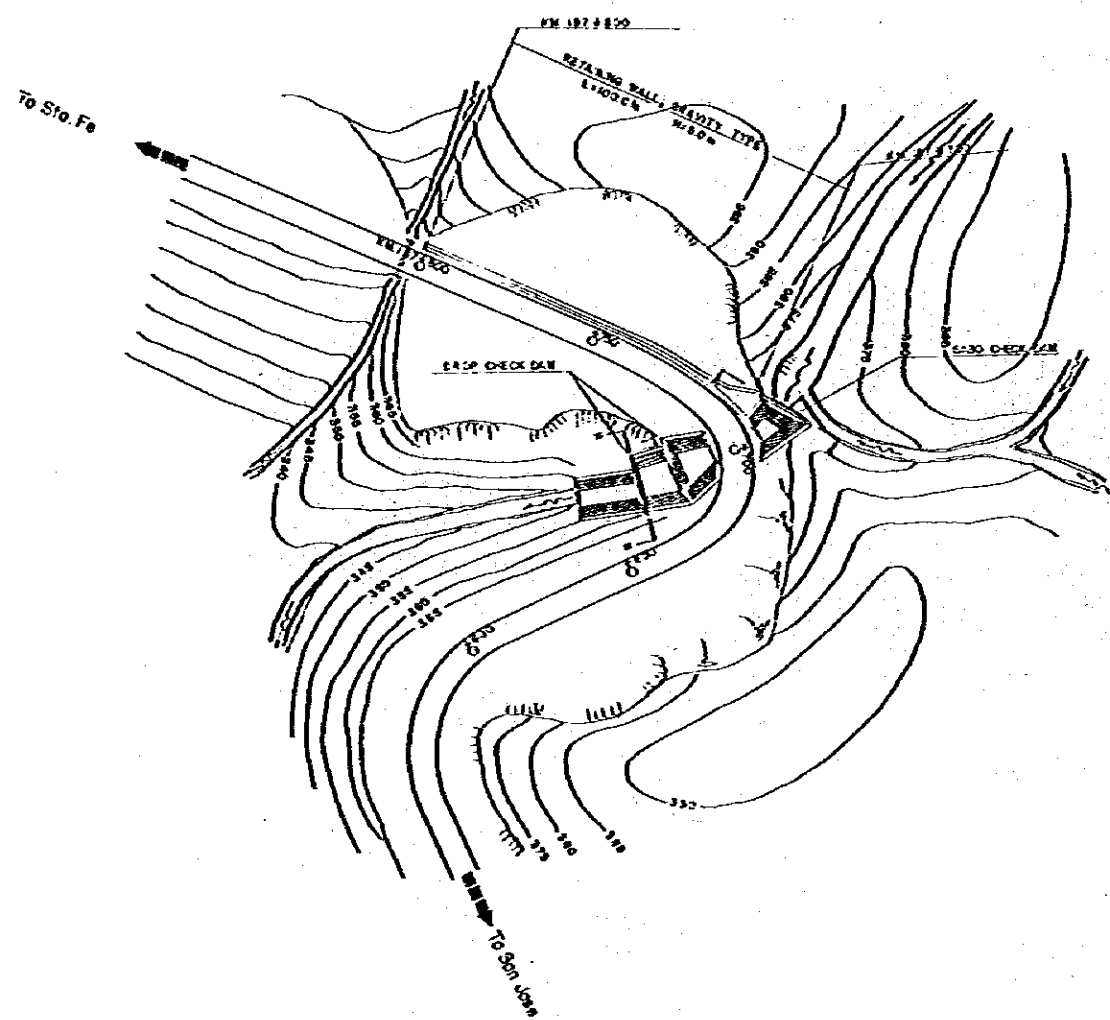

PLAN  
SCALE 1:200



ESTIMATE OF QUANTITIES

DESCRIPTION	UNIT	QUANTITIES	REMARKS
EXCAVATION FOR STRUCTURE	Cu M	920	
RETAINING WALL GRAVITY TYPE (H=500m)	L M	100	
SIDE DITCH	L M	110	
STONE MASCARY FOR WATERWAY (H=500m)	L M	69	
STONE MASCARY FOR WATERWAY	L M	28	
CONCRETE FOR SABO DAM	Cu M	185	
CONCRETE FOR DROP CHECK SLUTE	Cu M	426	
CONCRETE FOR RIVER BED	Cu M	140	

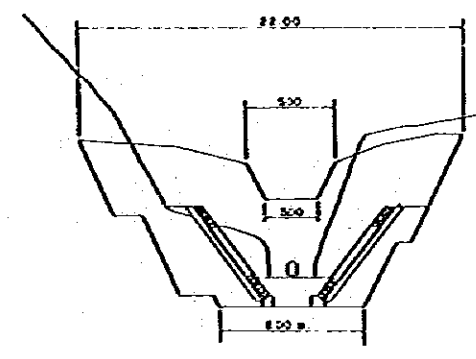

SABO (CHECK) DAM  
Section A-A  
SCALE 1:200

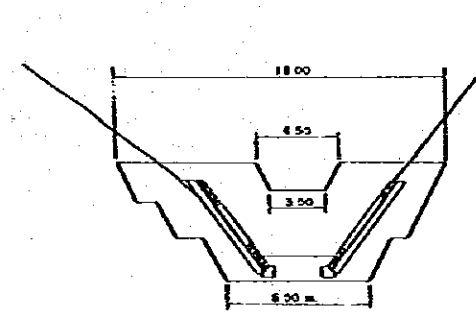

DROP CHECK DAM  
Section B-B  
SCALE 1:200

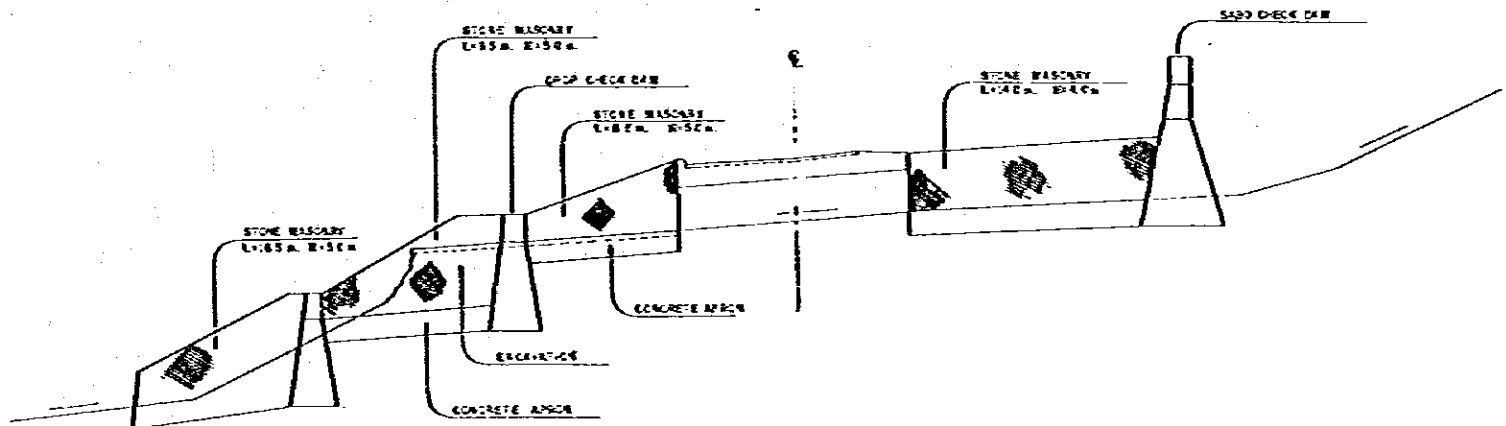

PROFILE OF RIVER  
SCALE 1:200

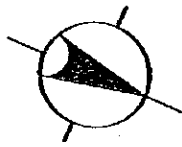

PLAN  
SCALE: 1:500

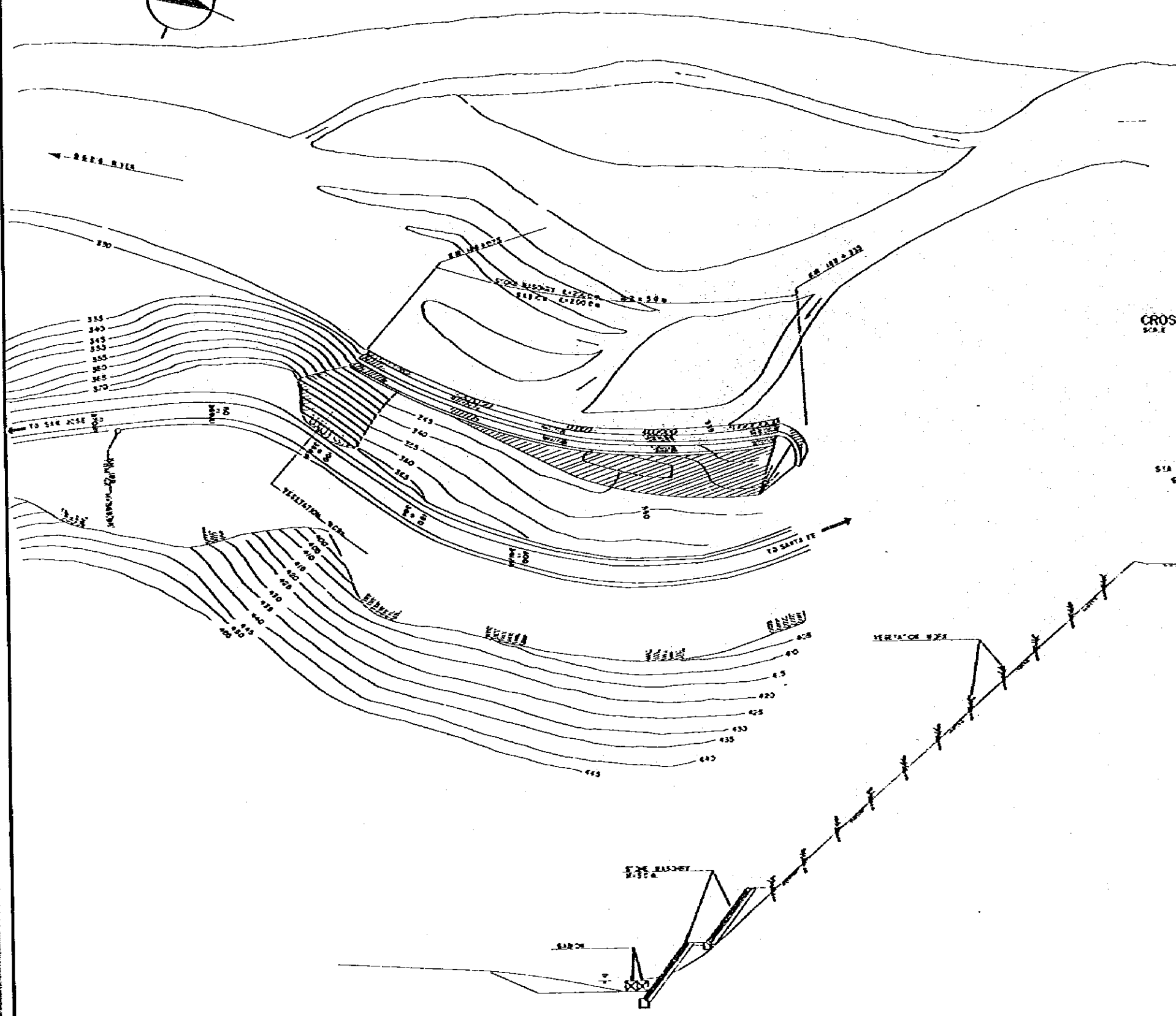

CROSS SECTION  
SCALE: 1:200

STA 188 + 100.00  
ELEV. 3665.5'

DL = 360.0

VEGETATION SCHEMATIC

STONE MASONRY WATERWAY

SECTION

DL = 320.0

ESTIMATE OF QUANTITY

DESCRIPTION	UNIT	QUANTITIES	REMARKS
PLANTATION WORK	L.M.	350	
STONE MASONRY FOR WATERWAY (+5 CM)	L.M.	400	
EMBANKMENT	Cu.M.	2400	
EASON	Cu.M.	400	

JAPAN INTERNATIONAL COOPERATION AGENCY

DALTON PASS TUNNEL PROJECT  
FEASIBILITY STUDY

SECTION B - COUNTERMEASURE WORK  
SLOPE PROTECTION

KM. 188 + 065.00 TO KM. 188 + 335.00

DATE: MAR '82

GRAPHIC NO.

RB-14

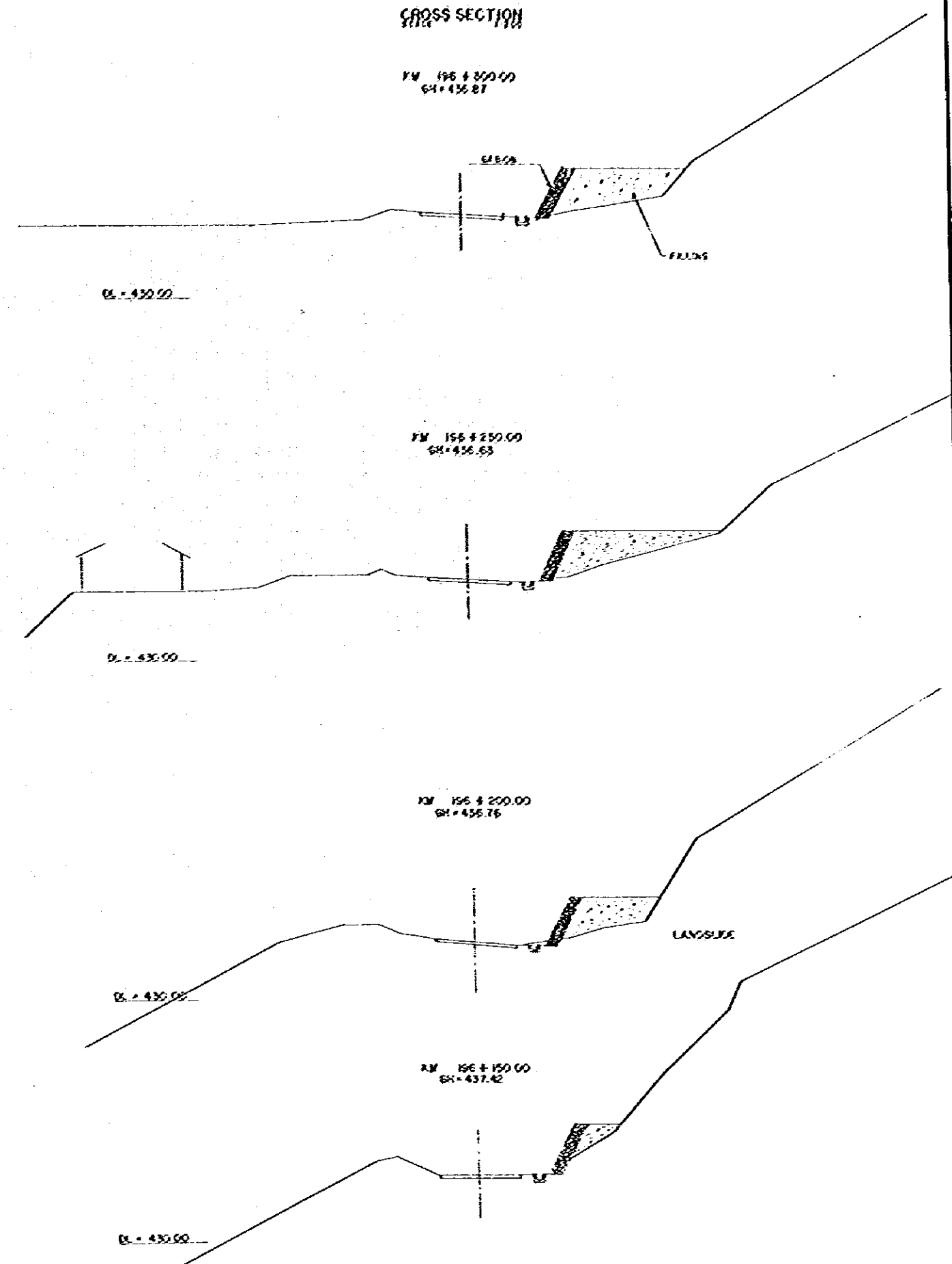
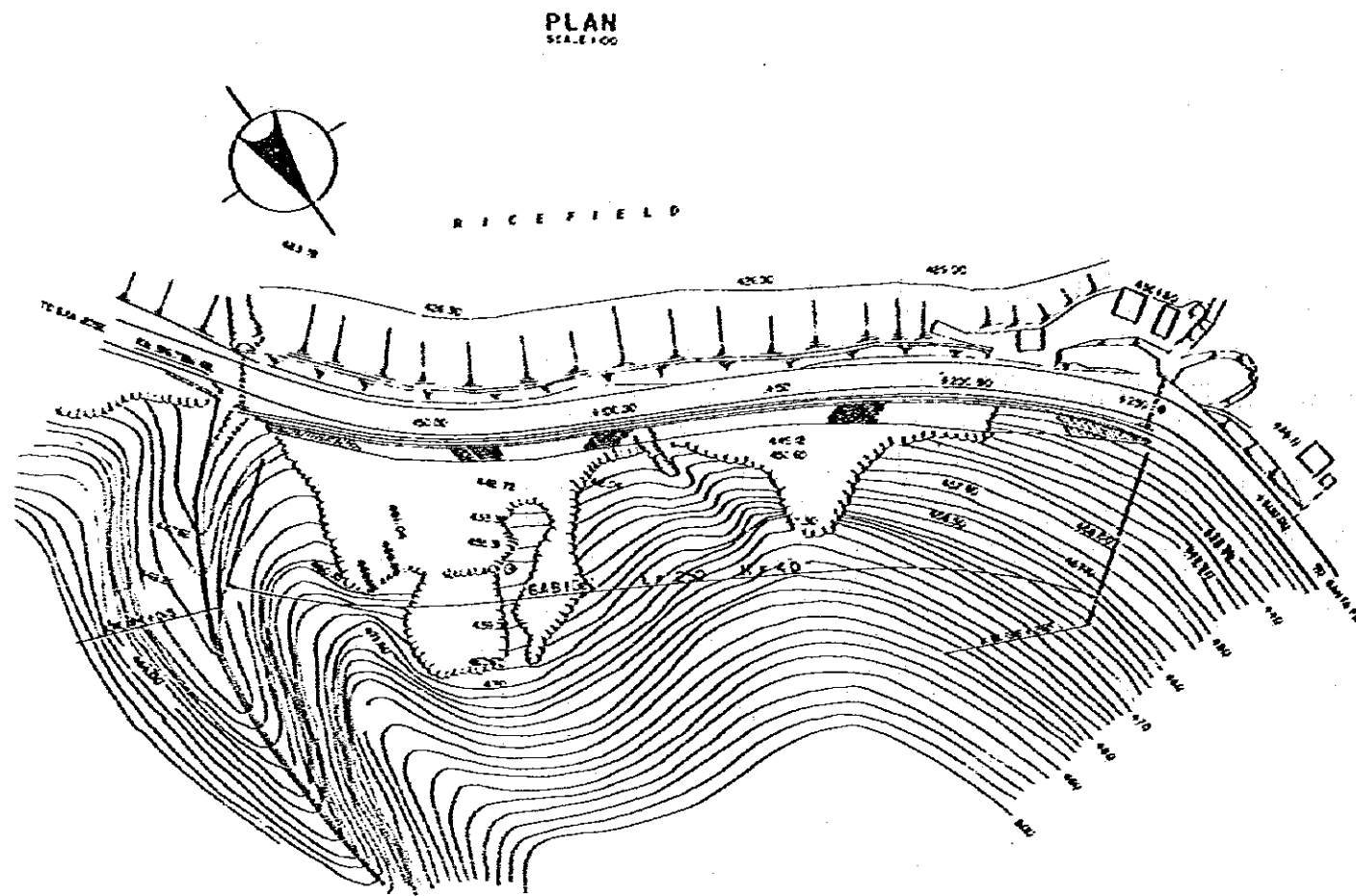

ESTIMATE OF QUANTITY

DESCRIPTION	UNIT	QUANTITIES	REMARKS
EMBANKMENT	CUM	6500	
SIDE PITCH	L.M	260	
BANK	CUM	1000	





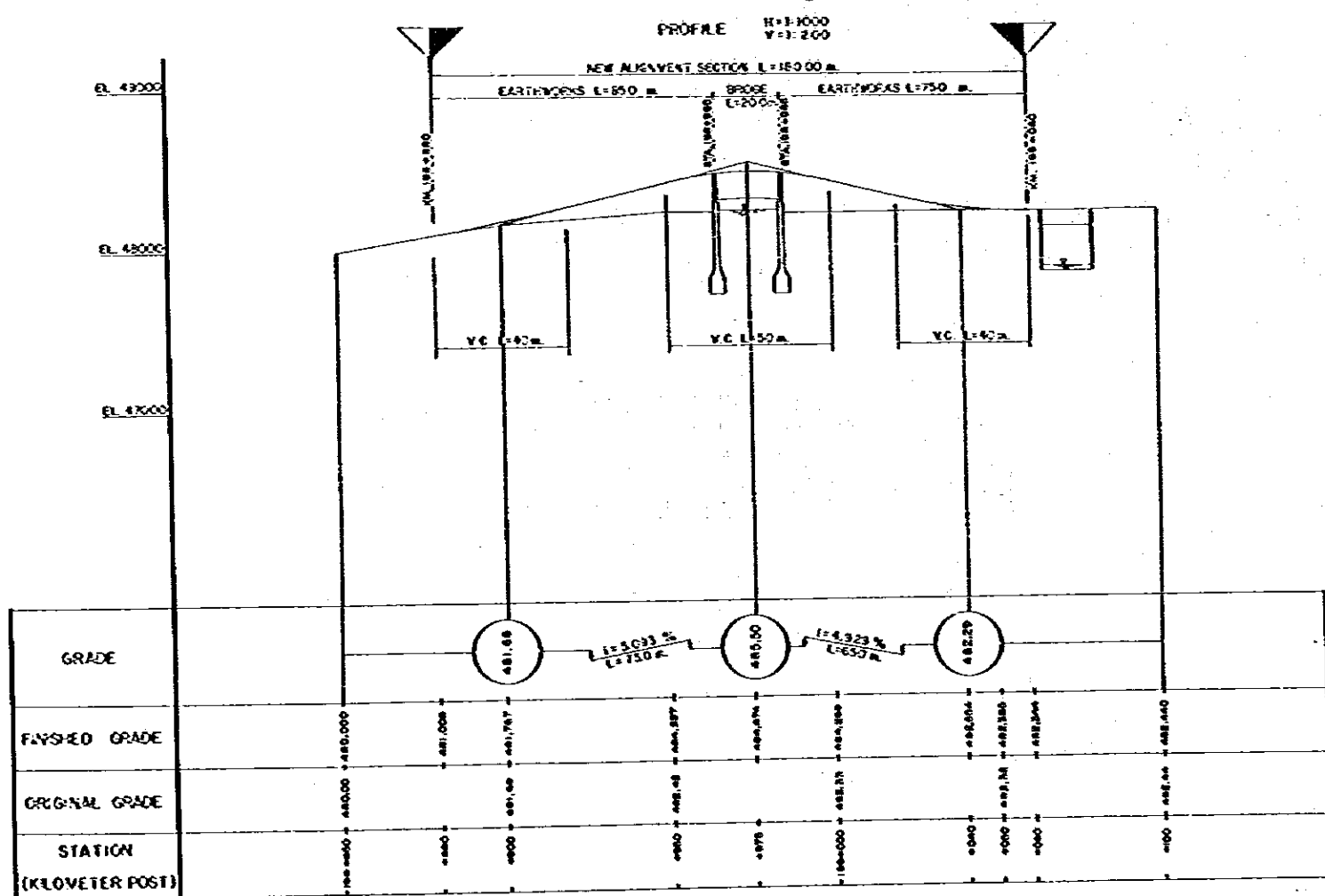
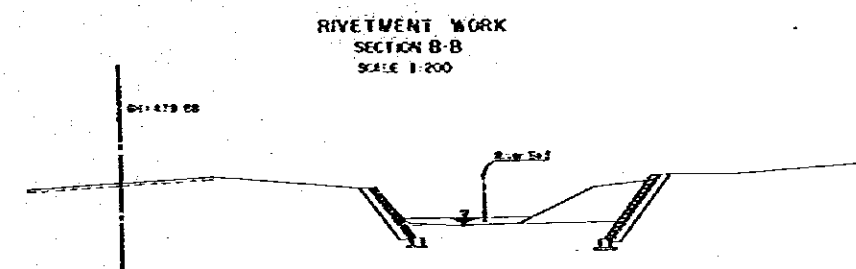
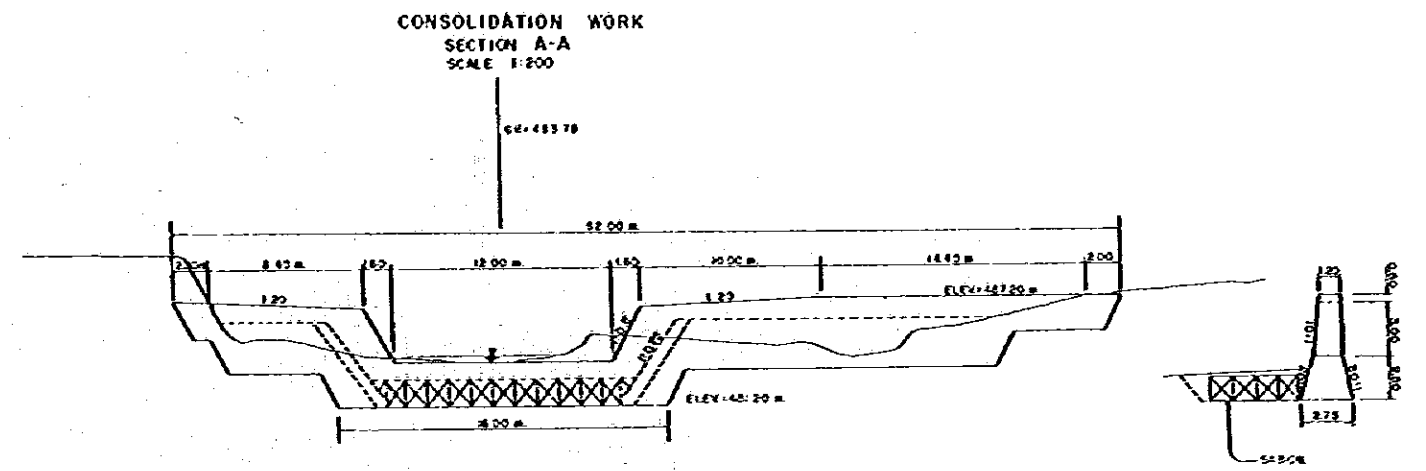
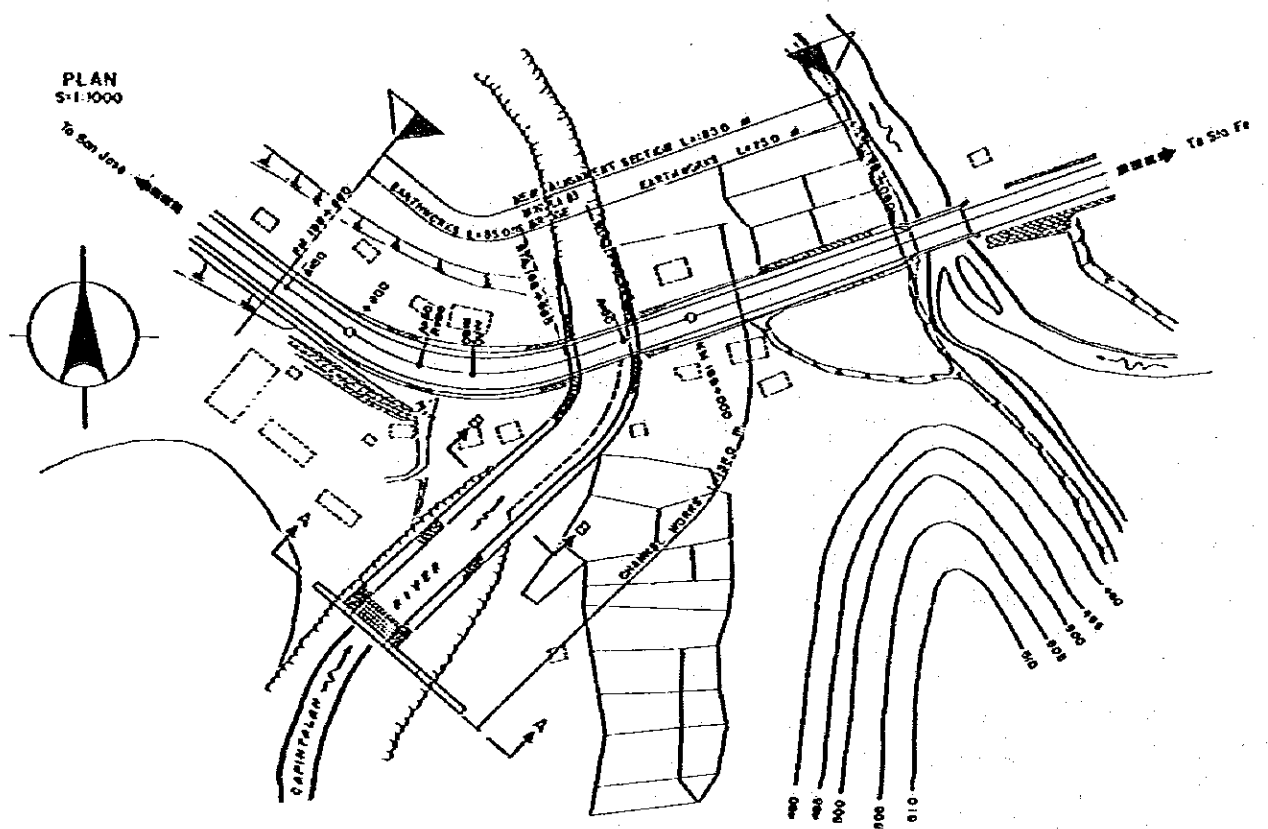

ESTIMATE OF QUANTITIES

DESCRIPTION	UNIT	QUANTITIES	REMARKS
EMBANKMENT	Cu.M	1350	
CONCRETE RIVEMENT	L.M	160	1-23 cm.
STONE MASONRY FOR EMBANKMENT (H=20m)	L.M	320	
STONE MASONRY FOR WATERWAY (L=35m)	L.M	270	
EXCAVATION FOR STRUCTURE	Cu.M	510	
CONSOLIDATION	Cu.M	370	
BARON	Cu.M	100	
BRIDGE L=20.00 m	Long span	1	

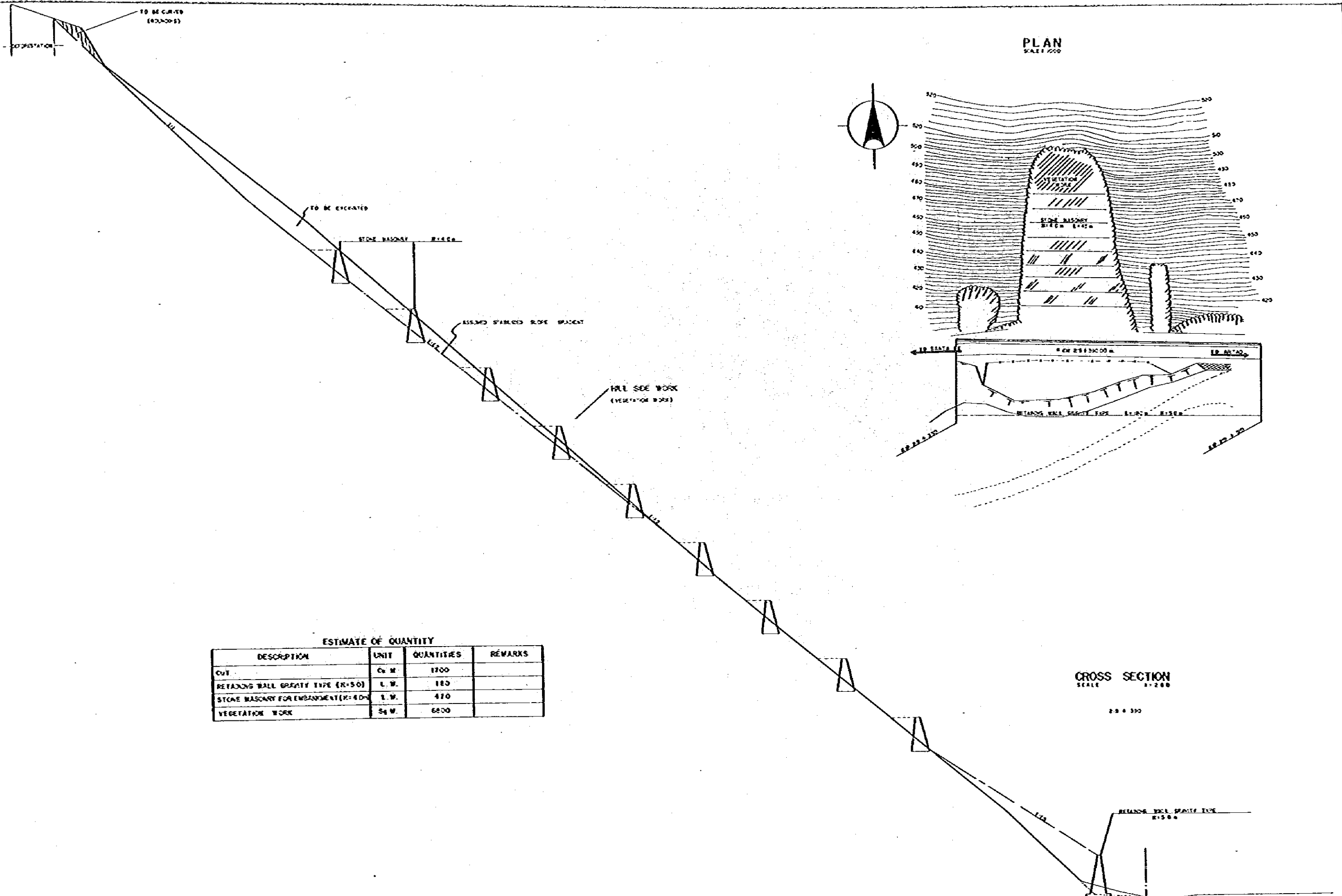

ESTIMATE OF QUANTITY

DESCRIPTION	UNIT	QUANTITIES	REMARKS
CUT	Cu. M.	1700	
RETAINING WALL GRAVITY TYPE (R-5.0)	L. W.	180	
STONE MASCART FOR EMBANKMENT (R-4.0)	L. W.	470	
VEGETATION WORK	Sq. M.	6800	

CROSS SECTION  
SCALE 1:200

2.8 x 3.90

PLAN  
SCALE 1:1000

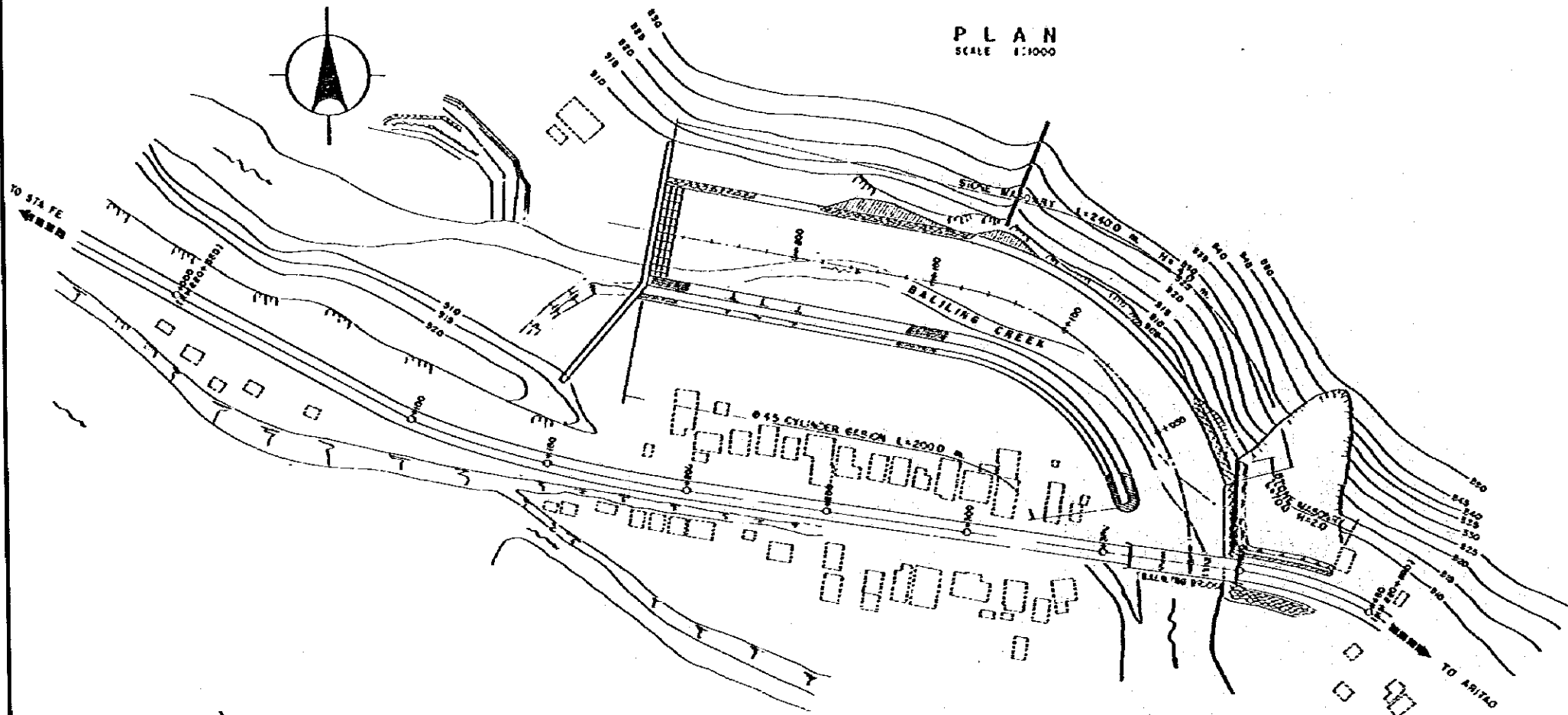

ESTIMATE OF QUANTITIES

DESCRIPTION	UNIT	QUANTITIES	REMARKS
EXCAVATION FOR STRUCTURE	Cu M.	8800	
EVENIMENT	Cu M.	1250	
CONCRETE FOR CONSOLIDATION	Cu M.	980	
STONE MASONRY FOR WATER WAY (H=4.0 m)	L. M.	240	
STONE MASONRY FOR WATER WAY (H=2.0 m)	L. M.	70	
EASION	Cu M.	1450	

CONSOLIDATION WORKS  
SCALE 1:200

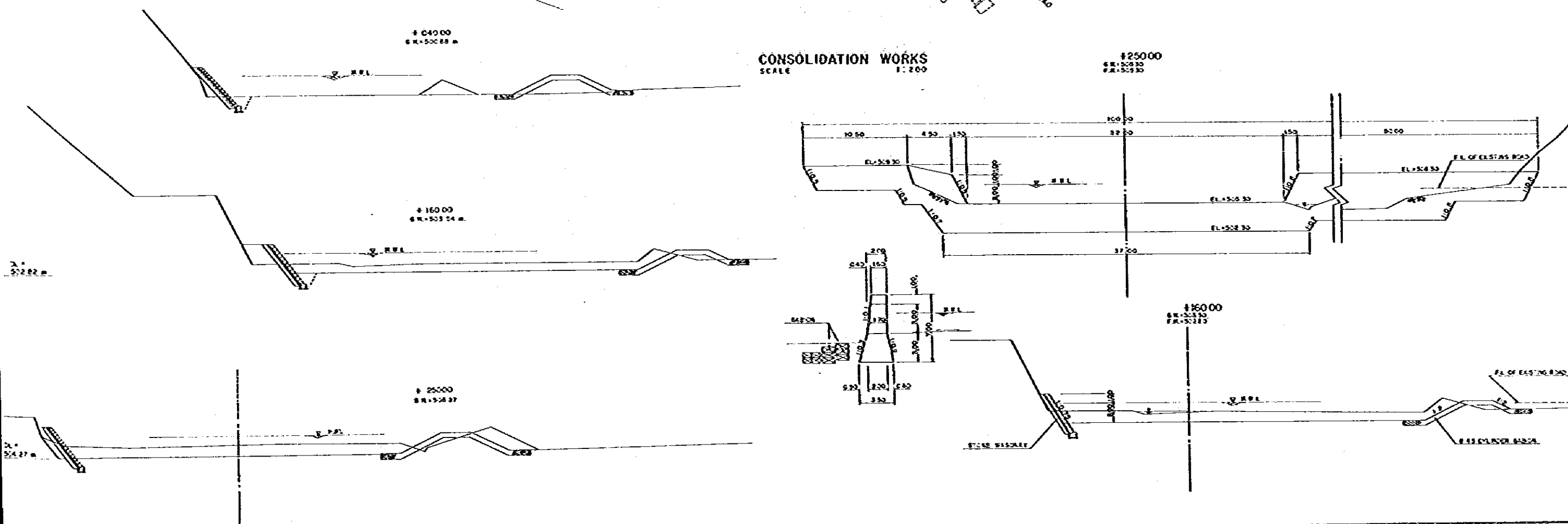

JAPAN INTERNATIONAL COOPERATION AGENCY

DALTON PASS TUNNEL PROJECT  
FEASIBILITY STUDY

SECTION B - COUNTERMEASURE WORK  
CHANNEL AND SLOPE PROTECTION  
KM 220+155000 TO KM 220+90000  
DATE: MAR '82

DRAWING NO.  
RB-20



**PART 4**  
**GEOLOGY AND GEOTECHNICAL**  
**INVESTIGATION**

## TABLE OF CONTENTS

### PART 4 GEOLOGY & GEOTECHNICAL INVESTIGATIONS

GS-1	LINEAMENT MAP S=1/50,000
GS-2	LINEAMENT MAP OF SECTION-A S=1/5,000
GS-3	GEOLOGICAL MAP S=1/50,000
GS-4	GEOLOGICAL MAP OF SECTION-A S=1/5,000
GS-5	GEOLOGICAL PROFILE S=1/5,000
GS-6	LOCATION MAP OF GEOTECHNICAL INVESTIGATIONS S=1/5,000
GS-7	RESULTS OF BORING SURVEY S=1/5,000
GS-8	BORING COLUMNAR (1)
GS-9	BORING COLUMNAR (2)
GS-10	BORING COLUMNAR (3)
GS-11	TRAVEL TIME CURVE S-1
GS-12	PROFILE OF VELOCITY LAYER S-1
GS-13	TRAVEL TIME CURVE AND PROFILE OF VELOCITY, LAYER S-2
GS-14	TRAVEL TIME CURVE AND PROFILE OF VELOCITY, LAYER S-3
GS-15	TRAVEL TIME CURVE AND PROFILE OF VELOCITY, LAYER S-4
GS-16	TRAVEL TIME CURVE AND PROFILE OF VELOCITY, LAYER S-5
GS-17	VELOCITY OF BASE ROCK ON TUNNEL FORMATION
GS-18	PERMEABILITY TEST
GS-19	UNCONFINED COMPRESSION TEST (1)
GS-20	UNCONFINED COMPRESSION TEST (2)
GS-21	AMOUNT OF SPRINGWATER FROM TUNNEL
GS-22	DAMAGED LOCATION CAUSED BY TYPHOONS S=1/50,000
GS-23	LOCATION MAP OF THE SITES TO BE IMPROVED, S=1/50,000
GS-24	CHECK PORTION FOR SLOPE STABILITY S=1/50,000
GS-25	DALTON PASS AERIAL PHOTOGRAPHIC AREA

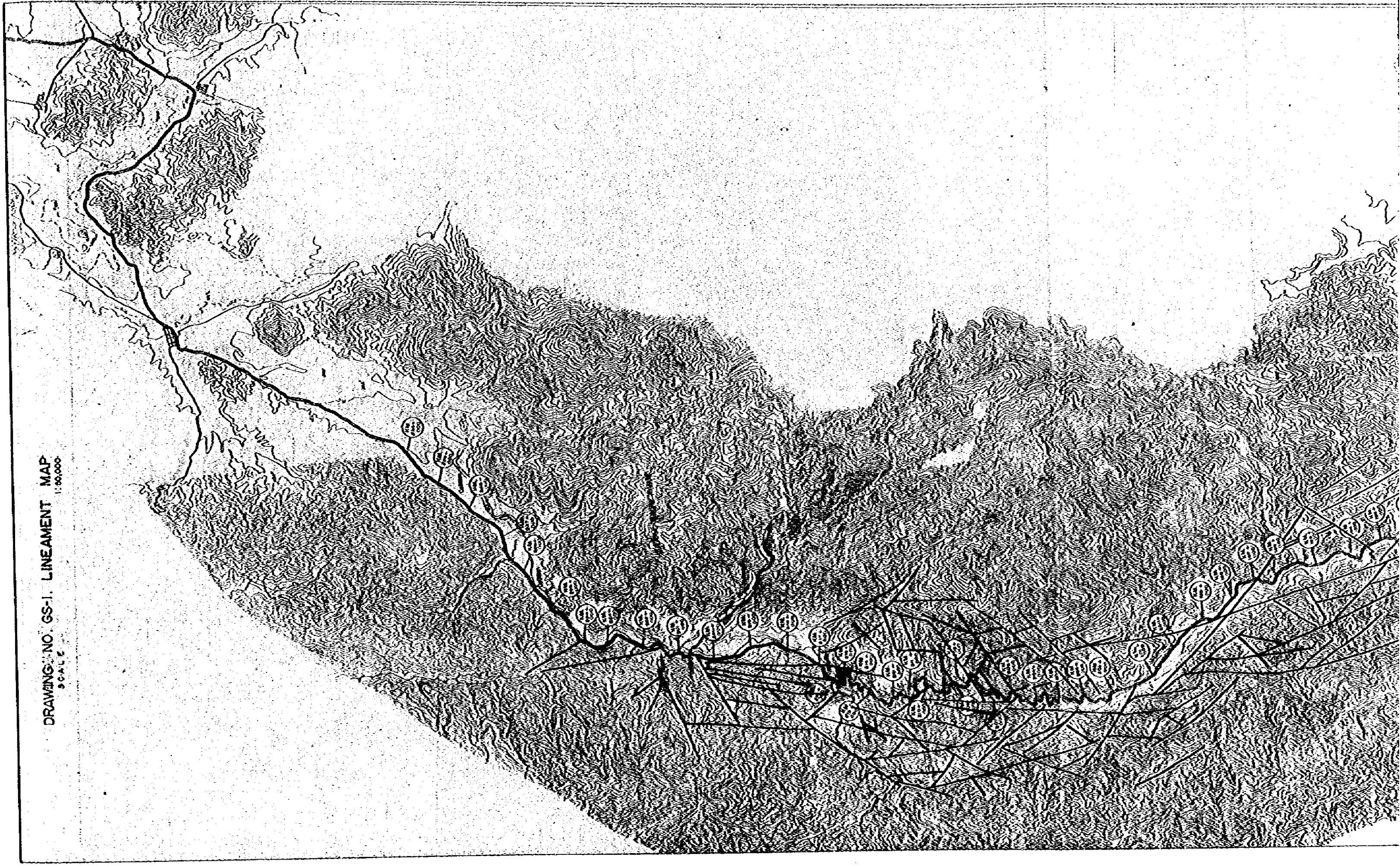

DRAWING NO. GS-1. LINEAMENT MAP  
SCALE 1:50,000



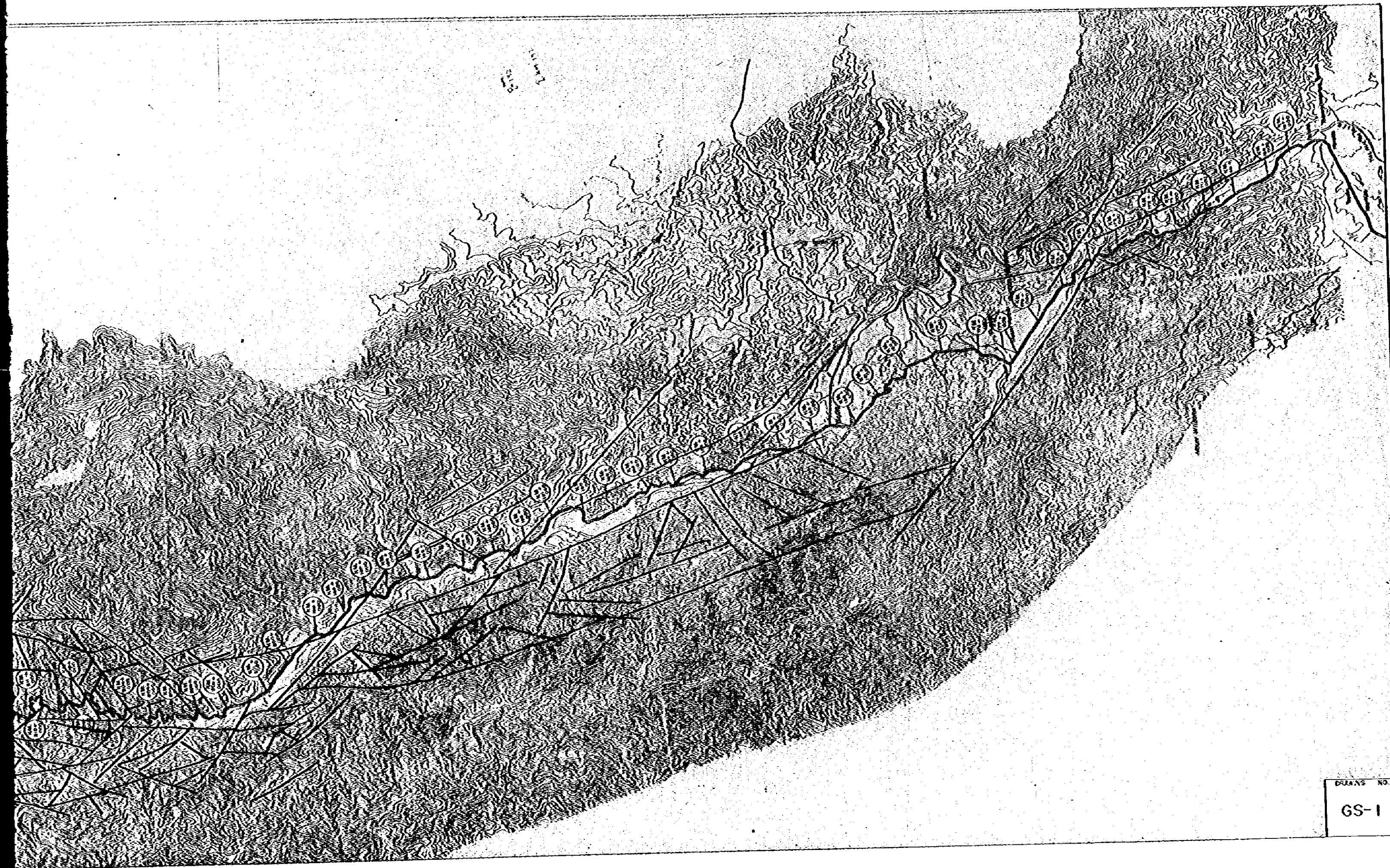

DRAWING NO.  
GS-1



DRAWING NO. GS-2 LINEAMENT MAP OF SECTION-A THE DALTON PASS TUNNEL PROJECT

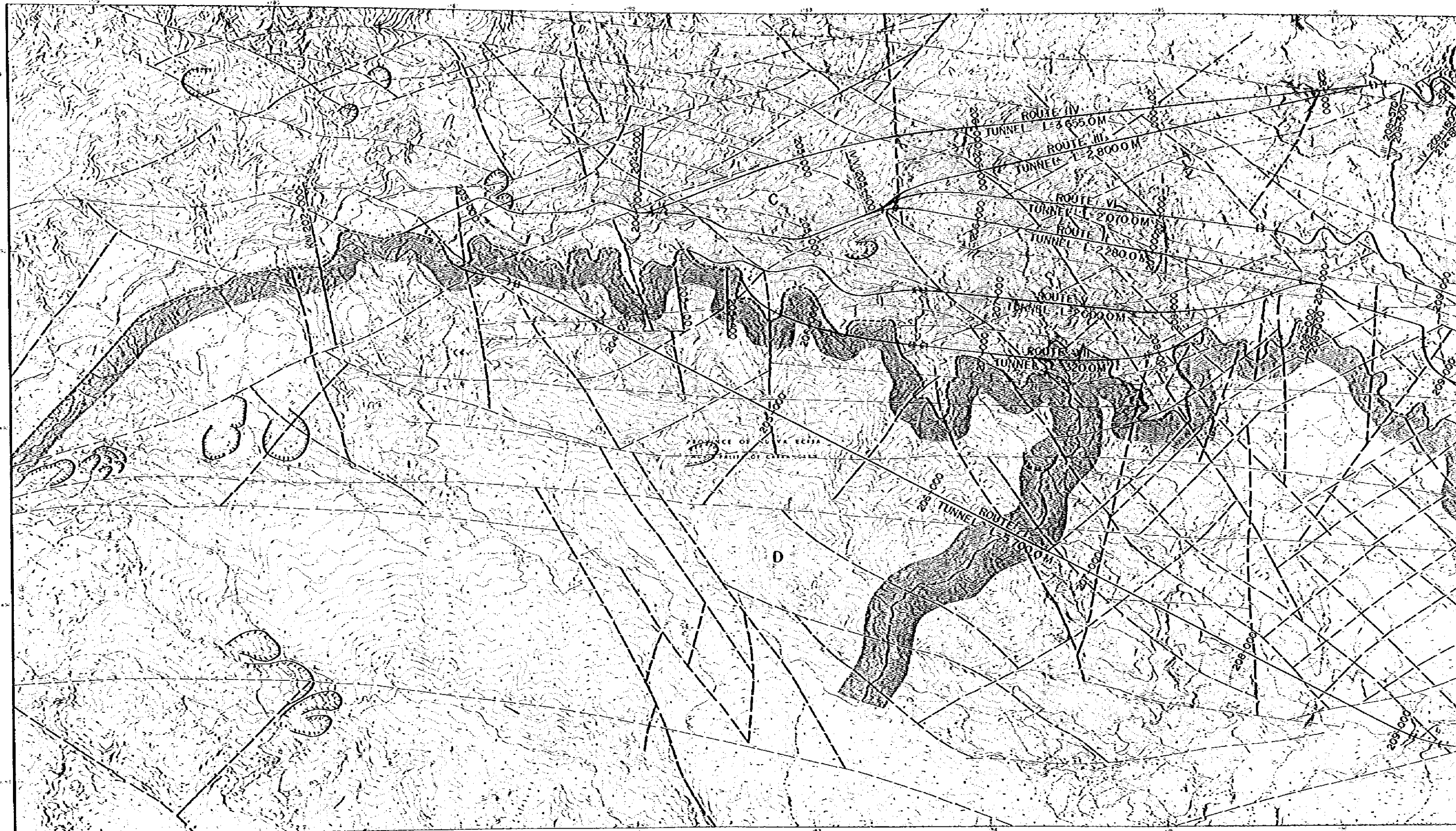

PASS TUNNEL PROJECT

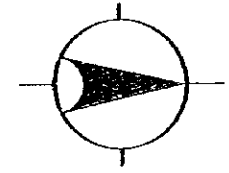
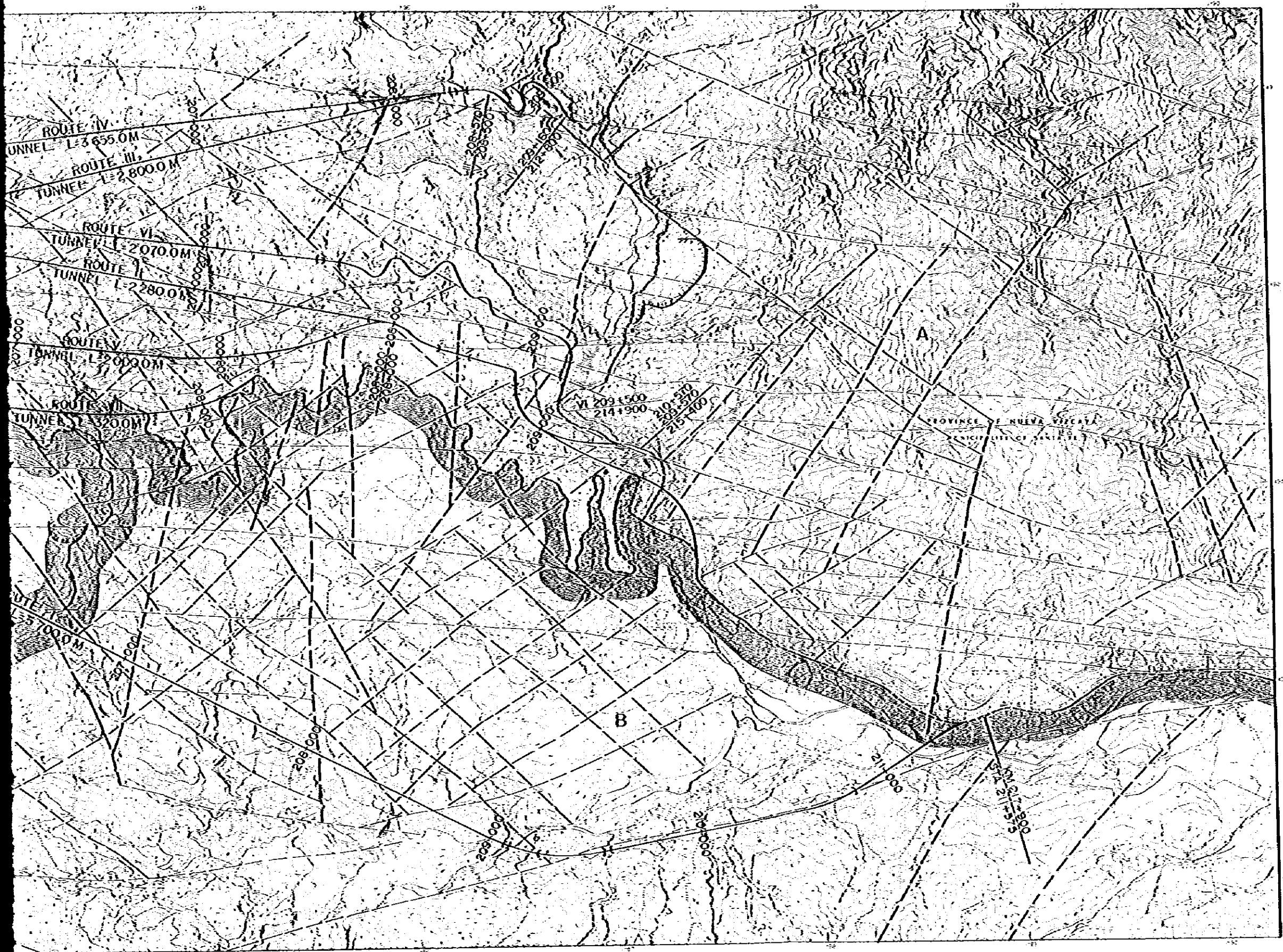

LEAGEND

- Photo Lineament
- Londslide Area

DRAWING NO.  
GS-2



DRAWING NO. GS-3 GEOLOGICAL MAP

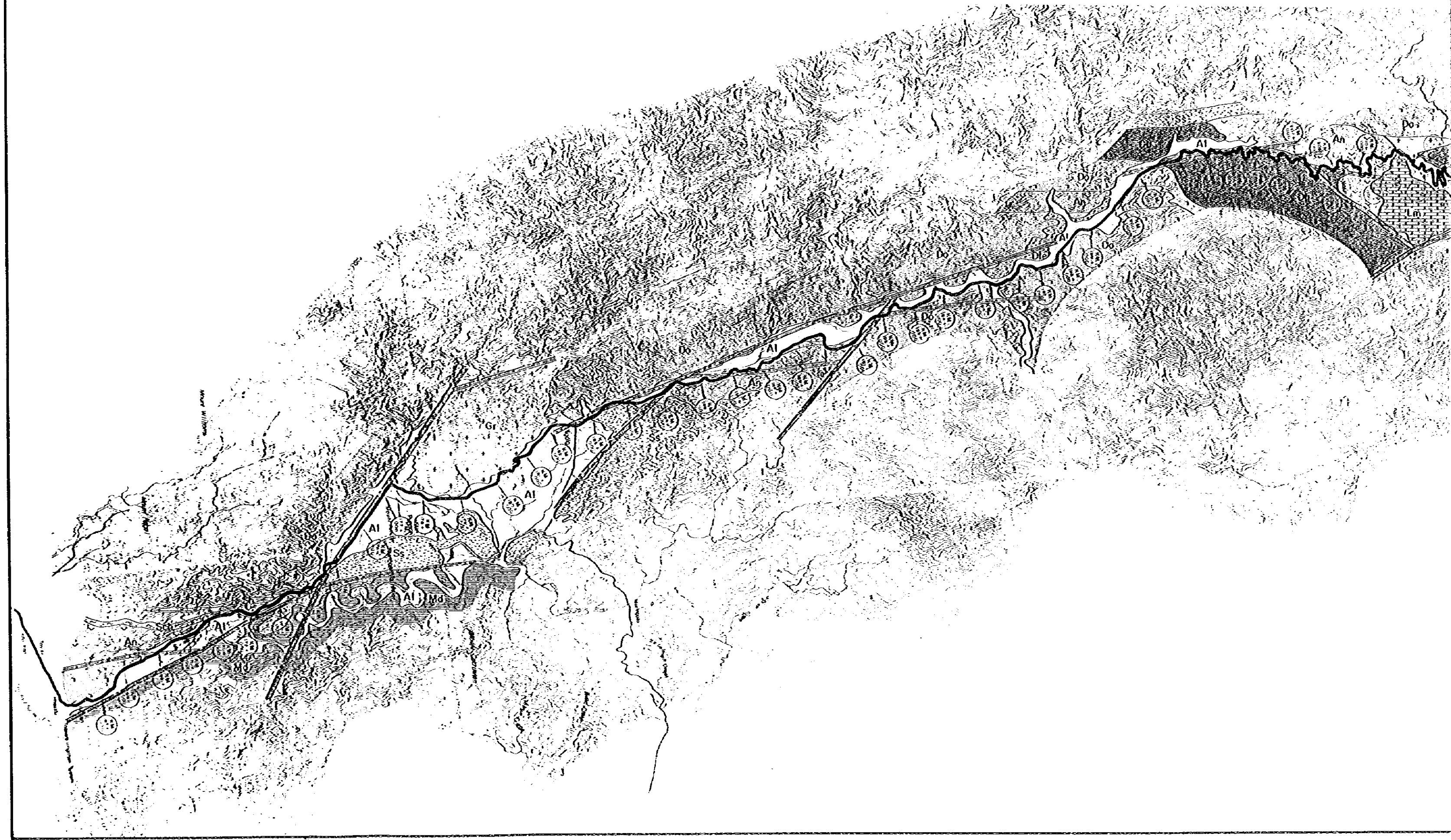

DRAWING NO. GS-3 GEOLOGICAL MAP

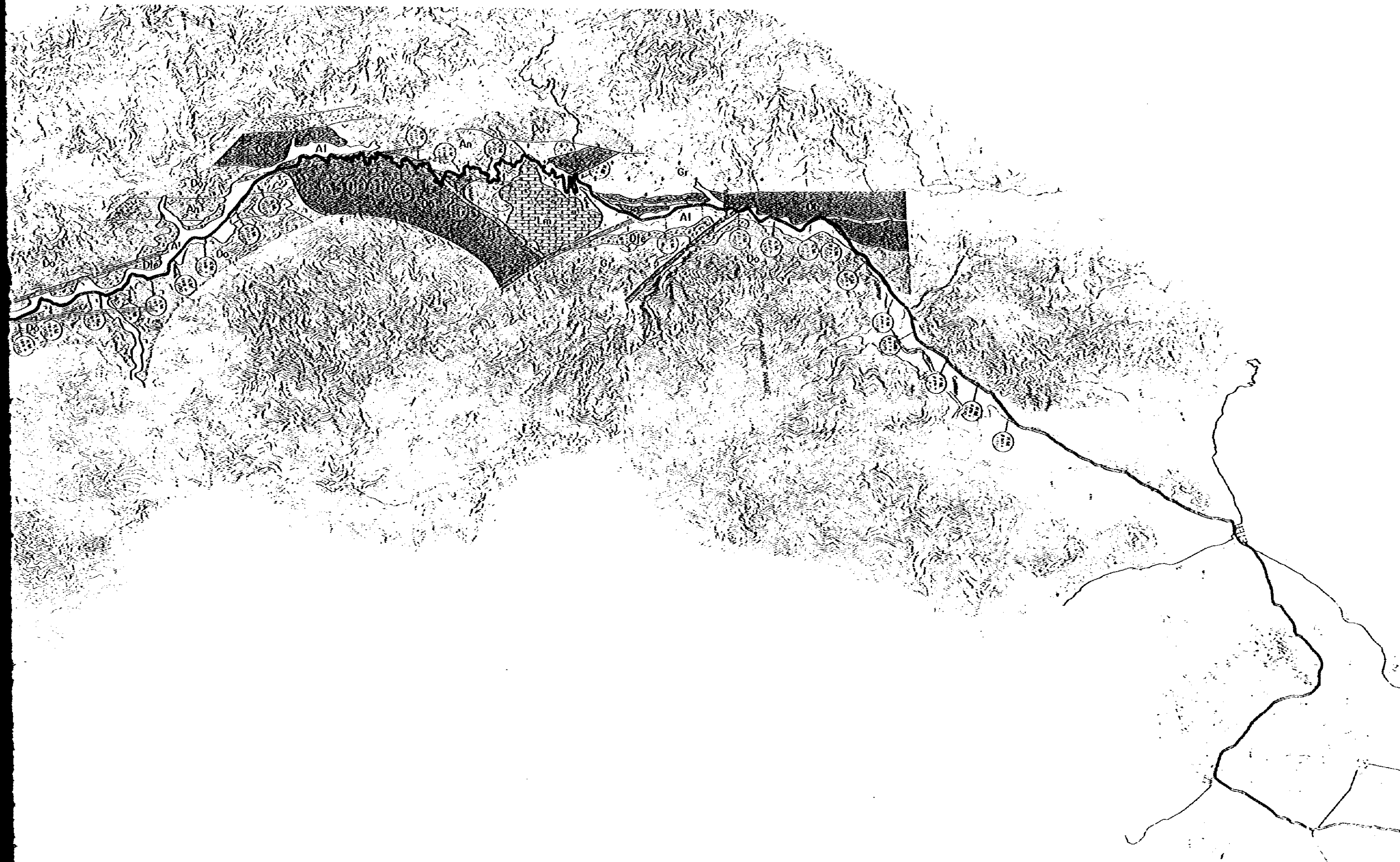

LEGEND

	Al	River Dep.
	Dte	Terrece L.
	Lm	Limestone
	Ss	Sandstone
	Md	Mudstone
	Do	Diorite
	An	Andesite
	Sh	Shale
	Db	Diobase
	Gr	Granite
	Sch	Schist
		Shear zone



GEOLOGICAL MAP



LEGEND

- Al River Deposit
- Die Terrece Deposit
- Lm Limestone
- Ss Sandstone
- Md Mudstone
- Do Diorite, Decite
- An Andesite and its pyroclastic rock
- Sh Shale
- Db Diabase and its pyroclastic rock
- Gr Granite (tonalite)
- Sch Schist
- Shear zone

DRAWING NO.  
GS-3