

FIGURES

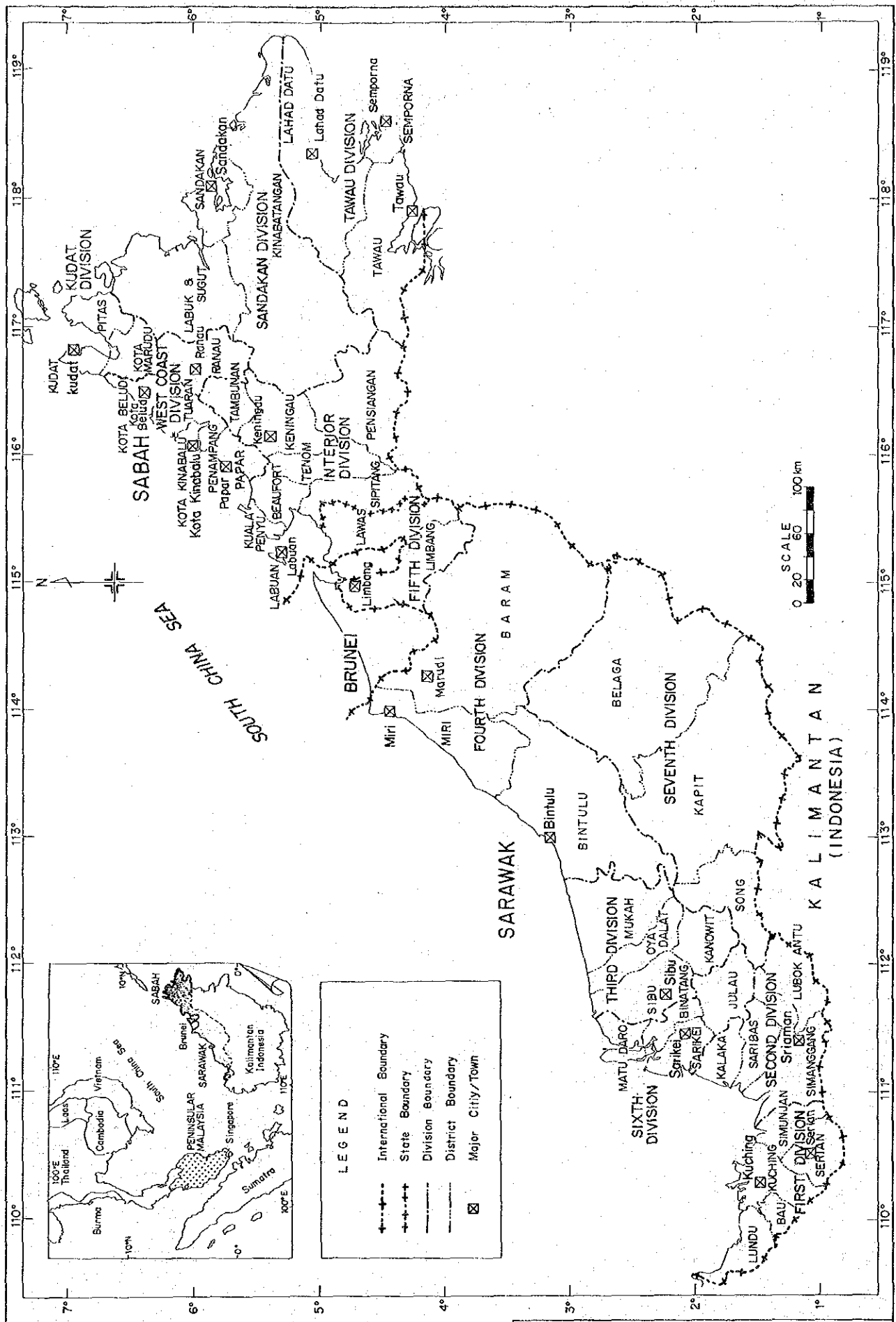

Fig. 2 Administrative Division

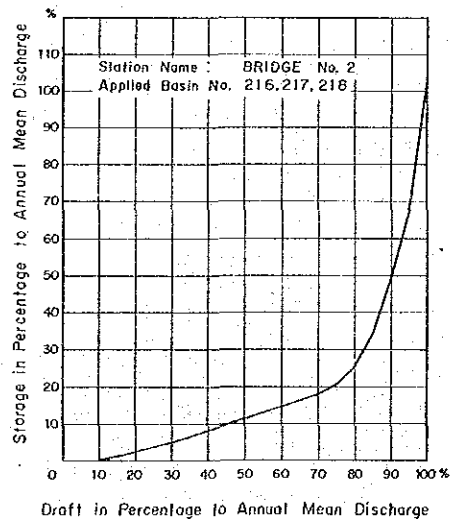
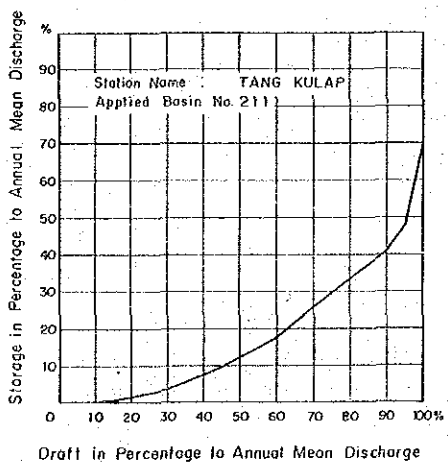
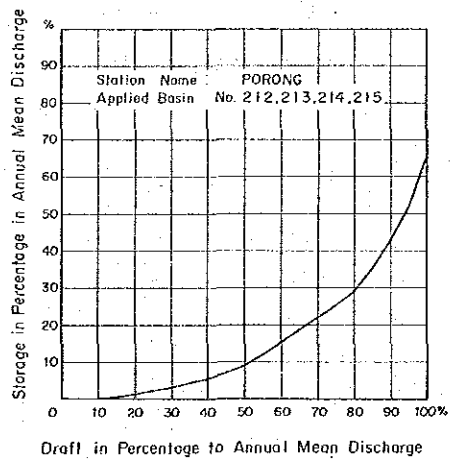
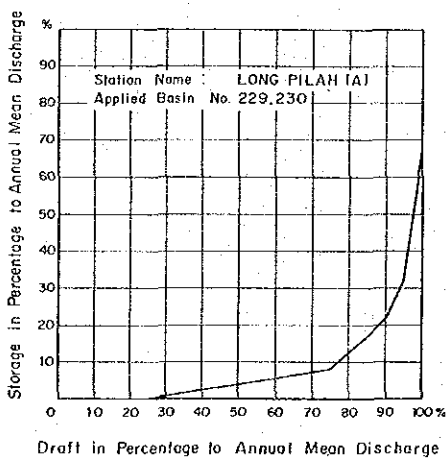
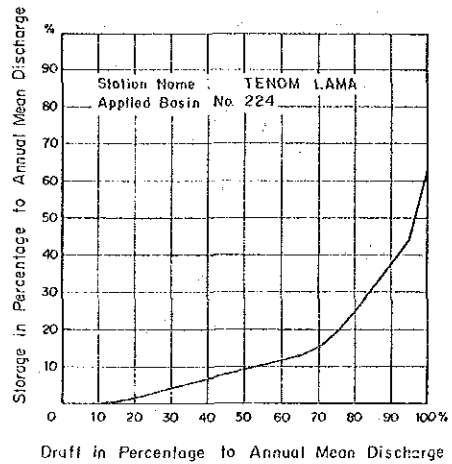
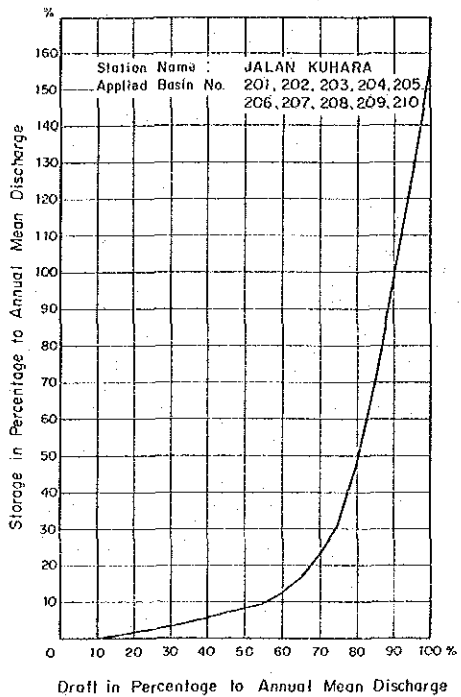

Fig. 3 Non-Dimensional Storage-Draft Curves (1/2)

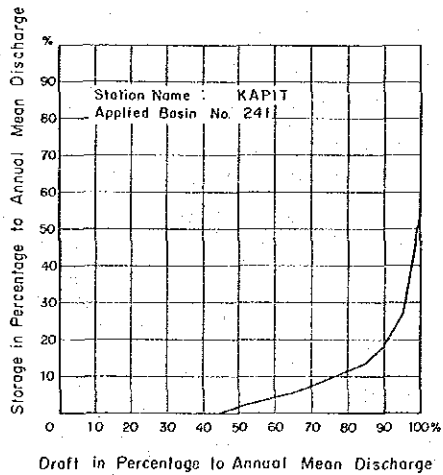
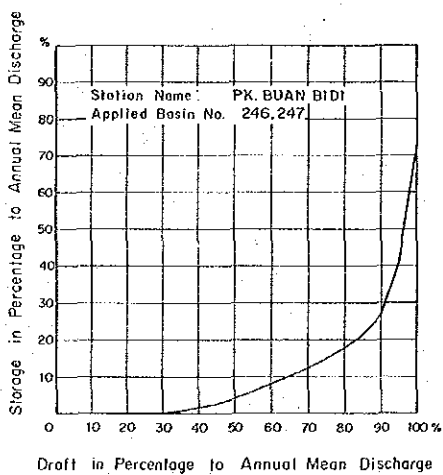
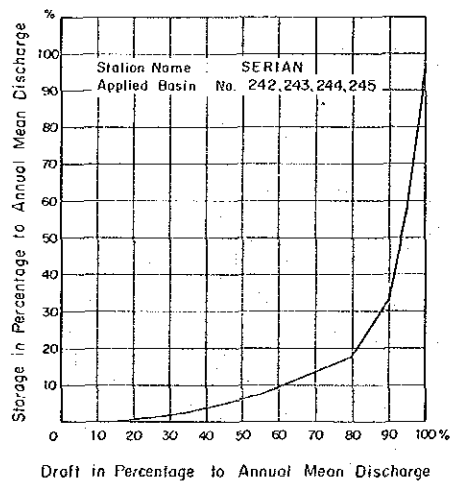
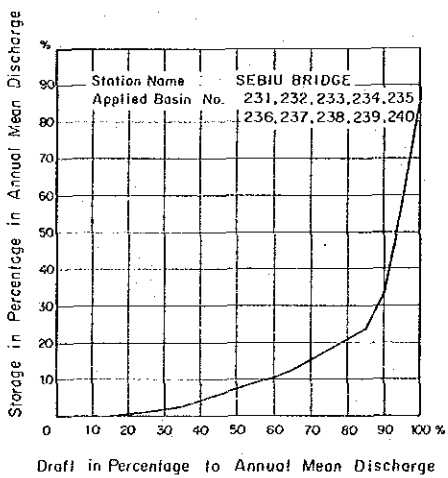
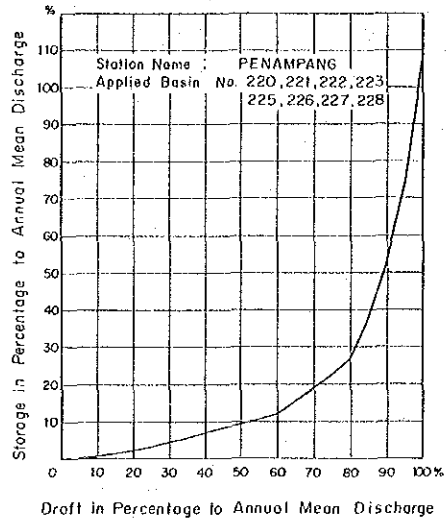
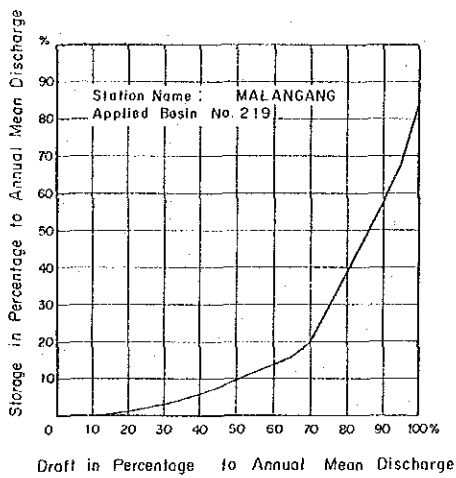

Fig. 4 Non-Dimensional Storage - Draft Curves (2/2)

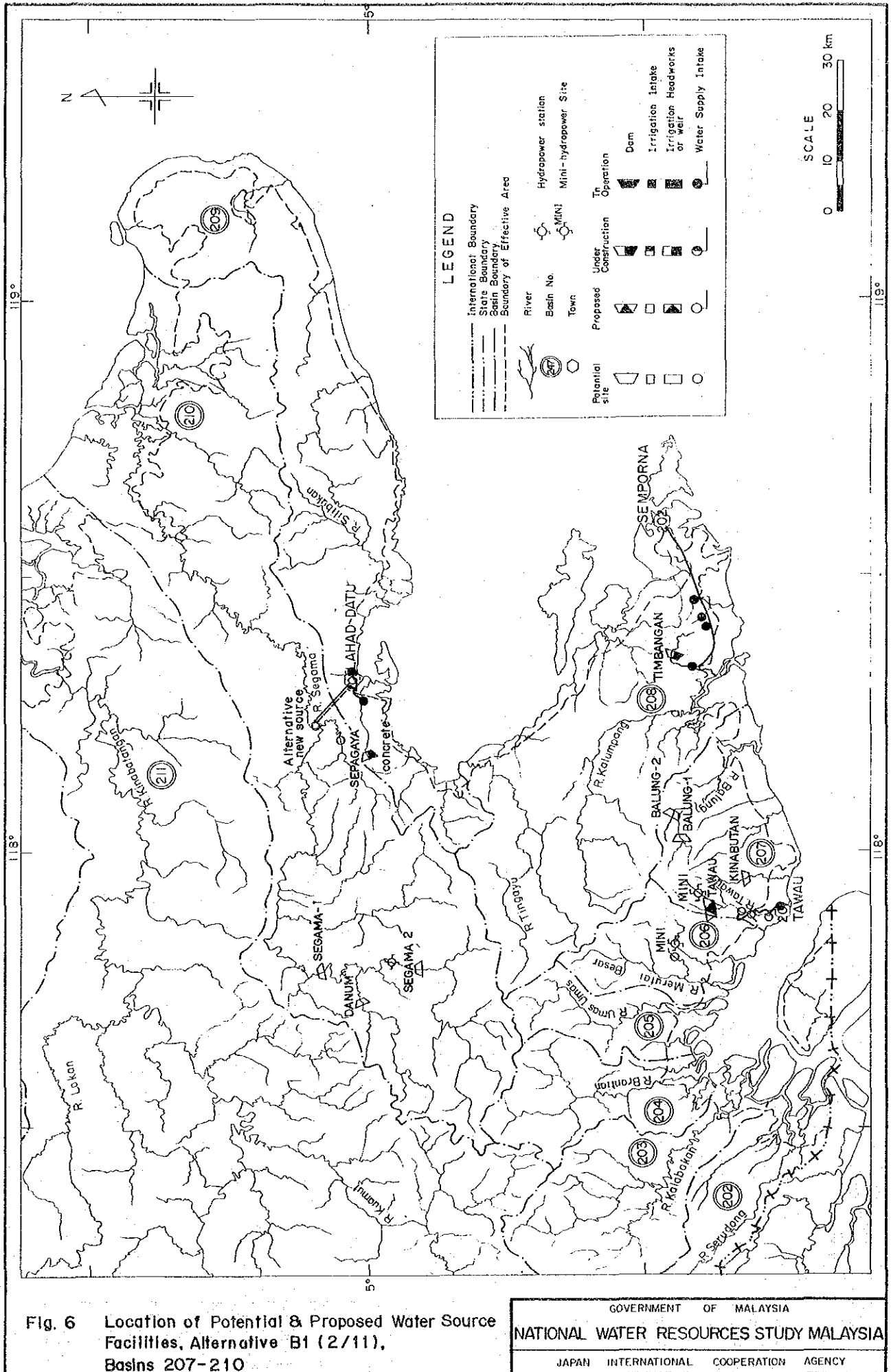

Fig. 6 Location of Potential & Proposed Water Source Facilities, Alternative B1 (2/11), Basins 207-210

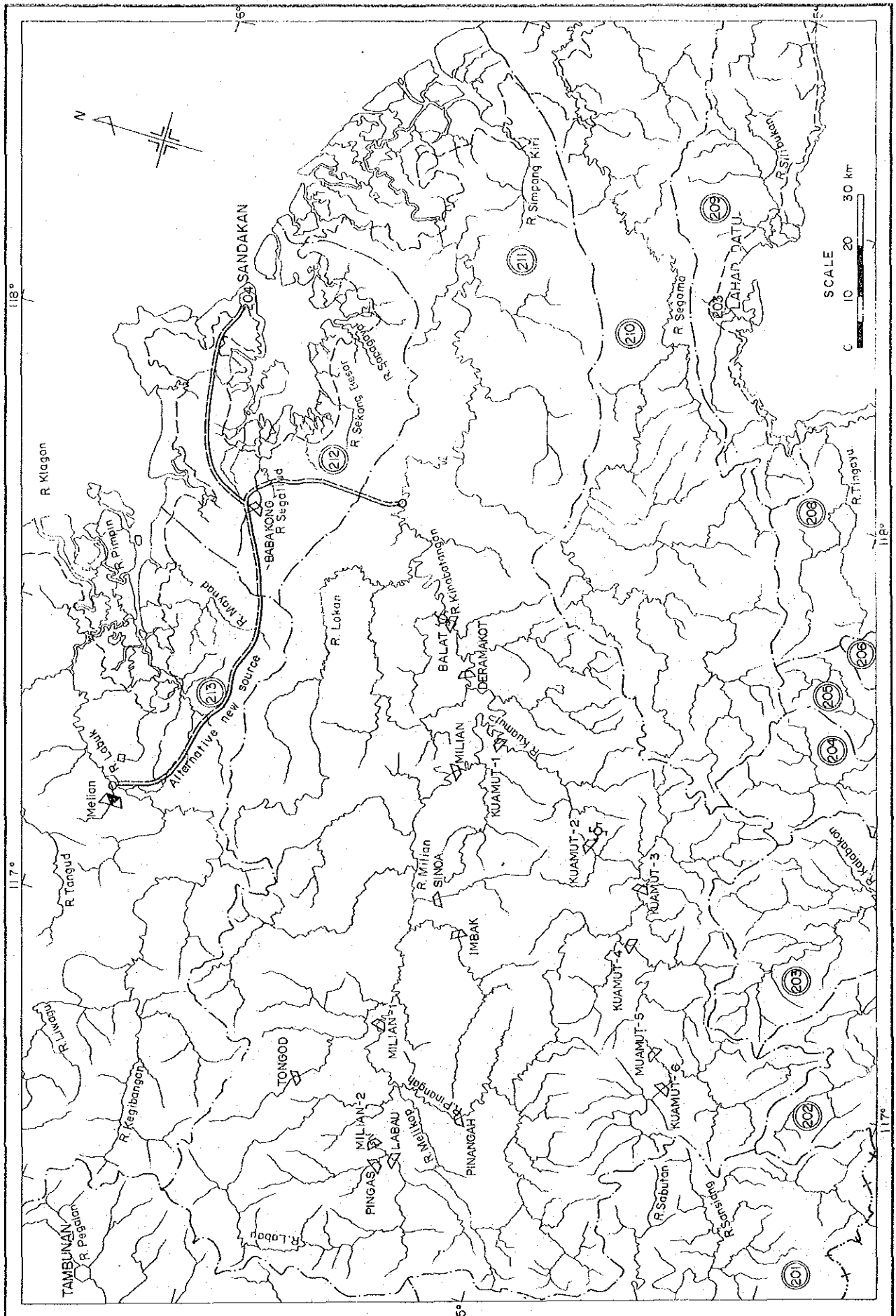

Fig. 7 Location of Potential & Proposed Water Source Facilities, Alternative B1 (3/11), Basins 211-212

GOVERNMENT OF MALAYSIA
NATIONAL WATER RESOURCES STUDY MALAYSIA
 JAPAN INTERNATIONAL COOPERATION AGENCY

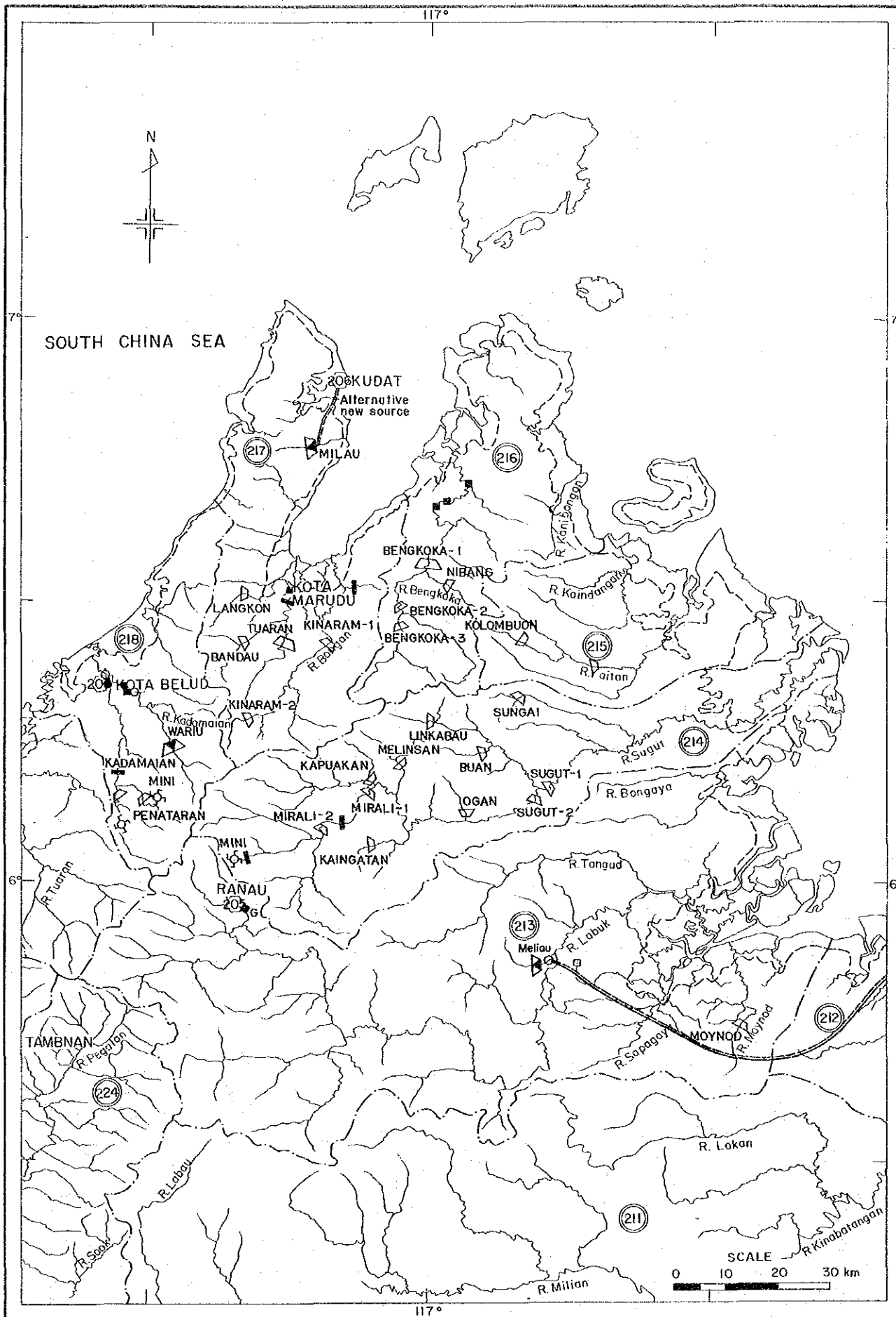

Fig. 8 Location of Potential & Proposed Water Source Facilities, Alternative B1 (4/11), Basins 213-218

GOVERNMENT OF MALAYSIA
NATIONAL WATER RESOURCES STUDY MALAYSIA
 JAPAN INTERNATIONAL COOPERATION AGENCY

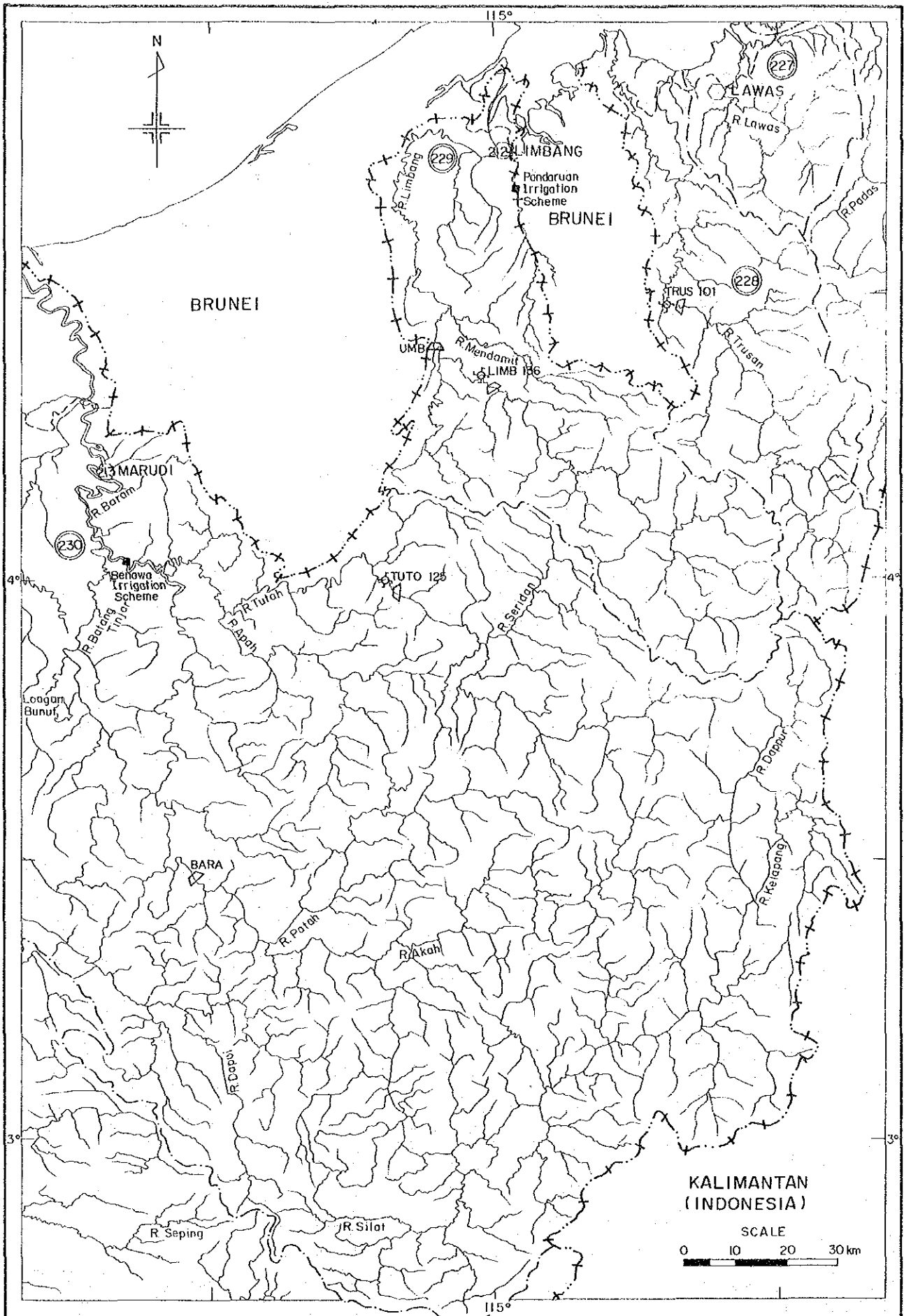

Fig. 10 Location of Potential & Proposed Water Source Facilities, Alternative B1 (6/11), Basins 227-230

GOVERNMENT OF MALAYSIA
NATIONAL WATER RESOURCES STUDY MALAYSIA
 JAPAN INTERNATIONAL COOPERATION AGENCY

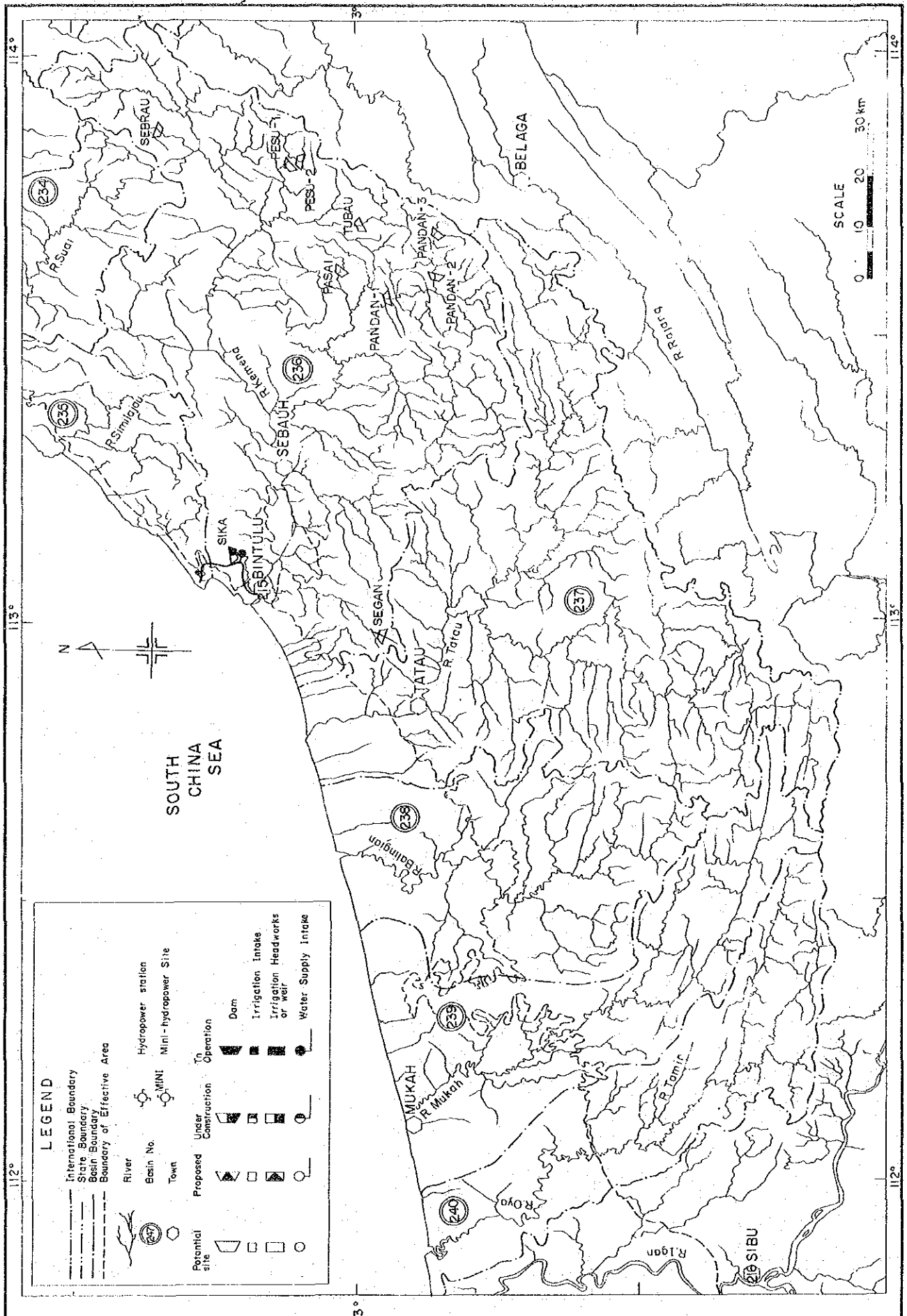

Fig. 12 Location of Potential & Proposed Water Source Facilities, Alternative B1 (8/11), Basins 236-240

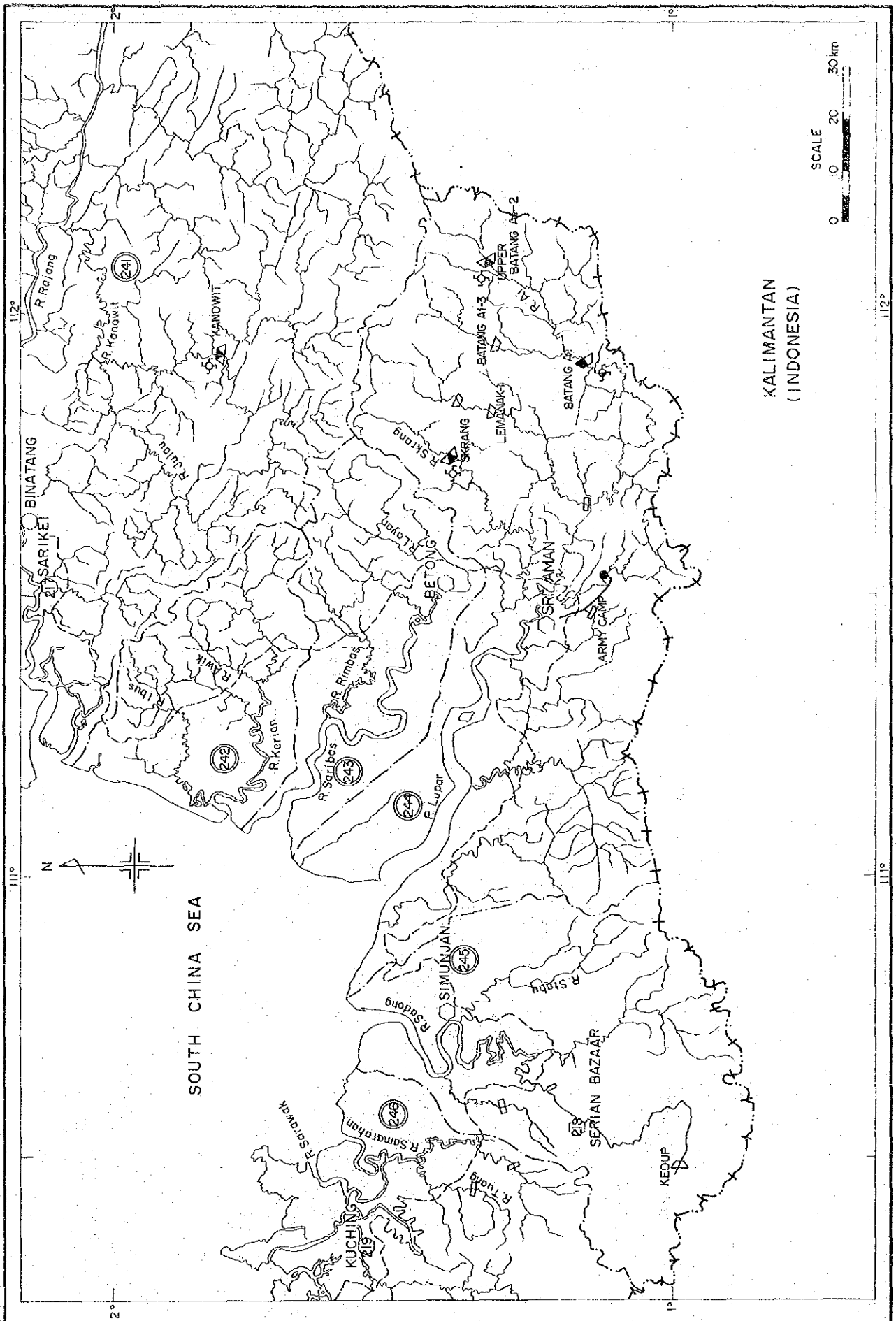

Fig. 14 Location of Potential & Proposed Water Source Facilities, Alternative B1 (10/11), Basins 242-244

GOVERNMENT OF MALAYSIA
NATIONAL WATER RESOURCES STUDY MALAYSIA
 JAPAN INTERNATIONAL COOPERATION AGENCY

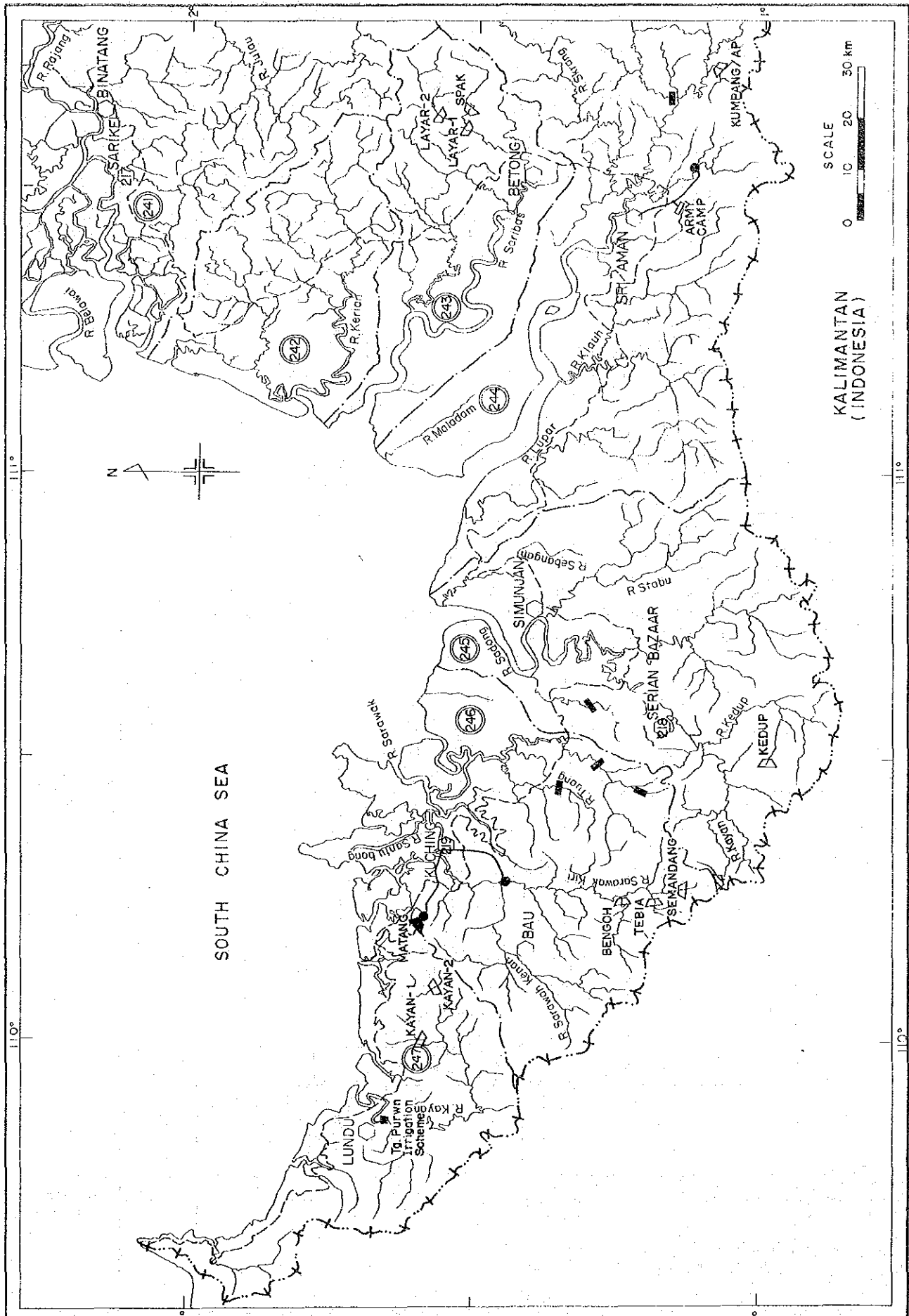

Fig. 15 Location of Potential & Proposed Water Source Facilities, Alternative B1 (11/11), Basins 245-247

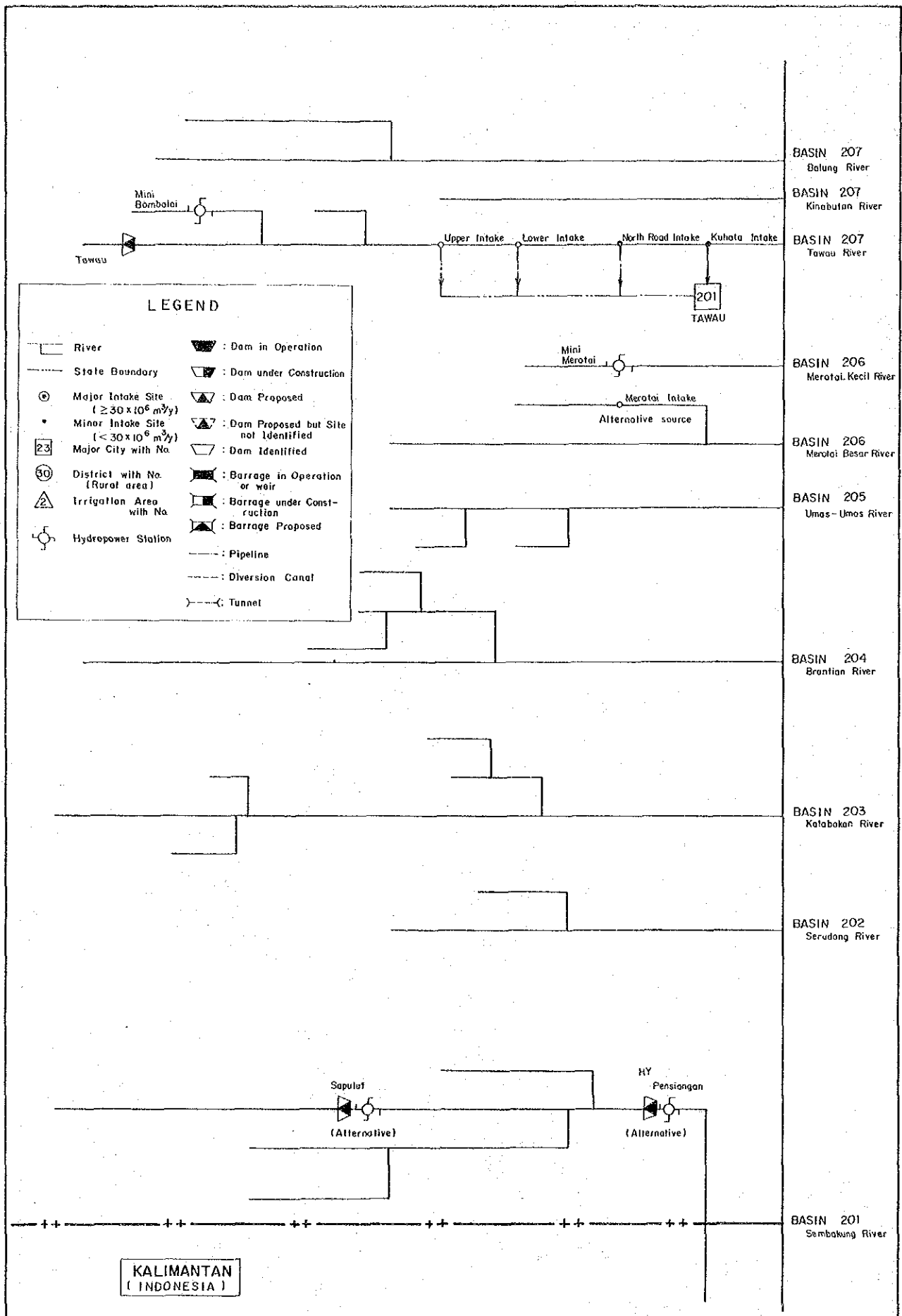

Fig. 16 Water Demand and Supply System Diagram, Basins 201~207 in Sabah, Alternative BI & Recommended Plan

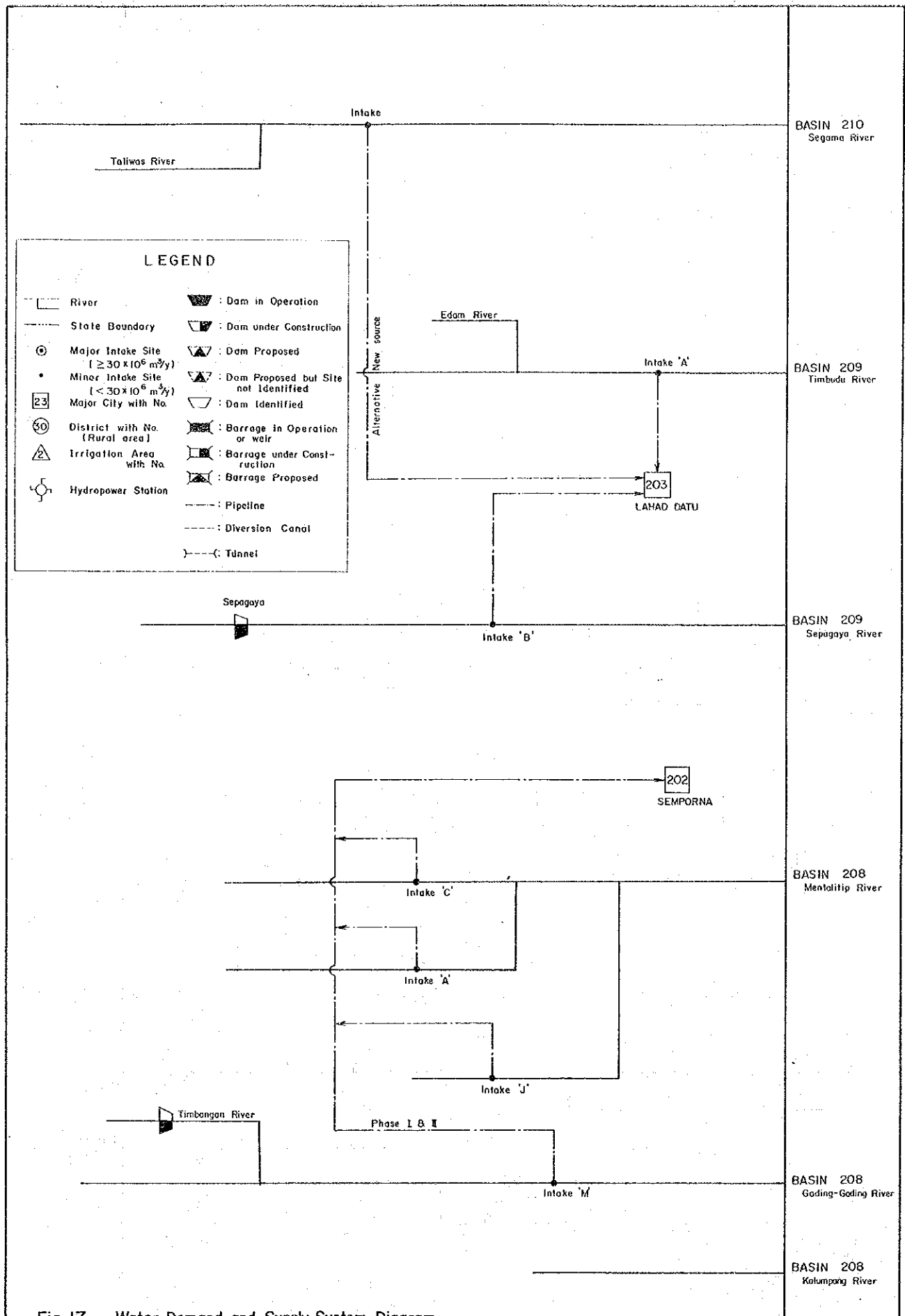

Fig. 17 Water Demand and Supply System Diagram,
Basins 208~210 in Sabah,
Alternative BI & Recommended Plan

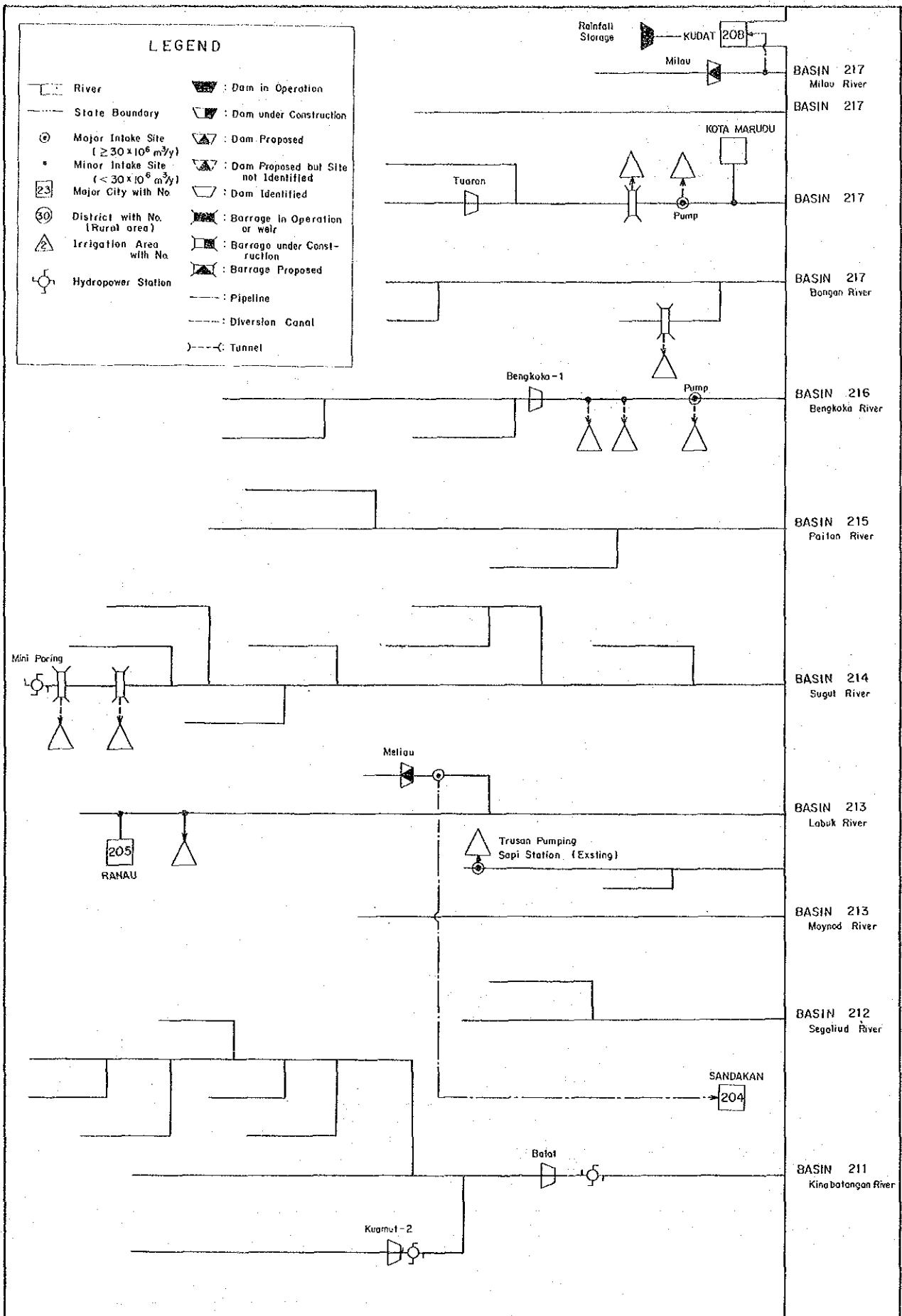

Fig.18 Water Demand and Supply System Diagram,
Basins 211~217 in Sabah,
Alternative B1 & Recommended Plan

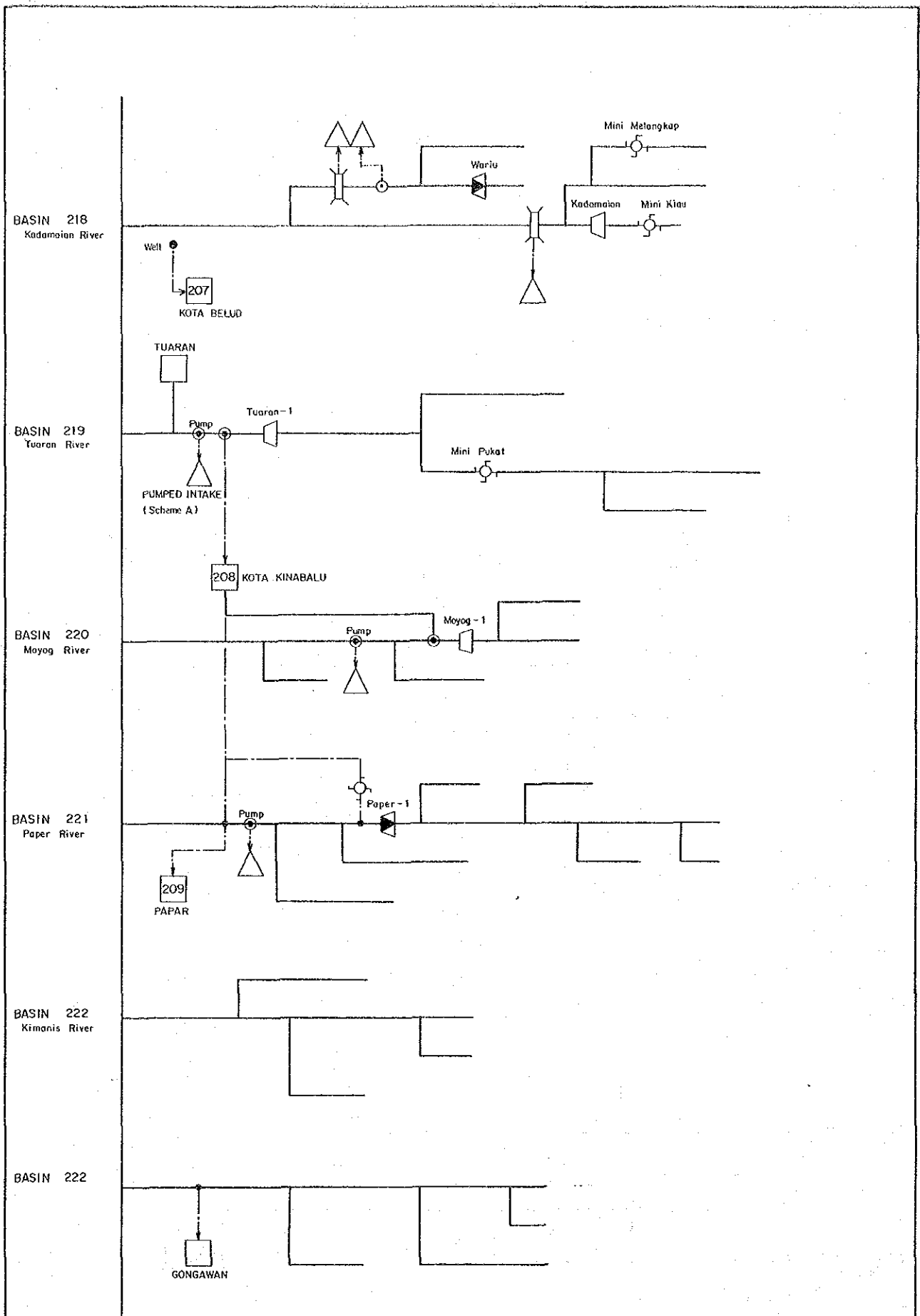

Fig.19 Water Demand Supply System Diagram,
Basins 218~222 in Sabah,
Alternative B1 & Recommended Plan

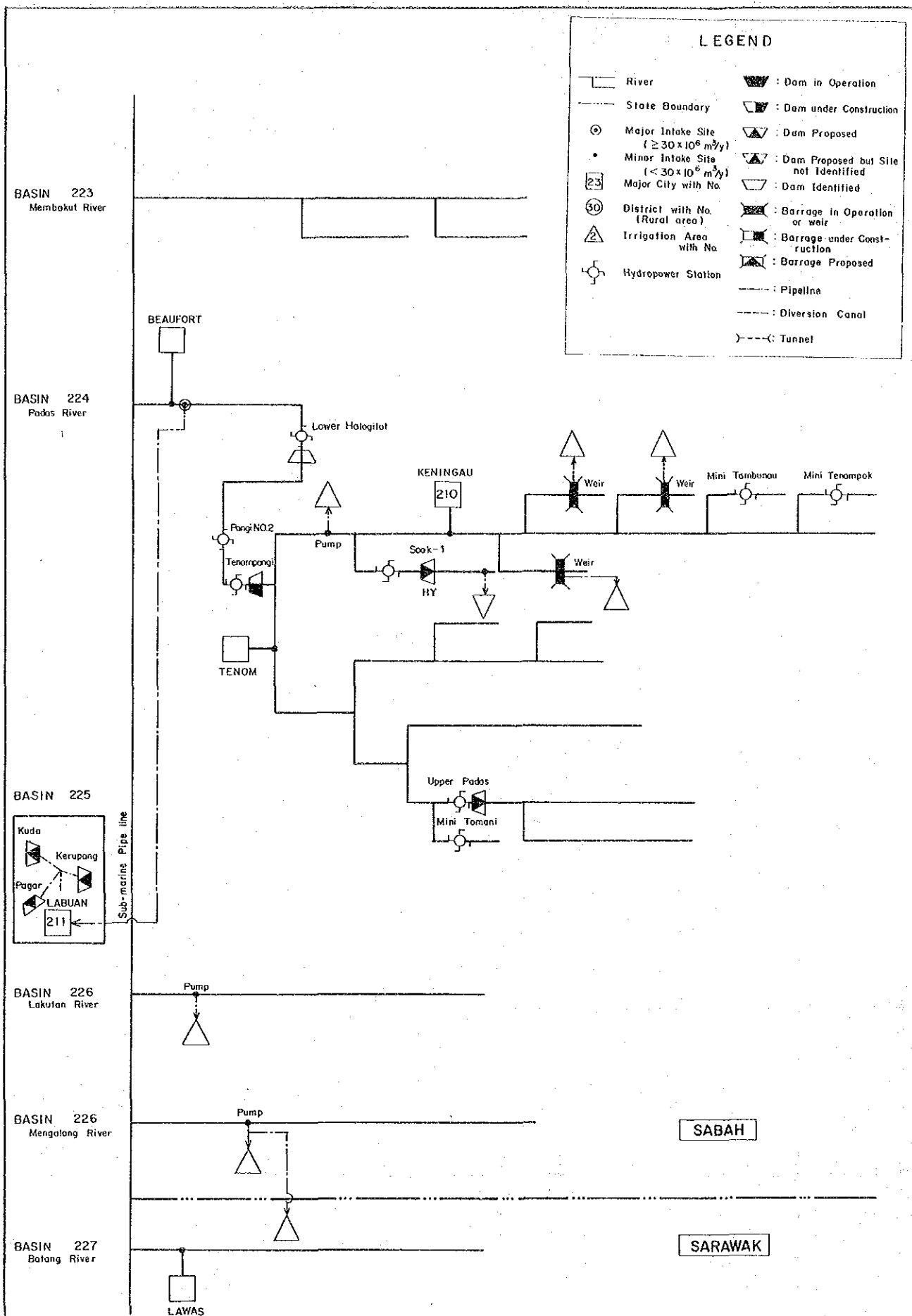
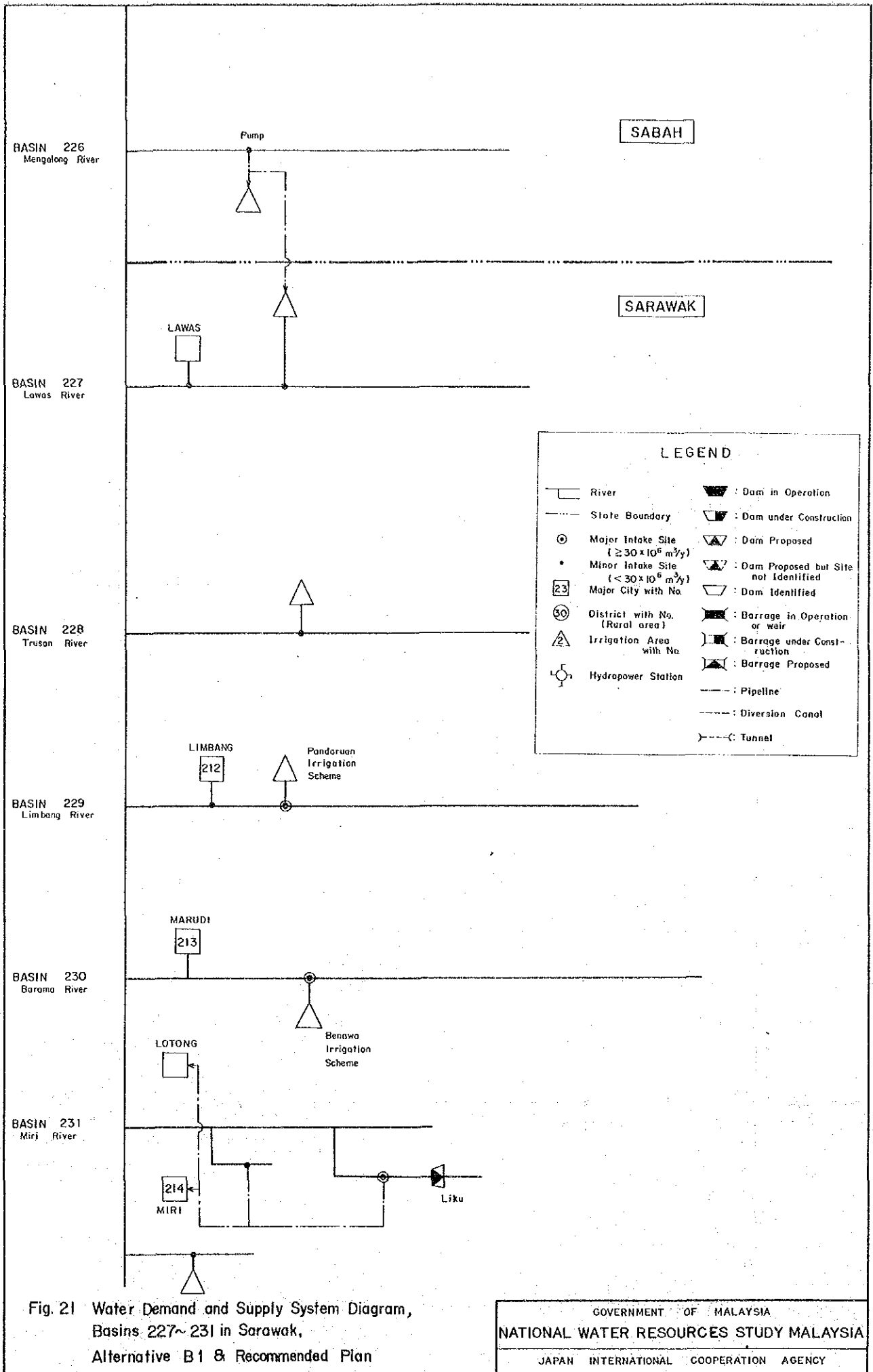

Fig. 20 Water Demand and Supply System Diagram, Basins 223~227 in Sabah, Alternative B1 & Recommended Plan



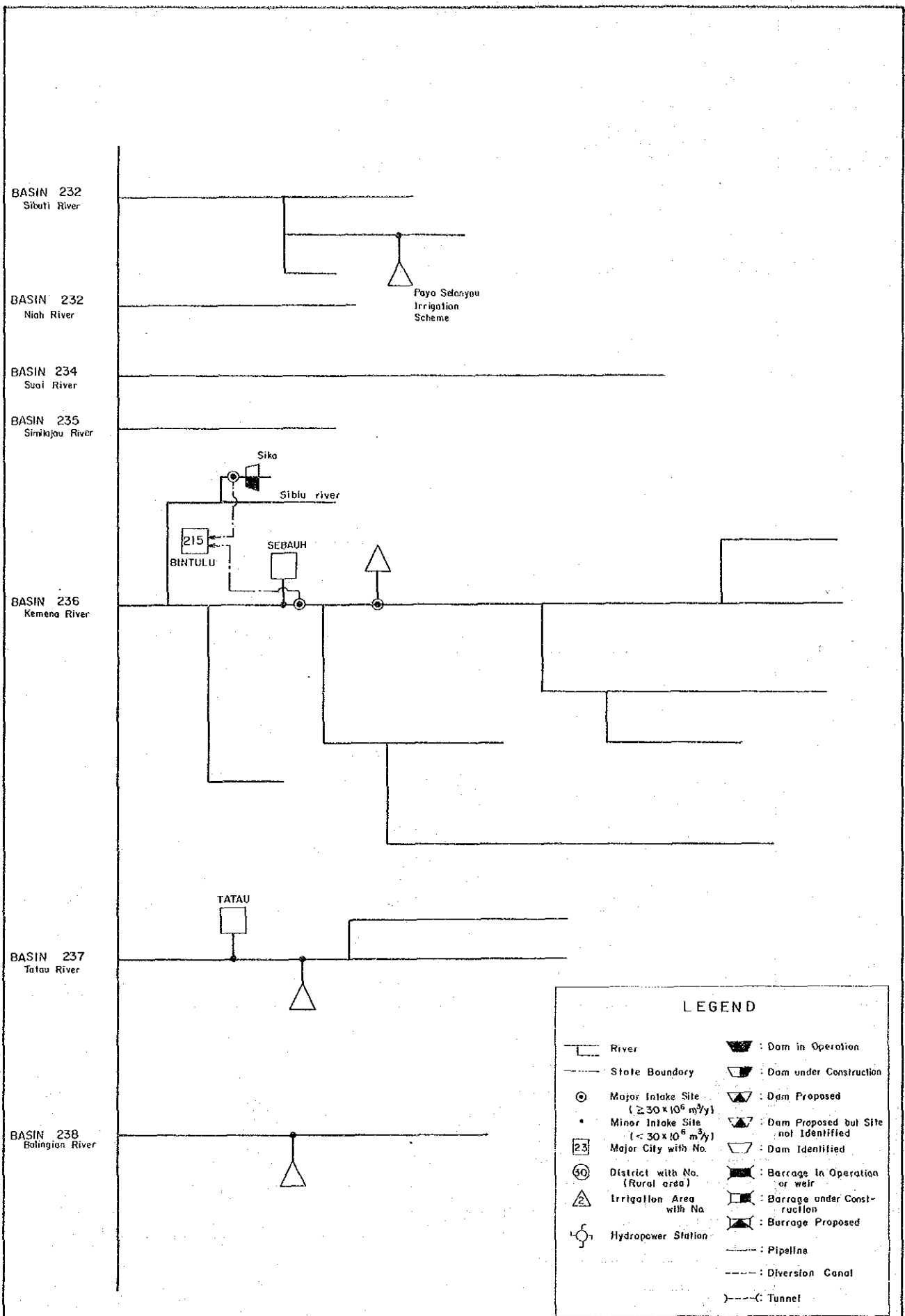

Fig. 22 Water Demand and Supply System Diagram, Basins 232~238 in Sarawak, Alternative BI & Recommended Plan

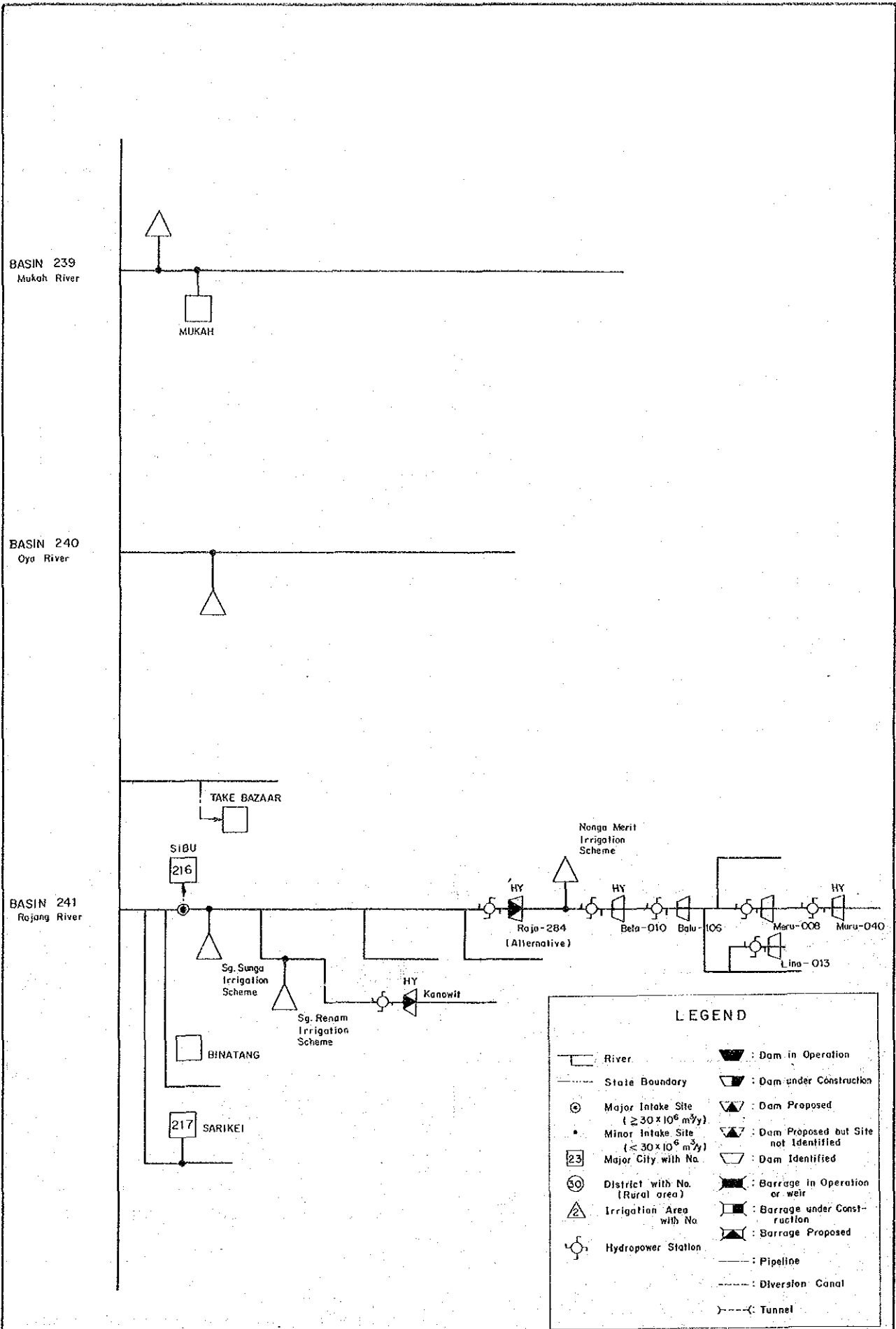

Fig. 23 Water Demand and Supply System Diagram
Basins 239~241 in Sarawak,
Alternative BI & Recommended Plan

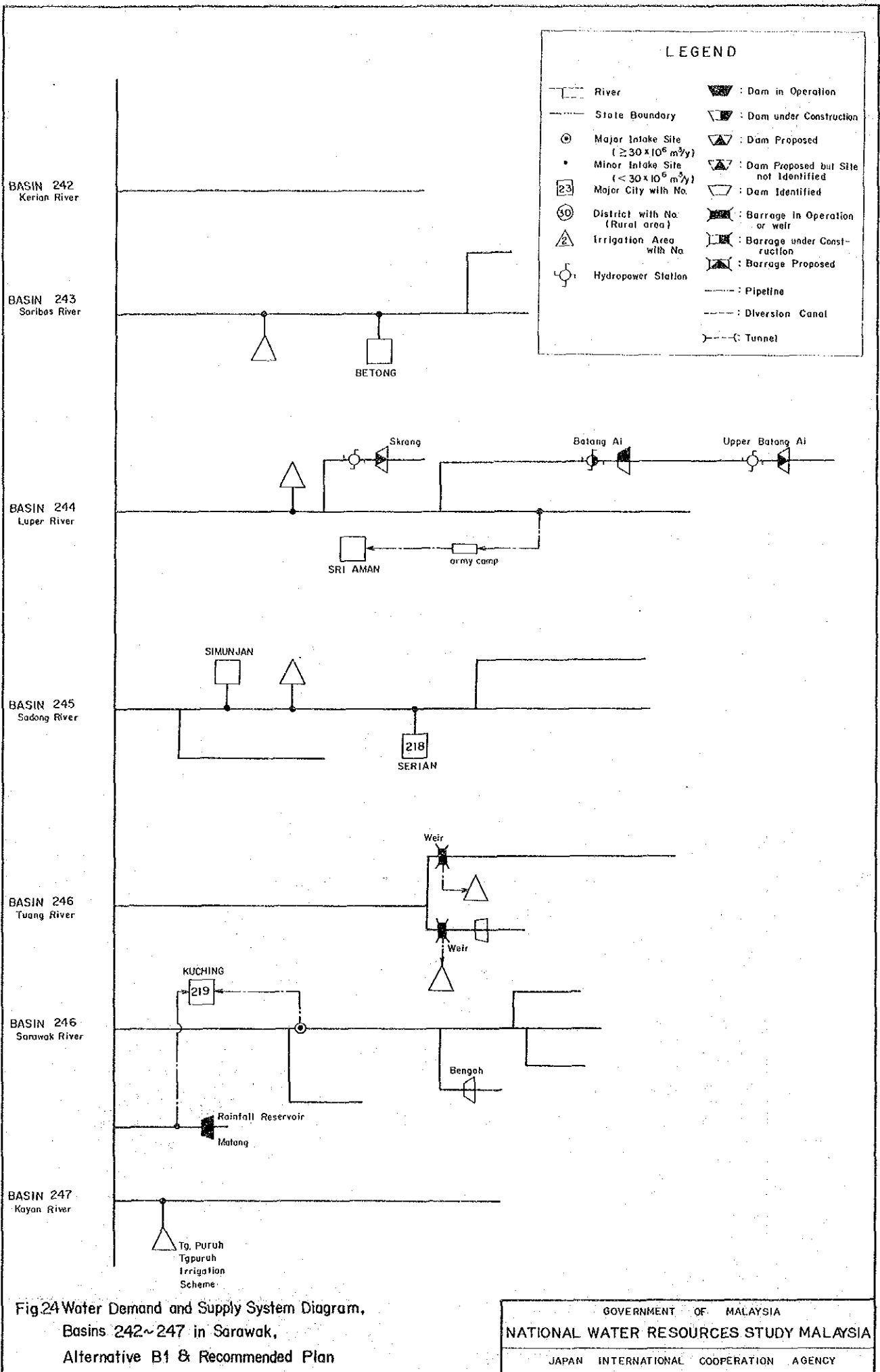

Fig.24 Water Demand and Supply System Diagram,
Basins 242~247 in Sarawak,
Alternative B1 & Recommended Plan

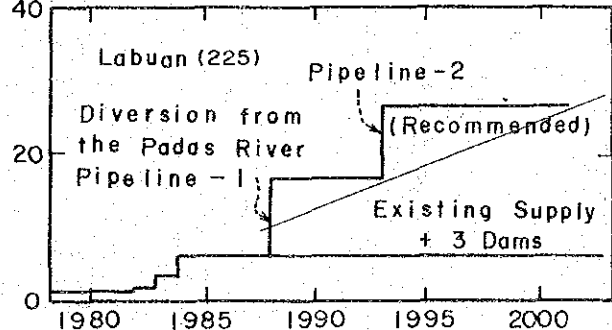
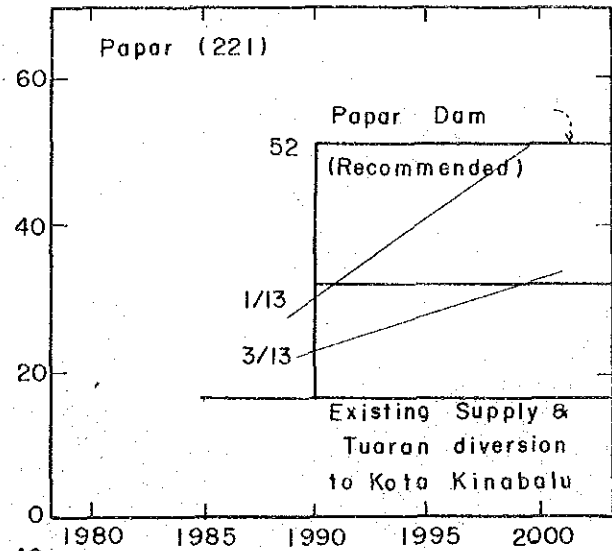
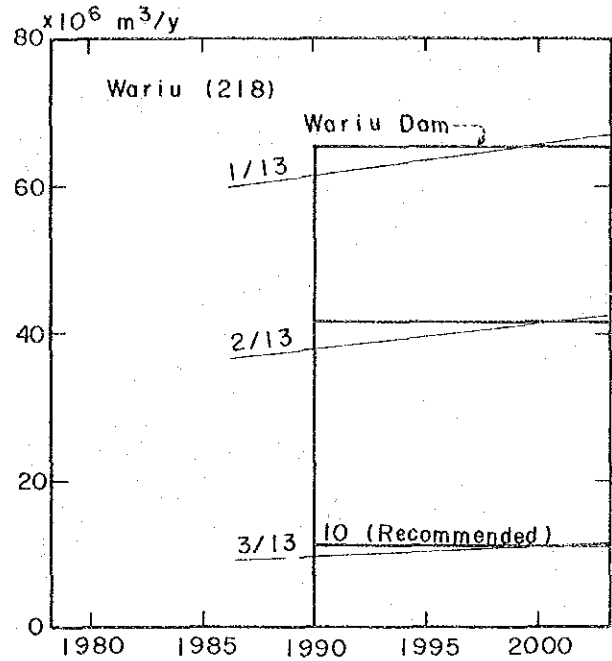
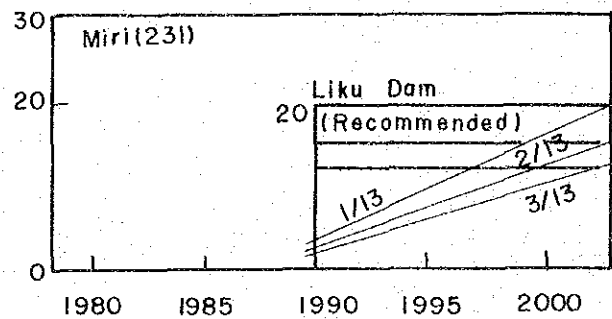
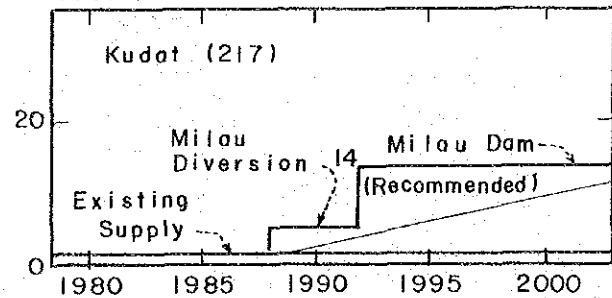
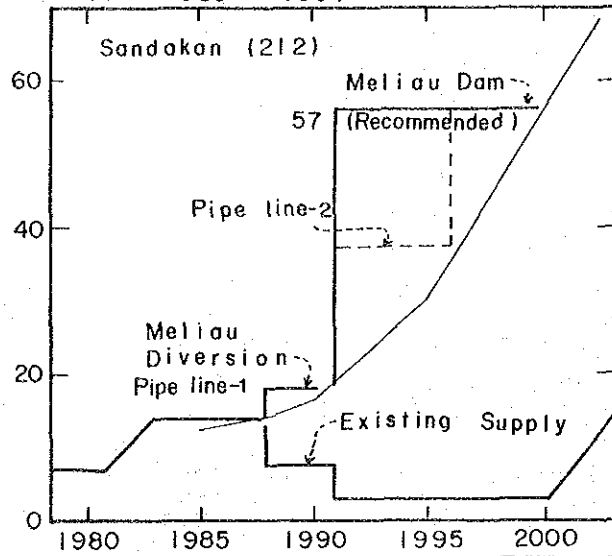
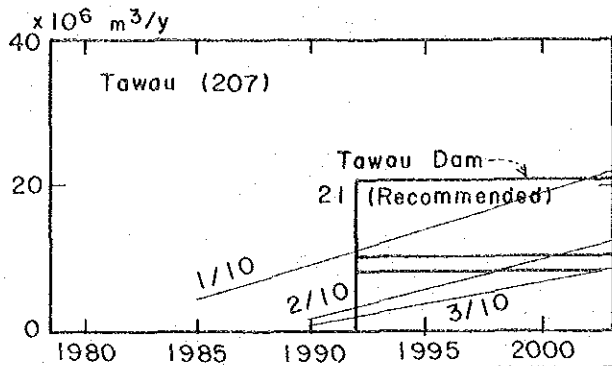

Fig.25 Recommended Water Demand and Supply Balance Program

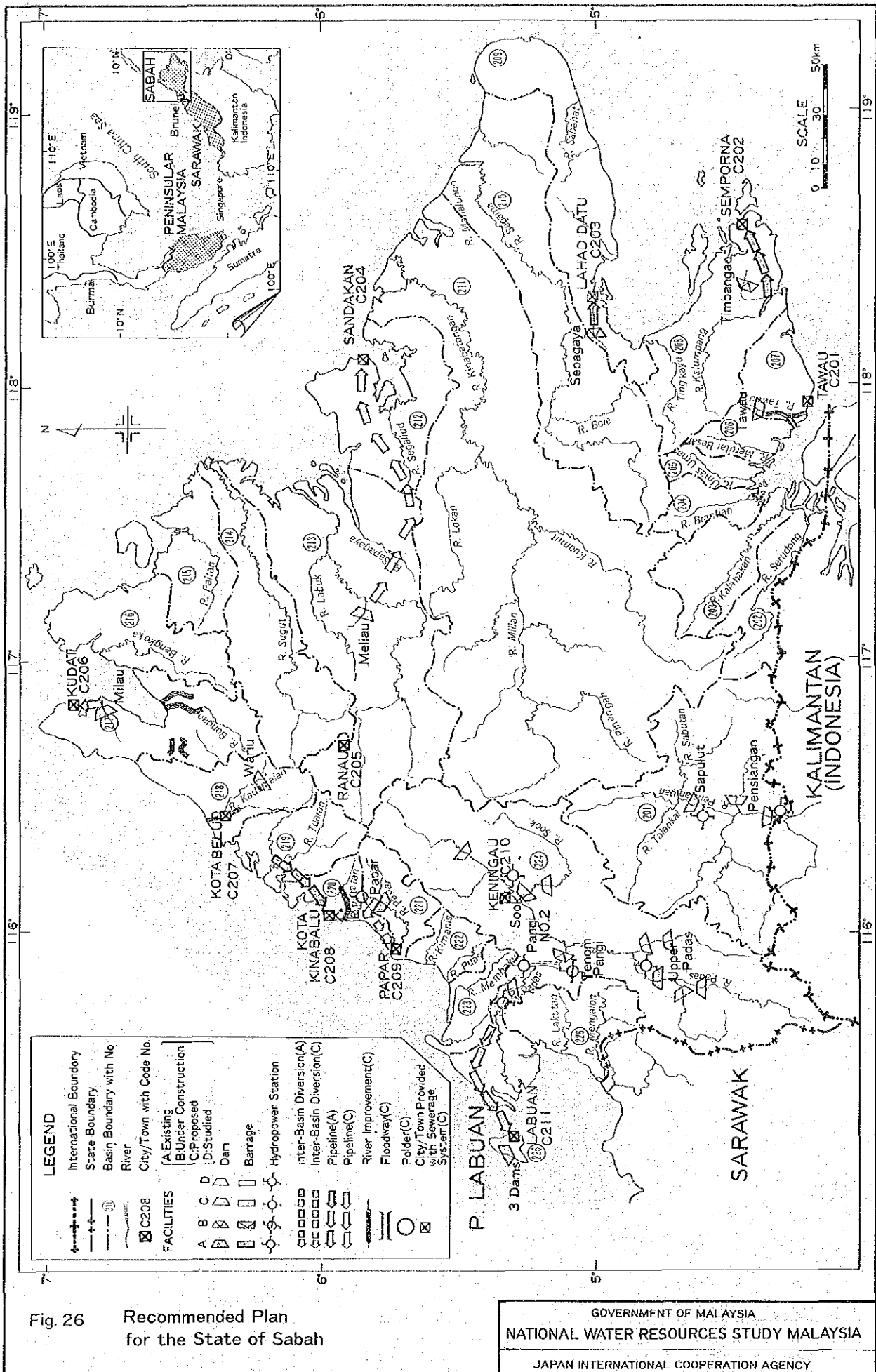

Fig. 26 Recommended Plan for the State of Sabah

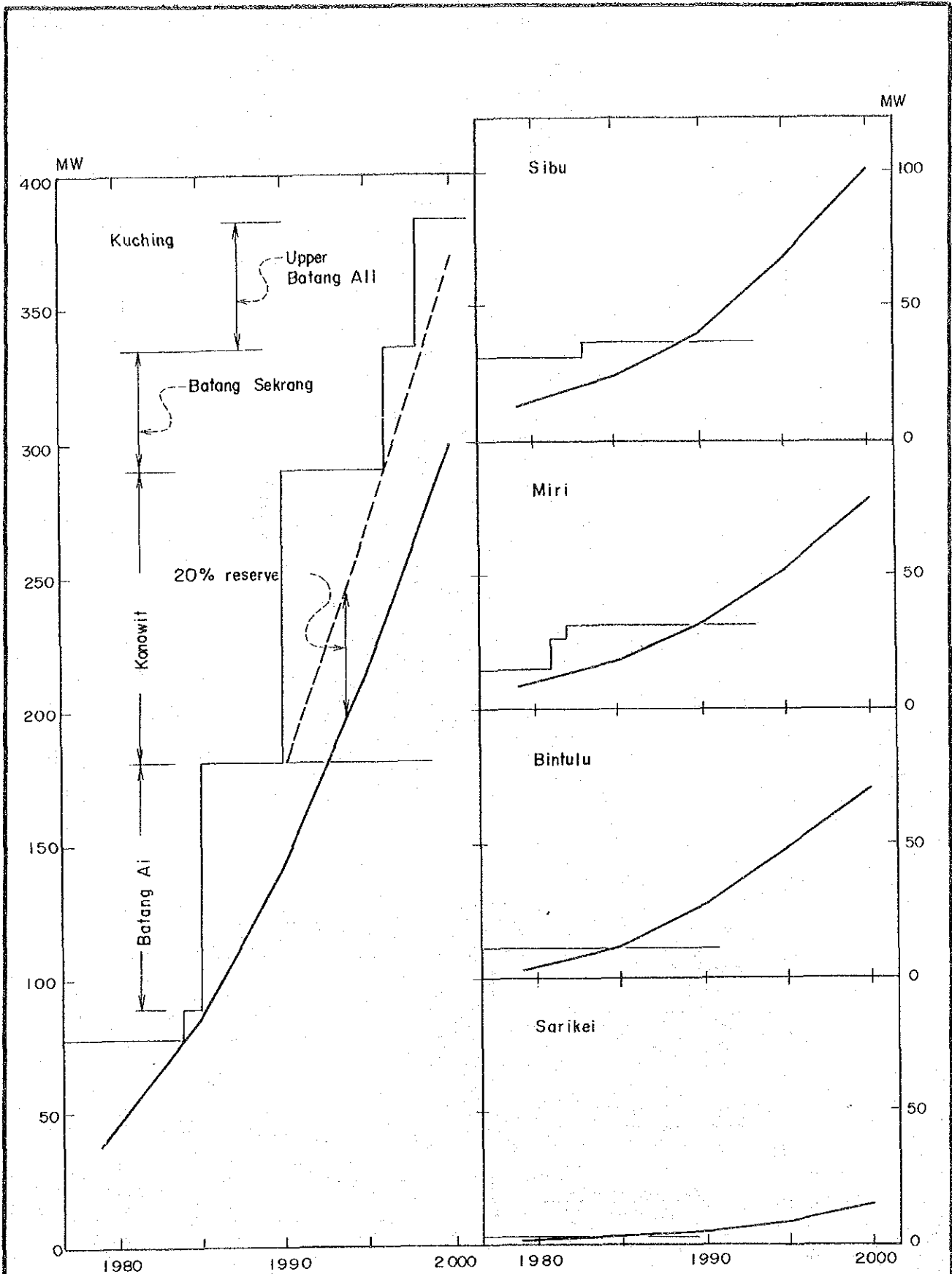

Fig 28 Power Balance at Major Power Stations in Sarawak

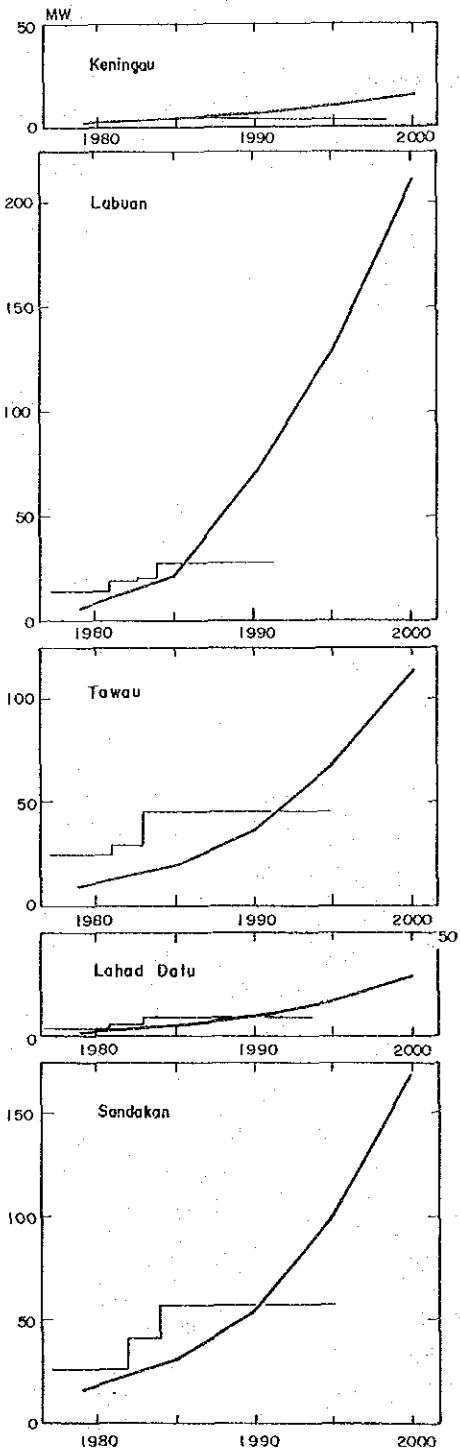
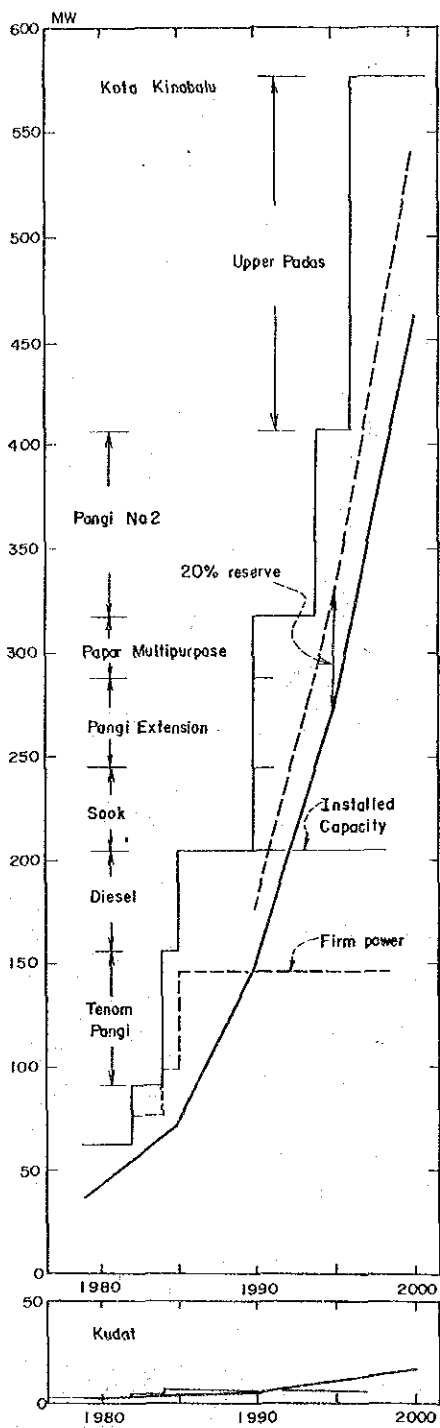

Fig.29 Power Balance at Major Power Stations in Sabah

