

Apex. 6 X-ray Diffraction Chart

GEOLOGICAL SURVEY
 OF
 THE OMKOI AREA, KINGDOM OF THAILAND
 PHASE III
 GEOLOGICAL PROFILE OF DRILLING
 (AREA A)

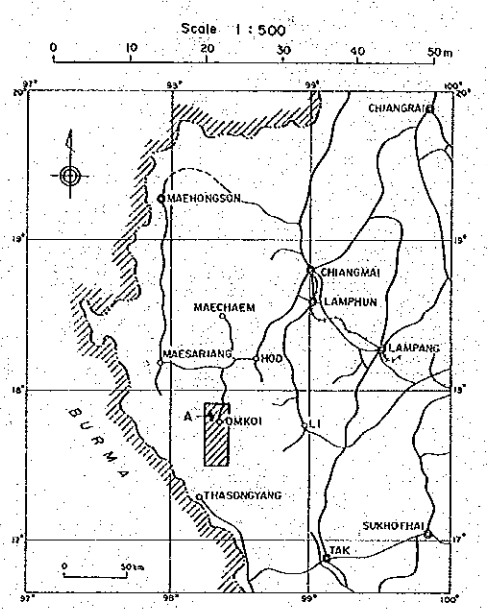

JAPAN INTERNATIONAL COOPERATION AGENCY
 METAL MINING AGENCY OF JAPAN
 May 1986

Area A2

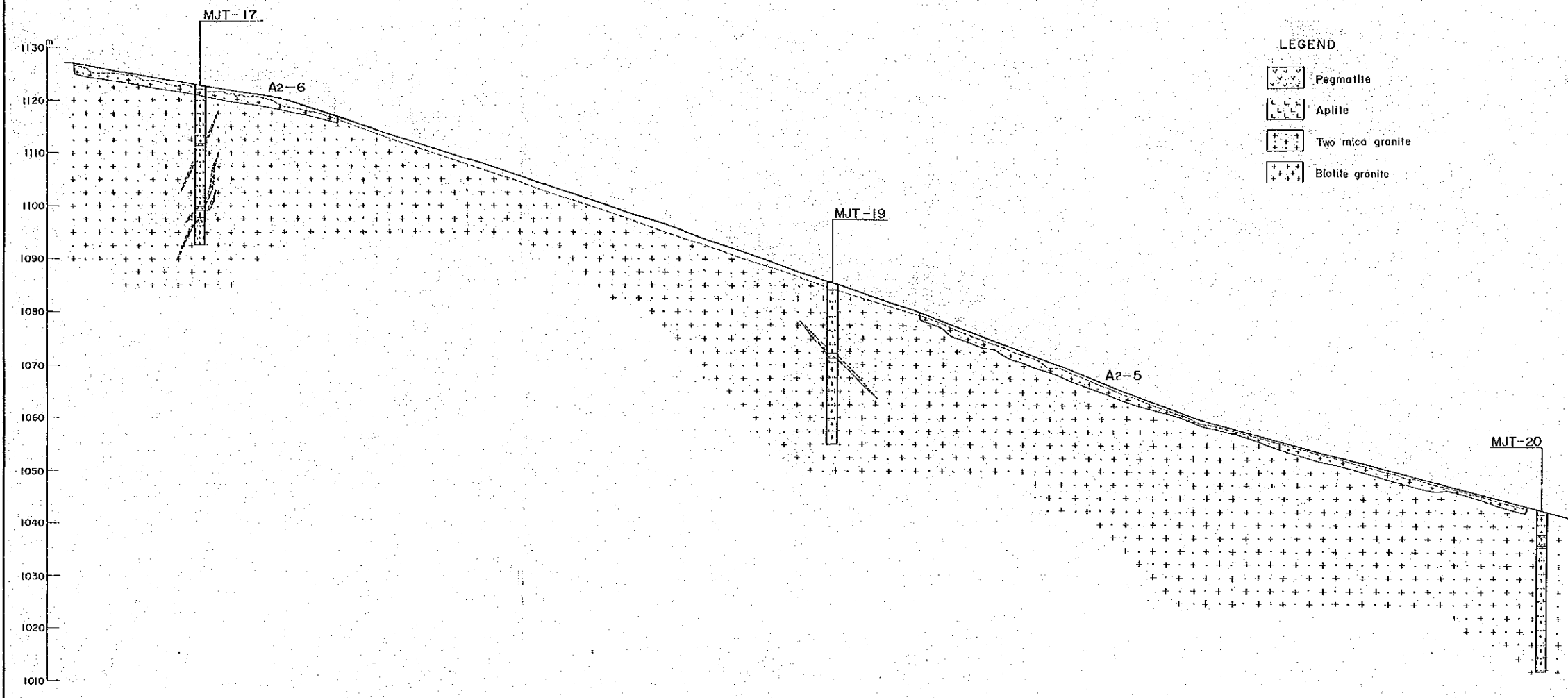

- LEGEND
- Pegmatite
 - Aplite
 - Two mica granite
 - Biotite granite

Area A1

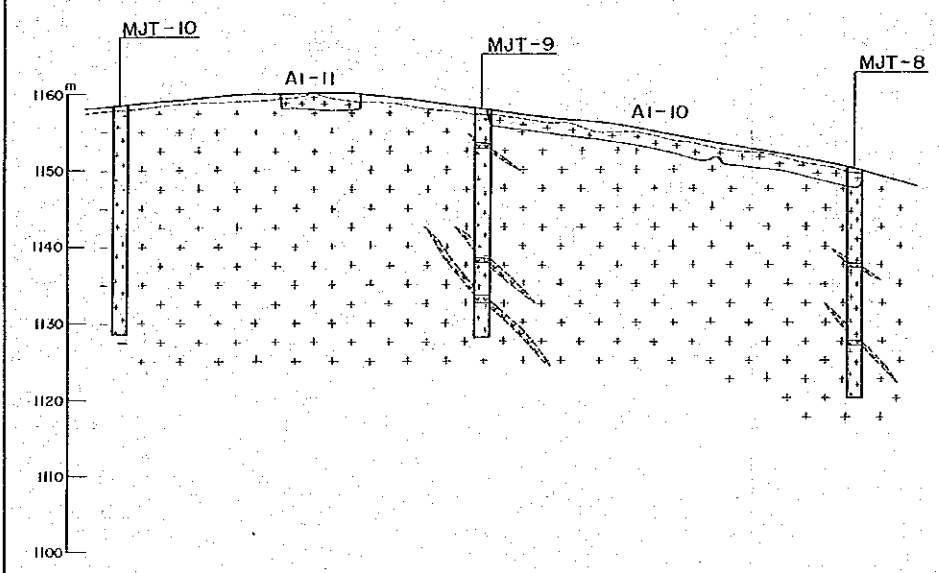



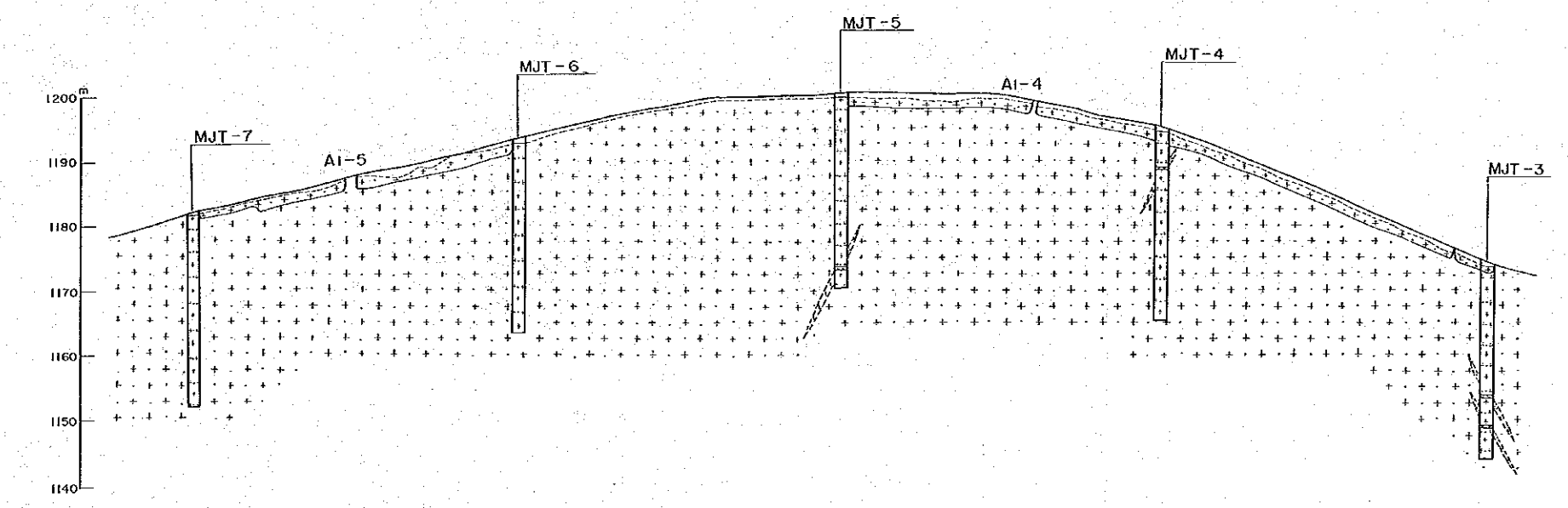

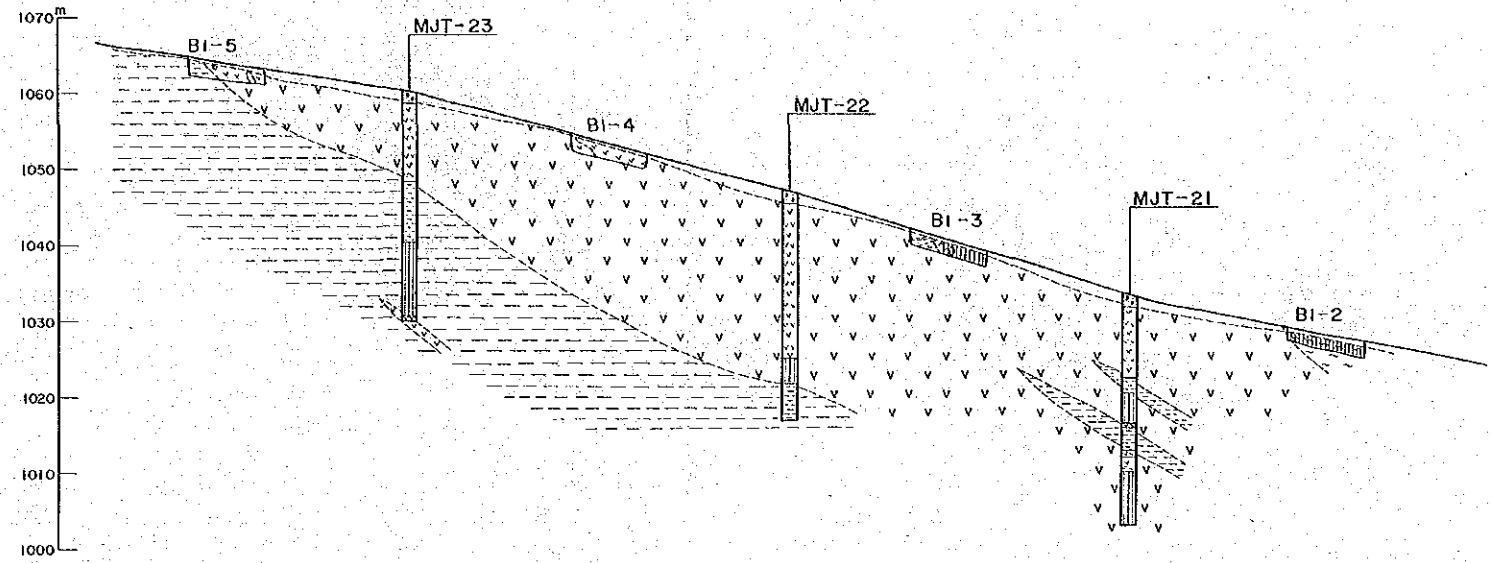

Area A1



Area B1



LEGEND

-  Calc-silicate rock
-  Quartz vein
-  Pegmatite
-  Quartz schist
-  Biolite granite
-  Biolite paragneiss
-  Altered rock

PL-2
 国际协力機関
 15734
 国書資料院蔵
 GEOLOGICAL SURVEY
 OF
 THE OMKOI AREA, KINGDOM OF THAILAND
 PHASE III
 GEOLOGICAL PROFILE OF DRILLING
 (AREA B)

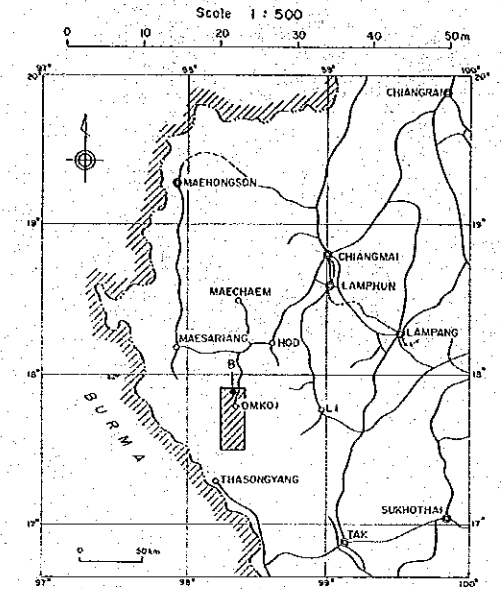

JAPAN INTERNATIONAL COOPERATION AGENCY
 METAL MINING AGENCY OF JAPAN

May 1986

Area B2

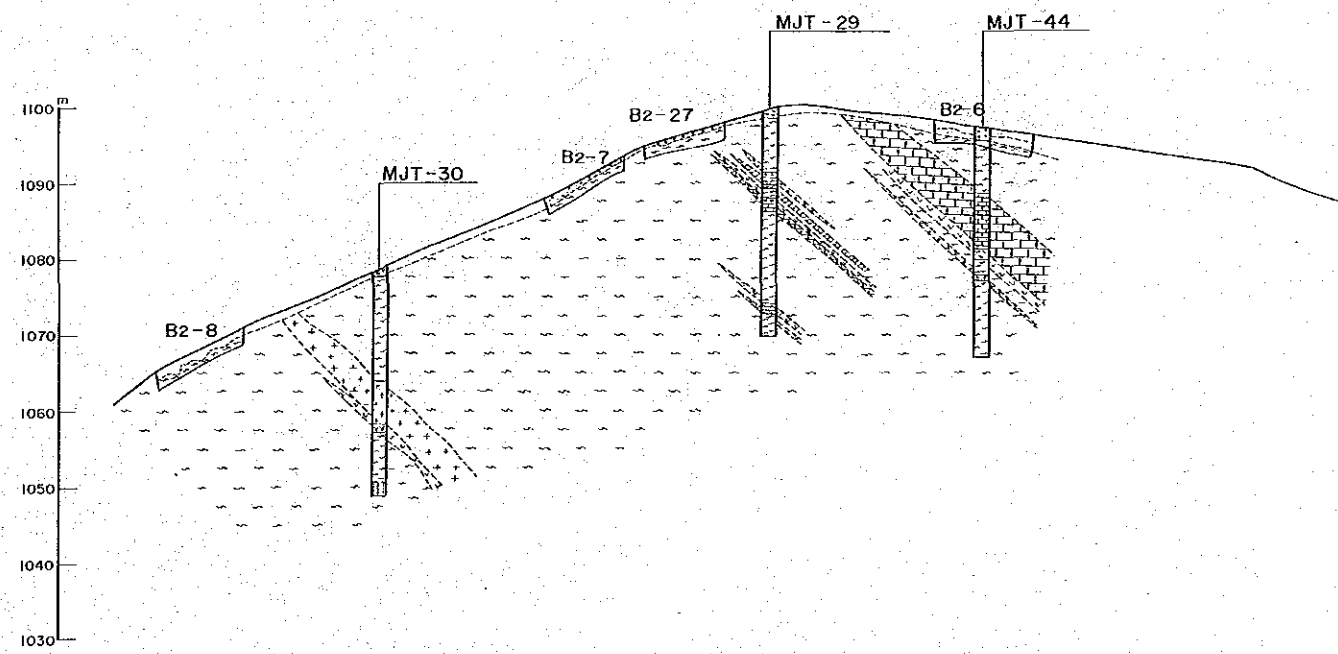

Area B2

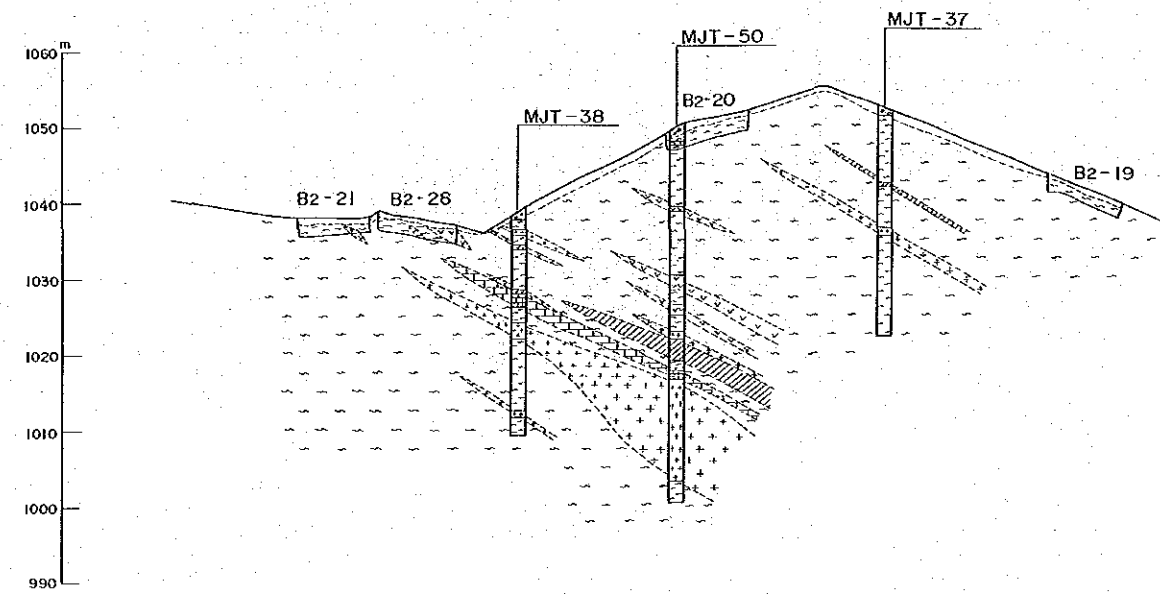

A1-1

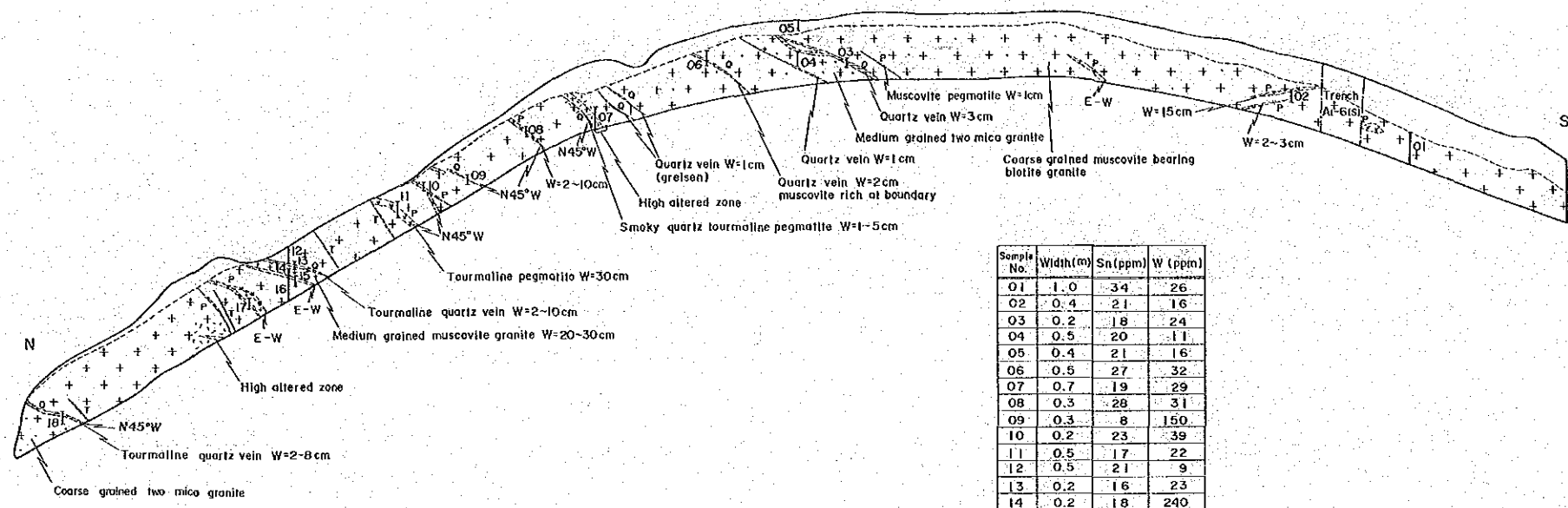

Sample No.	Width(m)	Sn(ppm)	W(ppm)
01	1.0	34	26
02	0.4	21	16
03	0.2	18	24
04	0.5	20	11
05	0.4	21	16
06	0.5	27	32
07	0.7	19	29
08	0.3	28	31
09	0.3	8	150
10	0.2	23	39
11	0.5	17	22
12	0.5	21	9
13	0.2	16	23
14	0.2	18	240
15	0.4	25	340
16	0.8	22	19
17	0.3	20	22
18	0.4	15	280

A1-2

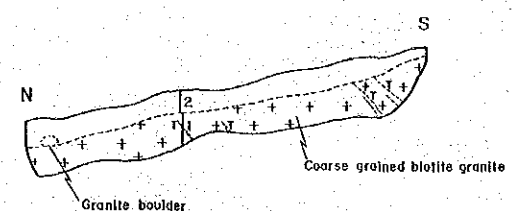

Sample No.	Width(m)	Sn(ppm)	W(ppm)
1	0.9	36	46
2	0.6	35	46

A1-3

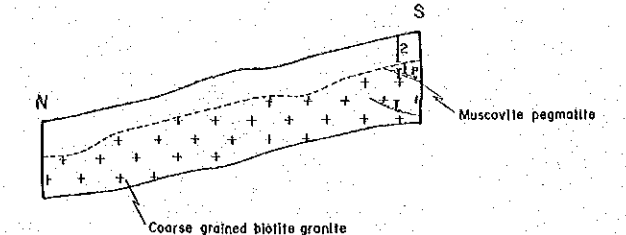

Sample No.	Width(m)	Sn(ppm)	W(ppm)
1	0.2	33	46
2	0.7	41	67

A1-4

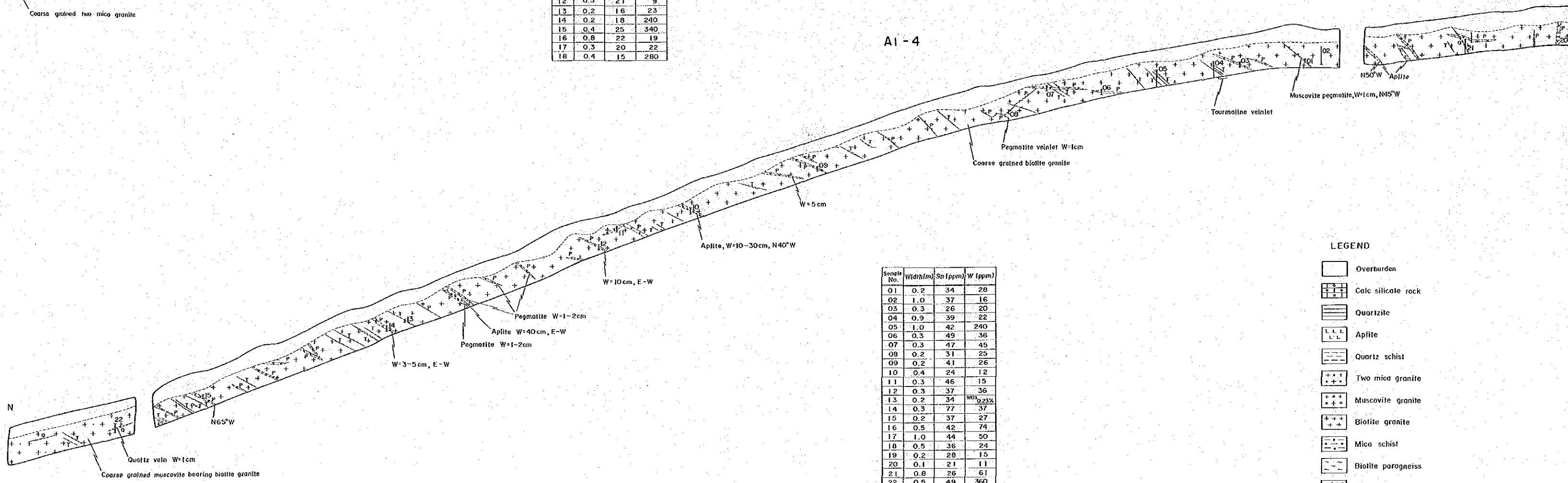

Sample No.	Width(m)	Sn(ppm)	W(ppm)
01	0.2	34	28
02	1.0	37	16
03	0.3	26	20
04	0.9	39	22
05	1.0	42	240
06	0.3	49	36
07	0.3	47	45
08	0.2	31	25
09	0.2	41	26
10	0.4	24	12
11	0.3	46	15
12	0.3	37	36
13	0.2	34	23%
14	0.3	77	37
15	0.2	37	27
16	0.5	42	74
17	1.0	44	50
18	0.5	36	24
19	0.2	28	15
20	0.1	21	11
21	0.8	26	61
22	0.5	49	360
23	0.8	45	270

LEGEND

- Overburden
- Calc silicate rock
- Quartzite
- Aplite
- Quartz schist
- Two mica granite
- Muscovite granite
- Biotite granite
- Mica schist
- Biotite paragneiss
- Altered rock
- Pegmatite vein
- Quartz vein
- Tourmaline vein
- Sampling channel and sample number

A1-1

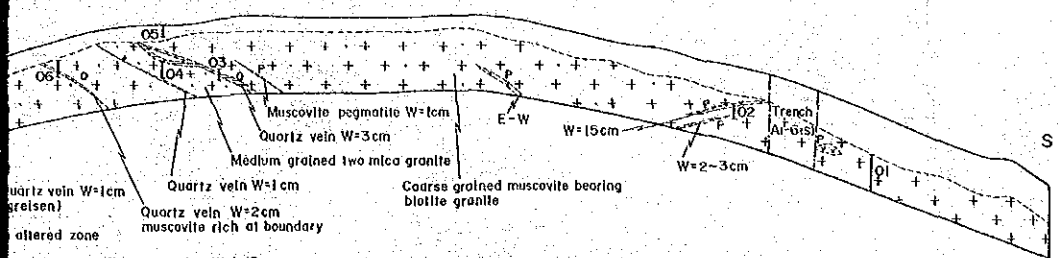

Sample No.	Width(m)	Sn(ppm)	W(ppm)
01	1.0	34	26
02	0.4	21	16
03	0.2	18	24
04	0.5	20	11
05	0.4	21	16
06	0.5	27	32
07	0.7	19	29
08	0.3	28	31
09	0.3	8	150
10	0.2	23	39
11	0.5	17	22
12	0.5	21	9
13	0.2	16	23
14	0.2	18	240
15	0.4	25	340
16	0.8	22	19
17	0.3	20	22
18	0.4	15	280

A1-2

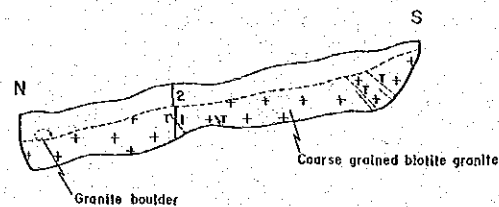

Sample No.	Width(m)	Sn(ppm)	W(ppm)
1	0.9	36	428
2	0.6	35	46

A1-3

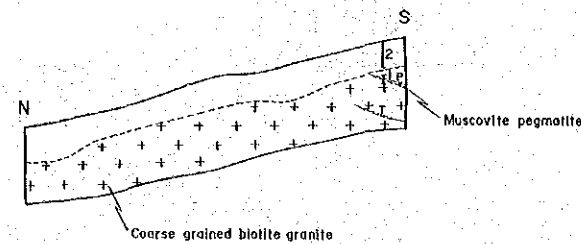

Sample No.	Width(m)	Sn(ppm)	W(ppm)
1	0.2	33	46
2	0.7	41	67

A1-4

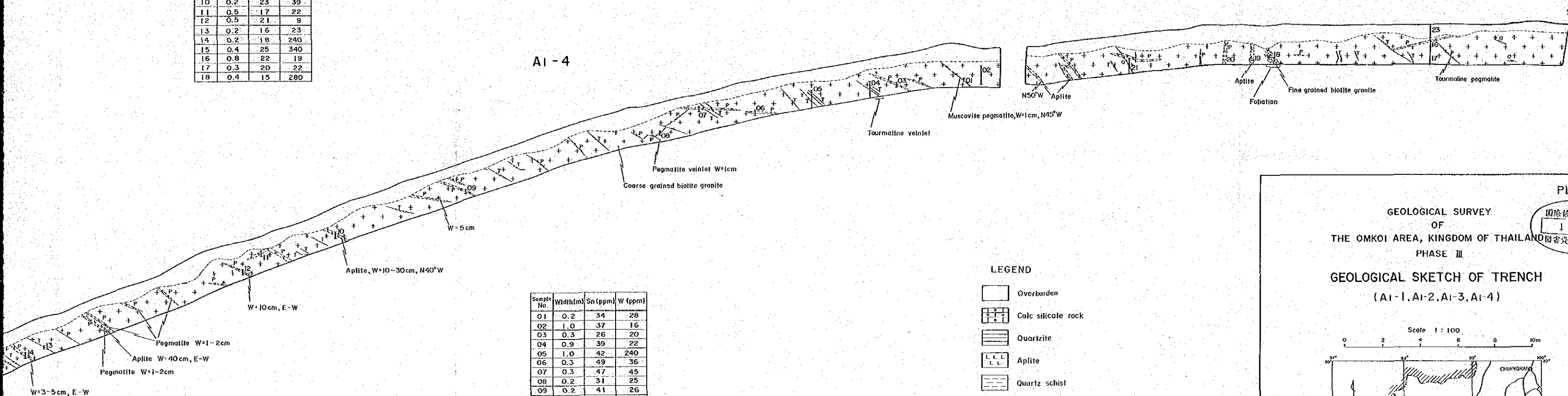

Sample No.	Width(m)	Sn(ppm)	W(ppm)
01	0.2	34	28
02	1.0	37	16
03	0.3	26	20
04	0.9	39	22
05	1.0	42	240
06	0.3	49	36
07	0.3	47	45
08	0.2	31	25
09	0.2	41	26
10	0.4	24	12
11	0.3	46	15
12	0.3	37	36
13	0.2	34	37
14	0.3	77	37
15	0.2	37	27
16	0.5	42	74
17	1.0	44	50
18	0.5	36	24
19	0.2	28	15
20	0.1	21	11
21	0.8	26	61
22	0.5	49	360
23	0.6	45	270

LEGEND

- Overburden
- Calc silicate rock
- Quartzite
- Aplite
- Quartz schist
- Two mica granite
- Muscovite granite
- Biotite granite
- Mica schist
- Biotite paragneiss
- Altered rock
- Pegmatite vein
- Quartz vein
- Tourmaline vein

[5] Sampling channel and sample number

GEOLOGICAL SURVEY OF THE OMKOI AREA, KINGDOM OF THAILAND PHASE III
GEOLOGICAL SKETCH OF TRENCH (A1-1, A1-2, A1-3, A1-4)

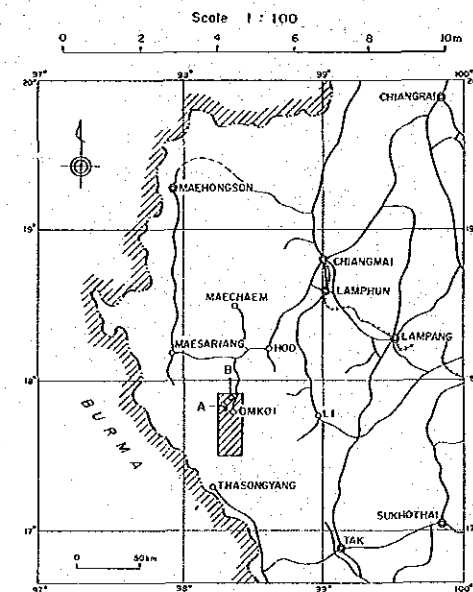

JAPAN INTERNATIONAL COOPERATION AGENCY METAL MINING AGENCY OF JAPAN

May 1986

PL. 3

国際協力事業団 15734 図書資料室蔵

A1-5

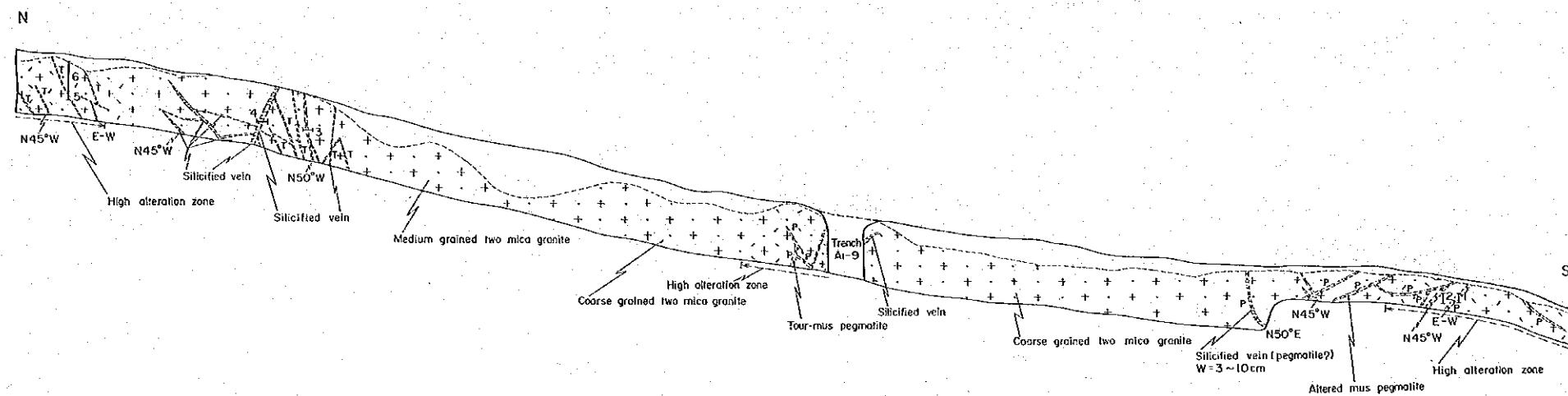

Sample No.	Width (m)	Sn (ppm)	W (ppm)
1	0.3	30	49
2	0.3	33	29
3	0.2	82	100
4	0.3	52	29
5	0.3	53	27
6	0.9	58	23

A1-6(N)

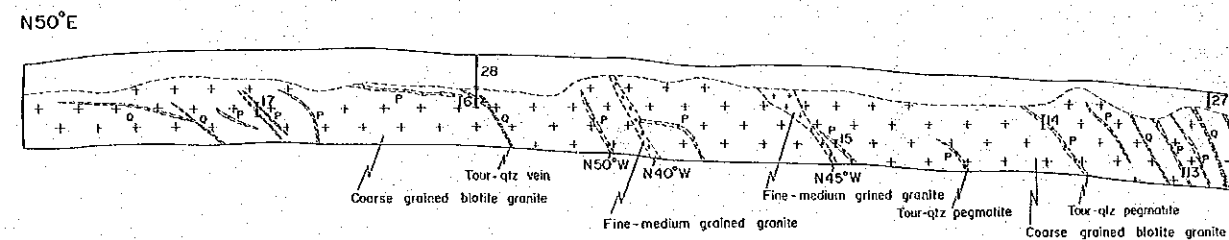

Sample No.	Width (m)	Sn (ppm)	W (ppm)
10	0.2	35	280
11	0.2	19	29
12	0.2	26	20
13	0.2	13	18
14	0.4	44	100.53%
15	0.2	19	46
16	0.6	23	100.29%
17	0.4	17	100.29%
27	0.4	39	91
28	0.6	47	210

A1-6 (M)

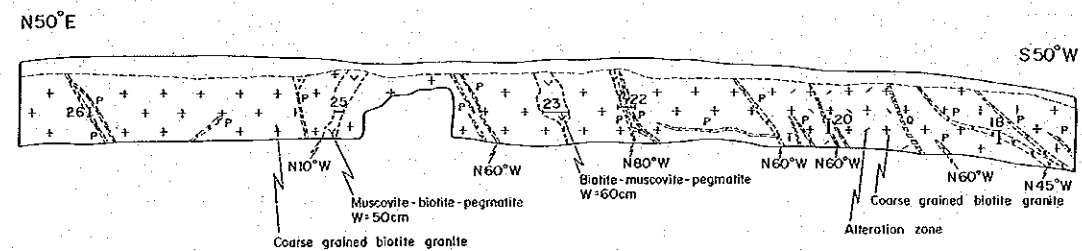

Sample No.	Width (m)	Sn (ppm)	W (ppm)
18	0.4	21	9
20	0.4	38	130
22	0.5	28	100.81%
23	0.7	31	70
25	0.5	27	43
26	0.3	28	46

A1-6 (S)

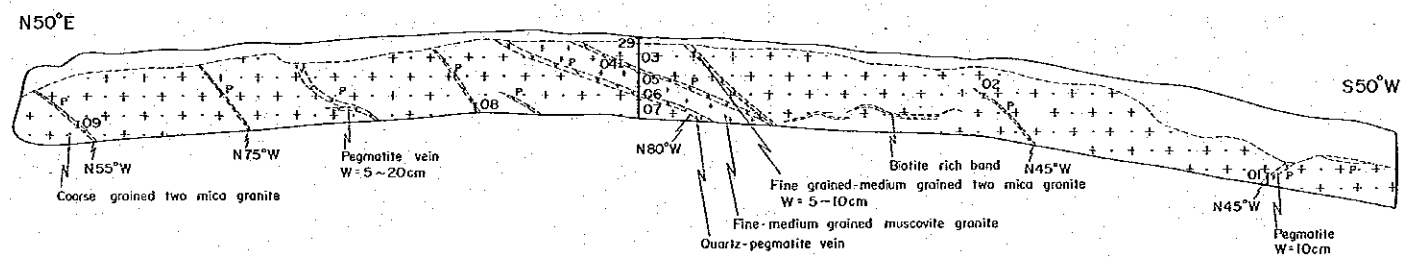

Sample No.	Width (m)	Sn (ppm)	W (ppm)
01	0.3	23	10
02	0.1	63	35
03	0.5	23	12
04	0.1	16	10
05	0.5	19	10
06	0.2	21	2
07	0.5	20	7
08	0.3	33	16
09	0.2	33	49
29	0.5	33	15

GEOLOGICAL
THE OMKORI AREA
GEOLOGICAL
(A1-5, A1-6(N))

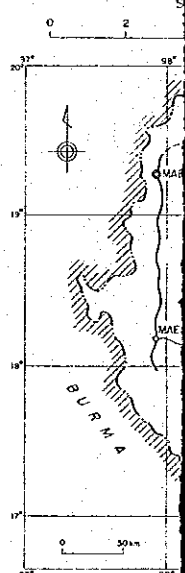

JAPAN INTERNATIONAL
METAL MINING

LEGEND is the same as that of PL.3

A1-5

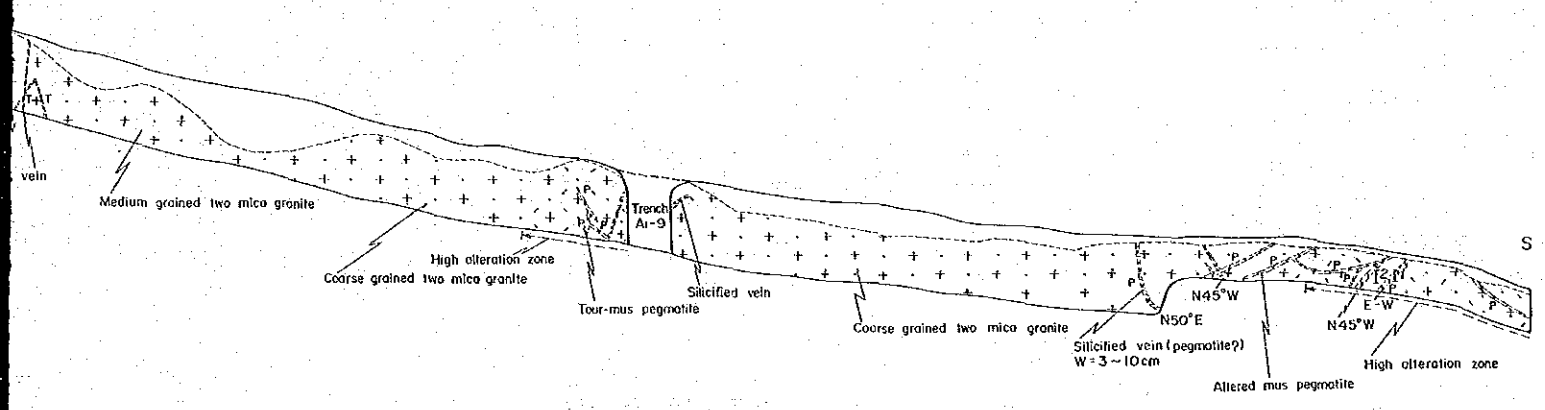

Sample No.	Width (m)	Sn (ppm)	W (ppm)
1	0.3	30	49
2	0.3	33	29
3	0.2	82	100
4	0.3	52	29
5	0.3	53	27
6	0.9	58	23

A1-6(N)

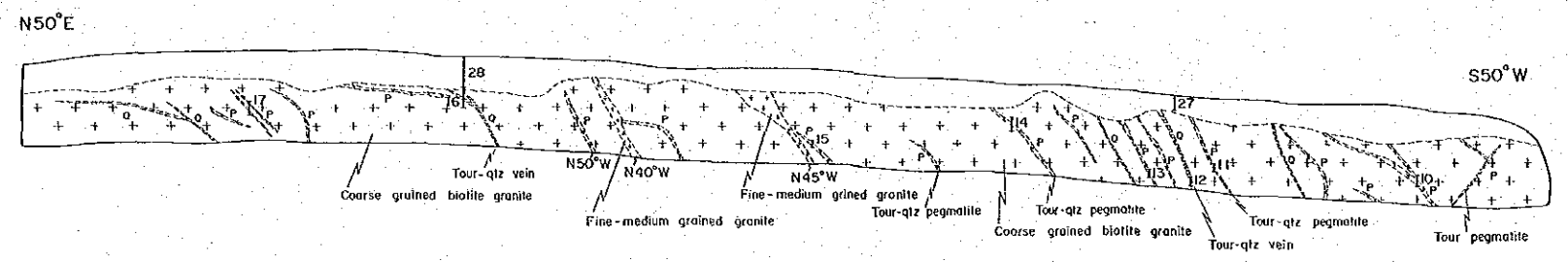

Sample No.	Width (m)	Sn (ppm)	W (ppm)
10	0.2	35	280
11	0.2	19	29
12	0.2	26	20
13	0.2	13	18
14	0.4	44	W0.33%
15	0.2	19	46
16	0.6	23	W0.29%
17	0.4	17	W0.29%
27	0.4	39	91
28	0.6	47	210

A1-6 (M)

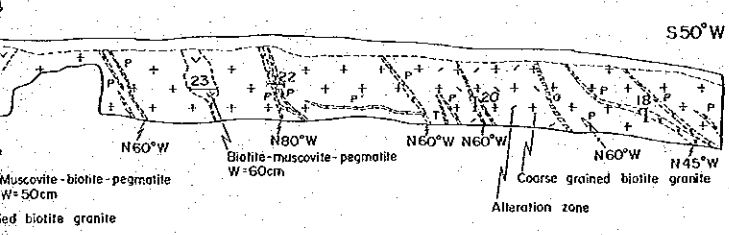

Sample No.	Width (m)	Sn (ppm)	W (ppm)
18	0.4	21	9
20	0.4	38	130
22	0.5	28	W0.81%
23	0.7	31	70
25	0.5	27	43
26	0.3	28	46

A1-6 (S)

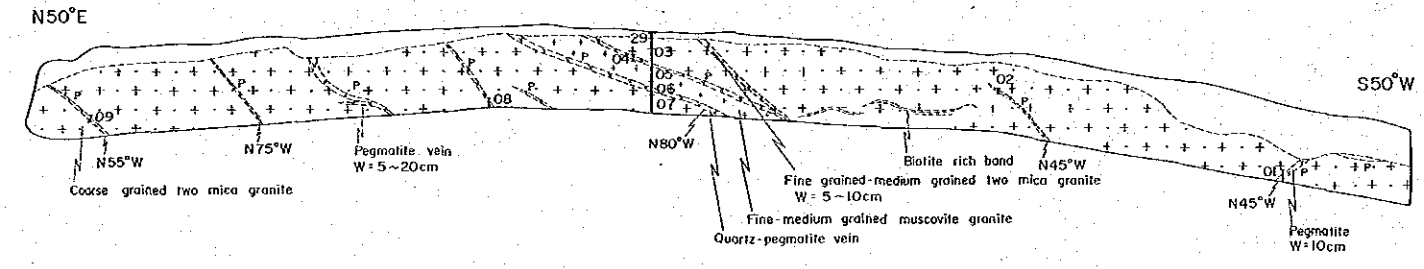

Sample No.	Width (m)	Sn (ppm)	W (ppm)
01	0.3	23	10
02	0.1	63	35
03	0.5	23	12
04	0.1	16	10
05	0.5	19	10
06	0.2	21	2
07	0.5	20	7
08	0.3	33	16
09	0.2	33	49
29	0.5	33	15

PL. 4
 GEOLOGICAL SURVEY OF THE OMKOI AREA, KINGDOM OF THAILAND
 PHASE III

GEOLOGICAL SKETCH OF TRENCH (A1-5, A1-6(N), A1-6(M), A1-6(S))

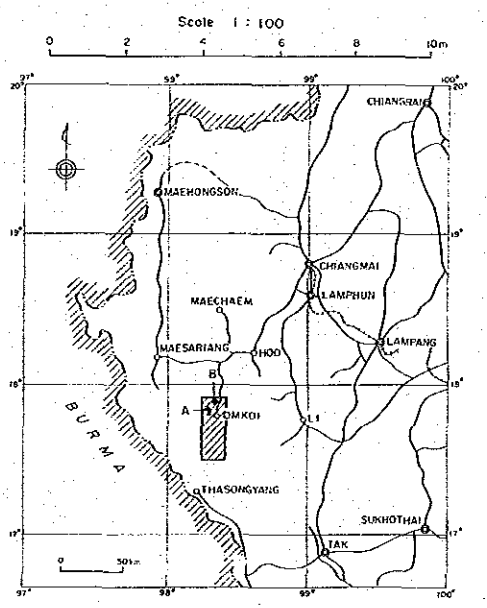

JAPAN INTERNATIONAL COOPERATION AGENCY METAL MINING AGENCY OF JAPAN

May 1986

LEGEND is the same as that of PL.3

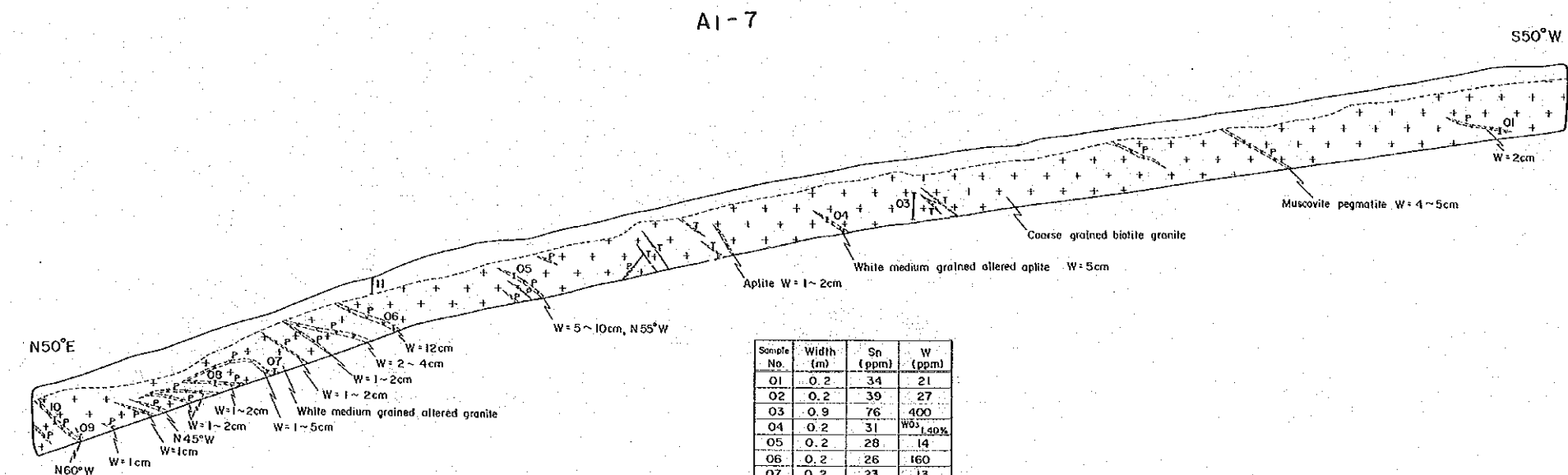

Sample No.	Width (m)	Sn (ppm)	W (ppm)
O1	0.2	34	21
O2	0.2	39	27
O3	0.9	76	400
O4	0.2	31	W ⁰¹ 140%
O5	0.2	28	14
O6	0.2	26	160
O7	0.2	23	13
O8	0.2	22	24
O9	0.2	25	24
O10	0.2	17	14
O11	0.5	32	44

W=12cm
W=2-4cm
W=1-2cm
W=1-2cm
W=1-2cm
W=1-5cm
White medium grained altered granite
N45°W
W=1cm
W=1cm
N60°W

A1-8

Sample No.	Width (m)	Sn (ppm)	W (ppm)
1	0.2	42	810
3	0.2	36	34
4	0.2	28	7
5	0.1	23	13
6	0.2	40	25
7	0.2	38	47
8	0.2	38	18
10	0.6	34	11
12	0.2	28	41
13	0.2	19	11

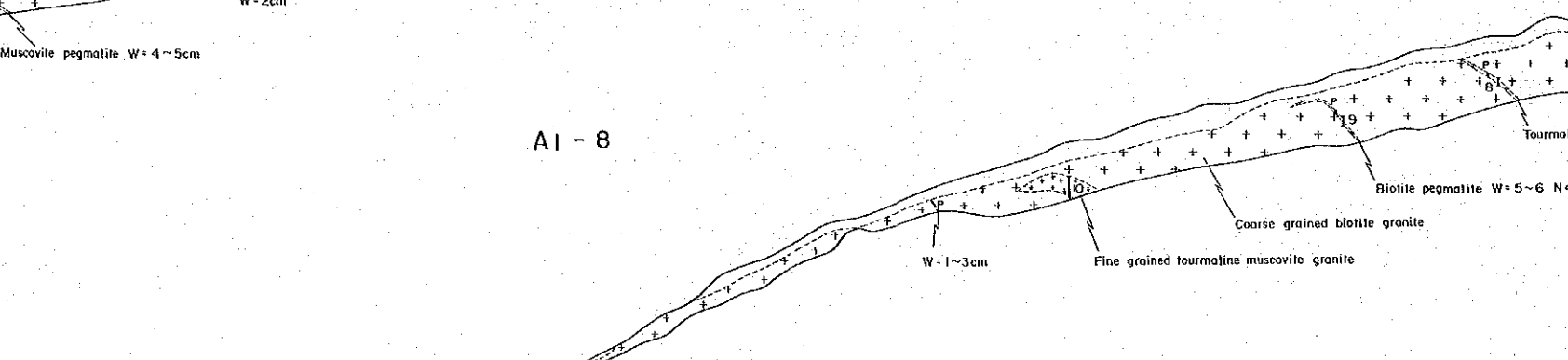

Sample No.	Width (m)	Sn (ppm)	W (ppm)
1	0.4	38	38
2	0.3	29	48
3	0.2	50	130
4	0.2	100	100
5	0.4	31	3900
6	0.4	25	17
7	0.3	38	31
8	0.5	38	21
9	0.2	37	16
10	0.4	19	10
11	0.3	37	1600
12	0.5	49	44
13	0.5	39	46
14	0.5	53	56
15	0.5	56	36
16	0.5	63	46
17	0.5	42	53
18	0.5	41	54
19	0.6	45	32
20	0.5	43	63
21	0.5	39	79
22	0.6	41	62
23	0.5	33	52
24	0.5	34	46
25	0.5	33	36
26	0.4	37	36
27	0.5	32	34
28	0.5	33	26
29	0.5	42	20
30	0.4	40	24
31	0.6	30	27
32	0.5	47	38

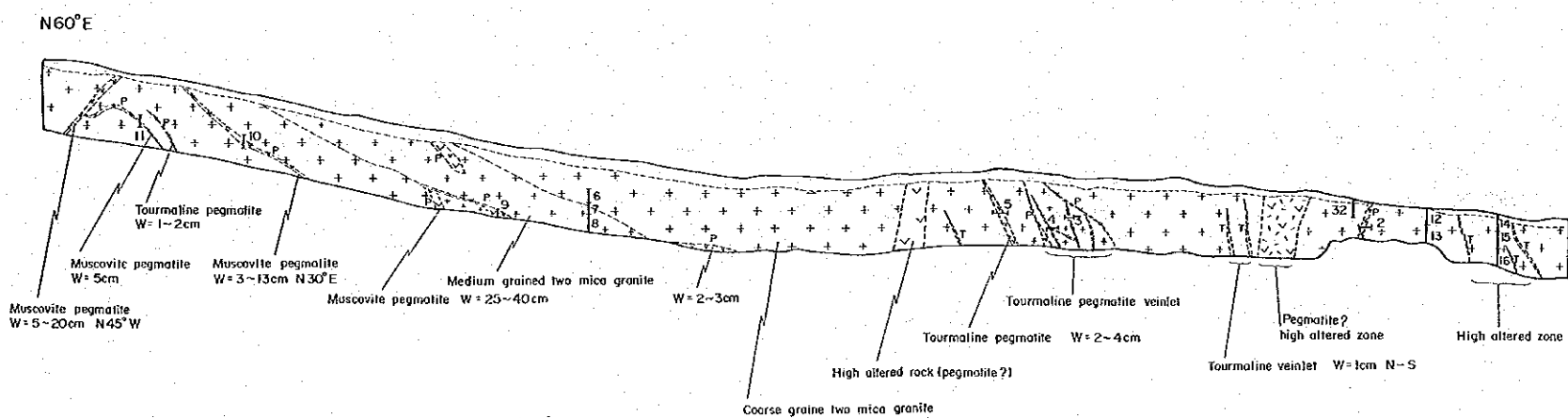

A1-9

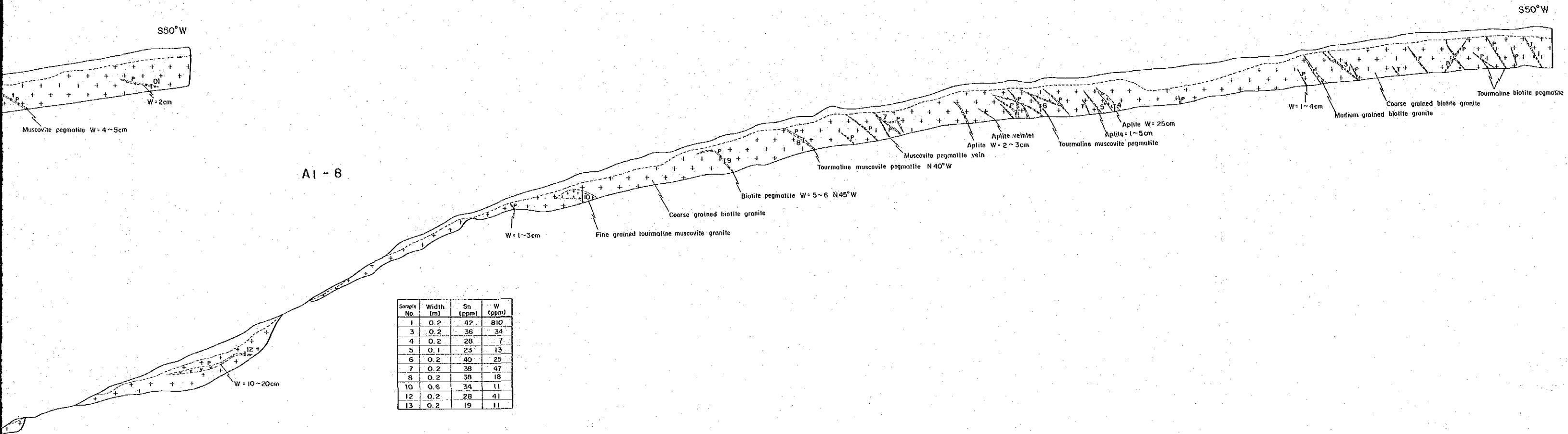

A1-9

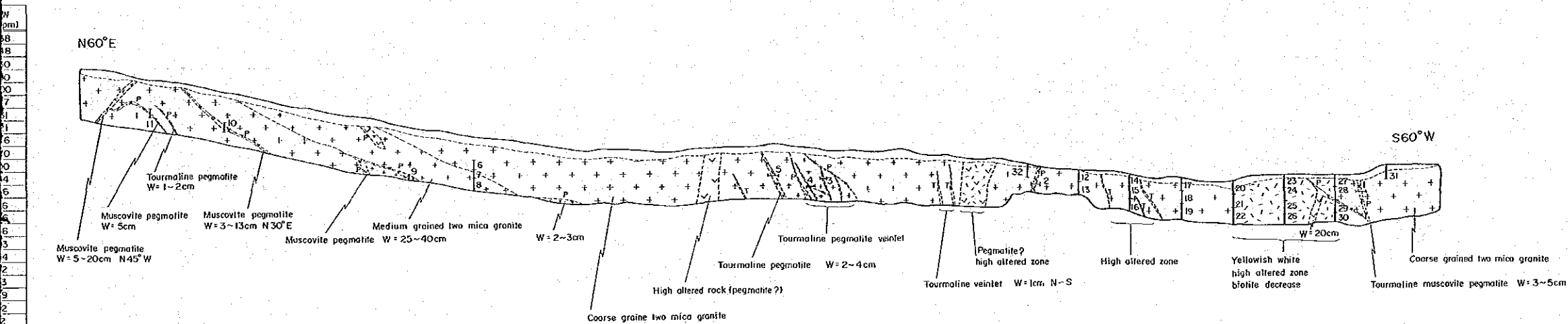

LEGEND is the same as that of PL.3

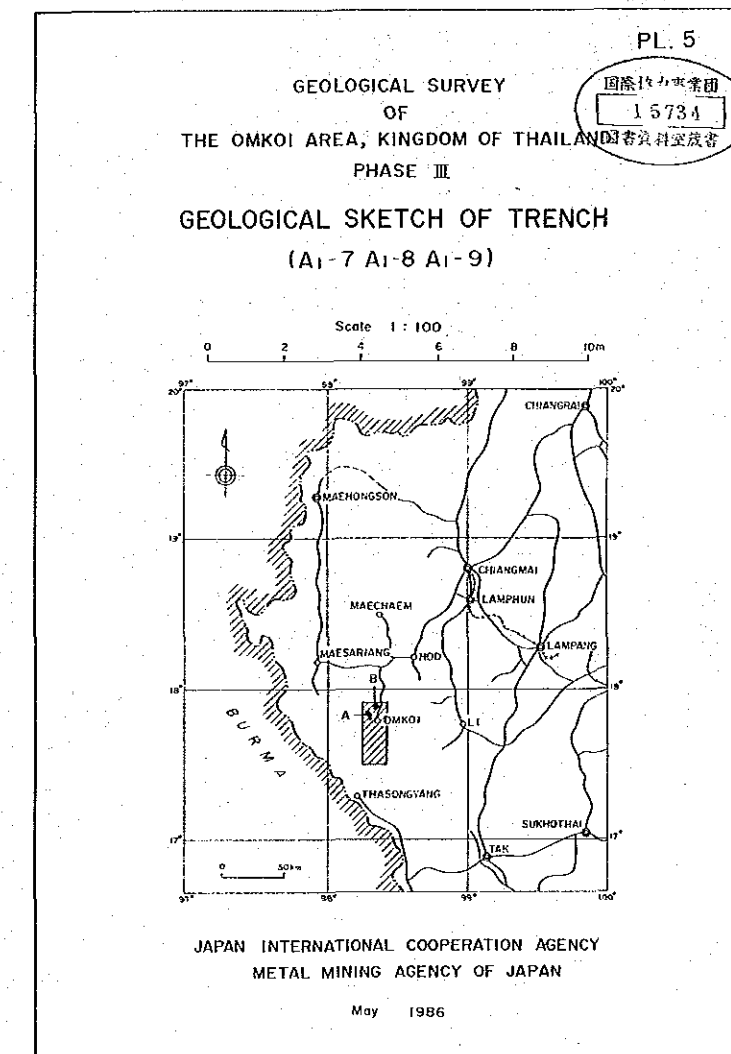

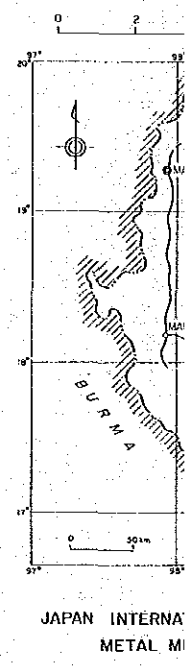

AI-10

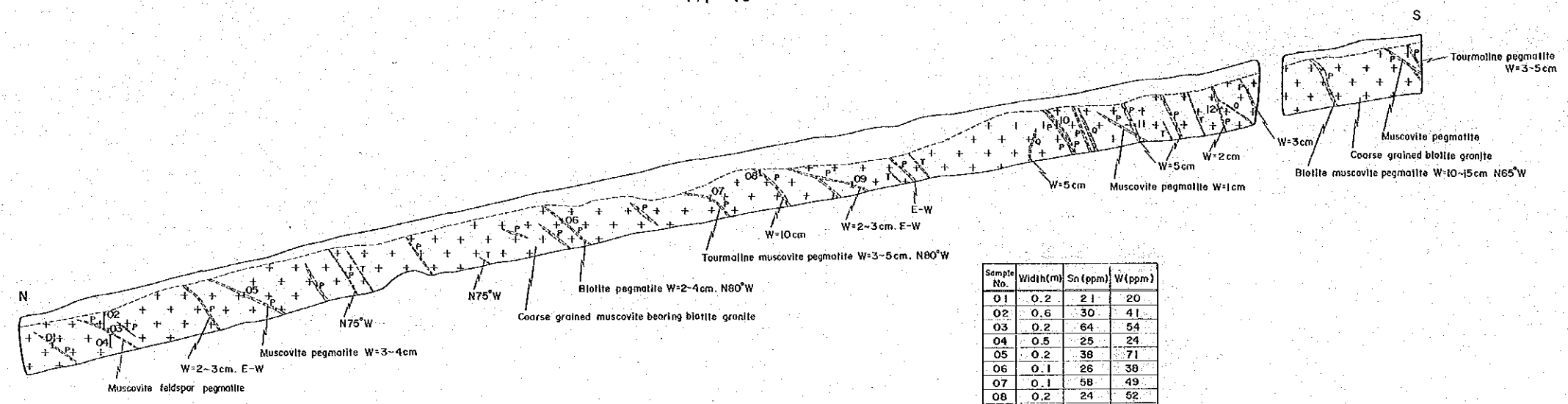

Sample No.	Width(m)	Sn(ppm)	W(ppm)
01	0.2	21	20
02	0.6	30	41
03	0.2	64	54
04	0.5	25	24
05	0.2	38	71
06	0.1	26	38
07	0.1	58	49
08	0.2	24	52
09	0.2	41	57
10	0.2	30	51
11	0.2	31	67
12	0.2	34	37

AI-11

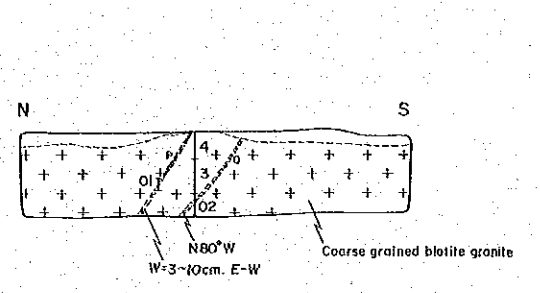

Sample No.	Width(m)	Sn(ppm)	W(ppm)
01	0.3	18	18
02	0.6	16	15
3	1.0	25	31
4	0.7	28	55

AI-12

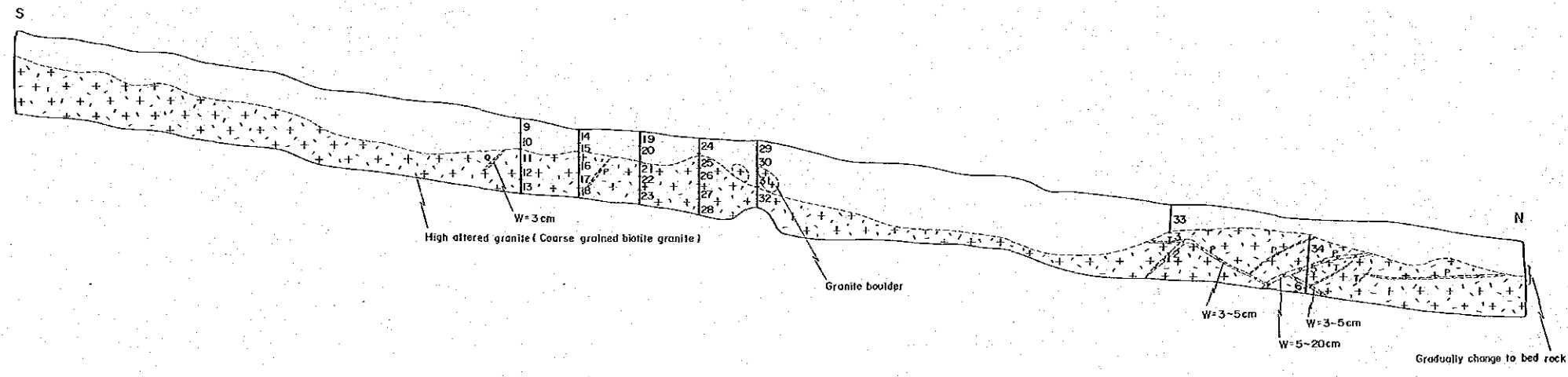

Sample No.	Width(m)	Sn(ppm)	W(ppm)
2	0.1	21	10
3	0.1	40	2
5	0.5	31	29
6	0.6	31	32
9	0.5	21	40
10	0.5	25	30
11	0.5	25	38
12	0.5	12	8
13	0.4	22	45
14	0.5	23	31
15	0.5	26	31
16	0.5	23	70
17	0.5	21	23
18	0.5	21	19
19	0.5	17	34
20	0.5	27	41
21	0.5	25	46
22	0.5	23	59
23	0.5	22	33
24	0.5	20	32
25	0.5	29	35
26	0.5	22	35
27	0.5	23	30
28	0.5	21	44
29	0.5	25	35
30	0.5	29	48
31	0.5	29	57
32	0.7	24	47
33	0.9	27	49
34	0.8	31	870

AI-13

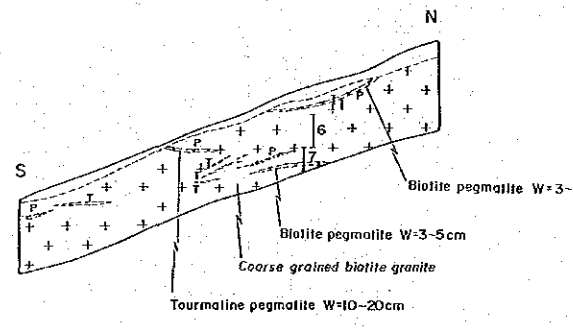

Sample No.	Width(m)	Sn(ppm)	W(ppm)
1	0.2	33	22
6	0.8	33	21
7	0.6	33	18

GEOLOGICAL SKETCH OF TRENCH
(A1-10, A1-11, A1-12, A1-13)

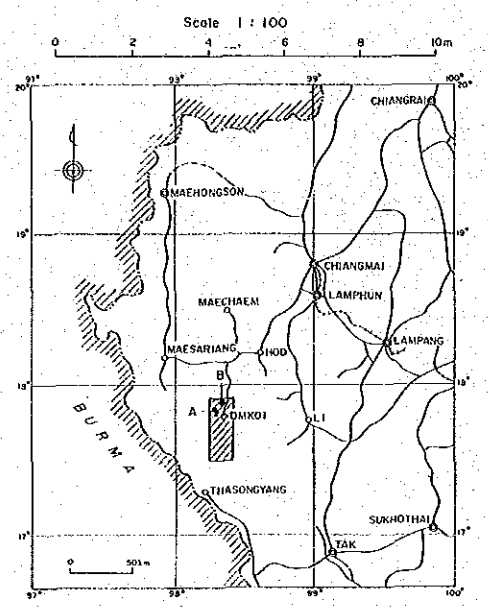

JAPAN INTERNATIONAL COOPERATION AGENCY
METAL MINING AGENCY OF JAPAN
May 1986

A1-10

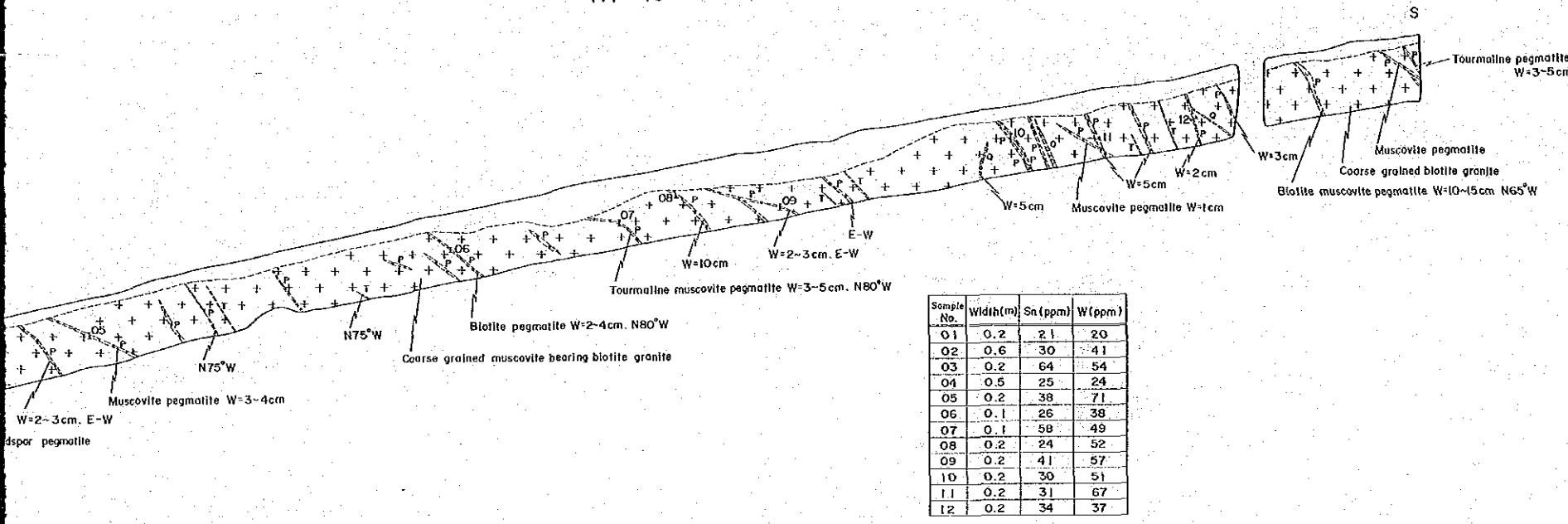

Sample No.	Width(m)	Sn(ppm)	W(ppm)
01	0.2	21	29
02	0.6	30	41
03	0.2	64	54
04	0.5	25	24
05	0.2	38	71
06	0.1	26	38
07	0.1	58	49
08	0.2	24	52
09	0.2	41	57
10	0.2	30	51
11	0.2	31	67
12	0.2	34	37

A1-11

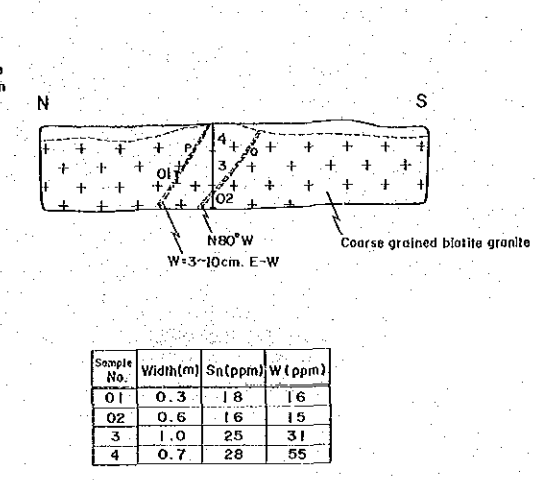

Sample No.	Width(m)	Sn(ppm)	W(ppm)
01	0.3	18	16
02	0.6	16	15
3	1.0	25	31
4	0.7	28	55

A1-12

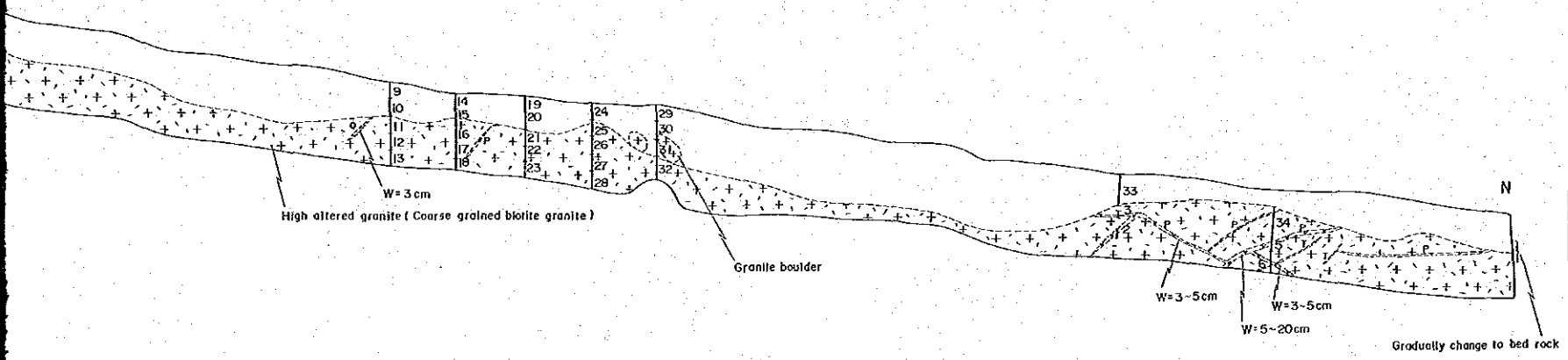

Sample No.	Width(m)	Sn(ppm)	W(ppm)
2	0.1	21	10
3	0.1	40	2
5	0.5	31	29
6	0.6	31	32
9	0.5	21	40
10	0.5	25	30
11	0.5	25	38
12	0.5	12	8
13	0.4	22	45
14	0.5	23	31
15	0.5	26	31
16	0.5	23	70
17	0.5	21	23
18	0.5	21	19
19	0.5	17	34
20	0.5	27	41
21	0.5	25	46
22	0.5	23	59
23	0.5	22	33
24	0.5	20	32
25	0.5	29	35
26	0.5	22	35
27	0.5	23	30
28	0.5	21	44
29	0.5	25	35
30	0.5	29	48
31	0.5	29	57
32	0.7	24	47
33	0.9	27	49
34	0.8	31	870

A1-13

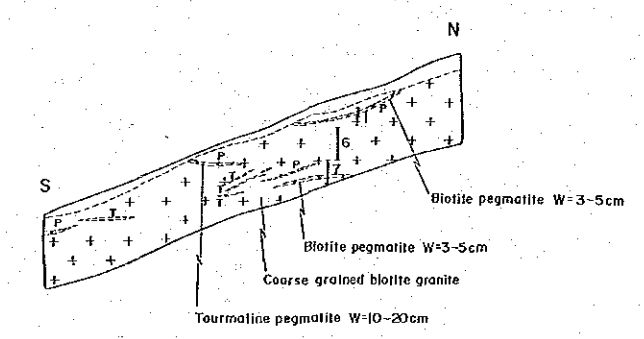

Sample No.	Width(m)	Sn(ppm)	W(ppm)
1	0.2	33	22
6	0.8	33	21
7	0.6	33	18

LEGEND is the same as that of PL.3

PHASE III
 GEOLOGICAL SKETCH OF TRENCH
 (A2-1, A2-2, A2-3)

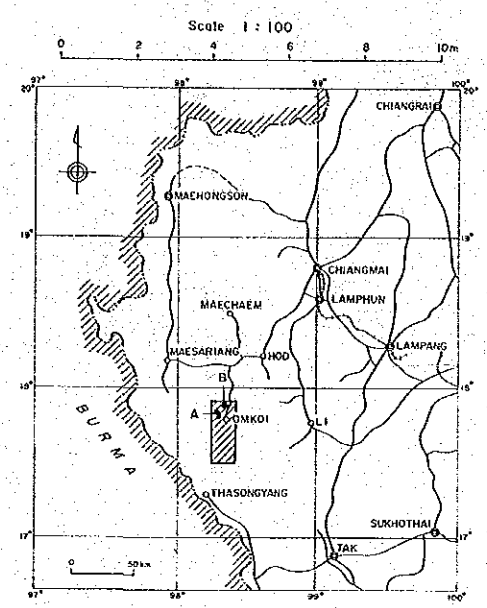

JAPAN INTERNATIONAL COOPERATION AGENCY
 METAL MINING AGENCY OF JAPAN
 May 1986

A2-1

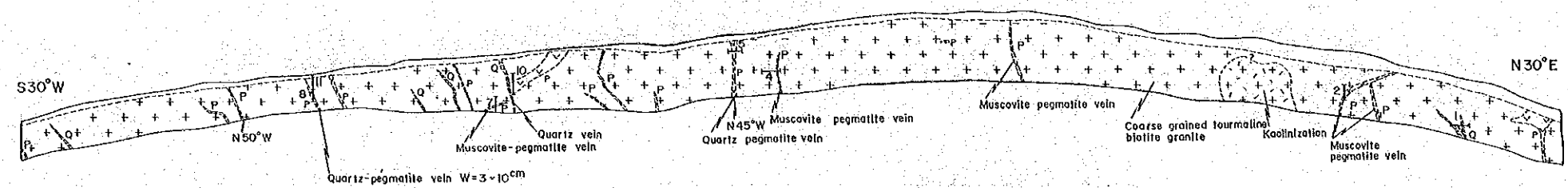

Sample No.	Width (m)	Sn (ppm)	W (ppm)
1	0.6	27	4
2	0.5	20	4
4	0.6	31	30
5	0.5	23	11
7	0.5	85	6
8	0.4	32	5
10	0.7	70	5
11	0.5	59	4

A2-2

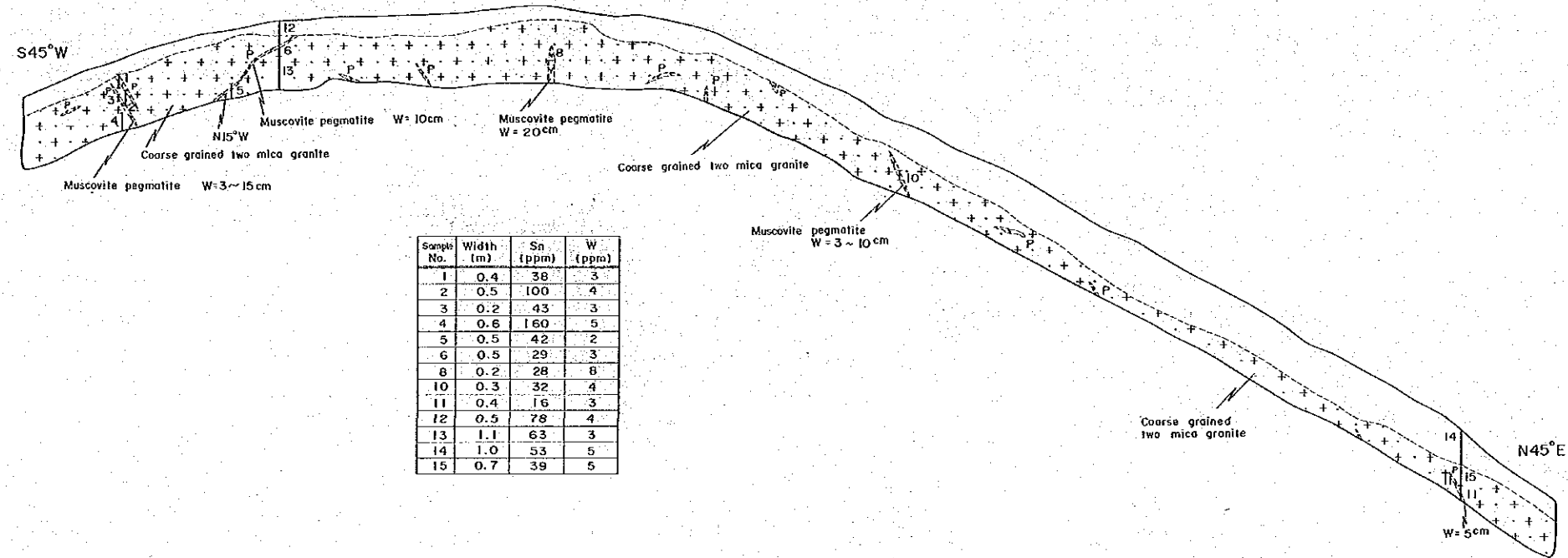

Sample No.	Width (m)	Sn (ppm)	W (ppm)
1	0.4	38	3
2	0.5	100	4
3	0.2	43	3
4	0.6	160	5
5	0.5	42	2
6	0.5	29	3
8	0.2	28	8
10	0.3	32	4
11	0.4	16	3
12	0.5	78	4
13	1.1	63	3
14	1.0	53	5
15	0.7	39	5

A2-3

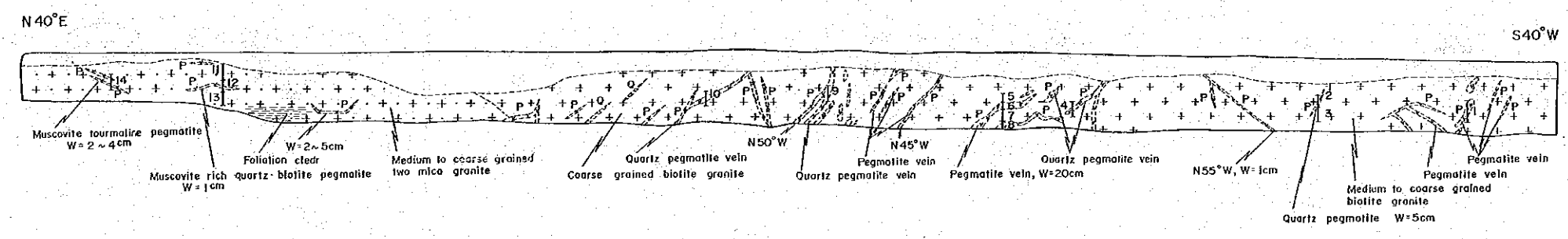

Sample No.	Width (m)	Sn (ppm)	W (ppm)
1	0.7	19	4
2	0.4	27	4
3	0.5	38	3
4	0.5	52	5
5	0.3	60	3
6	0.4	22	6
7	0.4	69	3
8	0.2	41	5
9	0.5	41	6
10	0.5	59	4
11	0.6	120	3
12	0.4	120	7
13	0.6	130	6
14	0.5	160	14

LEGEND is the same as that of PL.3

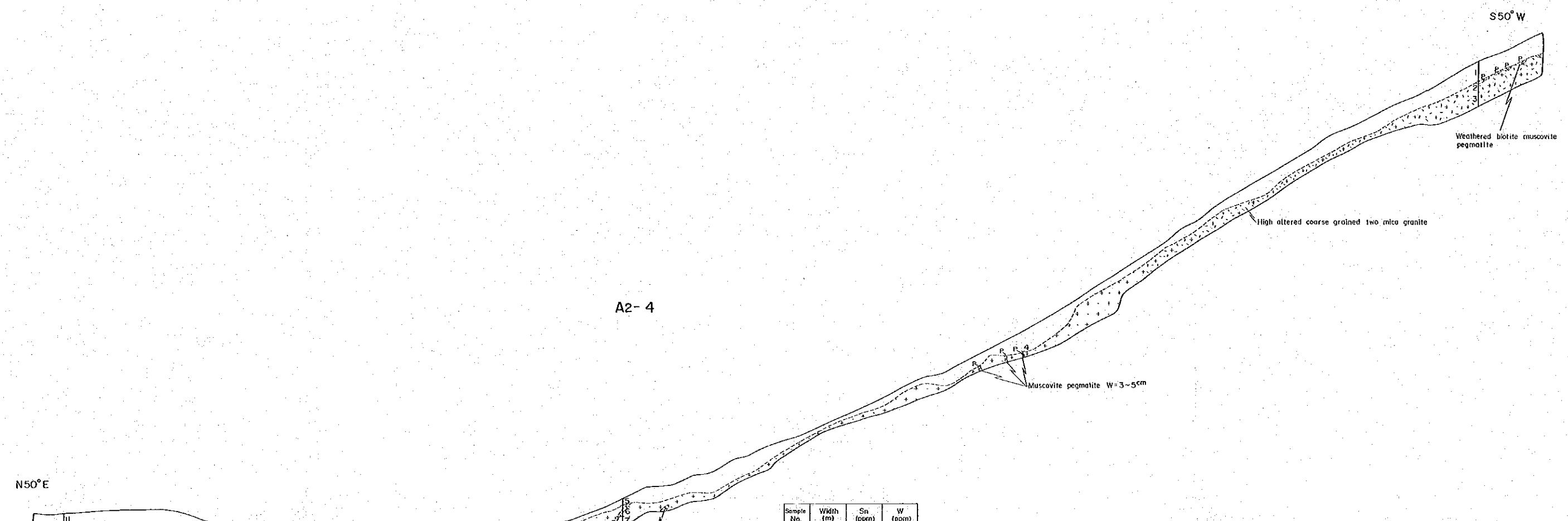

A2-4

Sample No.	Width (m)	Sn (ppm)	W (ppm)
1	1.0	89	8
2	0.5	55	5
3	0.7	120	4
4	0.3	45	4
5	0.3	61	5
6	0.5	46	4
7	0.5	74	3
8	1.2	96	5
9	0.5	110	6
10	0.4	110	7
11	0.7	110	5

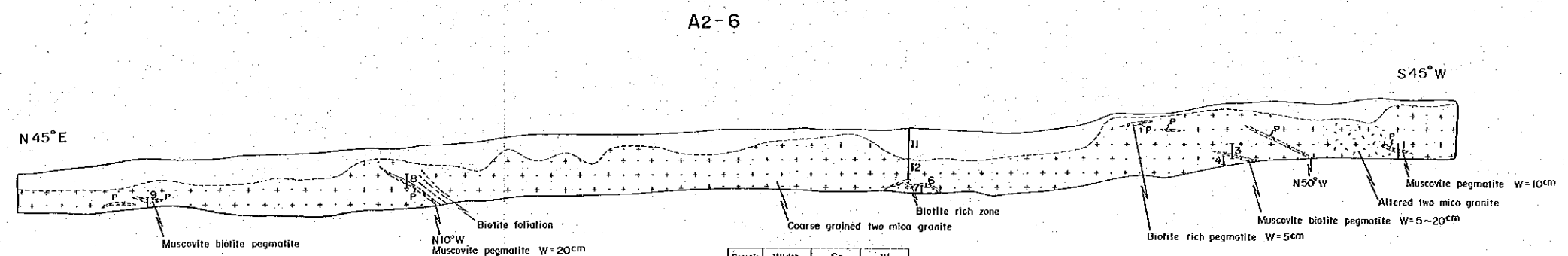

A2-6

Sample No.	Width (m)	Sn (ppm)	W (ppm)
1	0.5	190	11
3	0.5	35	3
4	0.3	170	5
6	0.1	230	5
7	0.3	52	11
8	0.5	90	8
9	0.3	29	4
11	1.0	140	8
12	0.7	120	8

PL. 8
国際協力事業団
15734
図書資料室蔵

GEOLOGICAL SURVEY
OF
THE OMKOI AREA, KINGDOM OF THAILAND
PHASE III
GEOLOGICAL SKETCH OF TRENCH
(A2-4, A2-6)

Scale 1 : 100

JAPAN INTERNATIONAL COOPERATION AGENCY
METAL MINING AGENCY OF JAPAN
May 1986

LEGEND is the same as that of PL.3

A2 - 5

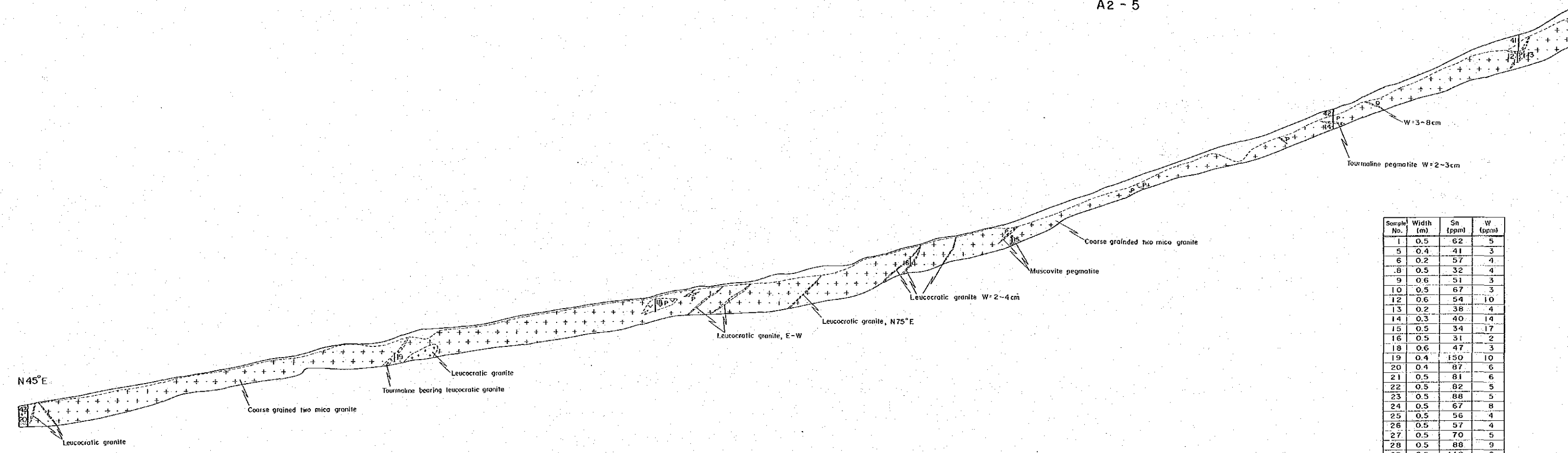

Sample No.	Width (m)	Sn (ppm)	W (ppm)
1	0.5	62	5
5	0.4	41	3
6	0.2	57	4
8	0.5	32	4
9	0.6	51	3
10	0.5	67	3
12	0.6	54	10
13	0.2	38	4
14	0.3	40	14
15	0.5	34	17
16	0.5	31	2
18	0.6	47	3
19	0.4	150	10
20	0.4	87	6
21	0.5	81	6
22	0.5	82	5
23	0.5	88	5
24	0.5	67	8
25	0.5	56	4
26	0.5	57	4
27	0.5	70	5
28	0.5	88	9
29	0.5	110	8
30	0.5	58	5
31	0.5	70	7
32	0.5	72	9
33	0.5	52	6
34	0.5	69	7
35	0.7	76	15
36	0.5	95	10
37	0.5	80	7
38	0.5	66	22
39	0.6	90	22
40	0.5	100	7
41	0.8	70	4
42	0.6	71	6
43	0.6	110	7

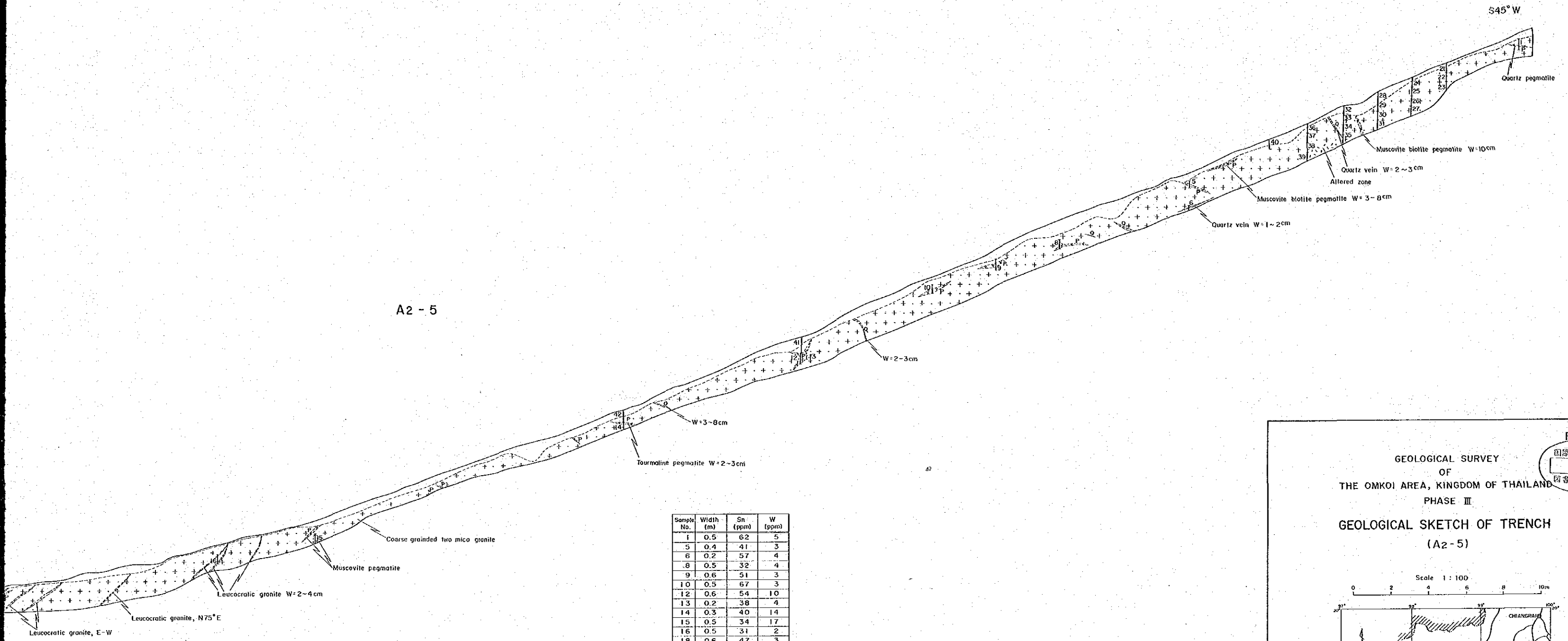

A2 - 5

Sample No.	Width (m)	Sn (ppm)	W (ppm)
1	0.5	62	5
5	0.4	41	3
6	0.2	57	4
8	0.5	32	4
9	0.6	51	3
10	0.5	67	3
12	0.6	54	10
13	0.2	38	4
14	0.3	40	14
15	0.5	34	17
16	0.5	31	2
18	0.6	47	3
19	0.4	150	10
20	0.4	87	6
21	0.5	81	6
22	0.5	82	5
23	0.5	88	5
24	0.5	67	8
25	0.5	56	4
26	0.5	57	4
27	0.5	70	5
28	0.5	88	9
29	0.5	110	8
30	0.5	58	5
31	0.5	70	7
32	0.5	72	9
33	0.5	52	6
34	0.5	69	7
35	0.7	76	15
36	0.5	95	10
37	0.5	80	7
38	0.5	66	22
39	0.6	90	22
40	0.5	100	7
41	0.8	70	4
42	0.6	71	6
43	0.6	110	7

PL 9
 国際協力事業団
 15734
 図書次郎室蔵書

GEOLOGICAL SURVEY
 OF
 THE OMKOI AREA, KINGDOM OF THAILAND
 PHASE III
 GEOLOGICAL SKETCH OF TRENCH
 (A2-5)

Scale 1:100

JAPAN INTERNATIONAL COOPERATION AGENCY
 METAL MINING AGENCY OF JAPAN
 May 1986

LEGEND is the same as that of PL.3

国际協力事業
15734
調査資料室蔵書

GEOLOGICAL SKETCH OF TRENCH
(B1-1, B1-2, B1-3, B1-4, B1-5)

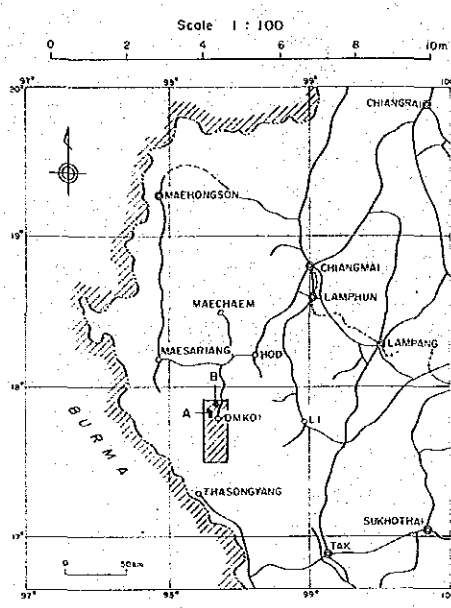

JAPAN INTERNATIONAL COOPERATION AGENCY
METAL MINING AGENCY OF JAPAN

May 1986

B1-1

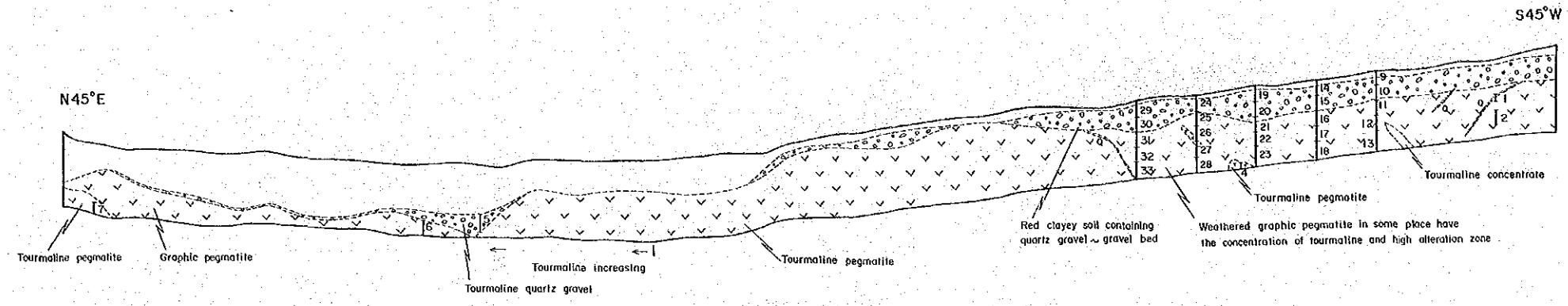

Sample No.	Width (m)	Nb (ppm)	Ta (ppm)
1	0.2	17	7
2	0.5	27	14
4	0.2	26	10
5	0.5	21	9
6	0.5	29	13
7	0.3	21	14
9	0.5	33	14
10	0.5	18	6
11	0.5	36	15
12	0.5	28	11
13	0.6	18	9
14	0.5	22	8
15	0.5	20	7
16	0.5	25	9
17	0.5	16	5
18	0.6	20	6
19	0.5	34	13
20	0.5	26	8
21	0.5	23	7
22	0.5	17	5
23	0.7	19	10
24	0.5	22	7
25	0.5	17	5
26	0.5	13	4
27	0.5	13	3
28	0.6	11	4
29	0.5	26	11
30	0.5	11	3
31	0.5	5	1
32	0.5	7	1
33	0.7	18	7

B1-2

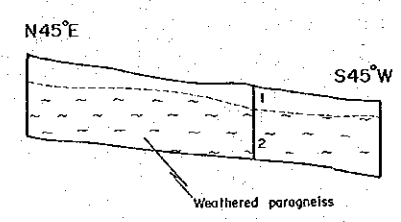

Sample No.	Width (m)	Nb (ppm)	Ta (ppm)
1	0.5	25	8
2	1.3	20	4

B1-3

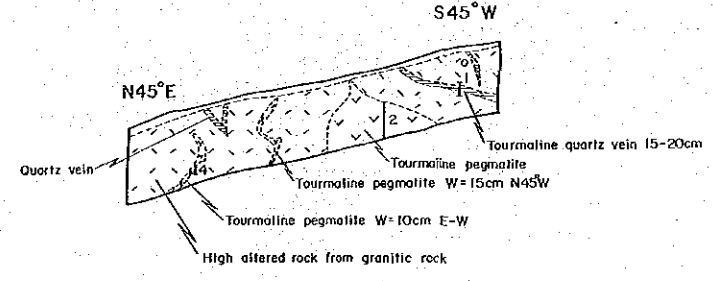

Sample No.	Width (m)	Nb (ppm)	Ta (ppm)
1	0.4	25	10
2	1.0	30	10
4	0.1	49	14

B1-4

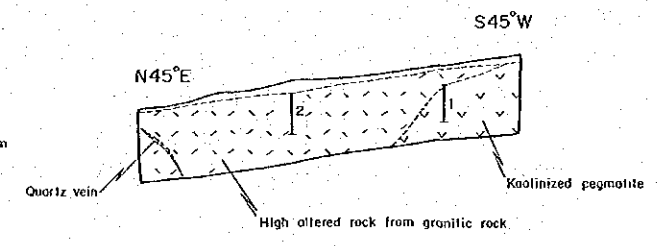

Sample No.	Width (m)	Nb (ppm)	Ta (ppm)
1	1.0	19	8
2	1.2	38	13

B1-5

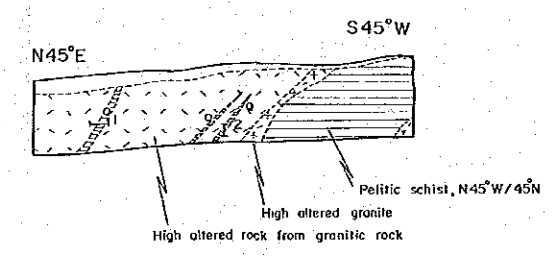

Sample No.	Width (m)	Nb (ppm)	Ta (ppm)
1	0.5	14	2
2	0.3	18	2

LEGEND is the same as that of PL.3

B1-6

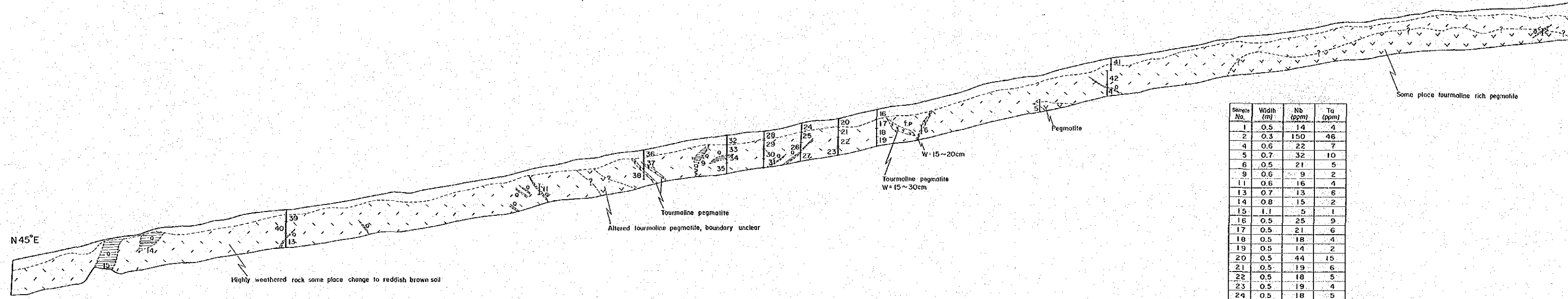

Sample No.	Width (m)	Nb (ppm)	Ta (ppm)
1	0.5	14	4
2	0.3	150	46
4	0.6	22	7
5	0.7	32	10
6	0.5	21	5
9	0.6	9	2
11	0.6	16	4
13	0.7	13	6
14	0.8	15	2
15	1.1	5	1
16	0.5	25	9
17	0.5	21	6
18	0.5	18	4
19	0.5	14	2
20	0.5	44	15
21	0.5	19	6
22	0.5	18	5
23	0.5	19	4
24	0.5	18	5
25	0.5	18	4
26	0.5	15	3
27	0.5	17	5
28	0.5	33	12
29	0.5	22	8
30	0.5	16	3
31	0.5	15	4
32	0.5	24	7
33	0.5	18	6
34	0.5	20	7
35	0.5	9	2
36	0.4	20	5
37	0.6	15	3
38	0.7	14	2
39	0.6	33	12
40	0.6	30	11
41	0.6	29	10
42	0.7	20	6
43	0.6	37	12
44	0.8	27	9
45	0.5	23	8

B1-10

B1-7

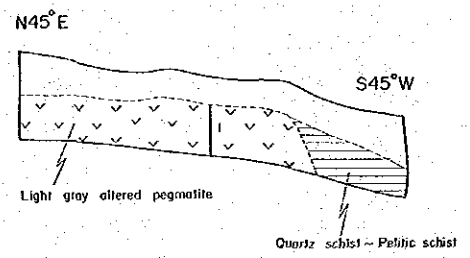

Sample No.	Width (m)	Nb (ppm)	Ta (ppm)
1	1.4	42	14

B1-8

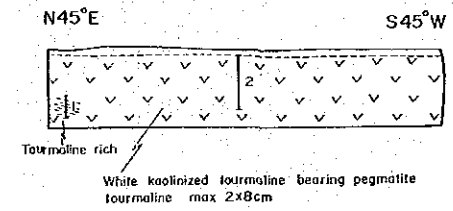

Sample No.	Width (m)	Nb (ppm)	Ta (ppm)
1	0.6	45	17
2	1.8	31	9

B1-9

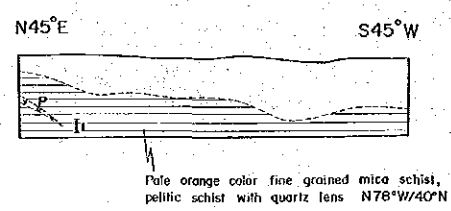

Sample No.	Width (m)	Nb (ppm)	Ta (ppm)
1	0.3	13	3

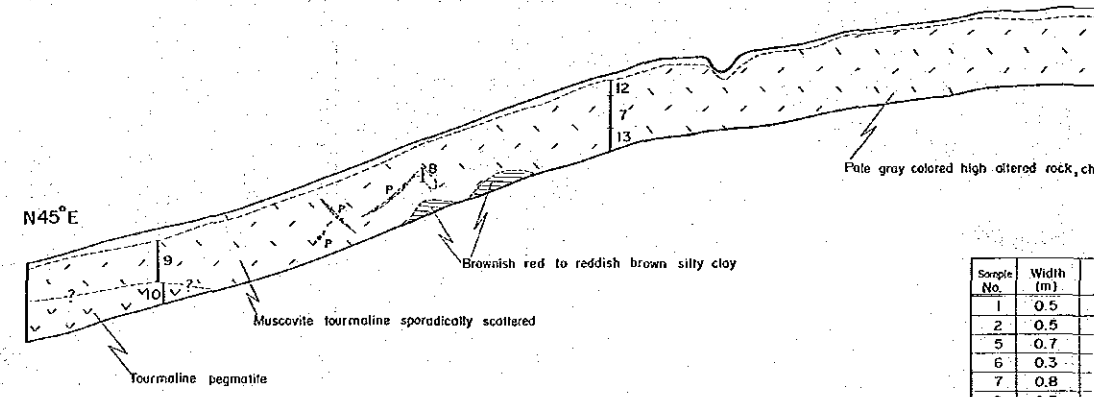

Sample No.	Width (m)
1	0.5
2	0.5
5	0.7
6	0.3
7	0.8
8	0.3
9	1.0
10	0.7
11	0.9
12	0.4
13	0.5

GEOLOGICAL SKETCH OF TRENCH (B1-6, B1-7, B1-8, B1-9, B1-10)

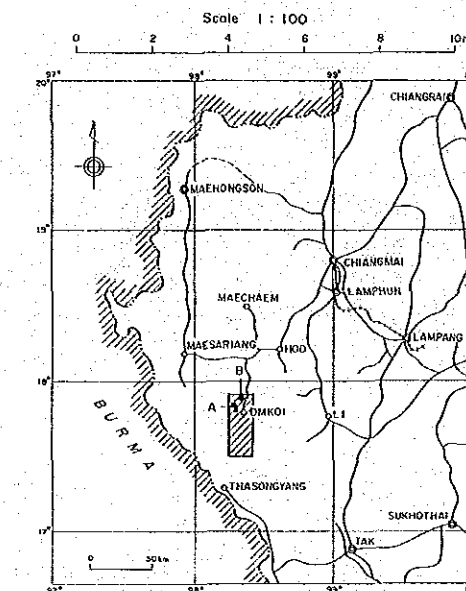

JAPAN INTERNATIONAL COOPERATION AGENCY
 METAL MINING AGENCY OF JAPAN

May 1986

B1-6

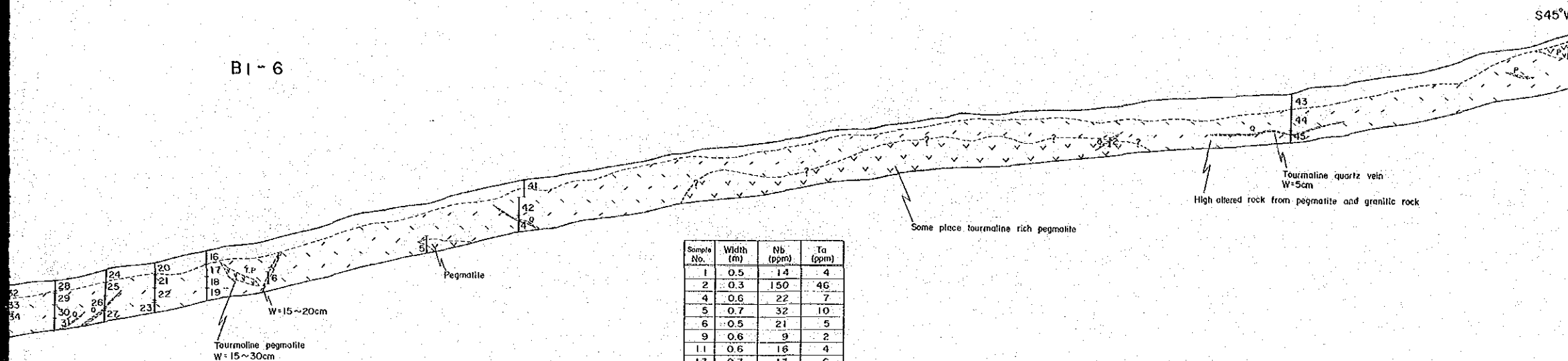

Sample No.	Width (m)	Nb (ppm)	Ta (ppm)
1	0.5	14	4
2	0.3	150	46
4	0.6	22	7
5	0.7	32	10
6	0.5	21	5
9	0.6	9	2
11	0.6	16	4
13	0.7	13	6
14	0.8	15	2
15	1.1	5	1
16	0.5	25	9
17	0.5	21	6
18	0.5	18	4
19	0.5	14	2
20	0.5	44	15
21	0.5	19	6
22	0.5	18	5
23	0.5	19	4
24	0.5	18	5
25	0.5	16	4
26	0.5	15	3
27	0.5	17	5
28	0.5	33	12
29	0.5	22	8
30	0.5	16	3
31	0.5	15	4
32	0.5	24	7
33	0.5	18	6
34	0.5	20	7
35	0.5	9	2
36	0.4	20	5
37	0.6	15	3
38	0.7	14	2
39	0.6	33	12
40	0.6	30	11
41	0.6	29	10
42	0.7	20	6
43	0.6	37	12
44	0.8	27	9
45	0.5	23	8

B1-10

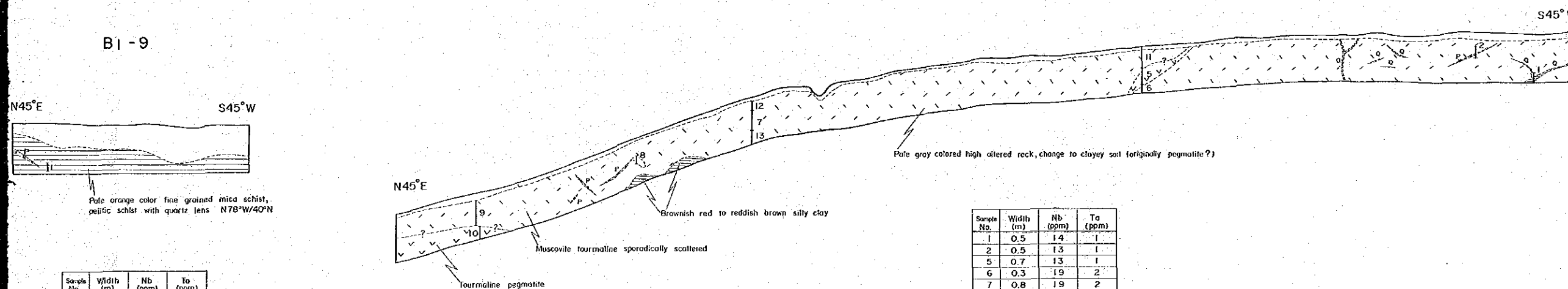

Sample No.	Width (m)	Nb (ppm)	Ta (ppm)
1	0.5	14	1
2	0.5	13	1
5	0.7	13	1
6	0.3	19	2
7	0.8	19	2
8	0.3	14	1
9	1.0	18	2
10	0.7	18	2
11	0.9	22	4
12	0.4	17	2
13	0.5	11	1

Sample No.	Width (m)	Nb (ppm)	Ta (ppm)
1	0.3	13	3

LEGEND is the same as that of PL.3

B2-1

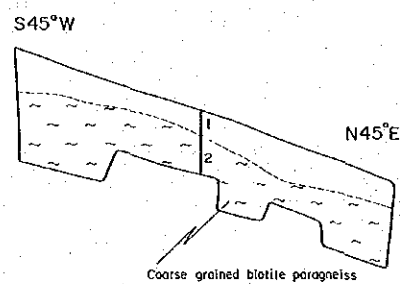

Sample No.	Width (m)	Sn (ppm)	W (ppm)
1	0.5	15	24
2	1.2	18	43

B2-2

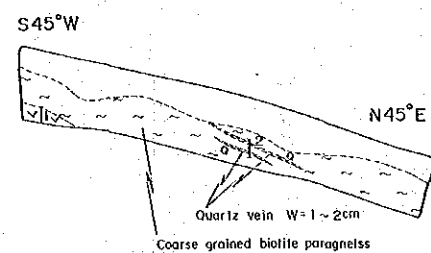

Sample No.	Width (m)	Sn (ppm)	W (ppm)
1	0.4	18	40
2	0.5	9	44

B2-3

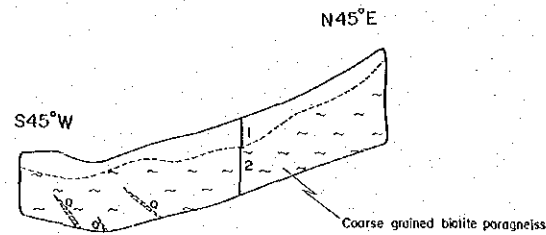

Sample No.	Width (m)	Sn (ppm)	W (ppm)
1	0.5	51	120
2	1.5	46	55

B2-4

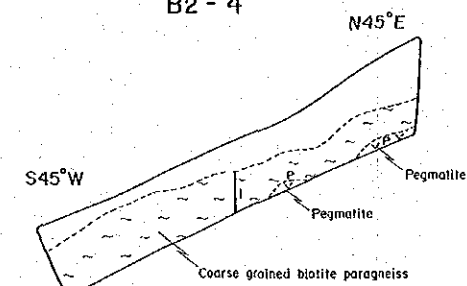

Sample No.	Width (m)	Sn (ppm)	W (ppm)
1	1.0	15	11

Sample No.	Width (m)	Sn (ppm)	W (ppm)
1	1.0	22	13
2	0.4	20	26
3	0.3	16	14
4	0.3	21	22
5	0.3	21	19
7	0.2	9	12
8	0.3	32	16
11	0.2	31	25
12	0.2	60	16
13	0.3	9	11
15	0.2	49	860
17	0.2	8	46
18	0.3	30	68
19	0.3	29	30
20	0.3	18	46
21	0.2	13	44
22	0.5	37	110
23	0.5	42	64
24	0.5	41	49
25	0.5	47	34
26	0.3	40	27
27	0.5	40	72
28	0.5	41	59
29	0.5	40	35
30	0.3	49	26
31	0.5	41	88
32	0.5	39	69
33	0.5	44	42
34	0.4	36	22
35	0.5	40	100
36	0.5	40	91
37	0.5	44	72
38	0.4	30	19
39	0.5	44	93
40	0.5	32	68
41	0.5	34	64
42	0.3	13	23
23'	0.5	12	26
24'	0.4	7	100
25'	0.5	29	110

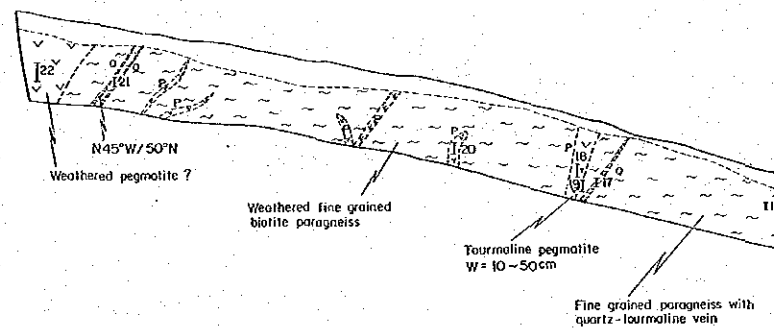
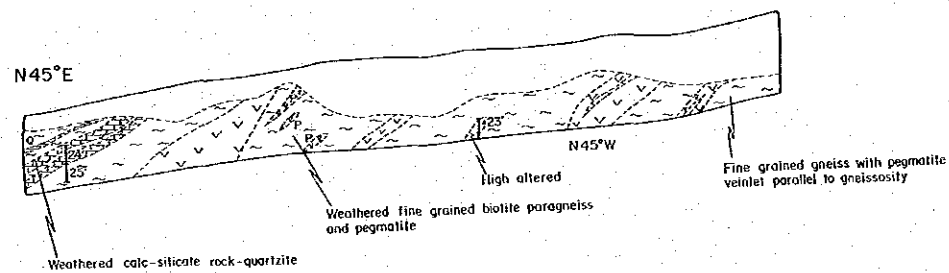

B2-5

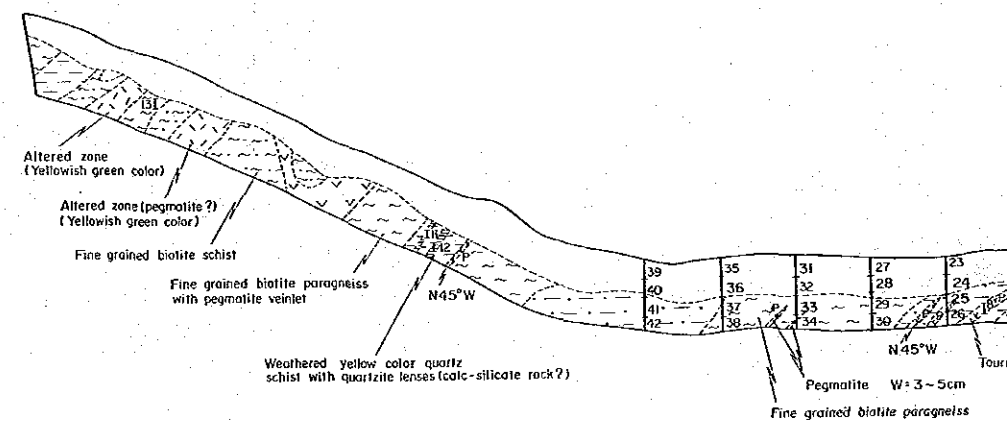

GEOLOGICAL SURVEY
OF
THE OMKOI AREA, KINGDOM OF THAILAND
PHASE III
GEOLOGICAL SKETCH OF TRENCH
(B2-1, B2-2, B2-3, B2-4, B2-5)

国務協力事業団
15734
国書資料室蔵書

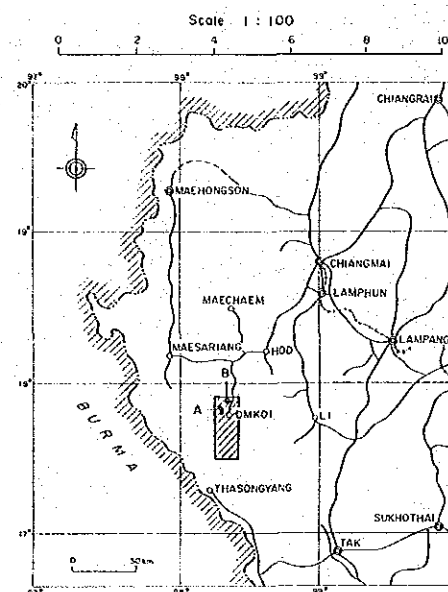

JAPAN INTERNATIONAL COOPERATION AGENCY
METAL MINING AGENCY OF JAPAN

May 1986

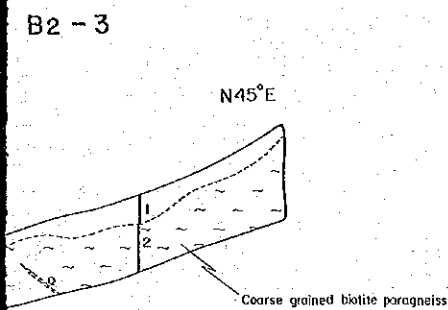

Sample No.	Width (m)	Sn (ppm)	W (ppm)
1	0.5	51	120
2	1.5	46	55

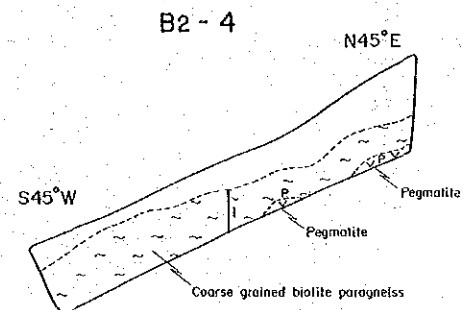

Sample No.	Width (m)	Sn (ppm)	W (ppm)
1	1.0	15	11

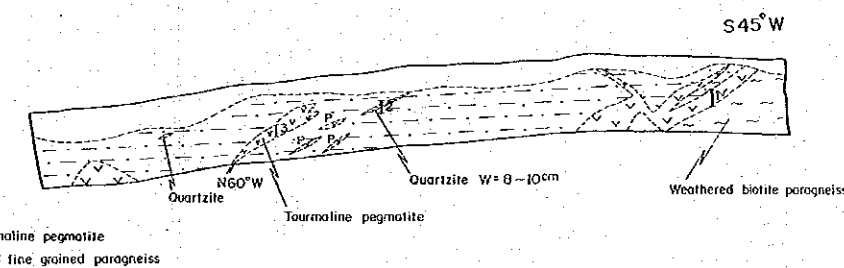
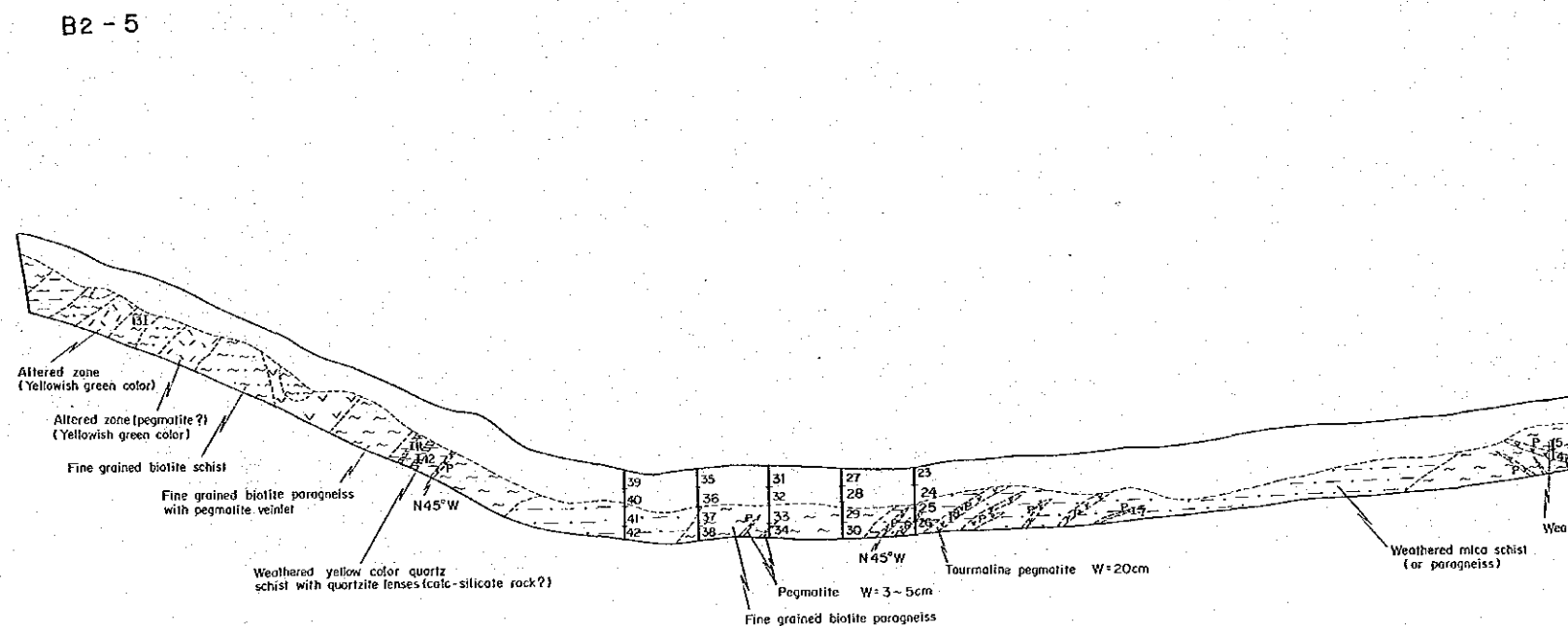
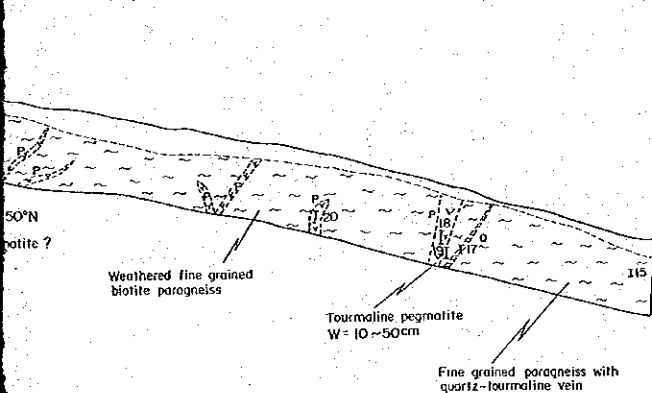

LEGEND is the same as that of PL.3

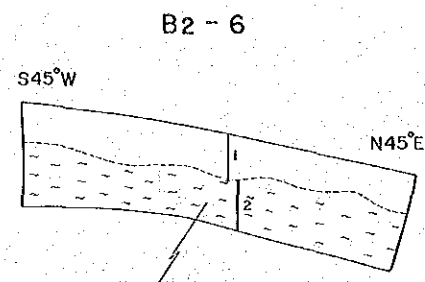

Sample No.	Width (m)	Sn (ppm)	W (ppm)
1	1.2	13	26
2	1.3	20	49

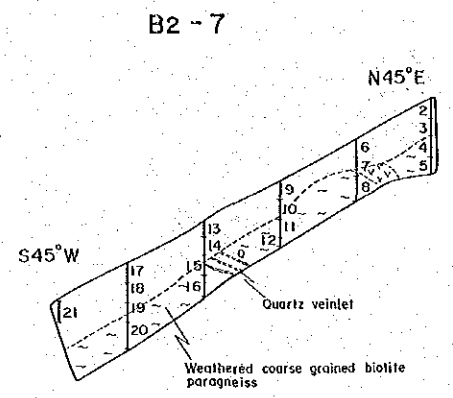

Sample No.	Width (m)	Sn (ppm)	W (ppm)
2	0.5	32	80
3	0.5	39	78
4	0.5	28	30
5	0.4	35	23
6	0.5	35	87
7	0.5	33	74
8	0.6	30	32
9	0.5	31	75
10	0.5	20	31
11	0.5	21	30
12	0.2	17	16
13	0.5	35	92
14	0.5	31	62
15	0.5	24	33
16	0.4	16	17
17	0.5	35	80
18	0.5	33	37
19	0.5	36	54
20	0.7	36	18
21	0.5	42	100

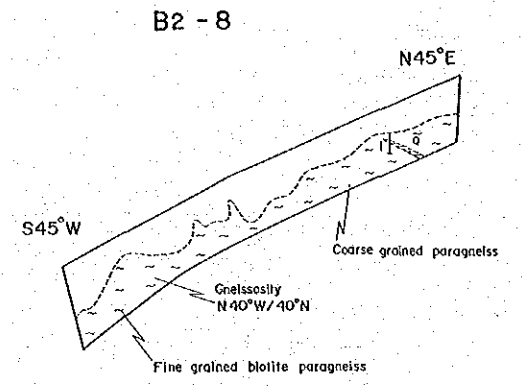

Sample No.	Width (m)	Sn (ppm)	W (ppm)
1	0.5	9	12

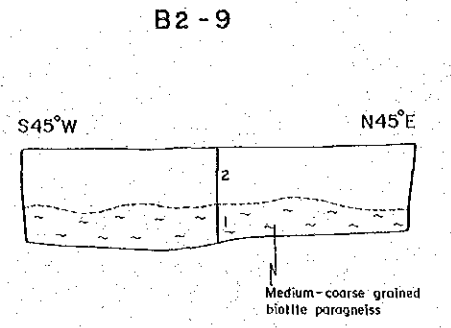

Sample No.	Width (m)	Sn (ppm)	W (ppm)
1	1.0	14	7
2	1.5	16	11

B2 - 10

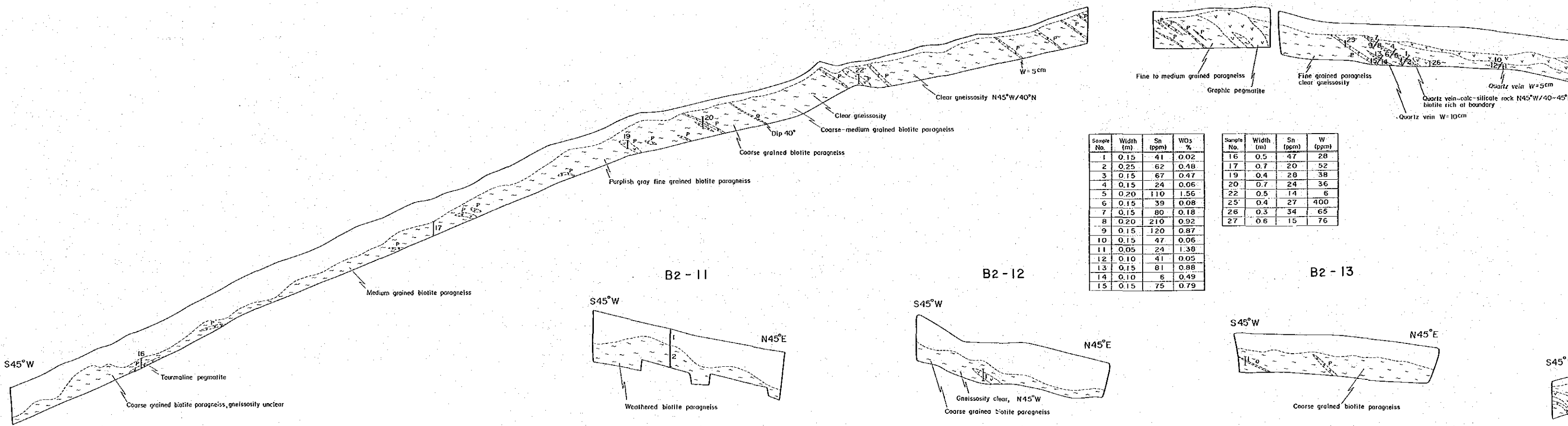

Sample No.	Width (m)	Sn (ppm)	WO ₃ %
1	0.15	41	0.02
2	0.25	62	0.48
3	0.15	67	0.47
4	0.15	24	0.06
5	0.20	110	1.56
6	0.15	39	0.08
7	0.15	80	0.18
8	0.20	210	0.92
9	0.15	120	0.87
10	0.15	47	0.06
11	0.05	24	1.38
12	0.10	41	0.05
13	0.15	81	0.88
14	0.10	6	0.49
15	0.15	75	0.79

Sample No.	Width (m)	Sn (ppm)	W (ppm)
16	0.5	47	28
17	0.7	20	52
19	0.4	28	38
20	0.7	24	36
22	0.5	14	6
25	0.4	27	400
26	0.3	34	65
27	0.6	15	76

B2 - 11

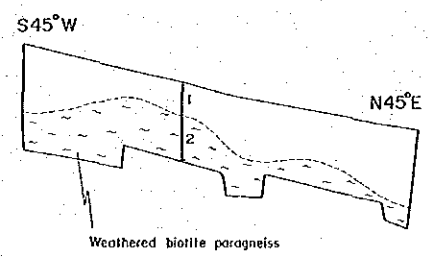

Sample No.	Width (m)	Sn (ppm)	W (ppm)
1	0.9	94	560
2	1.2	120	650

B2 - 12

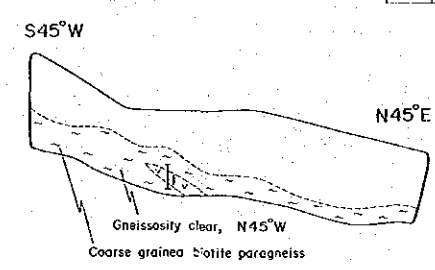

Sample No.	Width (m)	Sn (ppm)	W (ppm)
1	0.6	22	32

B2 - 13

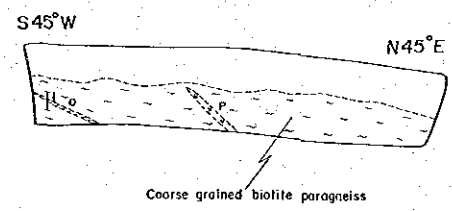

Sample No.	Width (m)	Sn (ppm)	W (ppm)
1	0.5	10	64

GEOLOGICAL SKETCH OF TRENCH

(B2-6, B2-7, B2-8, B2-9, B2-10, B2-11, B2-12, B2-13, B2-14)

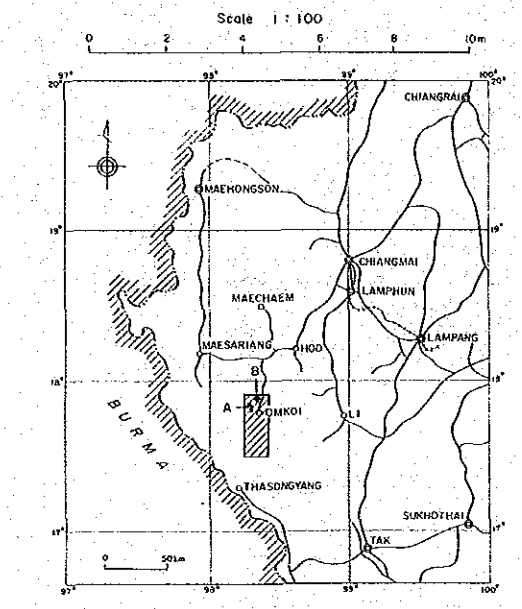

JAPAN INTERNATIONAL COOPERATION AGENCY
METAL MINING AGENCY OF JAPAN

May 1986

B2-7

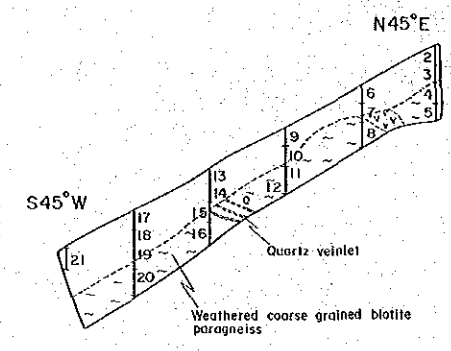

Sample No.	Width (m)	Sn (ppm)	W (ppm)
2	0.5	32	80
3	0.5	39	78
4	0.5	28	30
5	0.4	33	23
6	0.5	35	87
7	0.5	33	74
8	0.6	30	32
9	0.5	31	75
10	0.5	20	31
11	0.5	21	30
12	0.2	17	16
13	0.5	35	92
14	0.5	31	62
15	0.5	29	33
16	0.4	16	17
17	0.5	35	80
18	0.5	33	37
19	0.5	36	54
20	0.7	36	18
21	0.5	42	100

B2-8

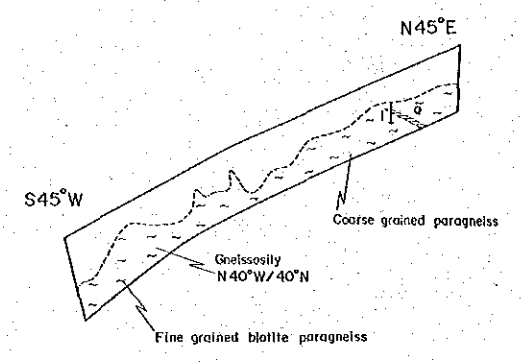

Sample No.	Width (m)	Sn (ppm)	W (ppm)
1	0.5	9	12

B2-9

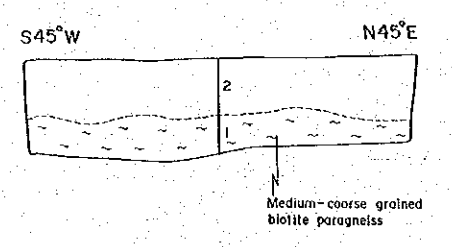

Sample No.	Width (m)	Sn (ppm)	W (ppm)
1	1.0	14	7
2	1.5	16	11

B2-10

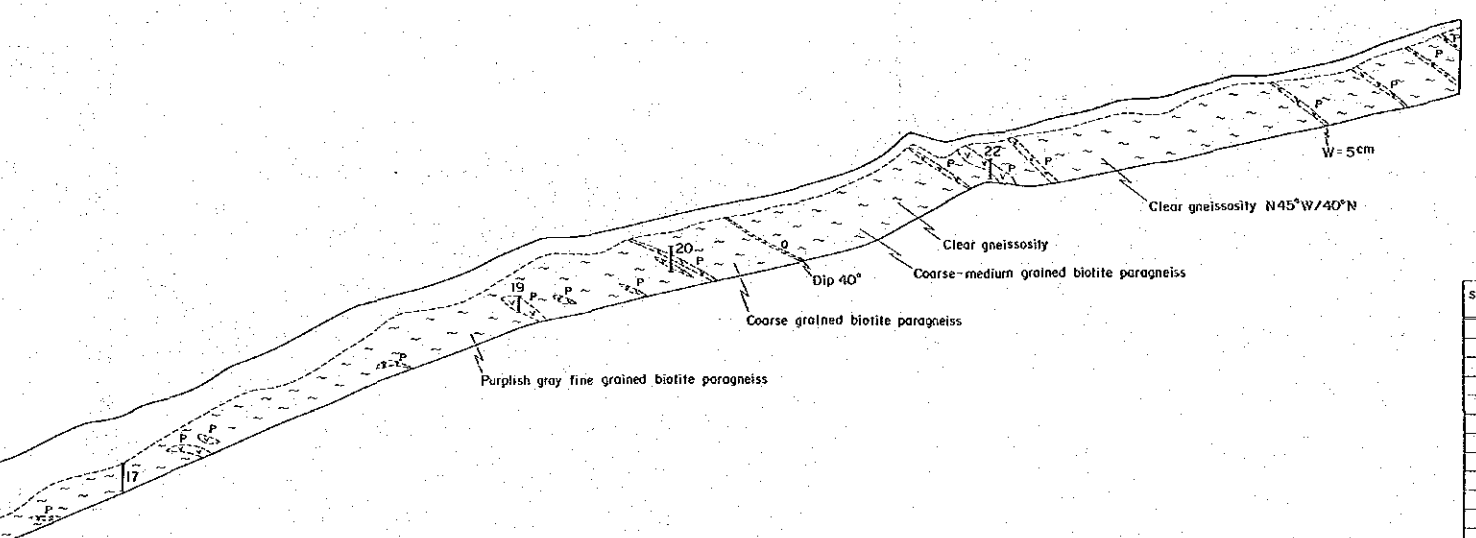

Sample No.	Width (m)	Sn (ppm)	W ₀₃ %
1	0.15	41	0.02
2	0.25	62	0.48
3	0.15	67	0.47
4	0.15	24	0.06
5	0.20	110	1.56
6	0.15	39	0.08
7	0.15	80	0.18
8	0.20	210	0.92
9	0.15	120	0.87
10	0.15	47	0.06
11	0.05	24	1.38
12	0.10	41	0.05
13	0.15	91	0.88
14	0.10	6	0.49
15	0.15	75	0.79

Sample No.	Width (m)	Sn (ppm)	W (ppm)
16	0.5	47	28
17	0.7	20	52
19	0.4	28	38
20	0.7	24	36
22	0.5	14	6
25	0.4	27	400
26	0.3	34	65
27	0.6	15	76

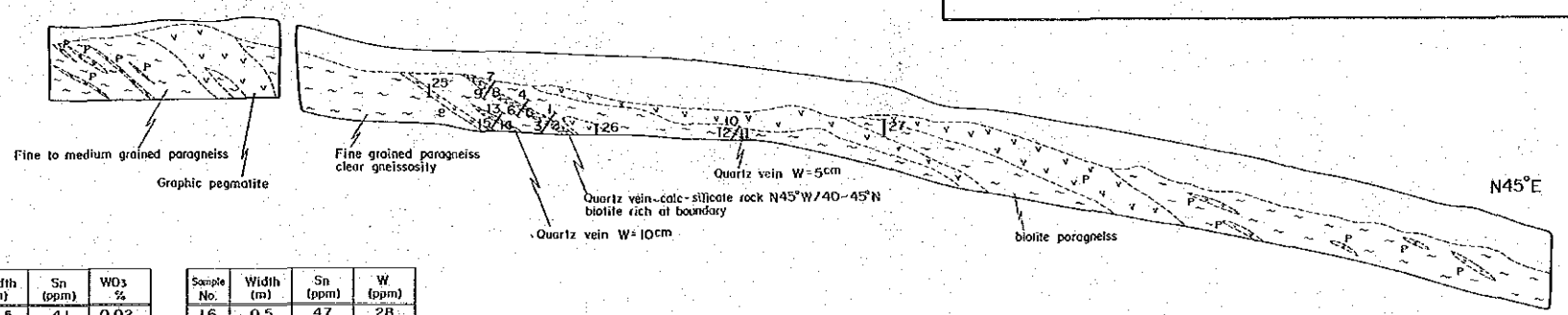

B2-11

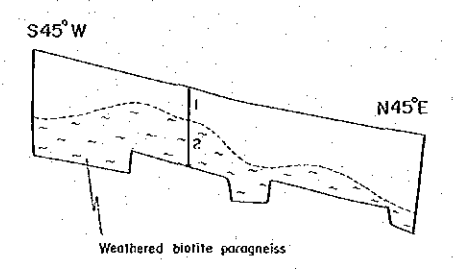

Sample No.	Width (m)	Sn (ppm)	W (ppm)
1	0.9	94	560
2	1.2	120	650

B2-12

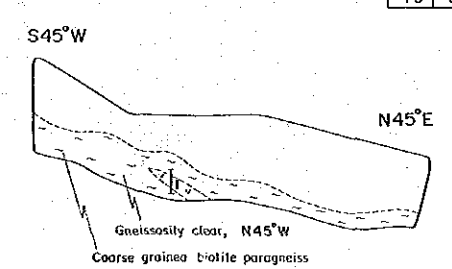

Sample No.	Width (m)	Sn (ppm)	W (ppm)
1	0.6	22	32

B2-13

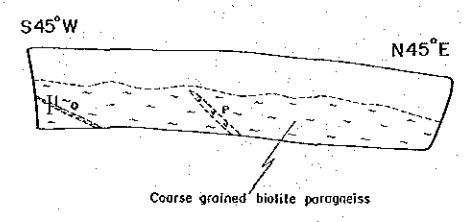

Sample No.	Width (m)	Sn (ppm)	W (ppm)
1	0.5	10	64

B2-14

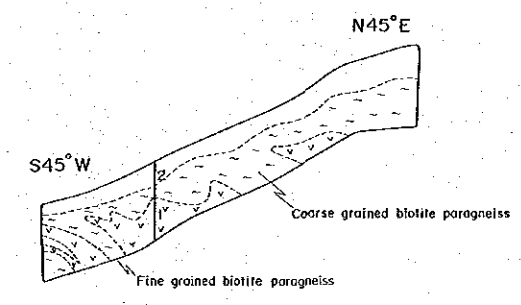

Sample No.	Width (m)	Sn (ppm)	W (ppm)
1	1.1	13	15
2	1.0	21	31

LEGEND is the same as that of PL.3

S45°W

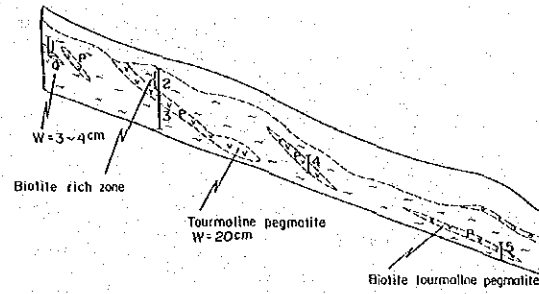

Sample No.	Width (m)	Sn (ppm)	W (ppm)
1	0.7	12	13
2	0.7	34	20
3	0.8	9	7
4	0.5	9	9
5	0.4	20	21
6	1.1	23	59
7	0.4	12	80
8	1.4	12	53
9	0.8	27	100
10	1.2	17	100
11	0.7	29	76
12	1.3	17	50

Fine grained biotite paragneiss

Yellowish brown - reddish brown clayey soil containing angular - subangular quartz and pegmatite gravel

Fine grained biotite paragneiss (or biotite schist)

B2 - 15

B2 - 16

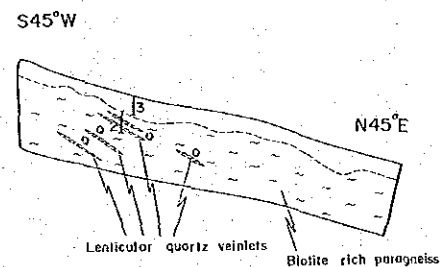

Sample No.	Width (m)	Sn (ppm)	W (ppm)
2	0.8	21	75
3	0.5	37	170

B2 - 17

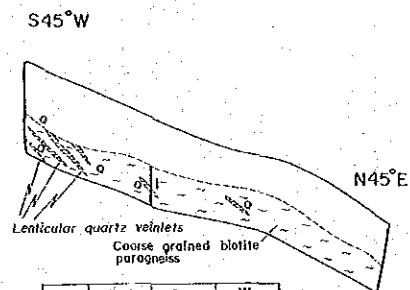

Sample No.	Width (m)	Sn (ppm)	W (ppm)
1	1.0	14	25

B2 - 18

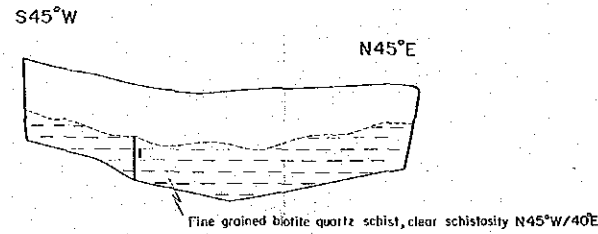

Sample No.	Width (m)	Sn (ppm)	W (ppm)
1	1.1	9	9

Peddish brown clayey soil containing quartz gravel

B2 - 19

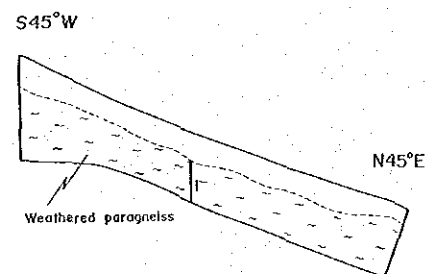

Sample No.	Width (m)	Sn (ppm)	W (ppm)
1	1.0	26	31

B2 - 20

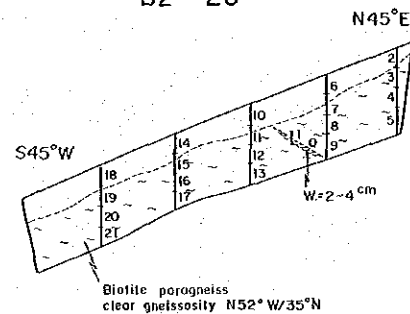

Sample No.	Width (m)	Sn (ppm)	W (ppm)
1	0.3	26	27
2	0.5	33	44
3	0.5	35	26
4	0.5	27	24
5	0.8	25	28
6	0.5	36	48
7	0.5	31	43
8	0.5	34	51
9	0.6	32	27
10	0.5	33	43
11	0.5	41	50
12	0.5	33	28
13	0.6	38	56
14	0.5	28	37
15	0.5	39	56
16	0.5	39	46
17	0.5	29	19
18	0.5	18	29
19	0.5	36	50
20	0.5	41	45
21	0.5	36	34

B2 - 21

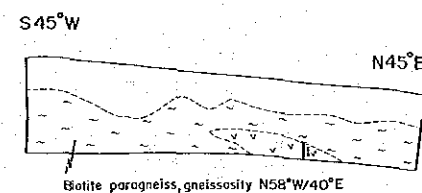

Sample No.	Width (m)	Sn (ppm)	W (ppm)
1	0.4	12	9

B2 - 22

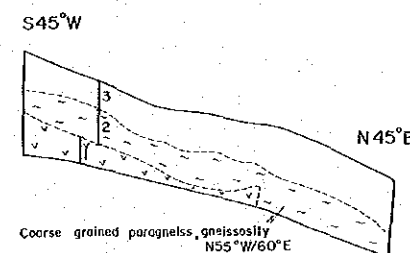

Sample No.	Width (m)	Sn (ppm)	W (ppm)
1	0.7	13	29
2	0.8	19	32
3	0.7	35	59

B2 - 23

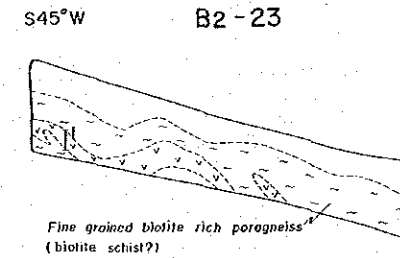

Sample No.	Width (m)	Sn (ppm)	W (ppm)
1	0.5	17	19

GEOLOGICAL SURVEY
 OF
 THE OMKOI AREA, KINGDOM OF THAILAND
 PHASE III
 GEOLOGICAL SKETCH OF TRENCH
 (B2-15, B2-16, B2-17, B2-18, B2-19, B2-20, B2-21, B2-22, B2-23)

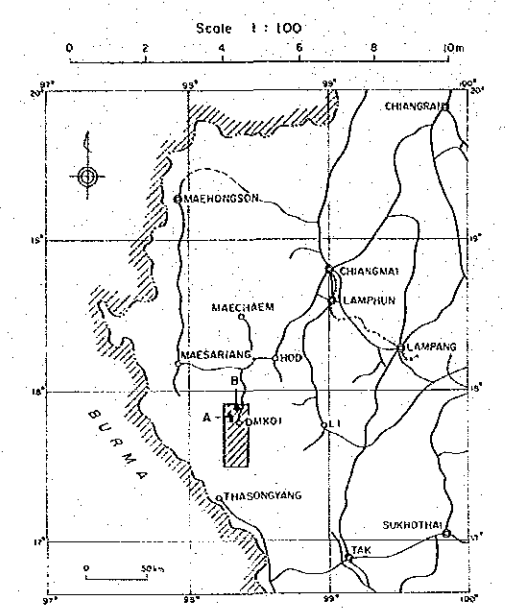

JAPAN INTERNATIONAL COOPERATION AGENCY
 METAL MINING AGENCY OF JAPAN
 May 1986

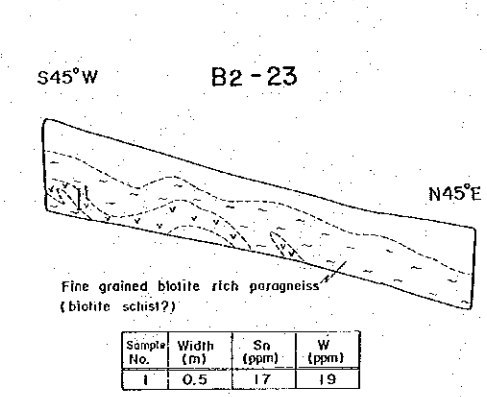
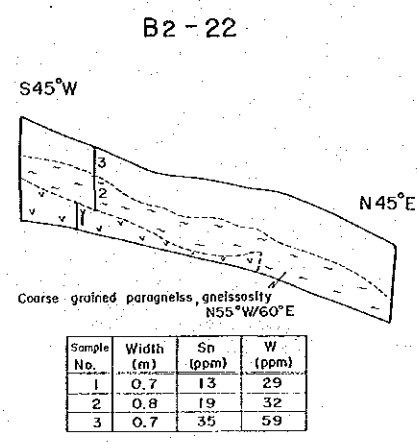
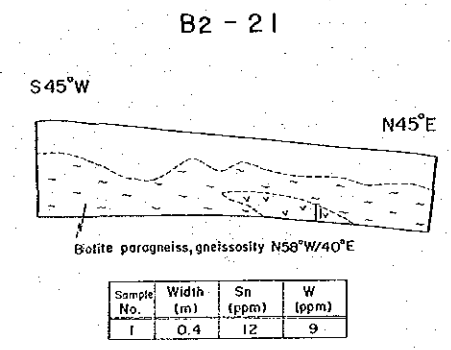
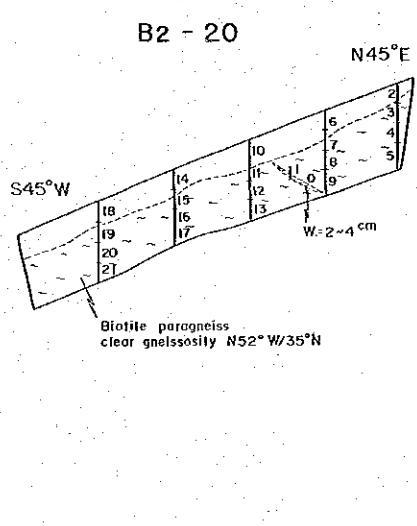
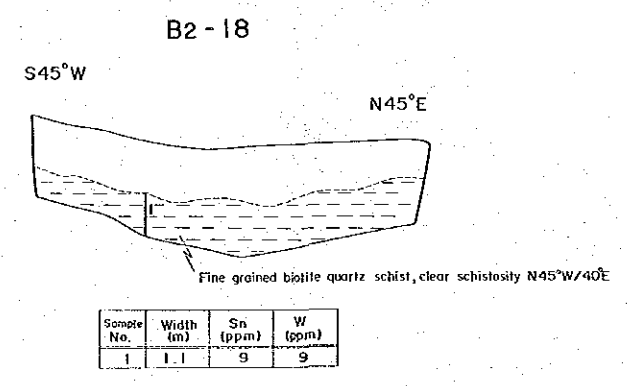
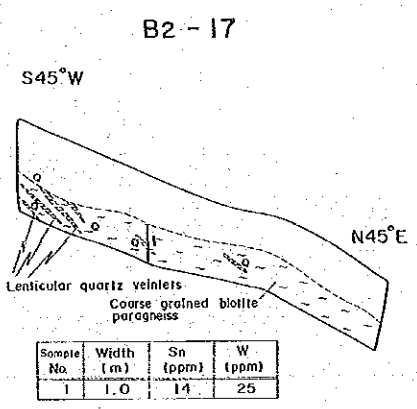
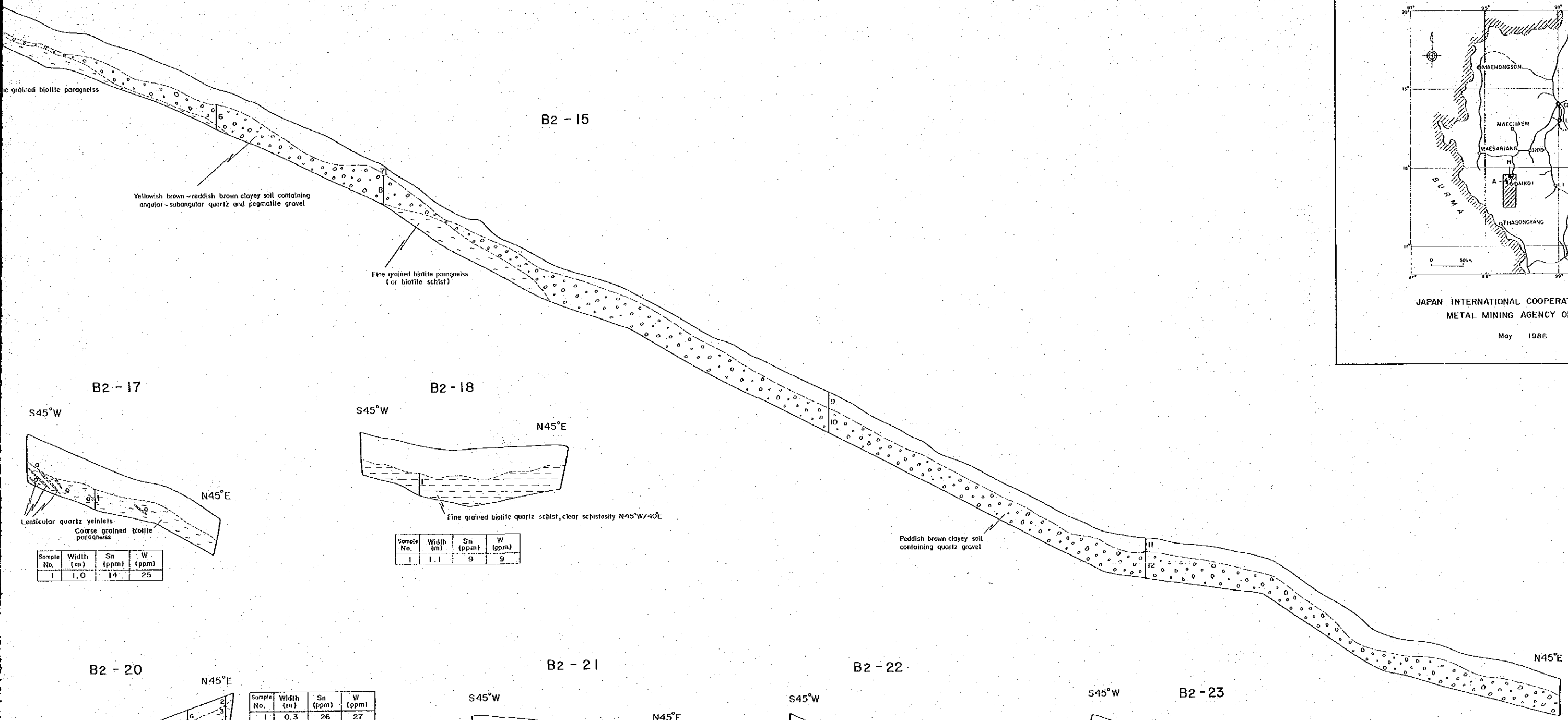

LEGEND is the same as that of PL.3

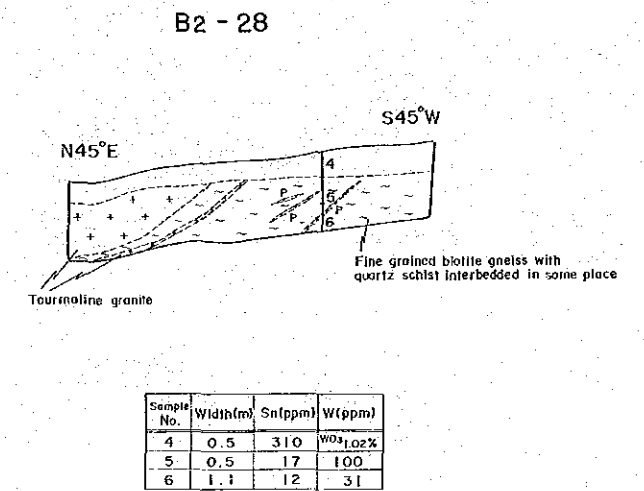
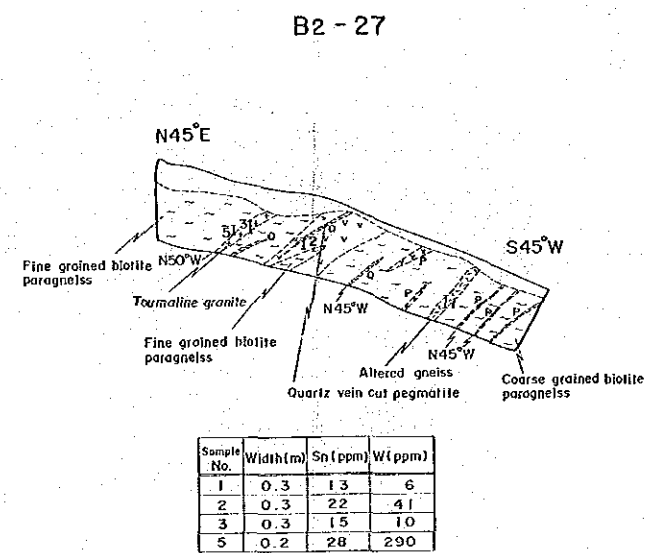
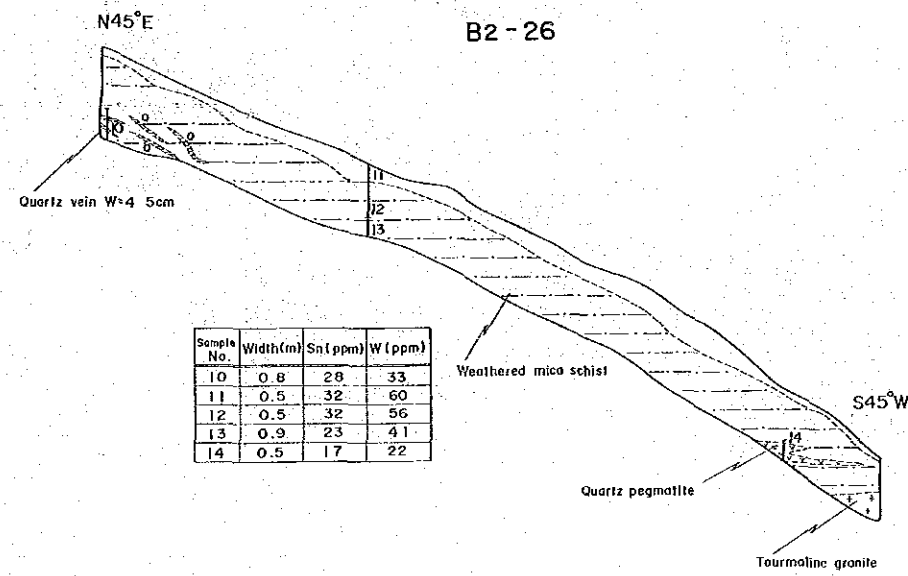
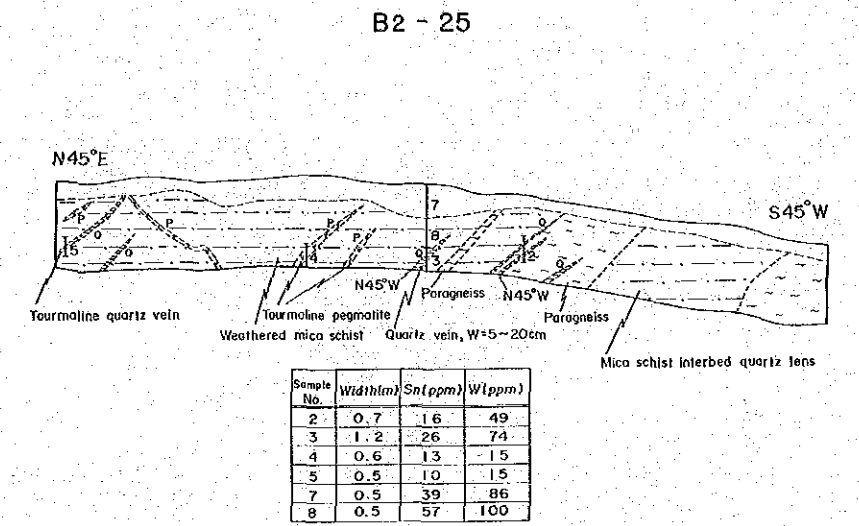
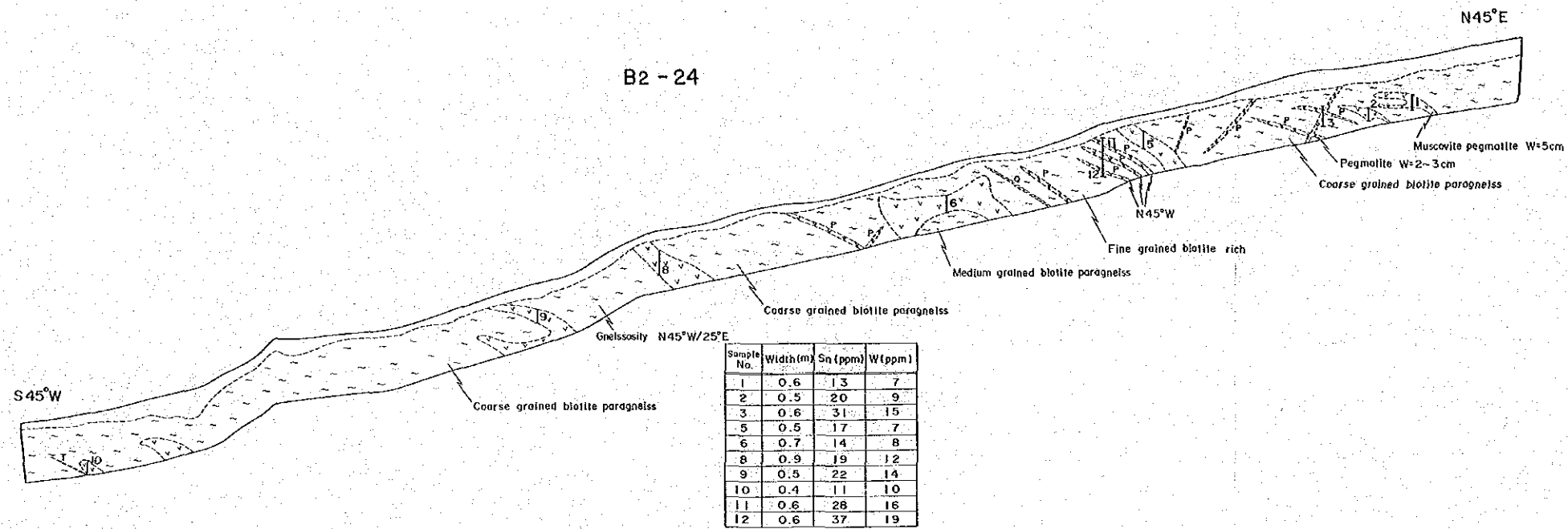

PHASE III
 GEOLOGICAL SKETCH OF TRENCH
 (B2-24, B2-25, B2-26, B2-27, B2-28)

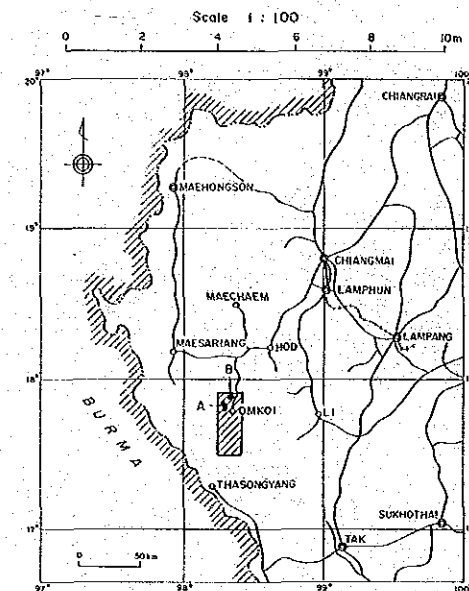

JAPAN INTERNATIONAL COOPERATION AGENCY
 METAL MINING AGENCY OF JAPAN

May 1986

B2 - 24

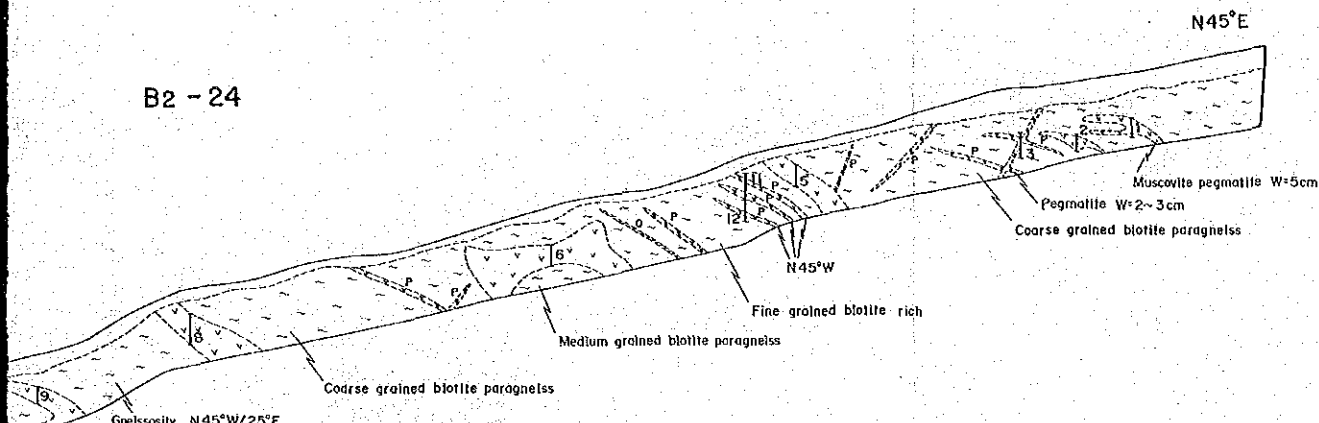

Sample No.	Width(m)	Sn (ppm)	W(ppm)
1	0.6	13	7
2	0.5	20	9
3	0.6	31	15
5	0.5	17	7
6	0.7	14	8
8	0.9	19	12
9	0.5	22	14
10	0.4	11	10
11	0.6	28	16
12	0.6	37	19

B2 - 25

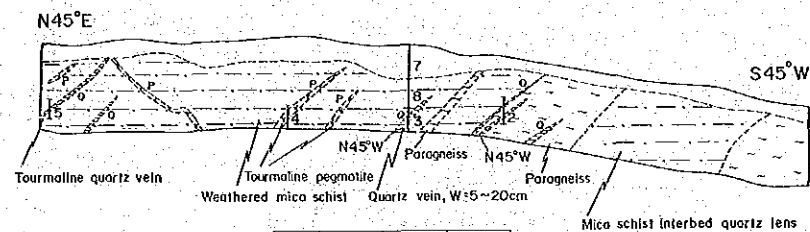

Sample No.	Width(m)	Sn (ppm)	W(ppm)
2	0.7	16	49
3	1.2	26	74
4	0.6	13	15
5	0.5	10	15
7	0.5	39	86
8	0.5	57	100

B2 - 27

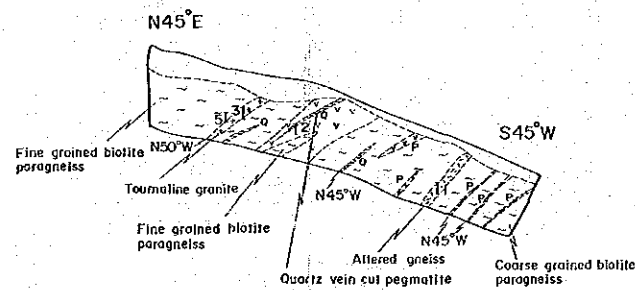

Sample No.	Width(m)	Sn (ppm)	W(ppm)
1	0.3	13	6
2	0.3	22	41
3	0.3	15	10
5	0.2	28	290

B2 - 28

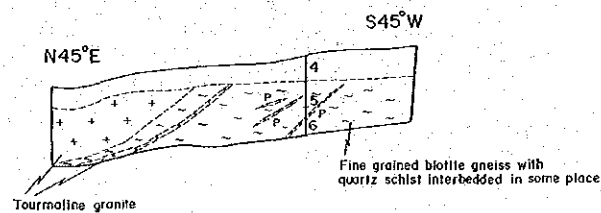

Sample No.	Width(m)	Sn (ppm)	W(ppm)
4	0.5	310	102%
5	0.5	17	100
6	1.1	12	31

LEGEND is the same as that of PL.3

