

GOVERNMENT OF THE REPUBLIC
OF HONDURAS
MINISTRY OF NATURAL RESOURCES
CHOLUTECA RIVER BASIN
AGRICULTURAL DEVELOPMENT PROJECT
JAPAN INTERNATIONAL COOPERATION AGENCY

Fig.

7-3

ORGANIZATION FOR OPERATION

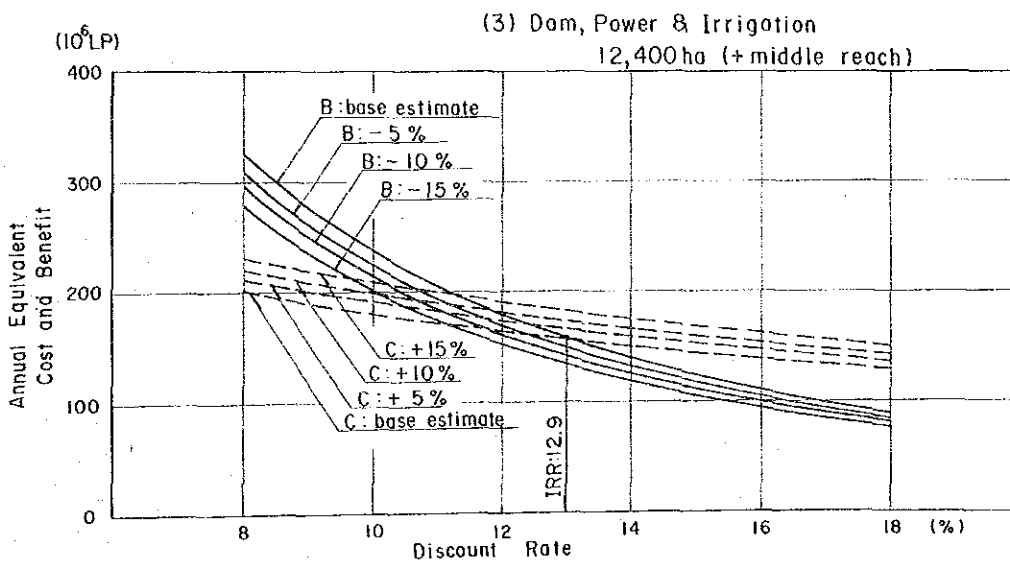
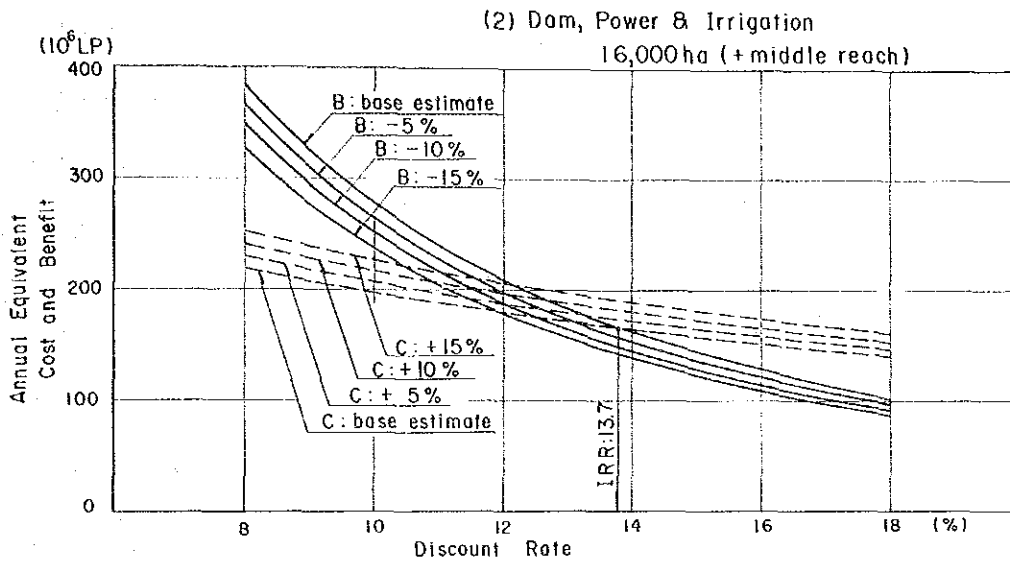
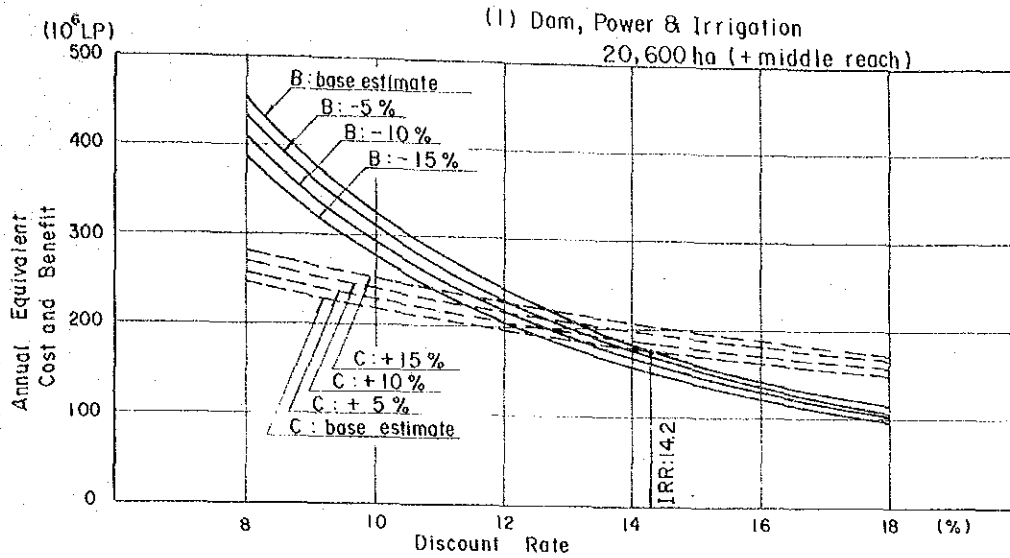

PLANOS

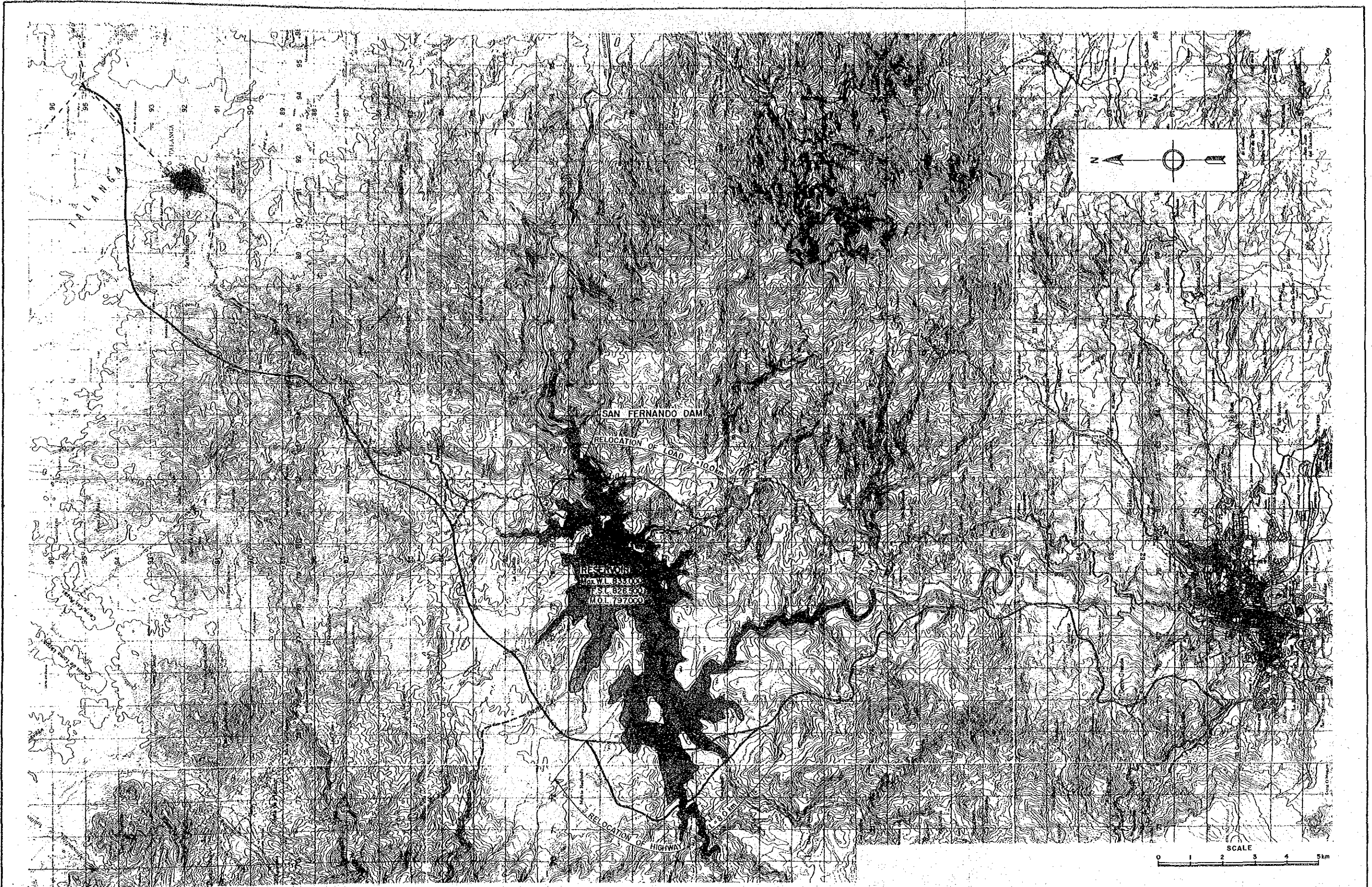

GOVERNMENT OF THE REPUBLIC
 OF HONDURAS
 MINISTRY OF NATURAL RESOURCES
 CHOLUTECA RIVER BASIN
 AGRICULTURAL DEVELOPMENT PROJECT
 JAPAN INTERNATIONAL COOPERATION AGENCY

DWG.
 -01

SAN FERNANDO DAM
 VICINITY MAP

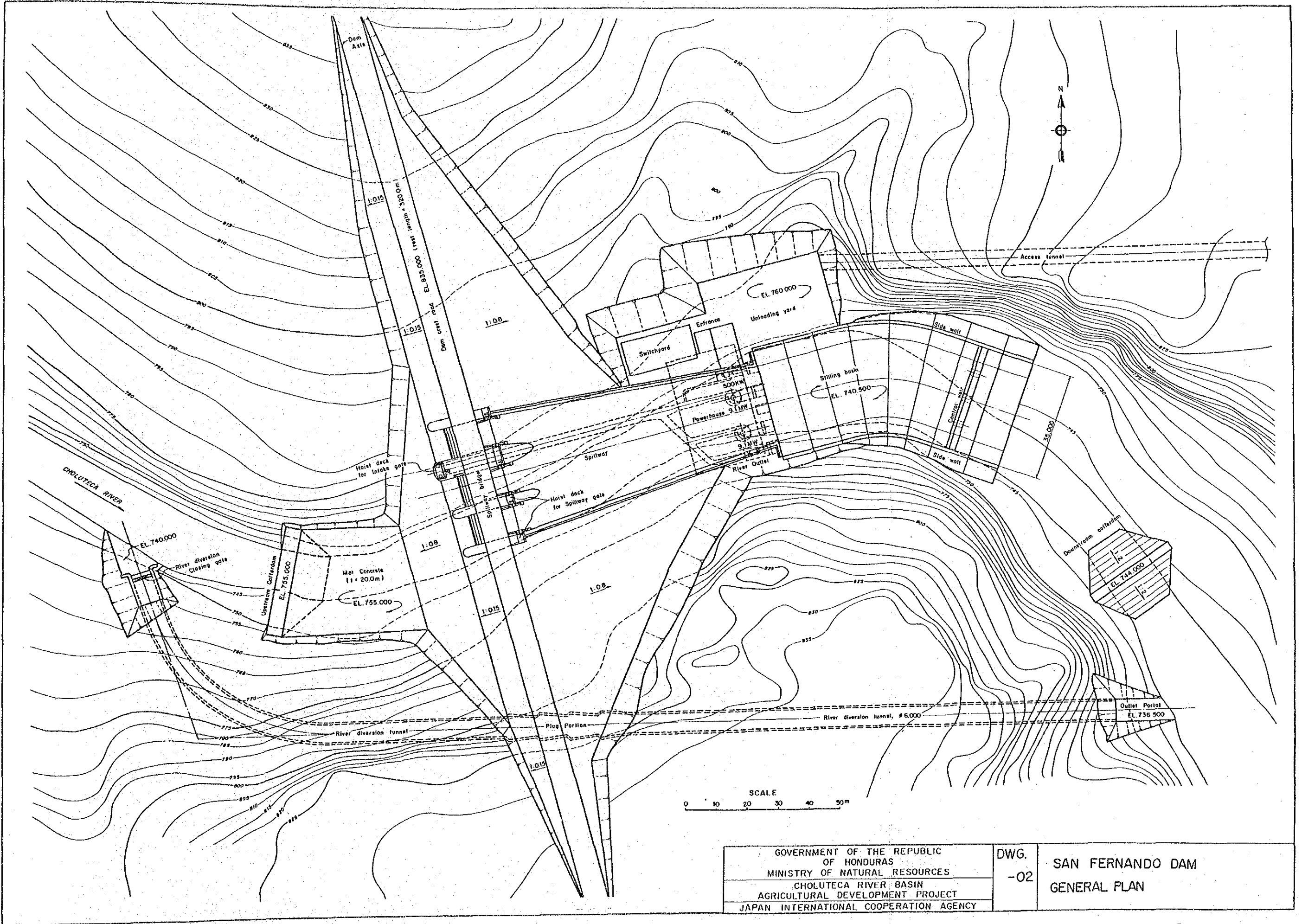

GOVERNMENT OF THE REPUBLIC
 OF HONDURAS
 MINISTRY OF NATURAL RESOURCES
 CHOLUTECA RIVER BASIN
 AGRICULTURAL DEVELOPMENT PROJECT
 JAPAN INTERNATIONAL COOPERATION AGENCY

DWG.
 -02

SAN FERNANDO DAM
 GENERAL PLAN

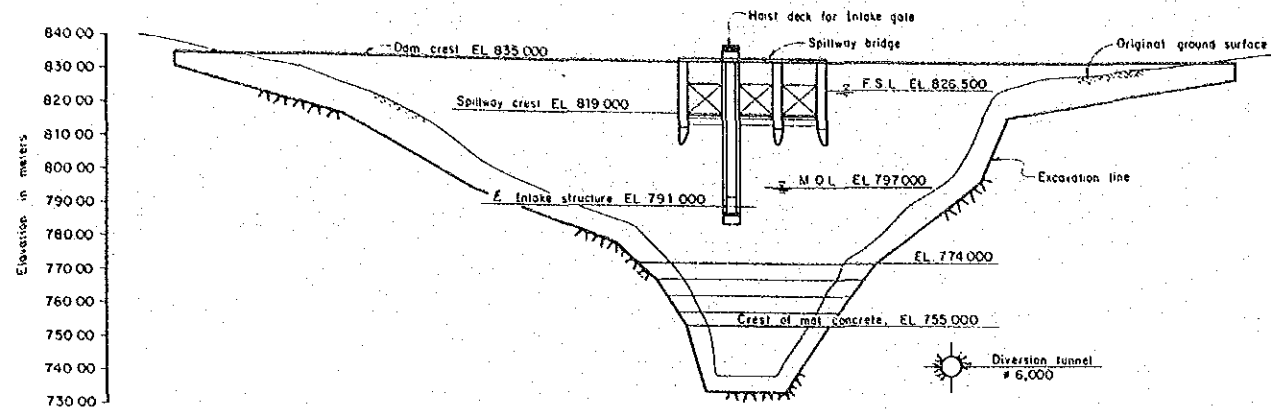

UPSTREAM ELEVATION SCALE A

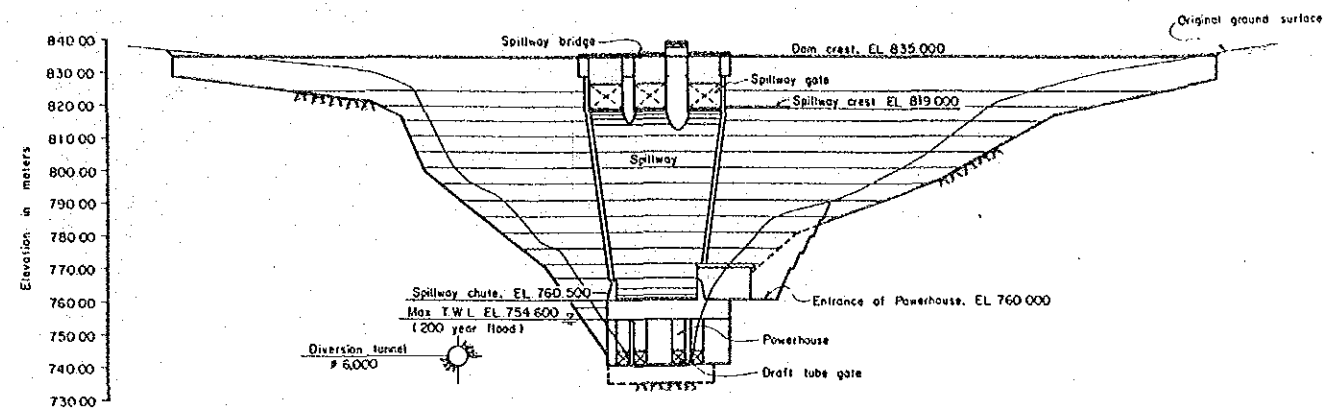

DOWNSTREAM ELEVATION SCALE A

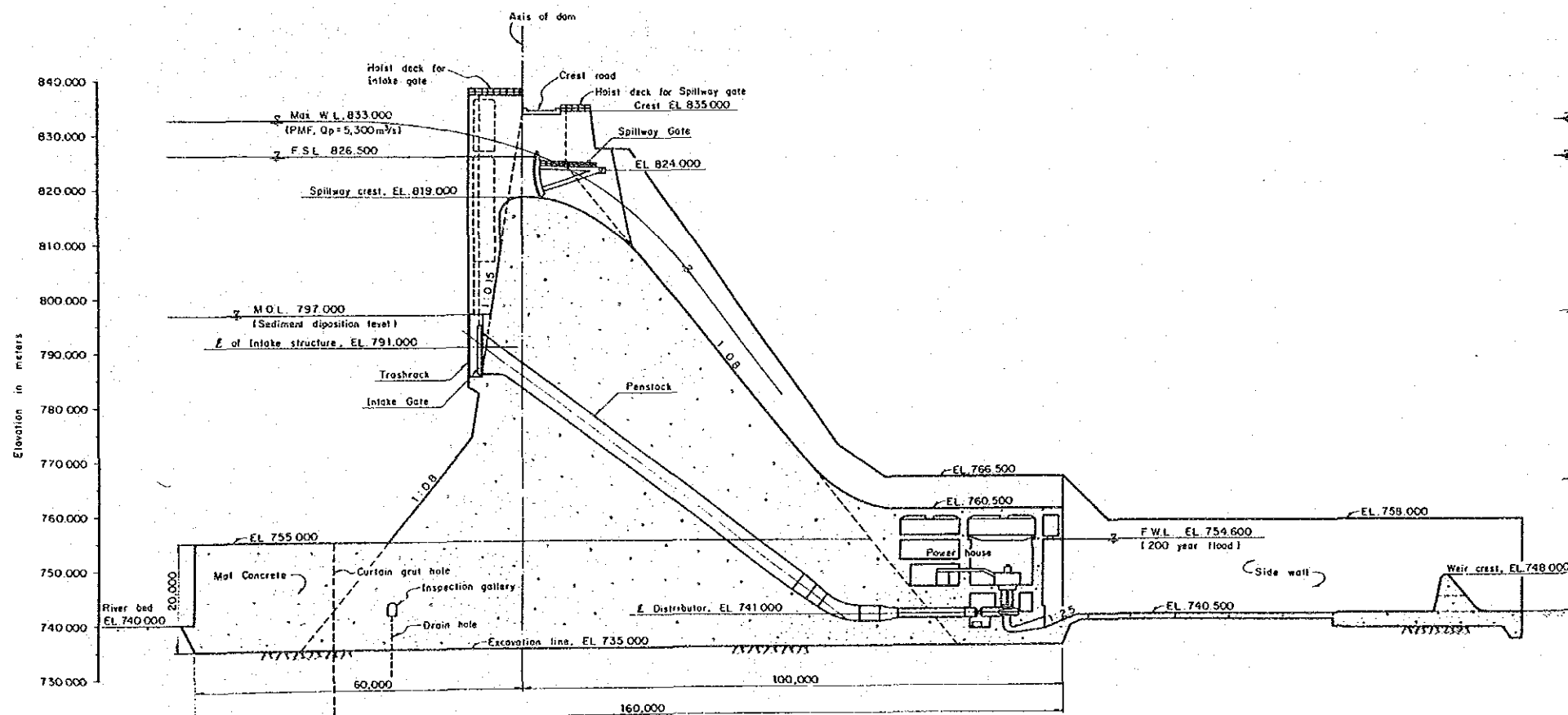

TYPICAL SECTION OF OVERFLOW PORTION
SCALE B

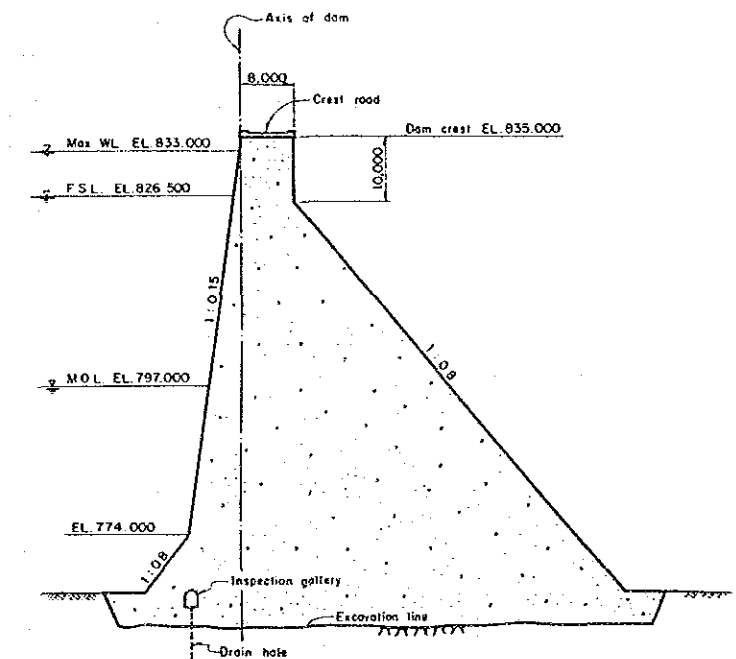

TYPICAL SECTION OF NONOVERFLOW PORTION
SCALE B

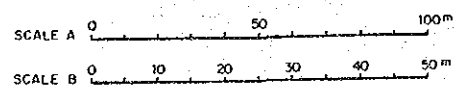

GOVERNMENT OF THE REPUBLIC OF HONDURAS MINISTRY OF NATURAL RESOURCES CHOLUTECA RIVER BASIN AGRICULTURAL DEVELOPMENT PROJECT JAPAN INTERNATIONAL COOPERATION AGENCY	DWG. -03	SAN FERNANDO DAM ELEVATIONS AND SECTIONS
---	-------------	---

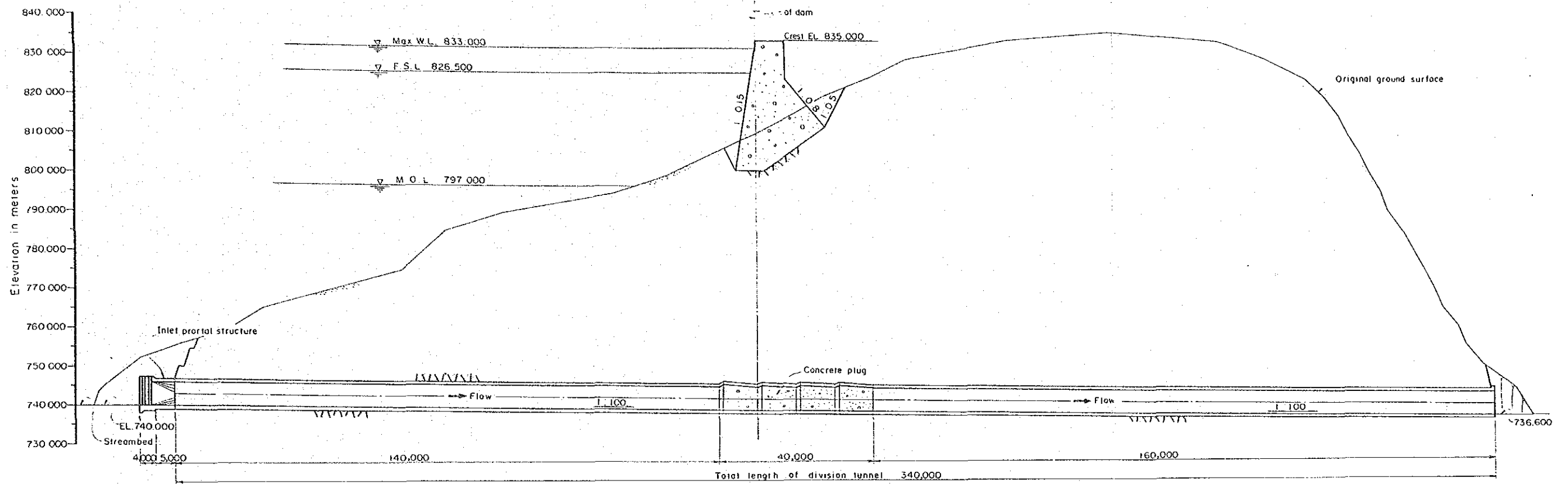

PROFILE ALONG Σ DIVERSION TUNNEL SCALE A

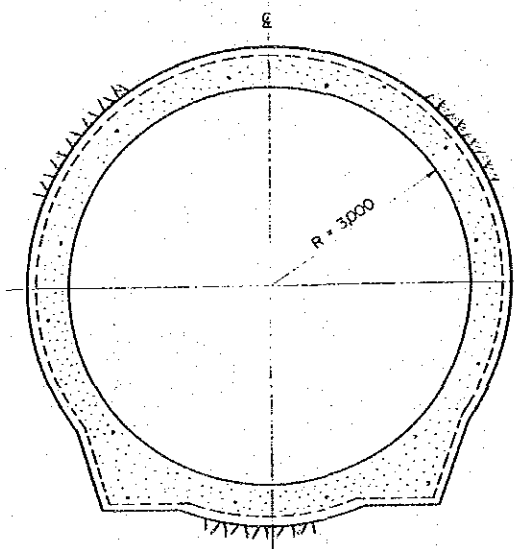

TYPICAL SECTION OF DIVERSION TUNNEL SCALE B

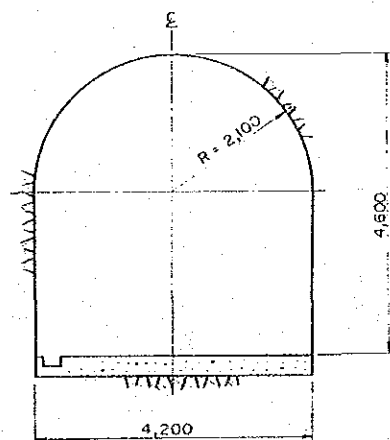

TYPICAL SECTION OF ACCESS ROAD TO POWER HOUSE SCALE B

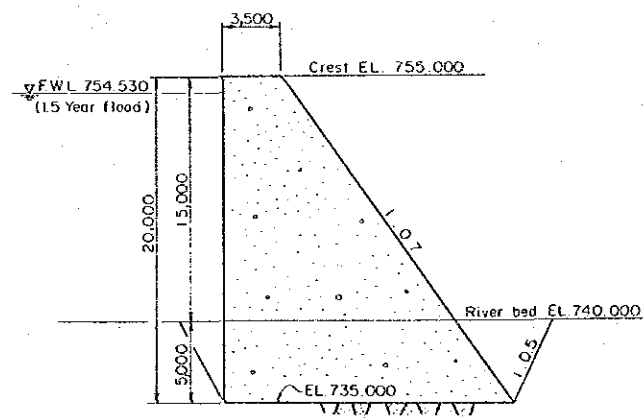

UPSTREAM COFFERDAM

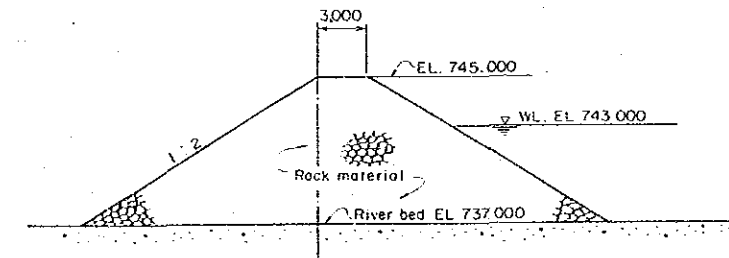

DOWNSTREAM COFFERDAM

TYPICAL SECTION OF COFFERDAMS SCALE C

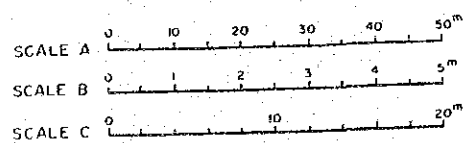

GOVERNMENT OF THE REPUBLIC OF HONDURAS MINISTRY OF NATURAL RESOURCES CHOLUTECA RIVER BASIN AGRICULTURAL DEVELOPMENT PROJECT JAPAN INTERNATIONAL COOPERATION AGENCY	DWG. -04	SAN FERNANDO DAM PROFILE AND SECTIONS
---	-------------	--

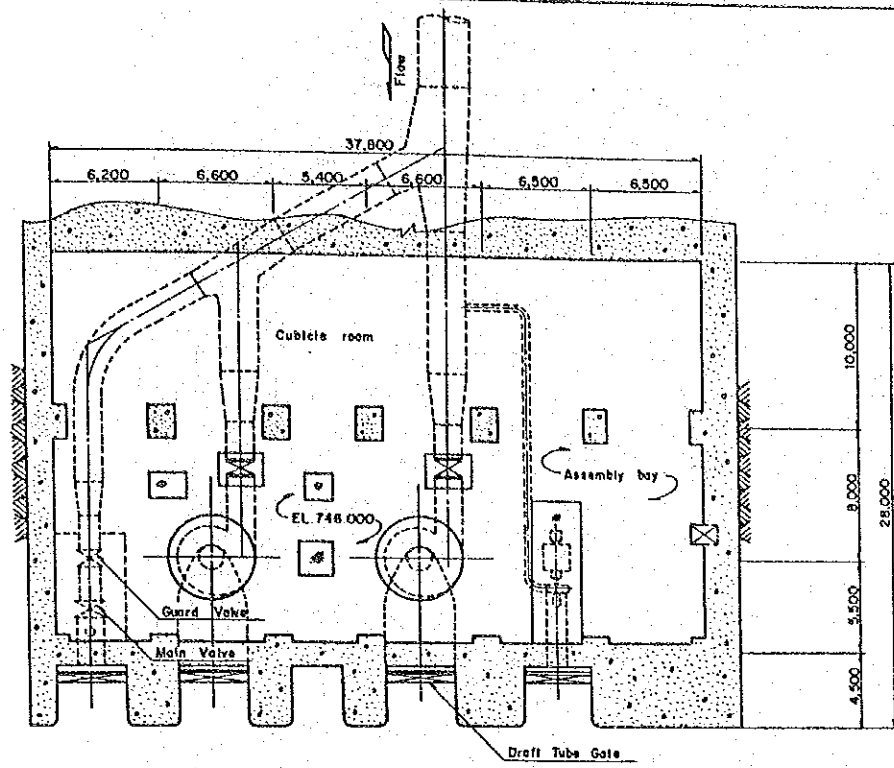

GENERATOR FLOOR PLAN (EL.746.000) SCALE A

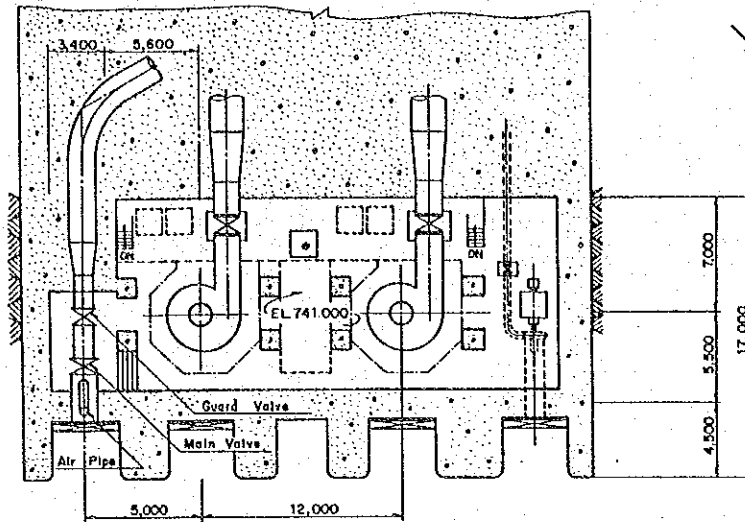

TURBINE FLOOR PLAN (EL.741.000) SCALE A

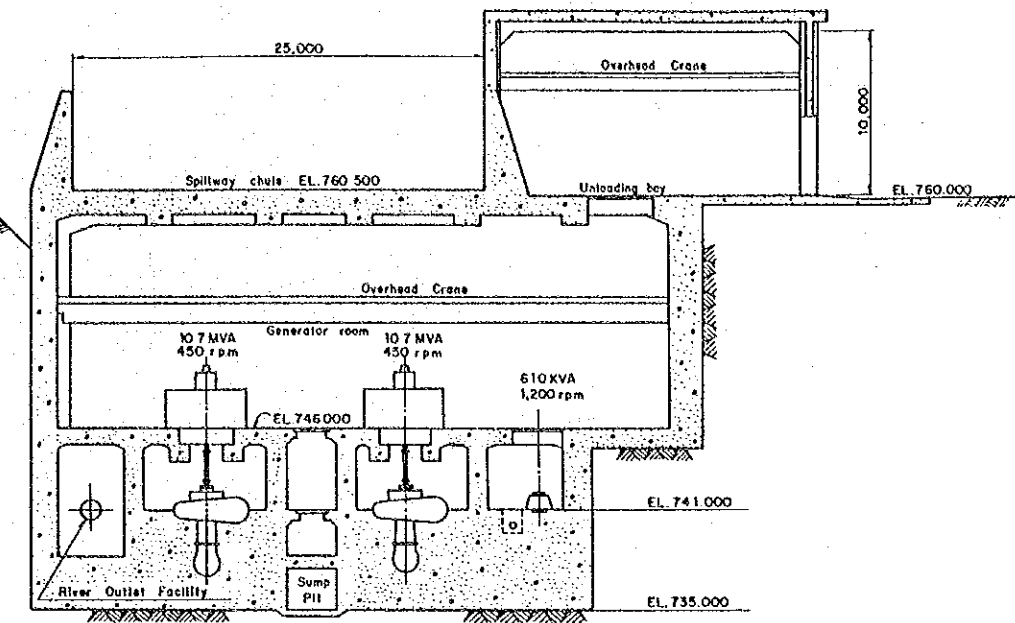

LONGITUDINAL SECTION SCALE A

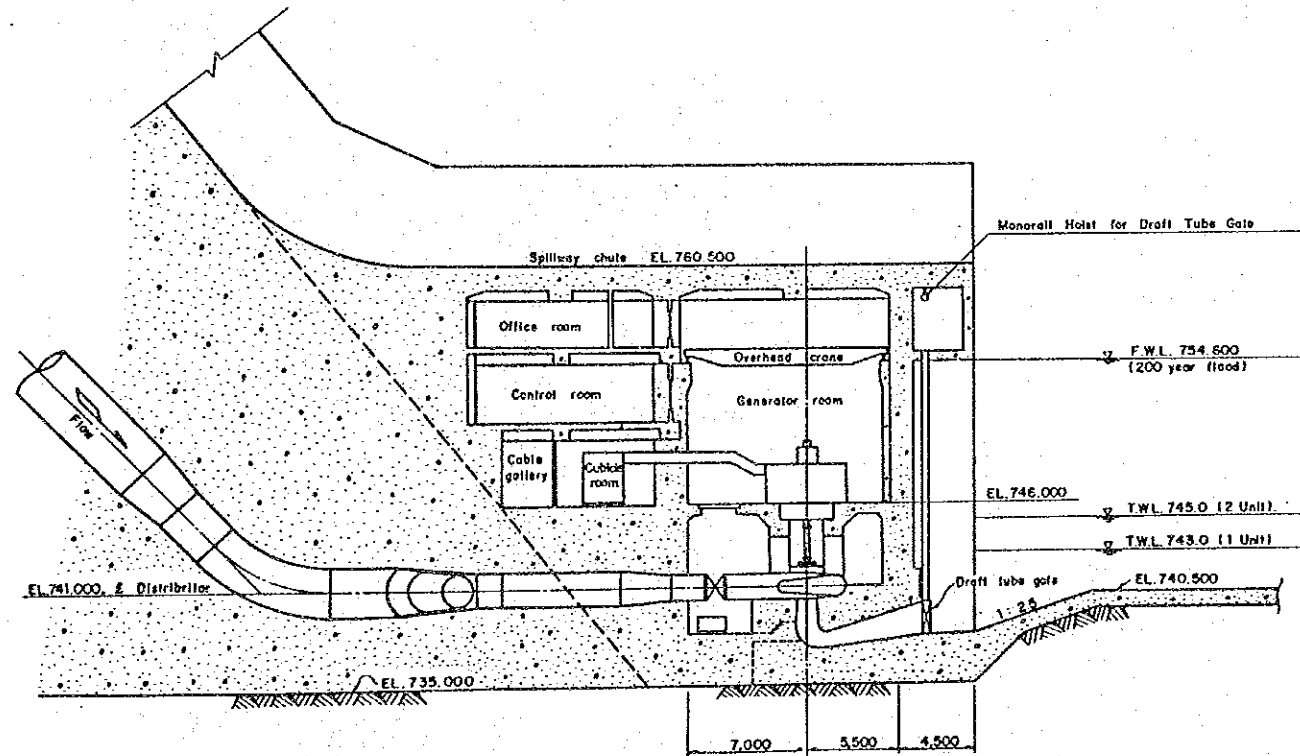

TRANSVERSE SECTION SCALE A

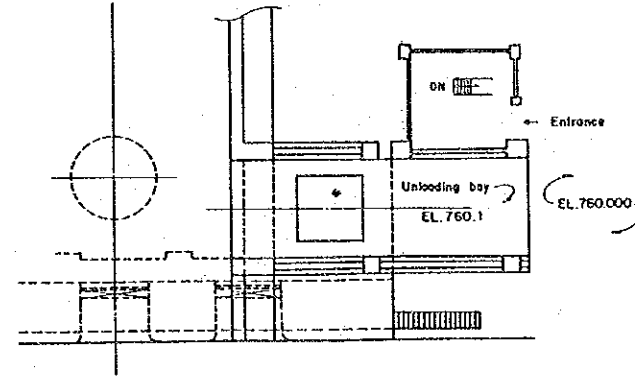

PLAN OF ENTRANCE & UNLOADING BAY SCALE A

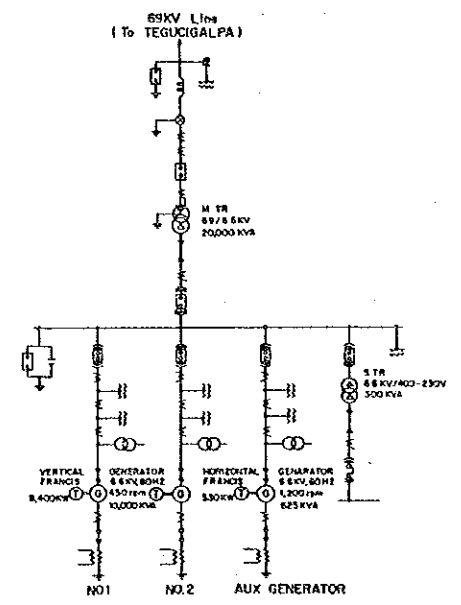

SINGLE LINE DIAGRAM NO SCALE

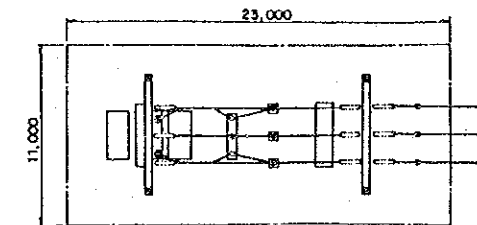
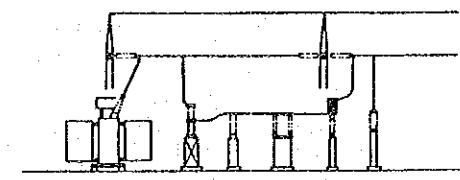

SWITCHYARD SCALE A



GOVERNMENT OF THE REPUBLIC OF HONDURAS MINISTRY OF NATURAL RESOURCES CHOLUTECA RIVER BASIN AGRICULTURAL DEVELOPMENT PROJECT JAPAN INTERNATIONAL COOPERATION AGENCY	DWG	SAN FERNANDO POWERHOUSE AND SINGLE LINE DIAGRAM
	-05	

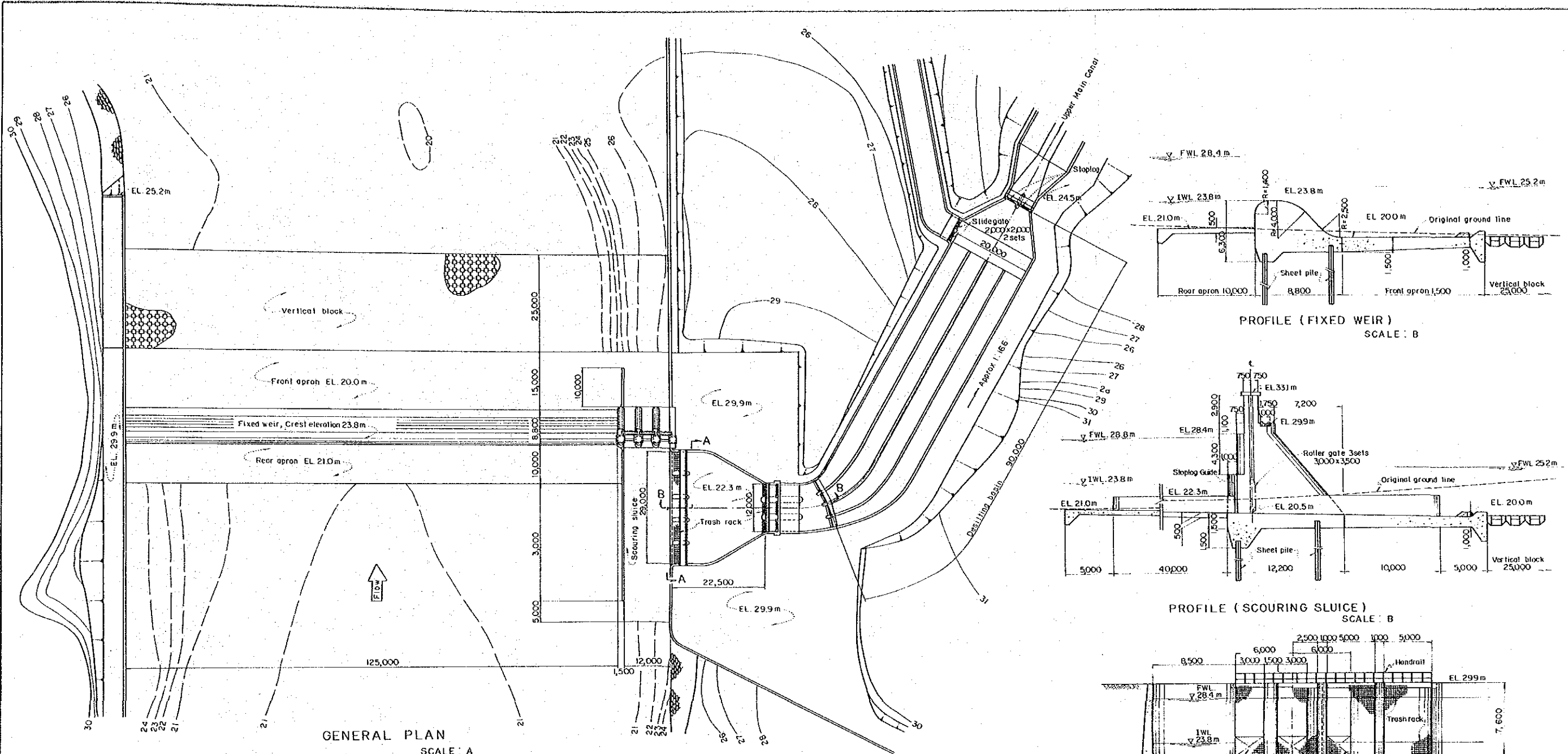

GENERAL PLAN
SCALE: A

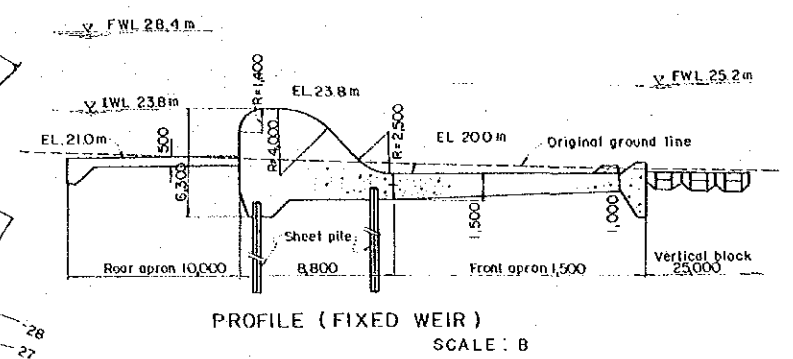

PROFILE (FIXED WEIR)
SCALE: B

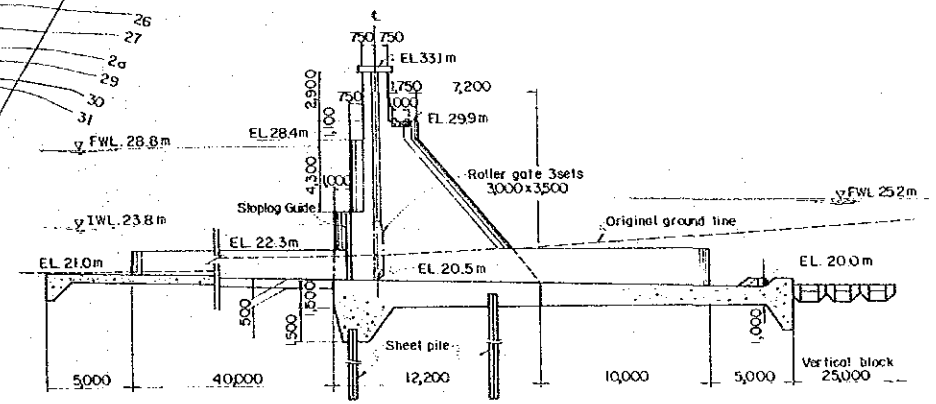

PROFILE (SCOURING SLUICE)
SCALE: B

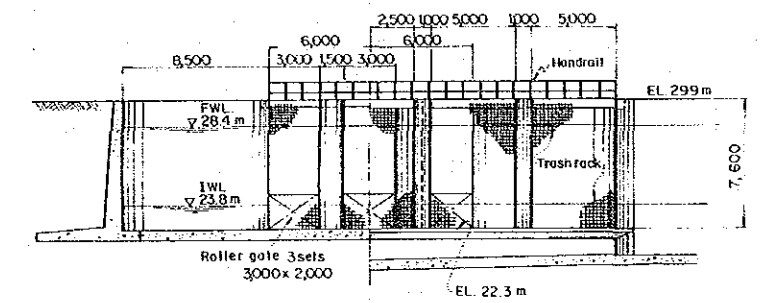

SECTION A-A
SCALE: B

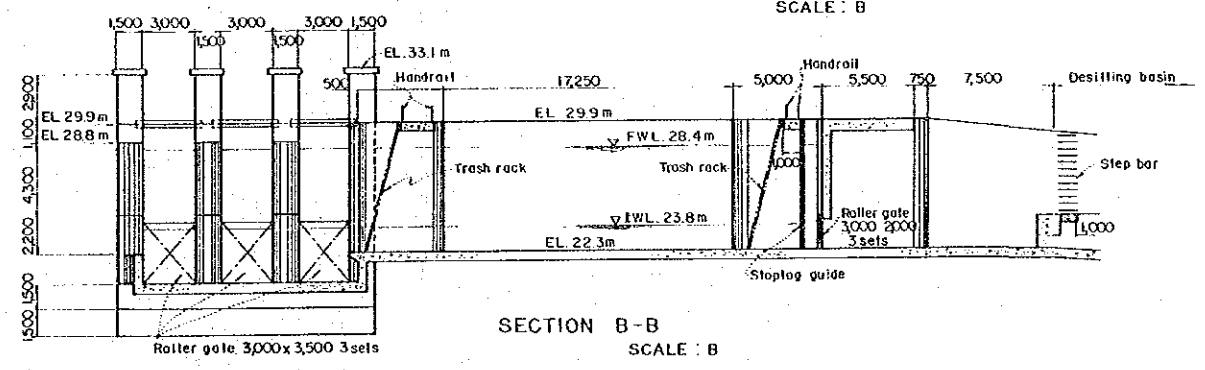

SECTION B-B
SCALE: B

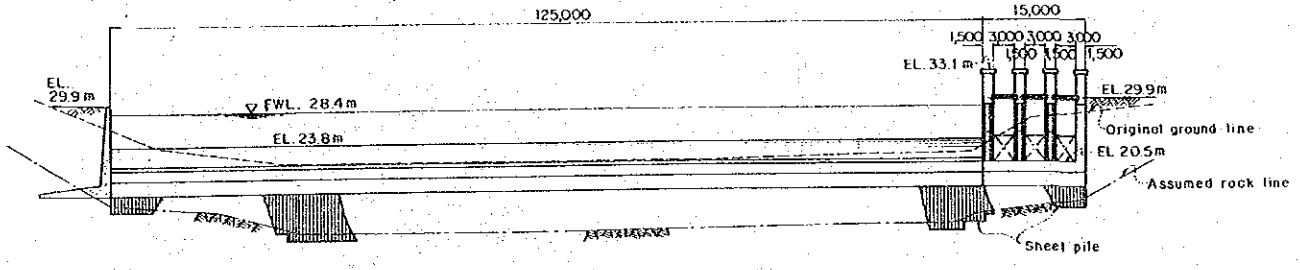

FRONT VIEW
SCALE: A

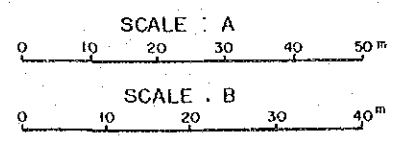

GOVERNMENT OF THE REPUBLIC OF HONDURAS MINISTRY OF NATURAL RESOURCES CHOLUTECA RIVER BASIN AGRICULTURAL DEVELOPMENT PROJECT JAPAN INTERNATIONAL COOPERATION AGENCY	DWG.	EL PAPALON INTAKE WEIR
	-06	

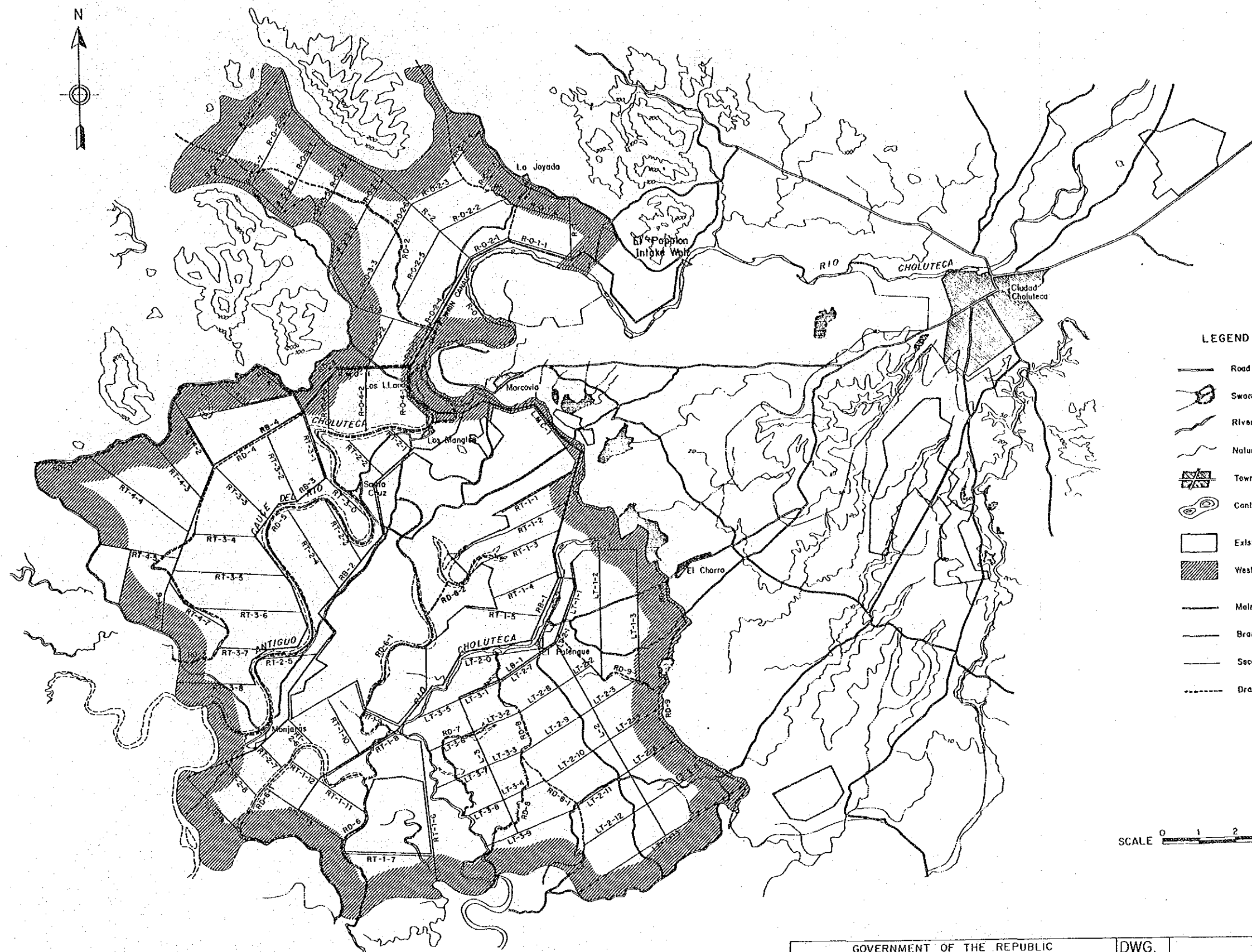

LEGEND

- Road
- Swamp
- River
- Natural Drain
- Town
- Center Line
- Existing Irrigation Area
- Western Plain Border Line
- Main Canal
- Branch Canal
- Secondary & Tertiary Canal
- Drain Canal



GOVERNMENT OF THE REPUBLIC OF HONDURAS MINISTRY OF NATURAL RESOURCES CHOLUTECA RIVER BASIN AGRICULTURAL DEVELOPMENT PROJECT JAPAN INTERNATIONAL COOPERATION AGENCY	DWG. -07	LAYOUT IN WESTERN PLAIN AREA
---	-------------	------------------------------

TYPICAL SECTION OF IRRIGATION CANAL

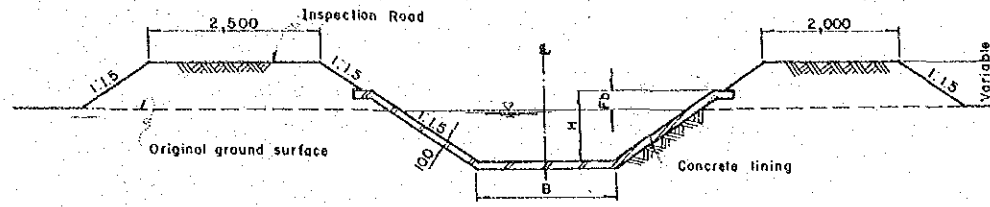

MAIN CANAL & BRANCH CANAL

TYPICAL SECTION OF DRAINAGE CANAL

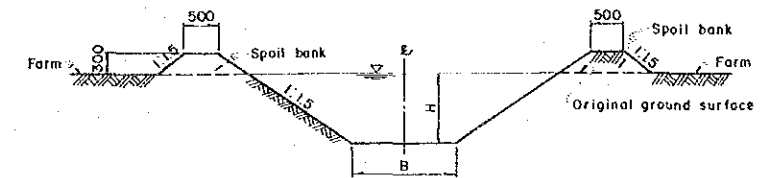

MAIN DRAIN & SECONDARY DRAIN

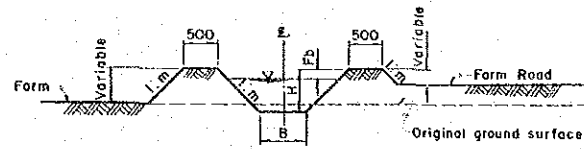

SECONDARY & TERTIARY CANAL

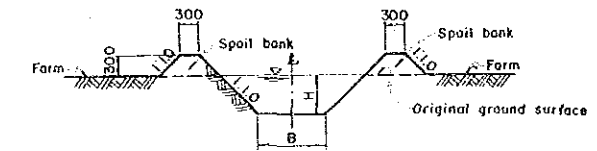

COLECTOR & FIELD DRAIN

FARM ROAD

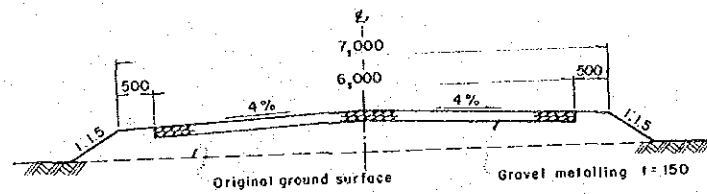

MAIN FARM ROAD & LINKED ROAD

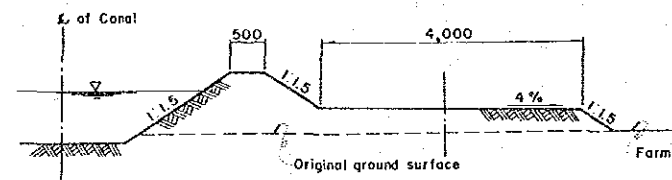

SECONDARY FARM ROAD

SCALE _____
 SCALE _____
 SCALE _____

GOVERNMENT OF THE REPUBLIC OF HONDURAS MINISTRY OF NATURAL RESOURCES CHOLUTECA RIVER BASIN AGRICULTURAL DEVELOPMENT PROJECT JAPAN INTERNATIONAL COOPERATION AGENCY	DWG. -08	TYPICAL SECTION OF IRRIGATION DRAINAGE CANAL & FARM ROAD
---	-------------	---

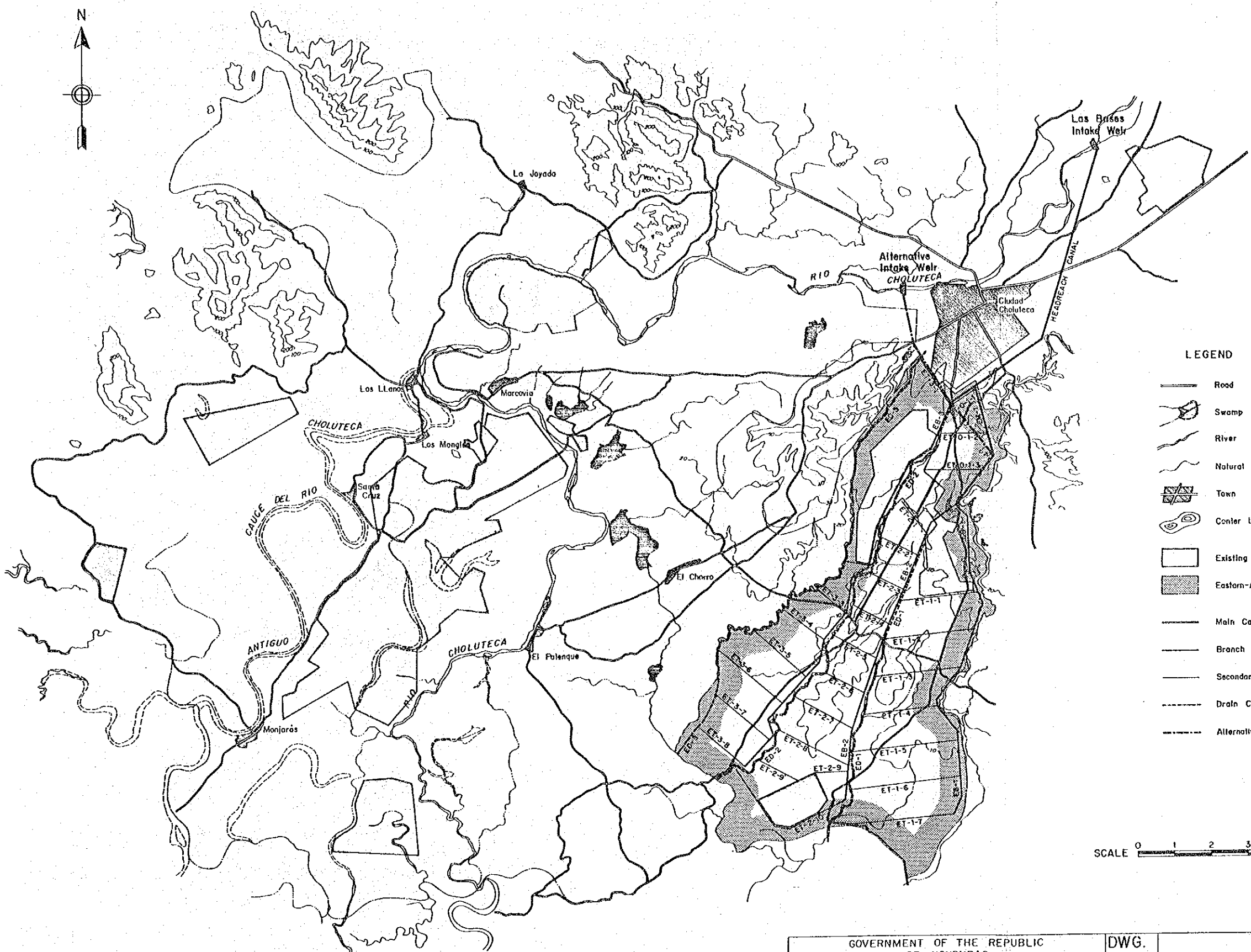

LEGEND

- Road
- Swamp
- River
- Natural Drain
- Town
- Contour Line
- Existing Irrigation Area
- Eastern-A Plain Border Line
- Main Canal
- Branch Canal
- Secondary & Tertiary Canal
- Drain Canal
- Alternative Canal Route

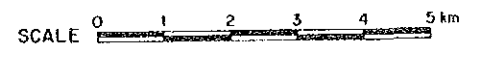

GOVERNMENT OF THE REPUBLIC OF HONDURAS MINISTRY OF NATURAL RESOURCES CHOLUTECA RIVER BASIN AGRICULTURAL DEVELOPMENT PROJECT JAPAN INTERNATIONAL COOPERATION AGENCY	DWG.	LAYOUT IN EASTERN PLAIN-A AREA
	-09	

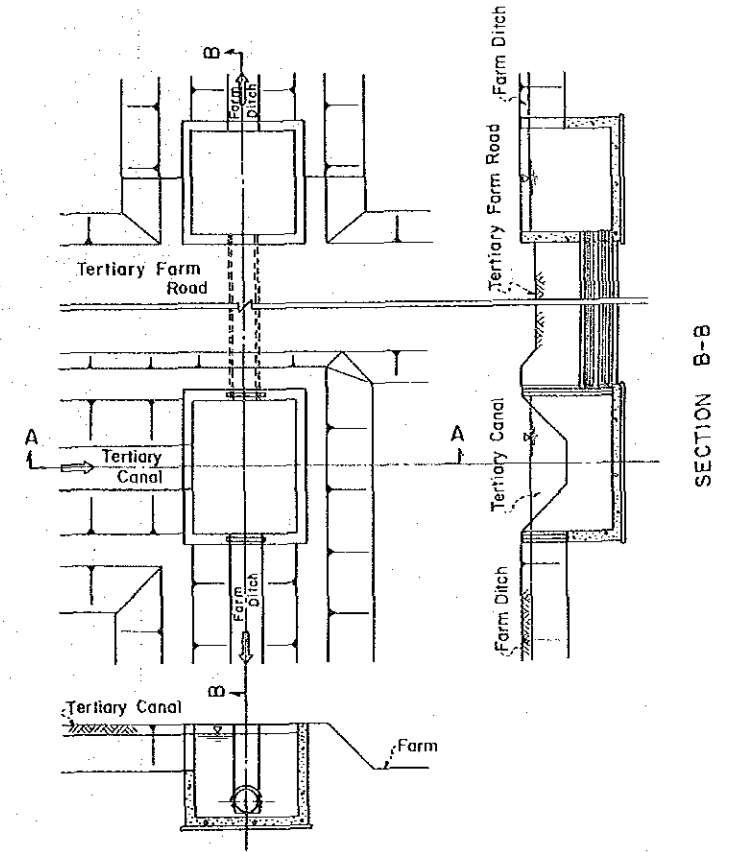
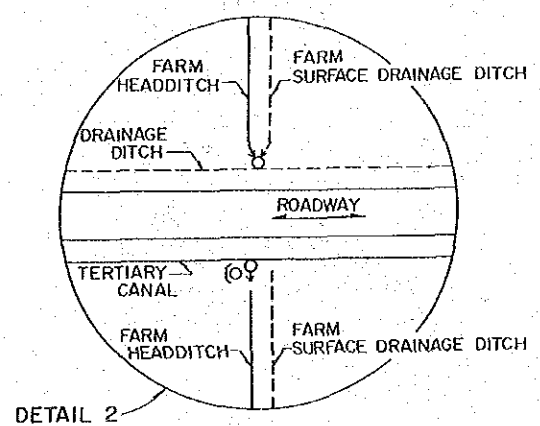
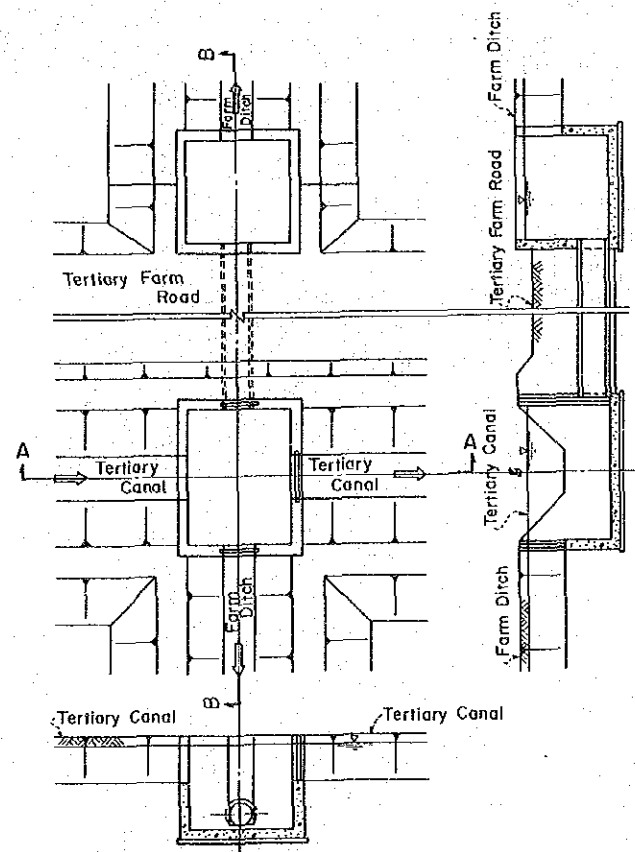
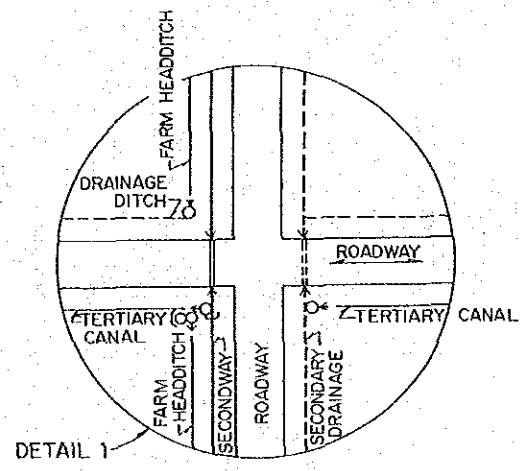
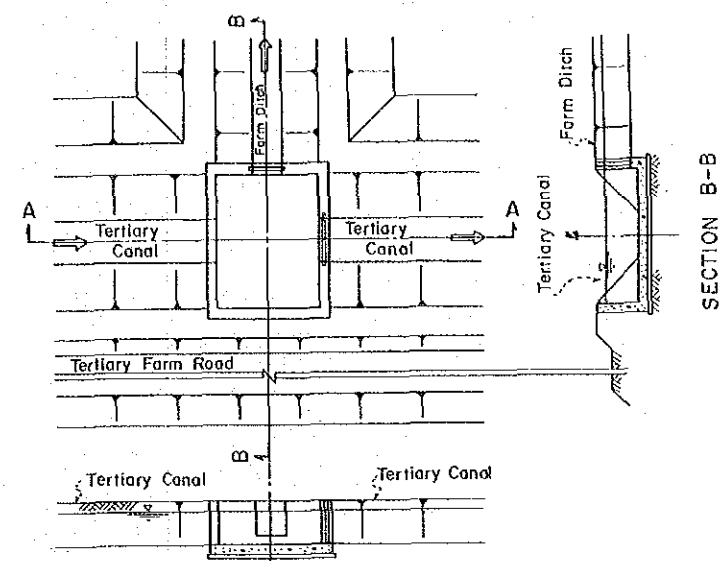
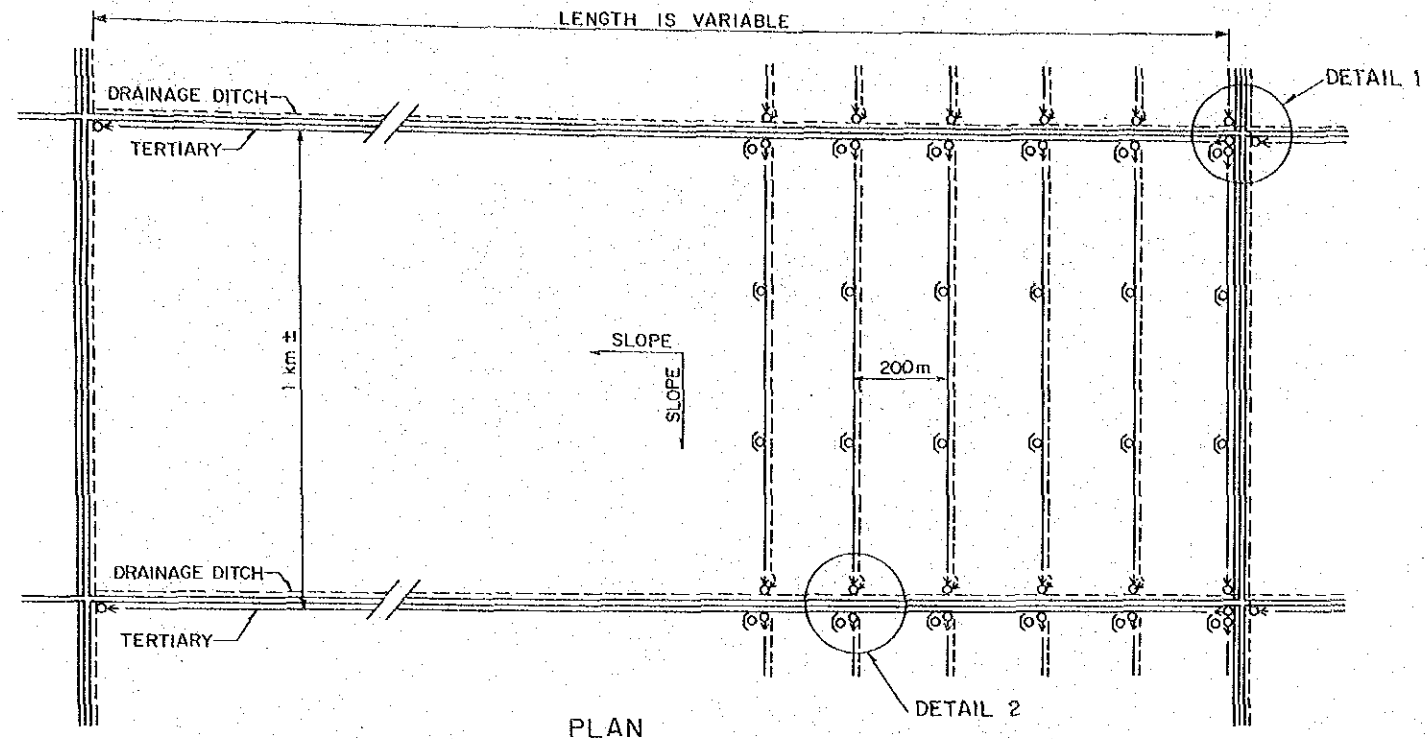

GOVERNMENT OF THE REPUBLIC OF HONDURAS MINISTRY OF NATURAL RESOURCES CHOLUTECA RIVER BASIN AGRICULTURAL DEVELOPMENT PROJECT JAPAN INTERNATIONAL COOPERATION AGENCY	DWG. -10	TYPICAL FARM LAYOUT AND DIVISION BOX
---	-------------	---

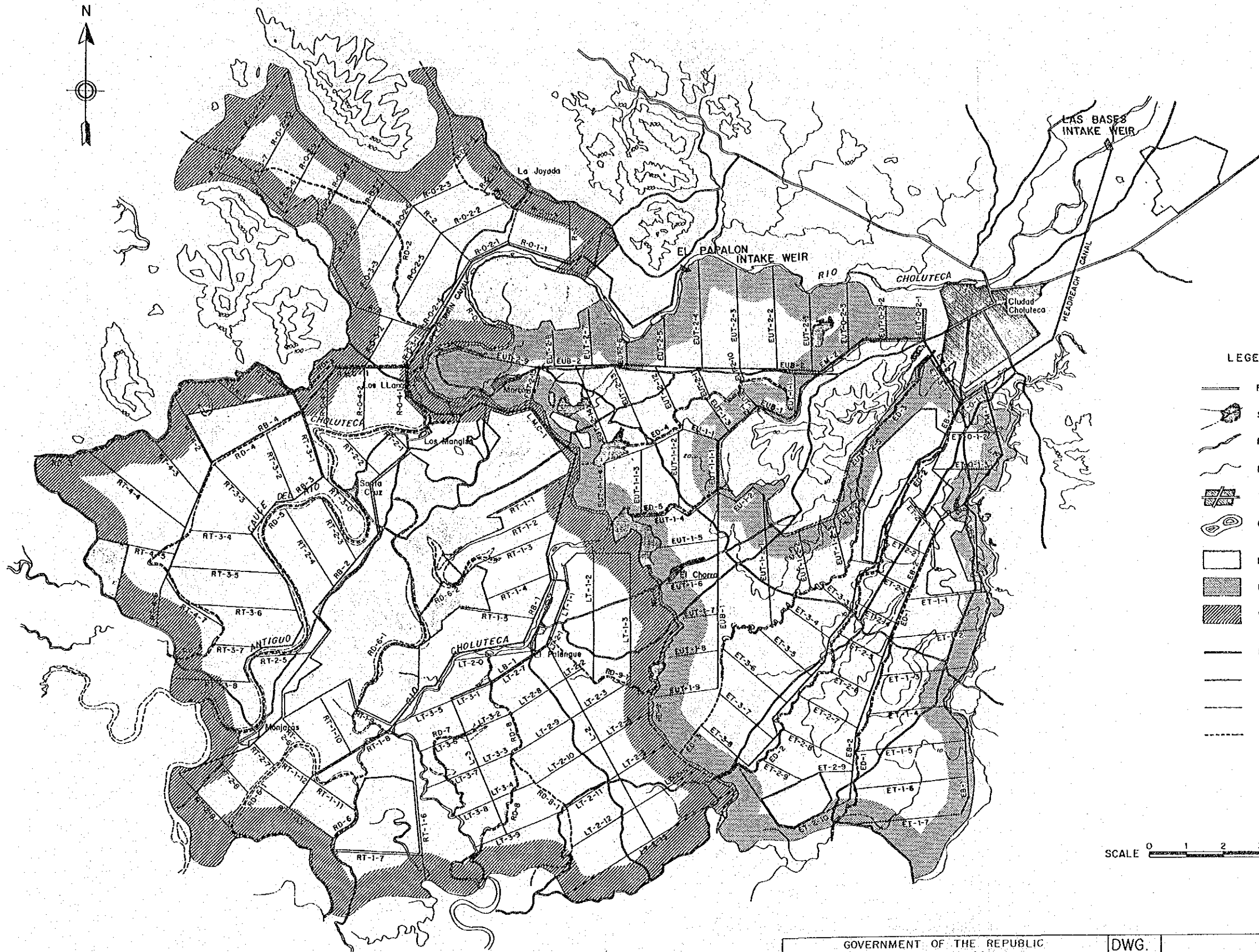

LEGEND

- Road
- Swamp
- River
- Natural Drain
- Town
- Center Line
- Existing Irrigation Area
- Eastern Plain Border Line
- Western Plain Border Line
- Main Canal
- Branch Canal
- Secondary & Tertiary Canal
- Drain Canal

SCALE 0 1 2 3 4 5 km

GOVERNMENT OF THE REPUBLIC OF HONDURAS MINISTRY OF NATURAL RESOURCES	DWG. - 11	LAYOUT IN WHOLE CHOLUTECA PLAIN
CHOLUTECA RIVER BASIN AGRICULTURAL DEVELOPMENT PROJECT JAPAN INTERNATIONAL COOPERATION AGENCY		



