

THE UNITED REPUBLIC OF TANZANIA

*FEASIBILITY STUDY
ON
THE MKOMAZI VALLEY AREA
IRRIGATION DEVELOPMENT PROJECT.*

*VOLUME III
DRAWINGS*

JANUARY 1984

JAPAN INTERNATIONAL COOPERATION AGENCY

JICA LIBRARY



1029608151

THE UNITED REPUBLIC OF TANZANIA

*FEASIBILITY STUDY
ON
THE MKOMAZI VALLEY AREA
IRRIGATION DEVELOPMENT PROJECT*

*VOLUME III
DRAWINGS*

JANUARY 1984

JAPAN INTERNATIONAL COOPERATION AGENCY





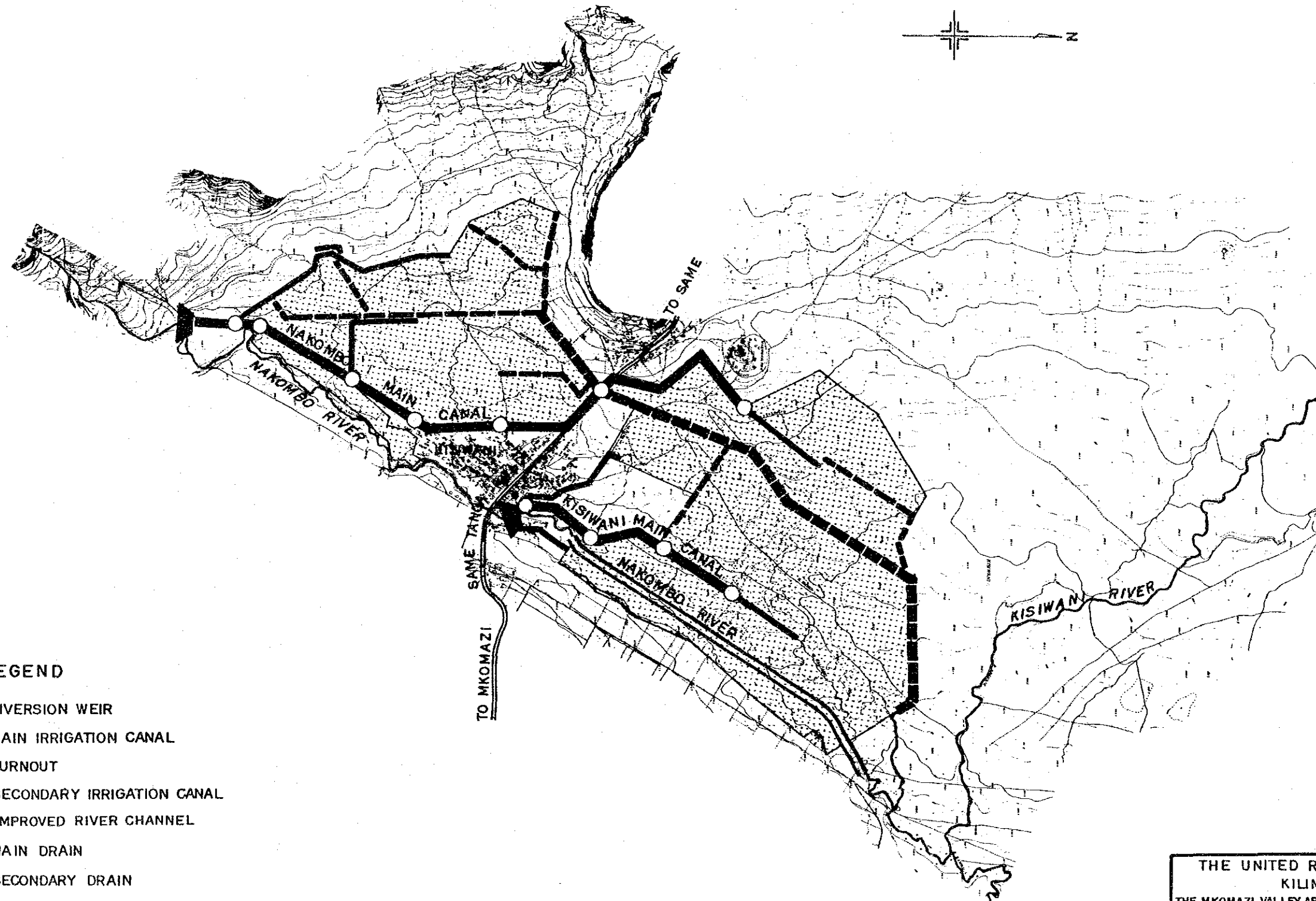

LIST OF DRAWINGS

<u>Plate No.</u>	<u>DWG. No.</u>	<u>Title of Drawing</u>
1	1 - 1	GENERAL LAYOUT - KISIWANI SCHEME -
2	1 - 2	GENERAL LAYOUT - GONJA SCHEME -
3	1 - 3	GENERAL LAYOUT - NDUNGU SCHEME -
4	1 - 4	GENERAL LAYOUT - KIHURIO SCHEME -
5	1 - 5	GENERAL LAYOUT - IGOMA SCHEME -
6	2 - 1	KALIMAWE DAM
7	2 - 2	IGOMA DAM
8	3 - 1	NAKOMBO DIVERSION WEIR
9	3 - 2	HINGILILI DIVERSION WEIR
10	3 - 3	YONGOMA DIVERSION WEIR
11	3 - 4	SASENI DIVERSION WEIR
12	4 - 1	PROFILE OF NAKOMBO MAIN CANAL (1/2) - KISIWANI SCHEME -
13	4 - 2	PROFILE OF NAKOMBO MAIN CANAL (2/2) - KISIWANI SCHEME -
14	4 - 3	PROFILE OF KISIWANI MAIN CANAL - KISIWANI SCHEME -
15	4 - 4	PROFILE OF HINGILILI MAIN CANAL (1/2) - GONJA SCHEME -
16	4 - 5	PROFILE OF HINGILILI MAIN CANAL (2/2) - GONJA SCHEME -
17	4 - 6	PROFILE OF YONGOMA MAIN CANAL & YONGOMA RIGHT MAIN CANAL - NDUNGU SCHEME -
18	4 - 7	PROFILE OF YONGOMA LEFT MAIN CANAL - NDUNGU SCHEME -
19	4 - 8	PROFILE OF SASENI RIGHT MAIN CANAL (1/2) - KIHURIO SCHEME -
20	4 - 9	PROFILE OF SASENI RIGHT MAIN CANAL (2/2) - KIHURIO SCHEME -
21	4 - 10	PROFILE OF SASENI LEFT MAIN CANAL - KIHURIO SCHEME -
22	4 - 11	PROFILE OF KALIMAWE LEFT MAIN CANAL - KIHURIO SCHEME -
23	4 - 12	PROFILE OF KALIMAWE RIGHT MAIN CANAL - KIHURIO SCHEME -
24	4 - 13	PROFILE OF IGOMA RIGHT MAIN CANAL - IGOMA SCHEME -
25	4 - 14	PROFILE OF IGOMA LEFT MAIN CANAL - IGOMA SCHEME -
26	5 - 1	PROFILE OF RIVERS
27	5 - 2	PROFILE OF MKOMAZI RIVER (1/2) - KIHURIO SCHEME -
28	5 - 3	PROFILE OF MKOMAZI RIVER (2/2) - KIHURIO SCHEME -
29	5 - 4	PROFILE OF SASENI FLOODWAY - KIHURIO SCHEME -
30	5 - 5	PROFILE OF YONGOMA FLOODWAY - NDUNGU SCHEME -
31	5 - 6	PROFILE OF HINGILILI FLOODWAY - GONJA SCHEME -
32	5 - 7	PROFILE OF KAMBAGA RIVER (1/2) - IGOMA SCHEME -
33	5 - 8	PROFILE OF KAMBAGA RIVER (2/2) - IGOMA SCHEME -
34	5 - 9	PROFILE OF NAKOMBO RIVER - KISIWANI SCHEME -
35	6 - 1	TURNOUT & CHECK
36	6 - 2	CULVERT & SIPHON
37	6 - 3	DROP & CHUTE
38	6 - 4	SPILLWAY & WASTEWAY
39	6 - 5	CROSSDRAIN & DRAINAGE DROP
40	6 - 6	TYPICAL CROSS SECTION OF IRRIGATION CANAL, FARM ROAD, FLOODWAY & DRAINAGE CANAL

国際協力事業団	
受入 月日 '84. 4. 25	416
登録No. 10246	83.3
	AET









LEGEND

-  DIVERSION WEIR
-  MAIN IRRIGATION CANAL
-  TURNOUT
-  SECONDARY IRRIGATION CANAL
-  IMPROVED RIVER CHANNEL
-  MAIN DRAIN
-  SECONDARY DRAIN



THE UNITED REPUBLIC OF TANZANIA KILIMANJARO REGION THE MKOMAZI VALLEY AREA IRRIGATION DEVELOPMENT PROJECT	
TITLE OF DRAWING GENERAL LAYOUT - KISIWANI SCHEME -	
JAPAN INTERNATIONAL COOPERATION AGENCY TOKYO	DWG. NO. 1-1

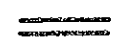



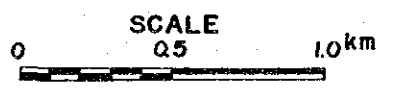
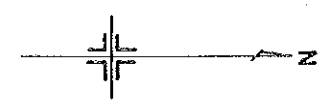
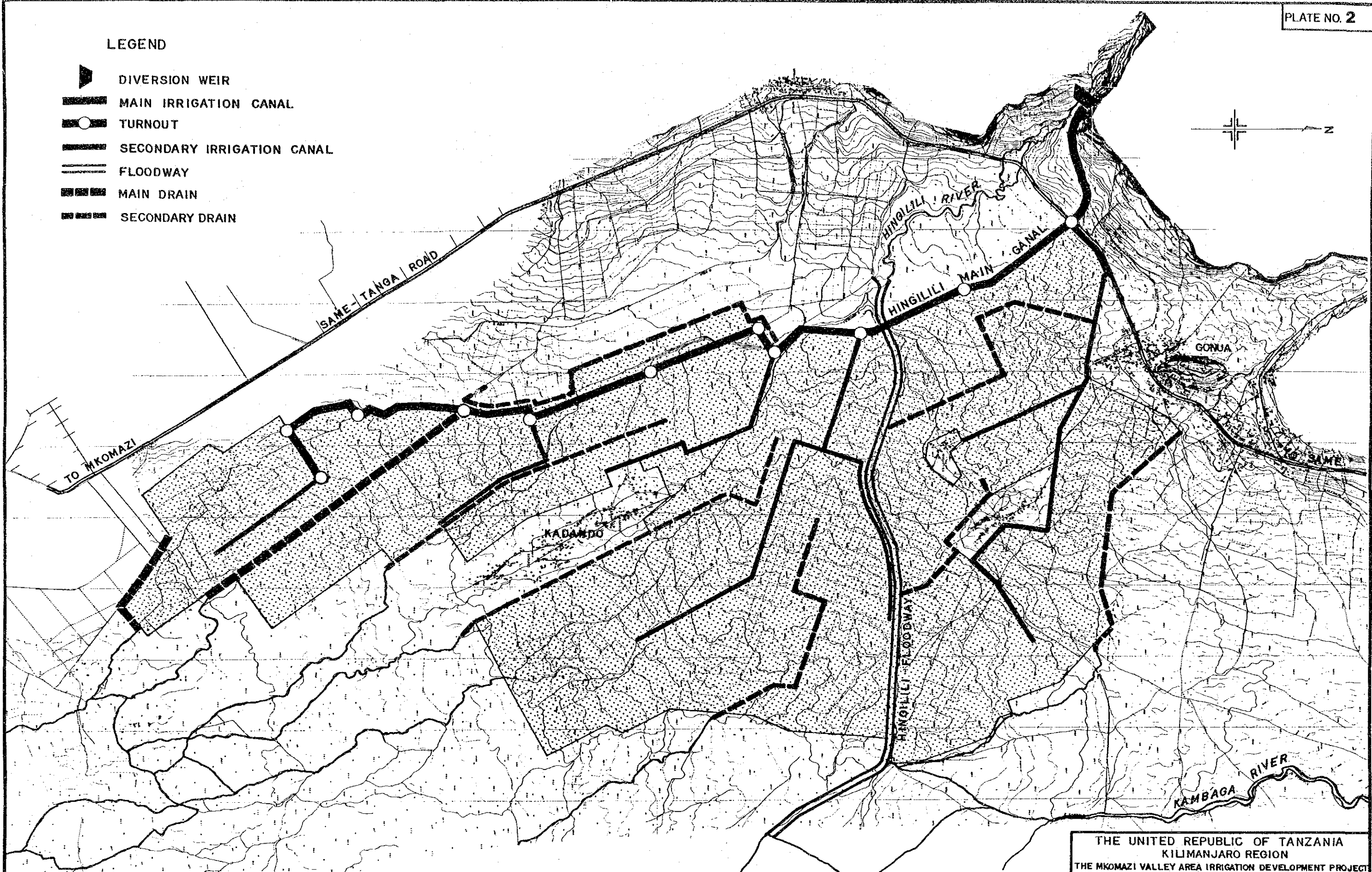

LEGEND

-  DIVERSION WEIR
-  MAIN IRRIGATION CANAL
-  TURNOUT
-  SECONDARY IRRIGATION CANAL
-  FLOODWAY
-  MAIN DRAIN
-  SECONDARY DRAIN



THE UNITED REPUBLIC OF TANZANIA KILIMANJARO REGION	
THE MKOMAZI VALLEY AREA IRRIGATION DEVELOPMENT PROJECT	
TITLE OF DRAWING	
GENERAL LAYOUT - GONJA SCHEME -	
JAPAN INTERNATIONAL COOPERATION AGENCY	DWG. NO.
TOKYO	1-2

LEGEND

-  DIVERSION WEIR
-  MAIN IRRIGATION CANAL
-  TURNOUT
-  SECONDARY IRRIGATION CANAL
-  FLOODWAY
-  SECONDARY DRAIN
-  FLOOD DIKE

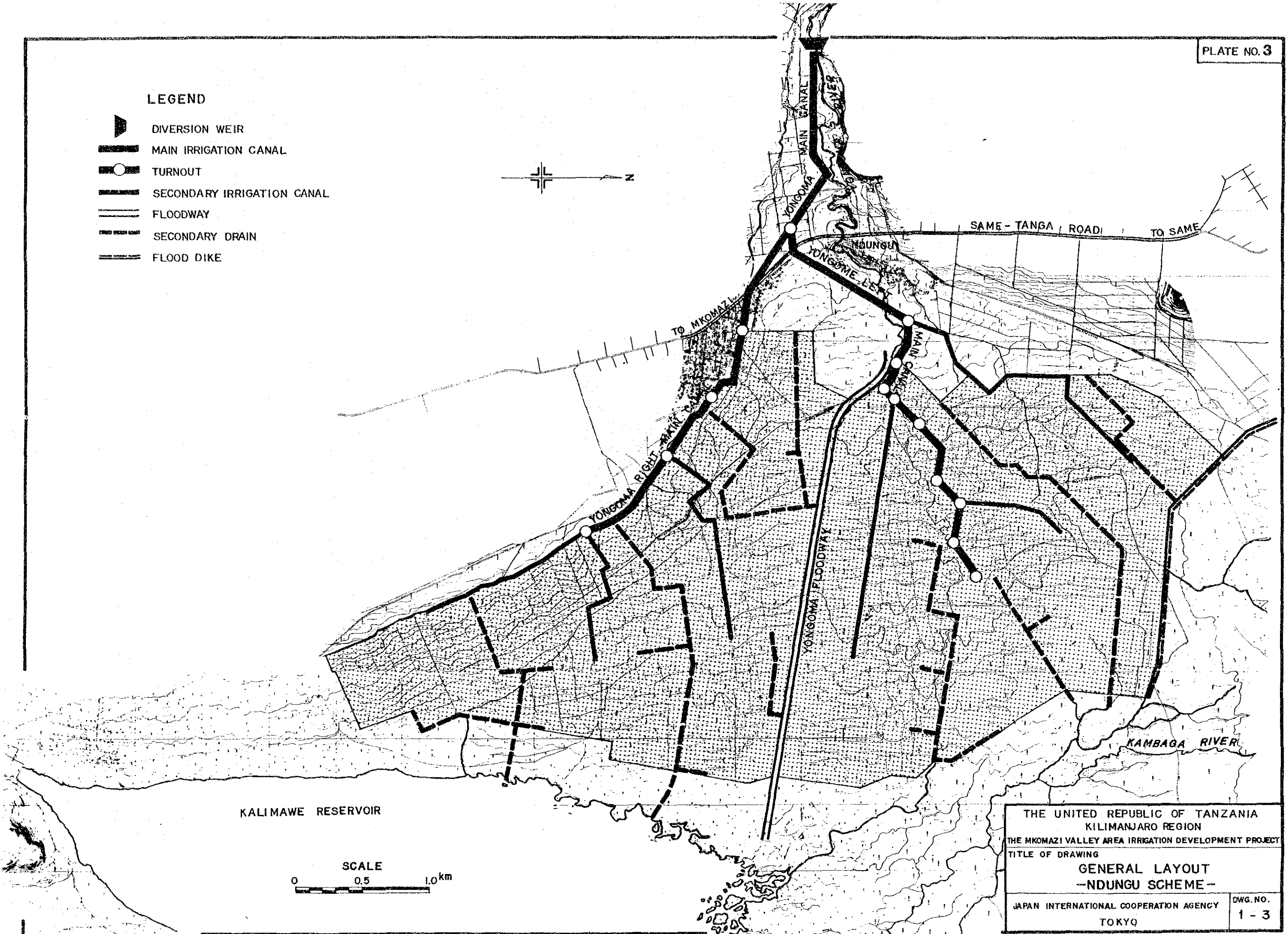
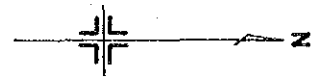



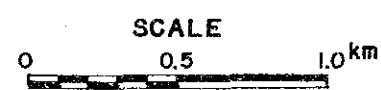





KALIMAWE RESERVOIR



THE UNITED REPUBLIC OF TANZANIA KILIMANJARO REGION THE MKOMAZI VALLEY AREA IRRIGATION DEVELOPMENT PROJECT	
TITLE OF DRAWING GENERAL LAYOUT -NDUNGU SCHEME-	
JAPAN INTERNATIONAL COOPERATION AGENCY TOKYO	DWG. NO. 1 - 3

LEGEND



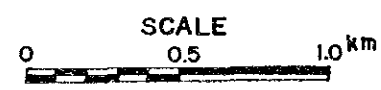
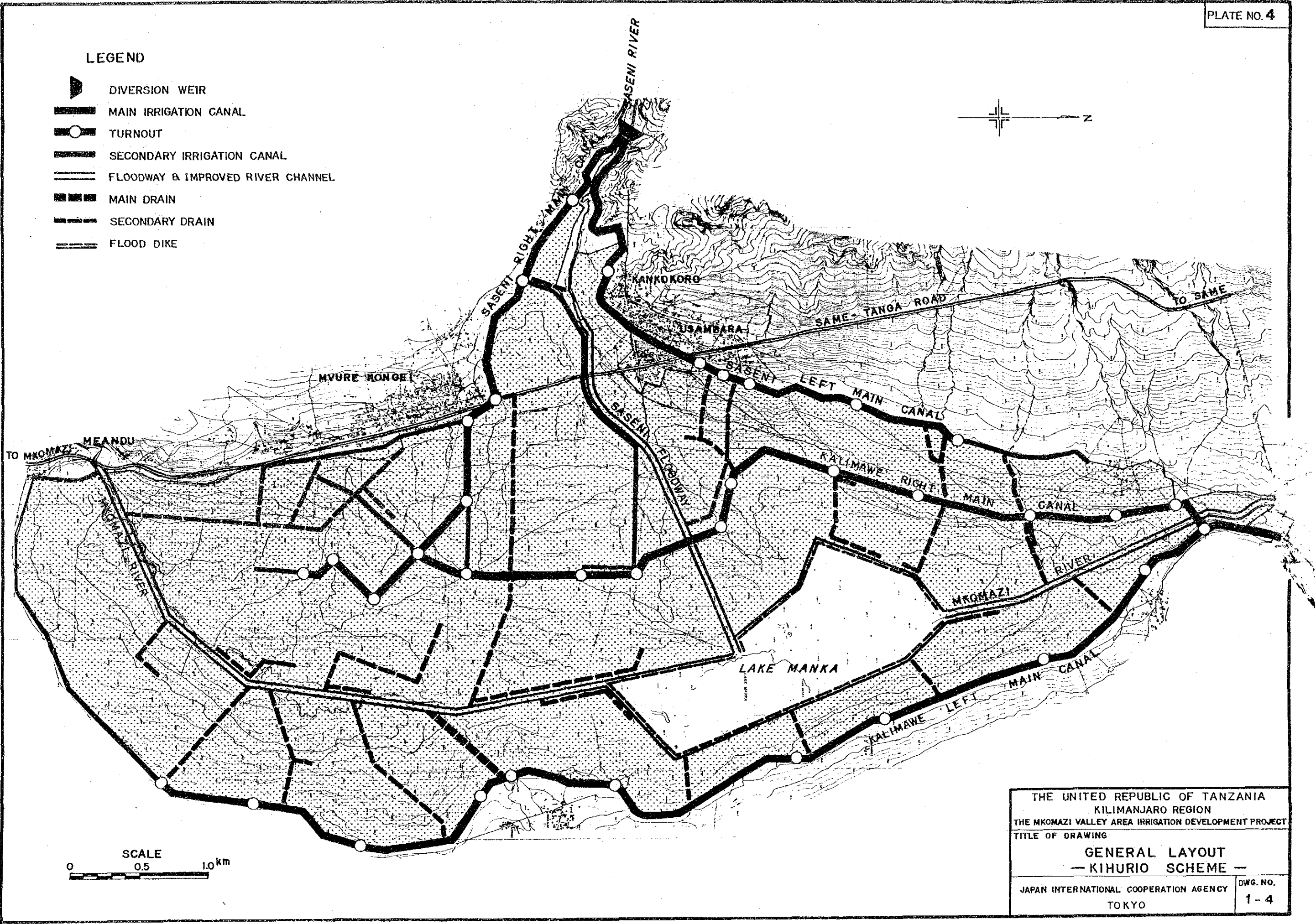

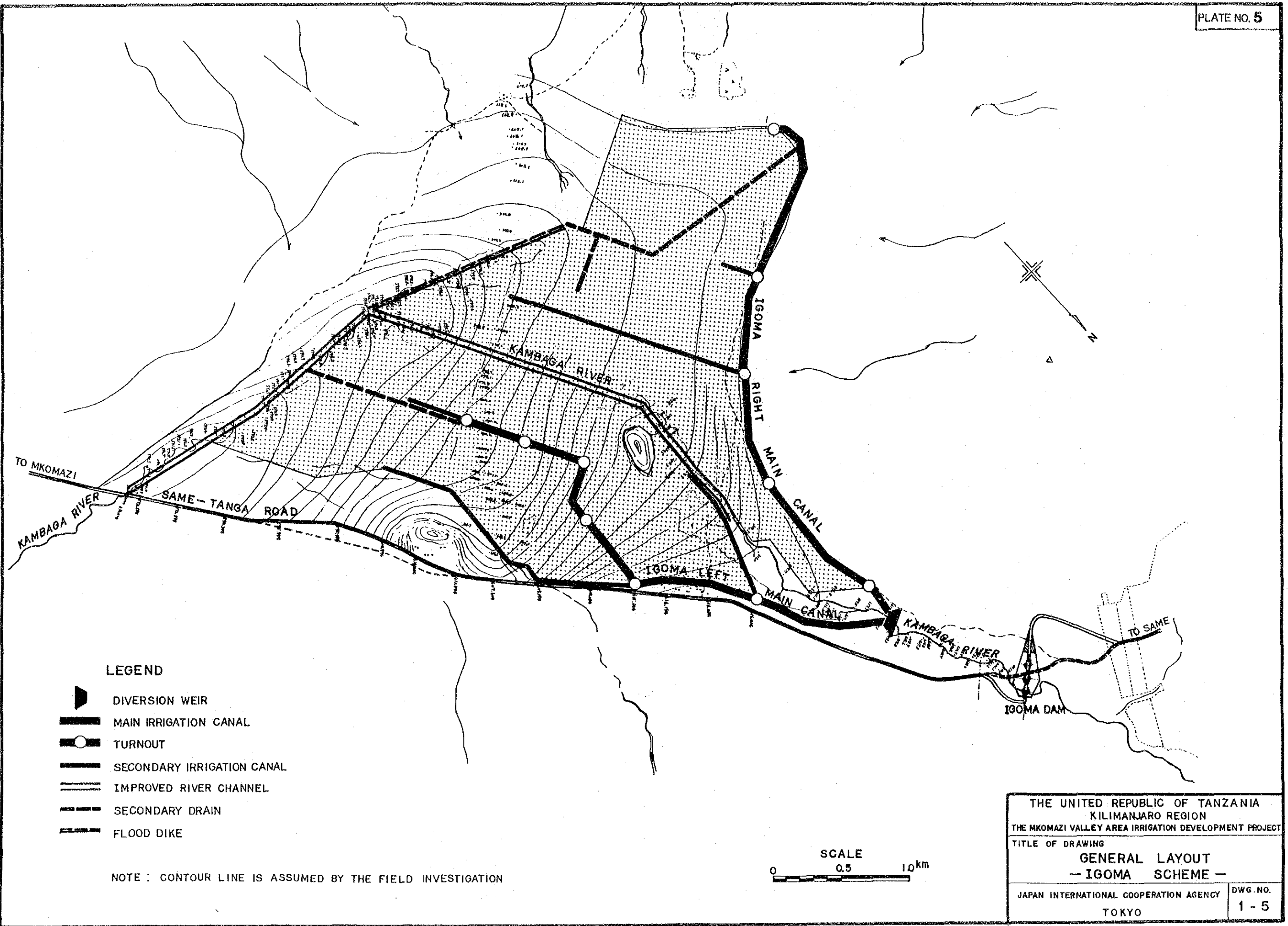

-  DIVERSION WEIR
-  MAIN IRRIGATION CANAL
-  TURNOUT
-  SECONDARY IRRIGATION CANAL
-  FLOODWAY & IMPROVED RIVER CHANNEL
-  MAIN DRAIN
-  SECONDARY DRAIN
-  FLOOD DIKE



THE UNITED REPUBLIC OF TANZANIA	
KILIMANJARO REGION	
THE MKOMAZI VALLEY AREA IRRIGATION DEVELOPMENT PROJECT	
TITLE OF DRAWING	
GENERAL LAYOUT	
— KIHURIO SCHEME —	
JAPAN INTERNATIONAL COOPERATION AGENCY TOKYO	DWG. NO. 1-4



LEGEND

-  DIVERSION WEIR
-  MAIN IRRIGATION CANAL
-  TURNOUT
-  SECONDARY IRRIGATION CANAL
-  IMPROVED RIVER CHANNEL
-  SECONDARY DRAIN
-  FLOOD DIKE

NOTE : CONTOUR LINE IS ASSUMED BY THE FIELD INVESTIGATION



THE UNITED REPUBLIC OF TANZANIA KILIMANJARO REGION THE MKOMAZI VALLEY AREA IRRIGATION DEVELOPMENT PROJECT	
TITLE OF DRAWING GENERAL LAYOUT - IGOMA SCHEME -	
JAPAN INTERNATIONAL COOPERATION AGENCY TOKYO	DWG. NO. 1 - 5

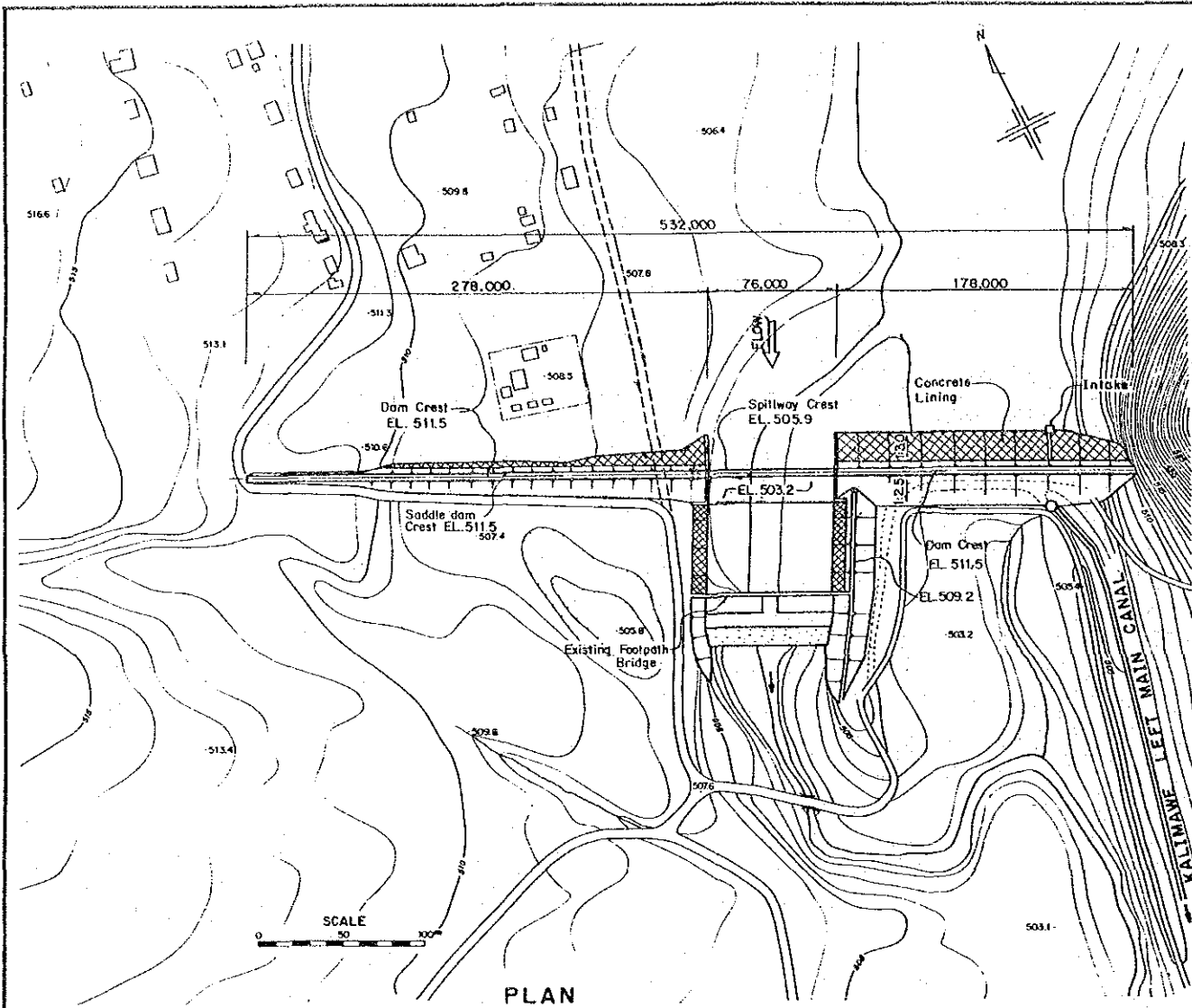

PLAN

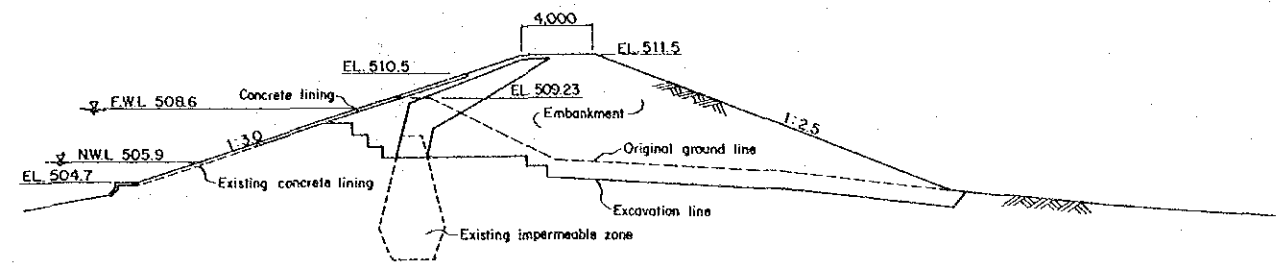

TYPICAL CROSS SECTION

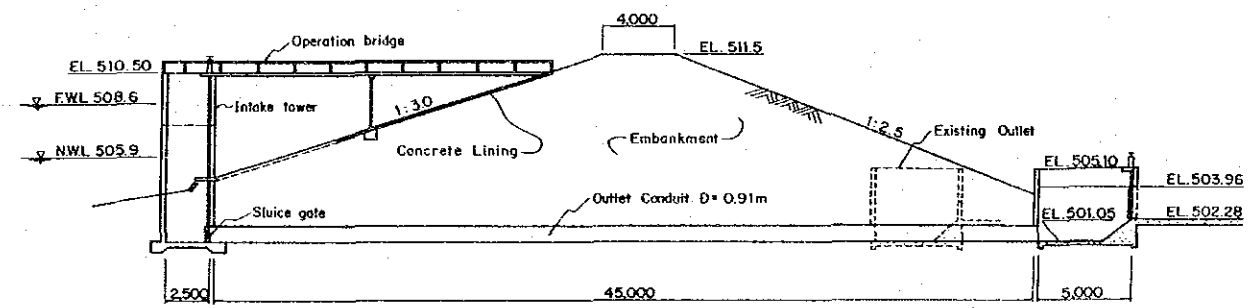

PROFILE OF INTAKE

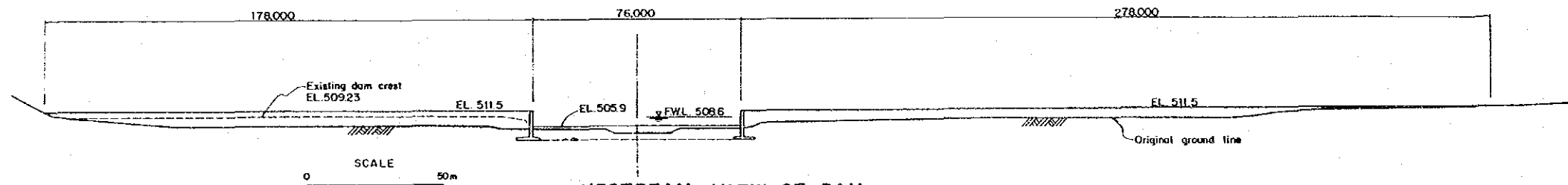

UPSTREAM VIEW OF DAM

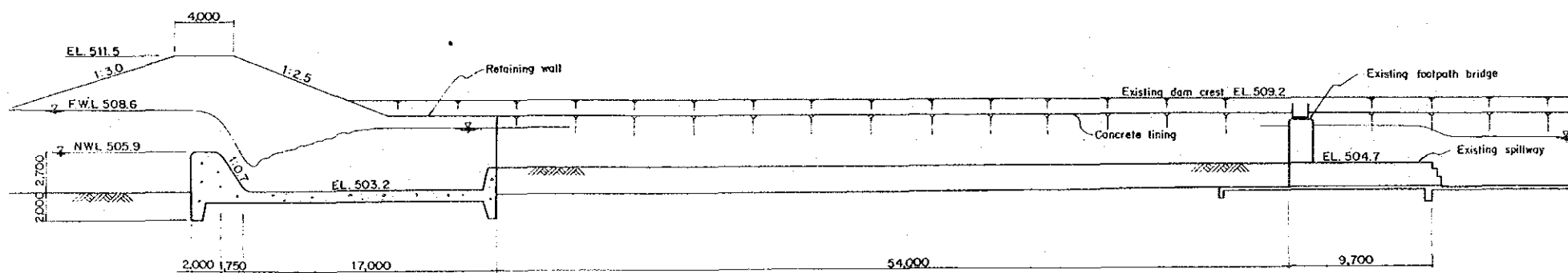

PROFILE OF SPILLWAY

THE UNITED REPUBLIC OF TANZANIA KILIMANJARO REGION THE MKOMAZI VALLEY AREA IRRIGATION DEVELOPMENT PROJECT	
TITLE OF DRAWING KALIMAWE DAM	
JAPAN INTERNATIONAL COOPERATION AGENCY TOKYO	DWG. No. 2-1

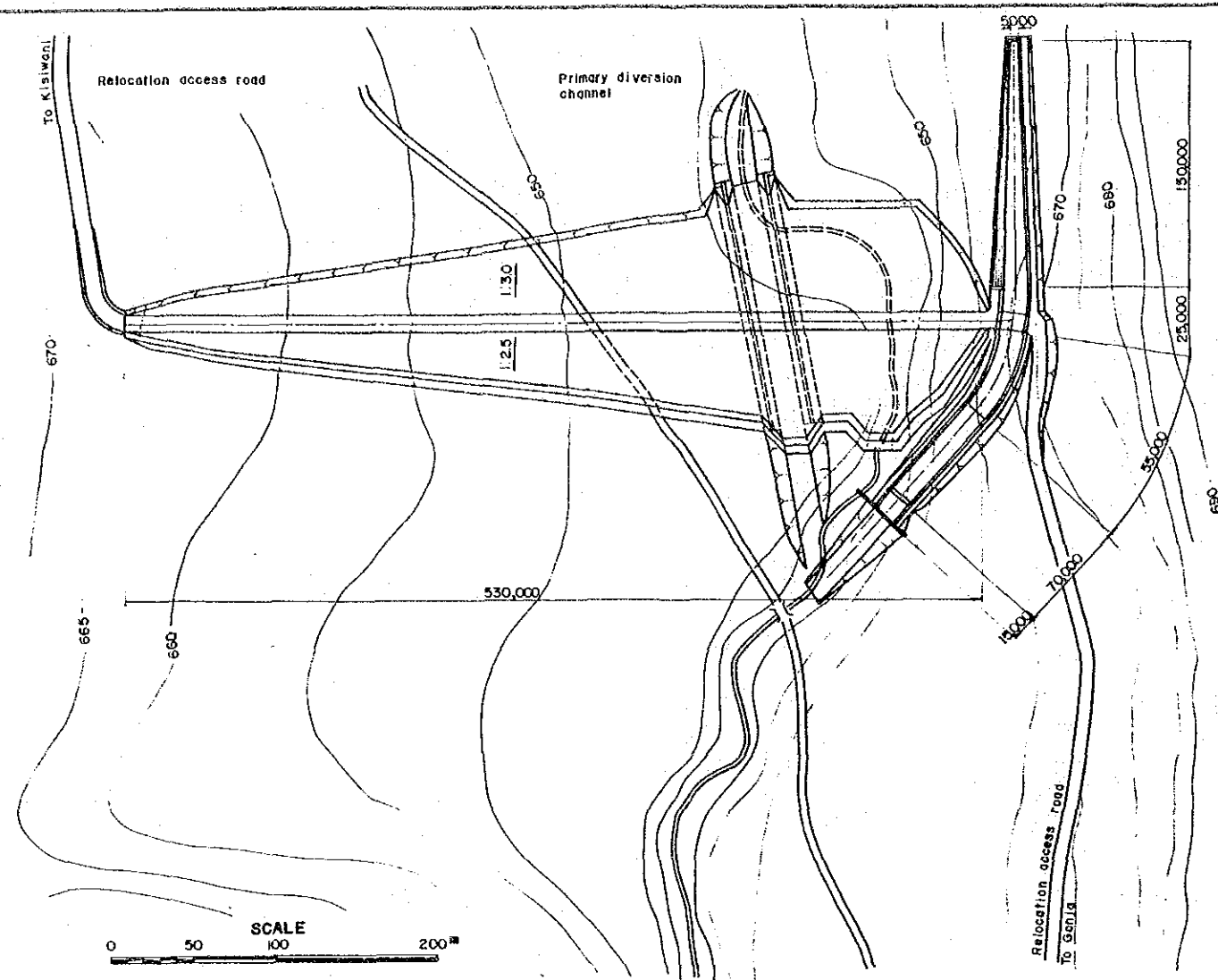

PLAN

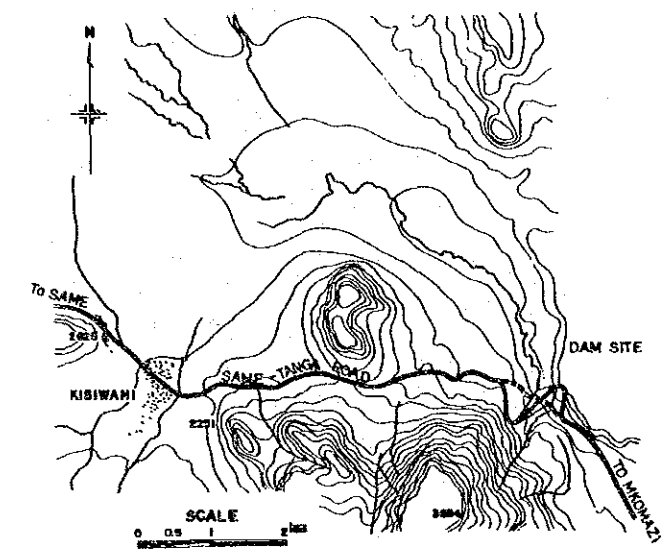

LOCATION MAP

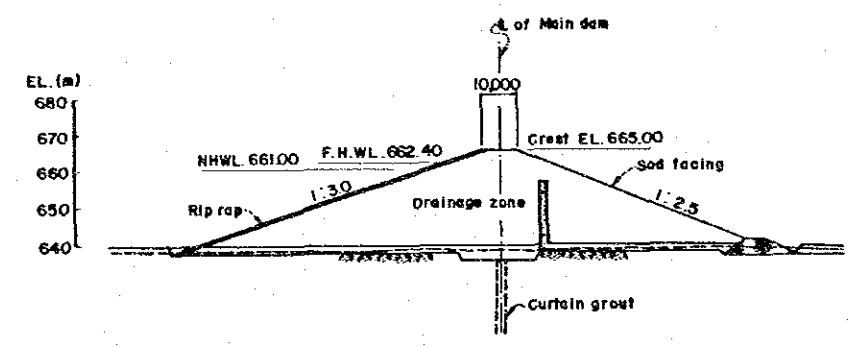

TYPICAL CROSS SECTION

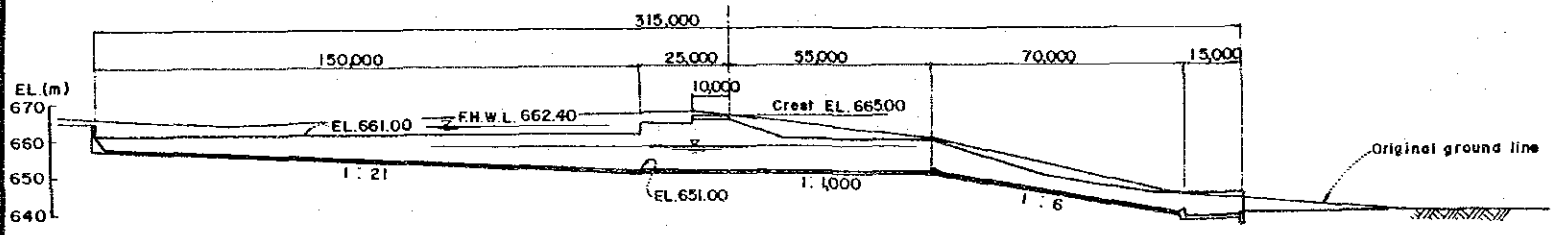

PROFILE OF SPILLWAY

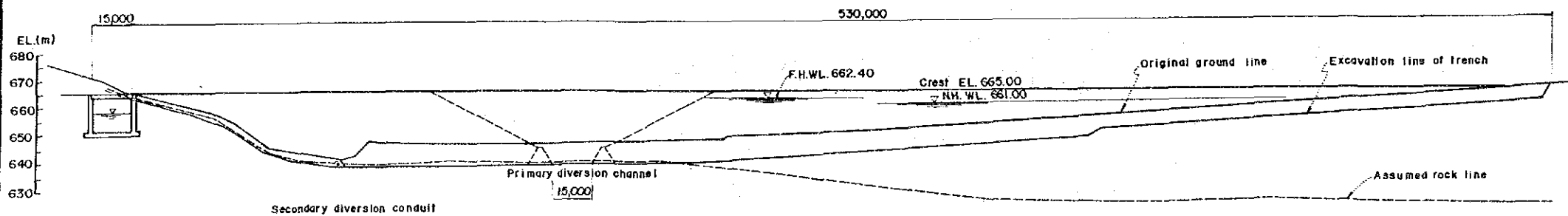

UPSTREAM VIEW OF DAM

THE UNITED REPUBLIC OF TANZANIA KILIMANJARO REGION THE MKOMAZI VALLEY AREA IRRIGATION DEVELOPMENT PROJECT TITLE OF DRAWING	
IGOMA DAM	
JAPAN INTERNATIONAL COOPERATION AGENCY TOKYO	DWG. NO. 2-2

RETAINING WALL

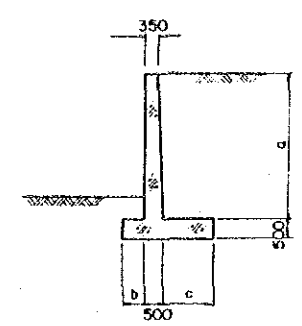

(mm)			
TYPE	a	b	c
B 1	3,900	600	1,400
B 2	3,900 ~2,500	600 ~400	1,400 ~1,100
B 3	2,500 ~2,000	400	1,000

TYPE B

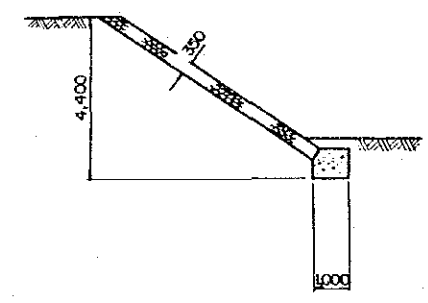

TYPE C

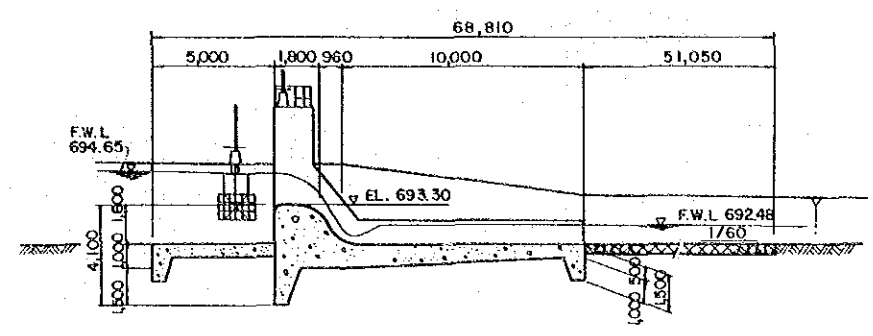

SECTION B-B

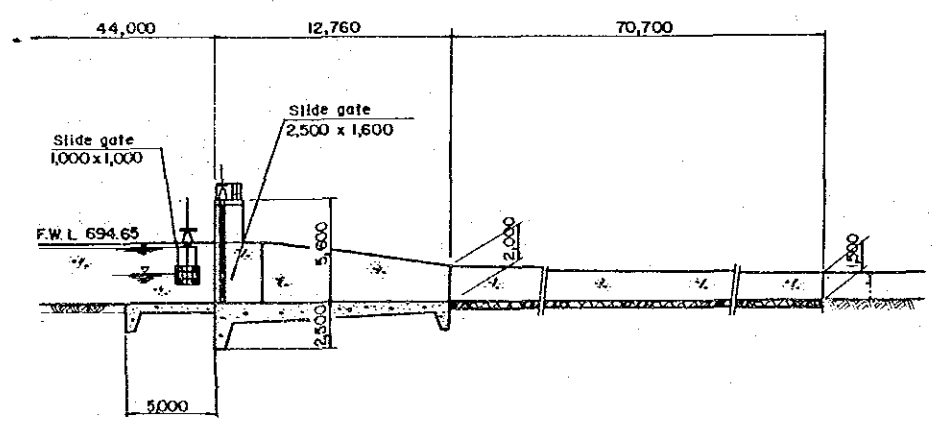

SECTION C-C

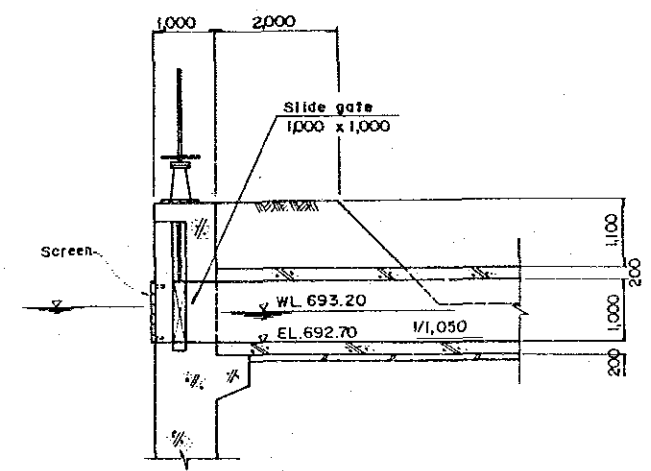

INTAKE GATE

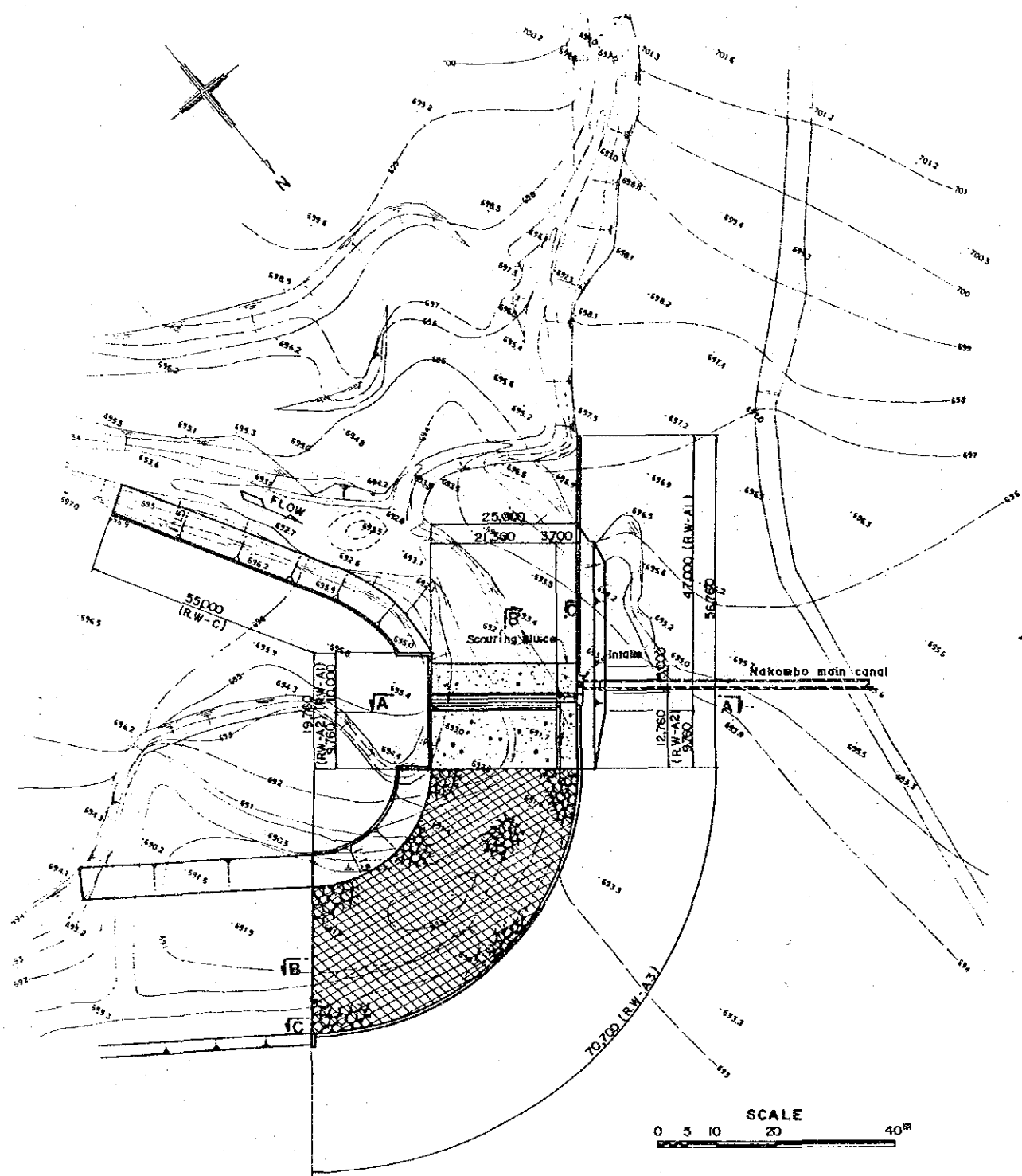

PLAN

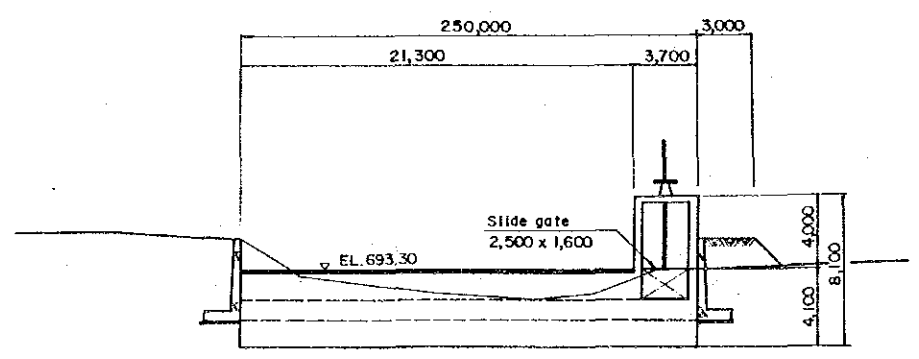

SECTION A-A



THE UNITED REPUBLIC OF TANZANIA
 KILIMANJARO REGION
 THE MKOMAZI VALLEY AREA IRRIGATION DEVELOPMENT PROJECT
 TITLE OF DRAWING
NAKOMBO DIVERSION WEIR
 JAPAN INTERNATIONAL COOPERATION AGENCY
 TOKYO

DWG. NO.
 3-1

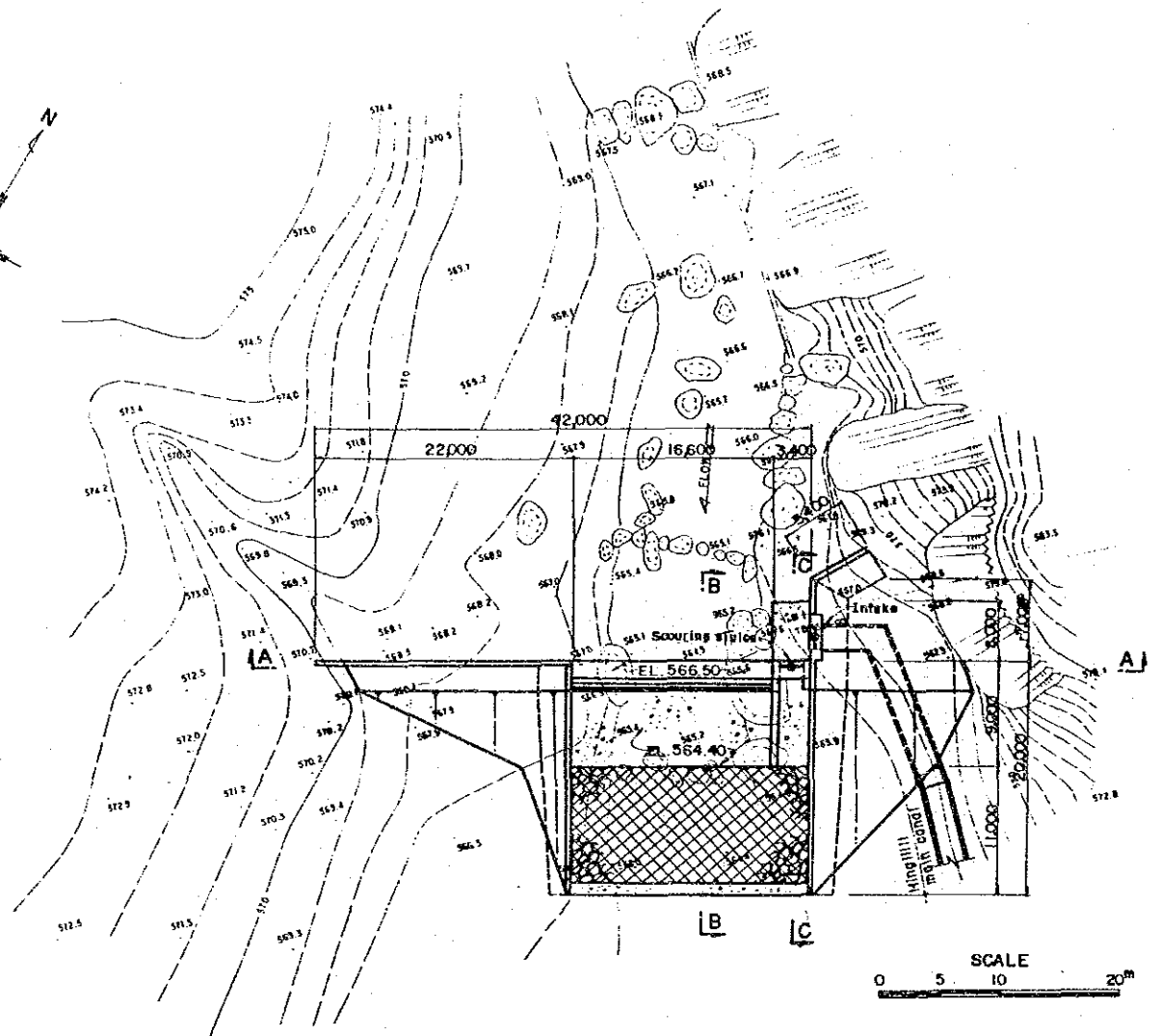
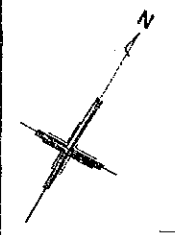

PLAN

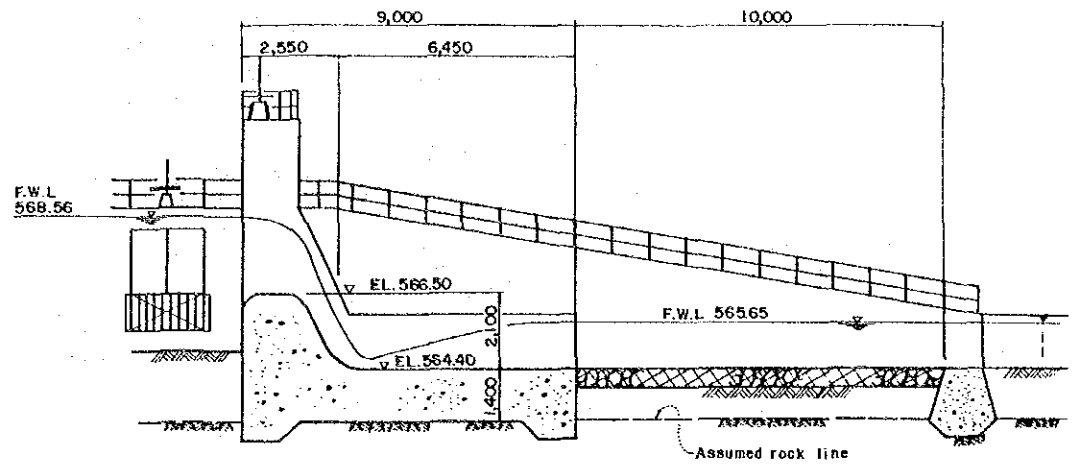

SECTION B-B

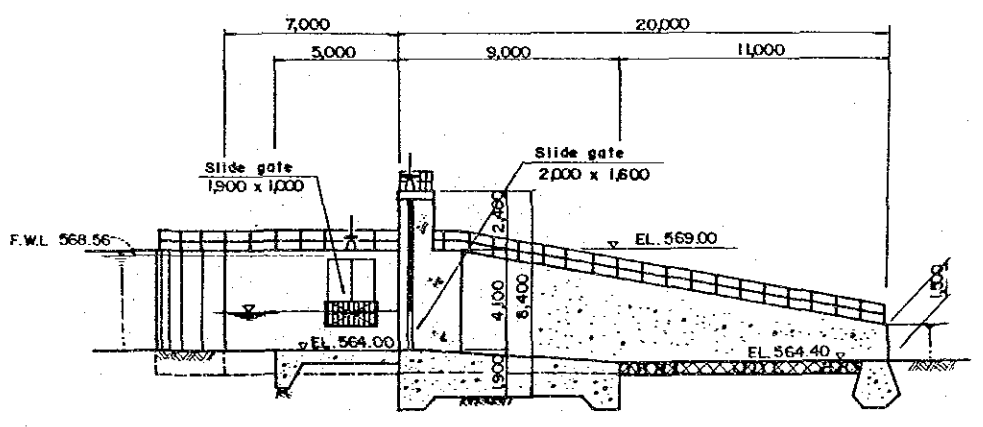

SECTION C-C

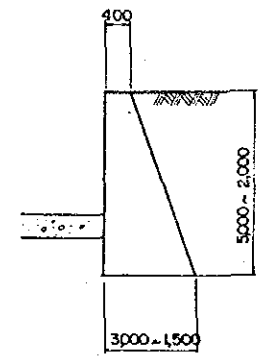

RETAINING WALL

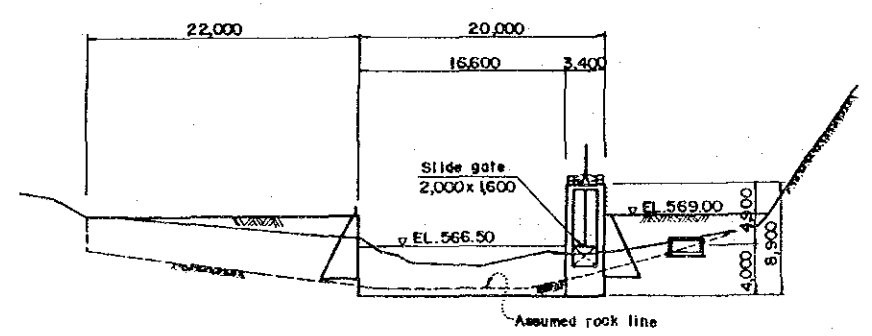

SECTION A-A

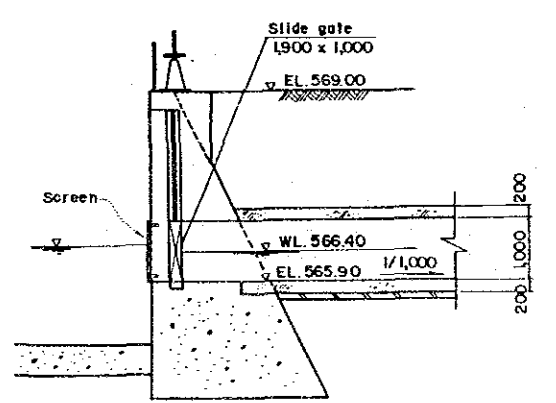

INTAKE GATE

THE UNITED REPUBLIC OF TANZANIA KILIMANJARO REGION THE MKOMAZI VALLEY AREA IRRIGATION DEVELOPMENT PROJECT	
TITLE OF DRAWING HINGILILI DIVERSION WEIR	
JAPAN INTERNATIONAL COOPERATION AGENCY TOKYO	DWG. NO. 3-2

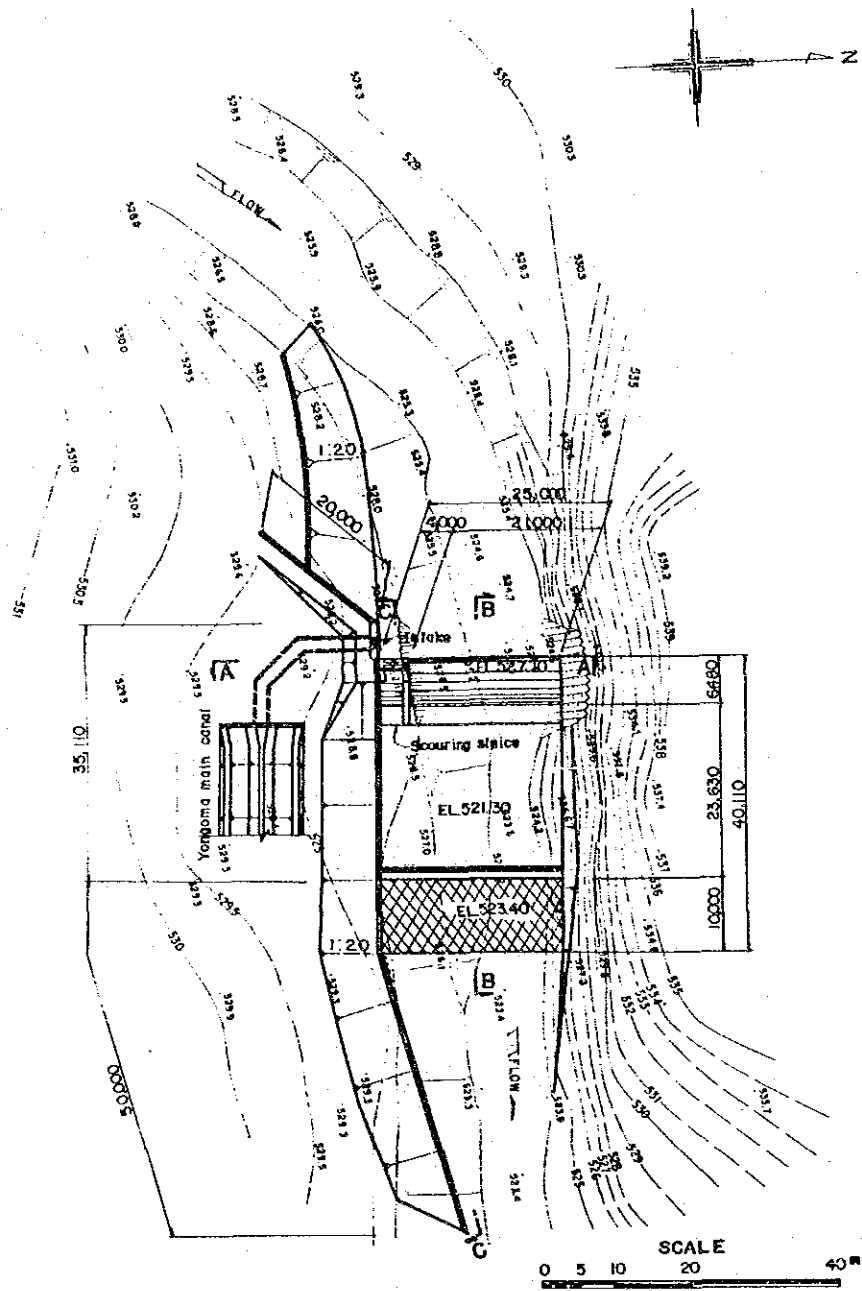

PLAN

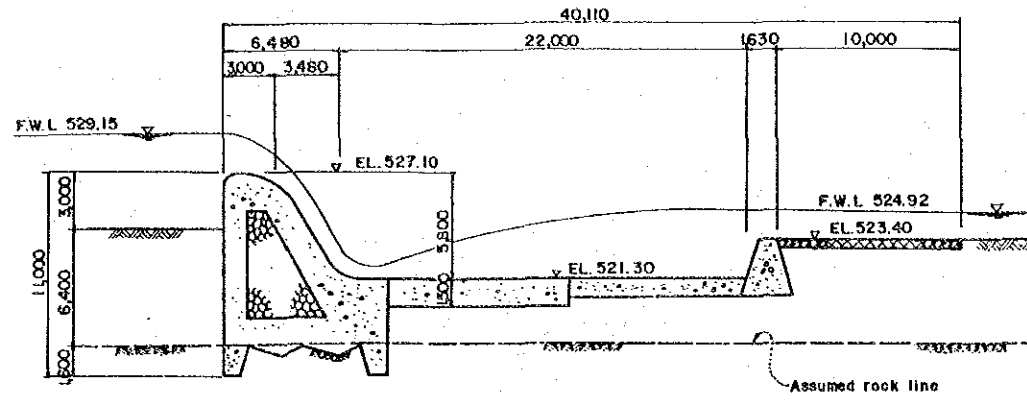

SECTION B-B

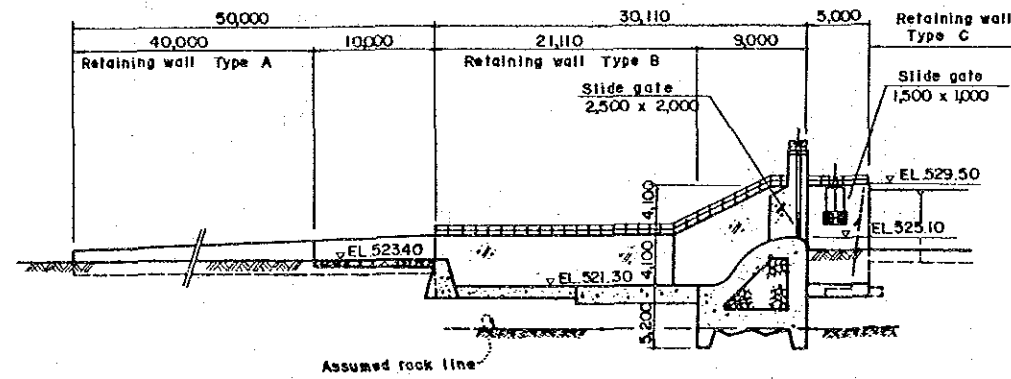

SECTION C-C

RETAINING WALL

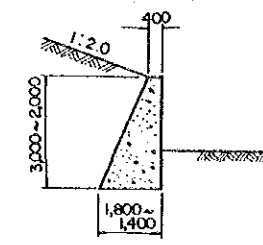

TYPE A

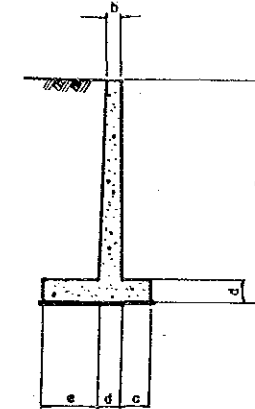

TYPE B

TYPE	a	b	c	d	e
B - 1	9,200~ 6,500	400	1,000~ 500	700~ 500	1,800~ 1,000
B - 2	9,200	1,000	1,000	1,000	1,500
B - 3	9,200	400	-	600	2,000
B - 4	9,200~ 5,100	400	-	600	2,000
B - 5	5,100	350	-	500	1,500

(mm)

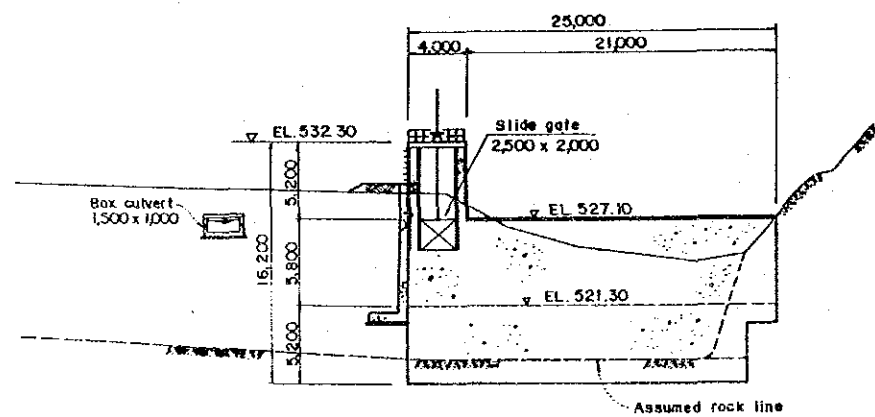

SECTION A-A

DL 510.00th

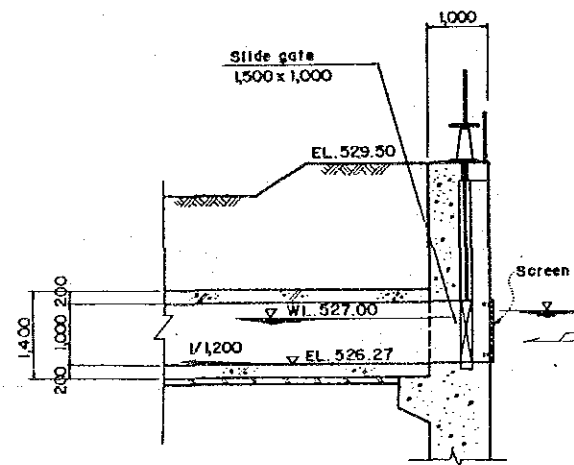

INTAKE GATE

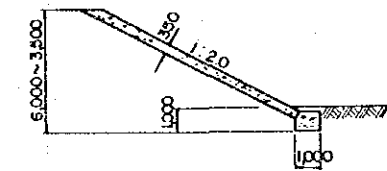

TYPE C

THE UNITED REPUBLIC OF TANZANIA
KILIMANJARO REGION
THE MKOMAZI VALLEY AREA IRRIGATION DEVELOPMENT PROJECT
TITLE OF DRAWING
YONGOMA DIVERSION WEIR
JAPAN INTERNATIONAL COOPERATION AGENCY TOKYO
DWG. NO.
3 - 3

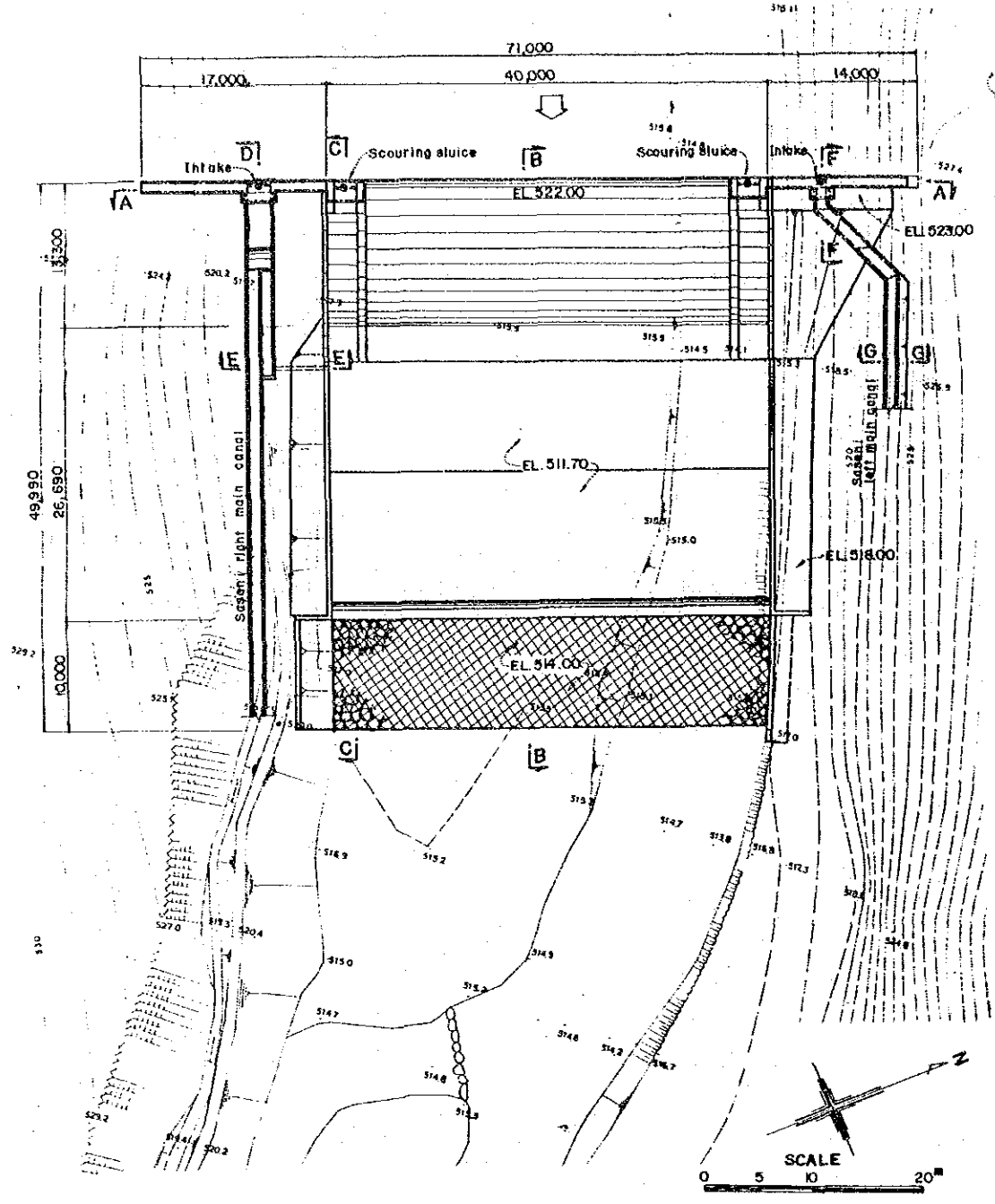

PLAN

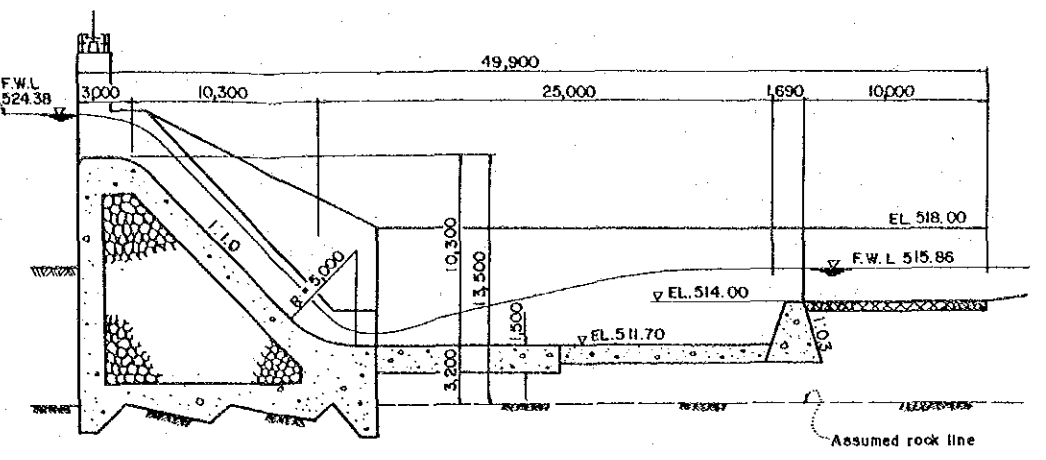

SECTION B-B

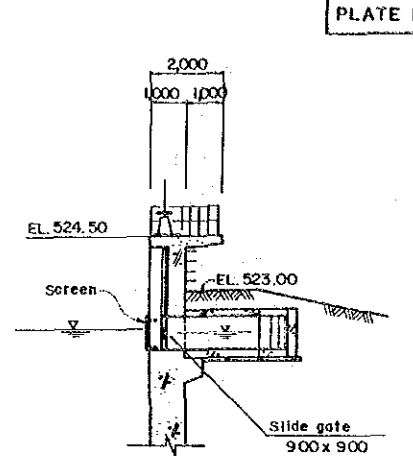

SECTION F-F

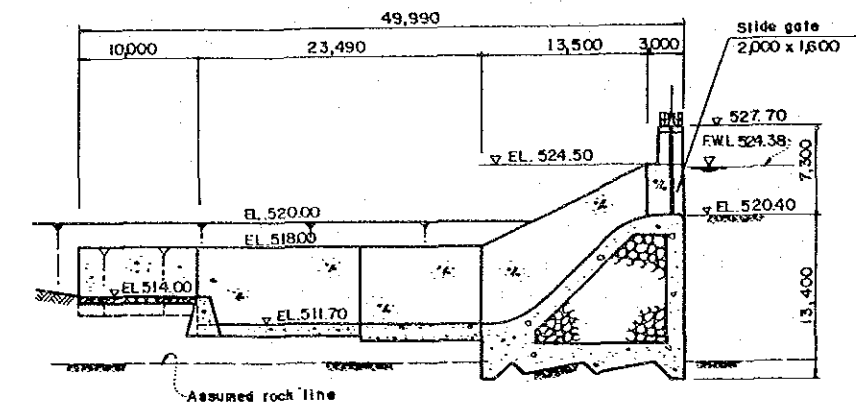

SECTION C-C

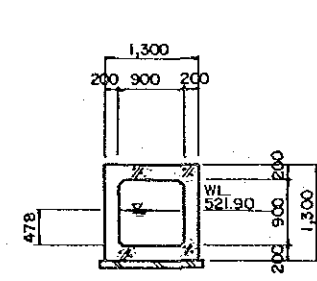

CULVERT

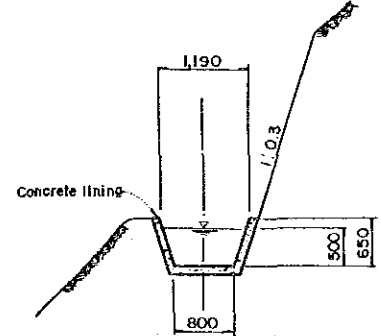

SECTION G-G

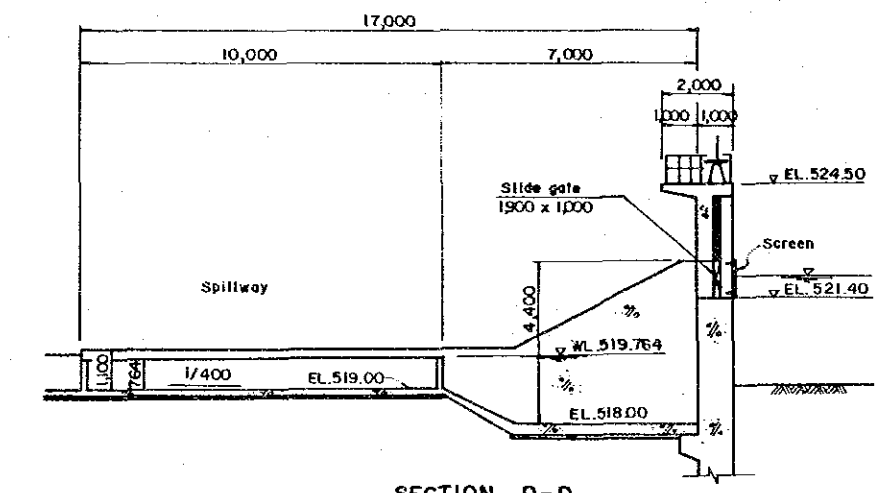

SECTION D-D

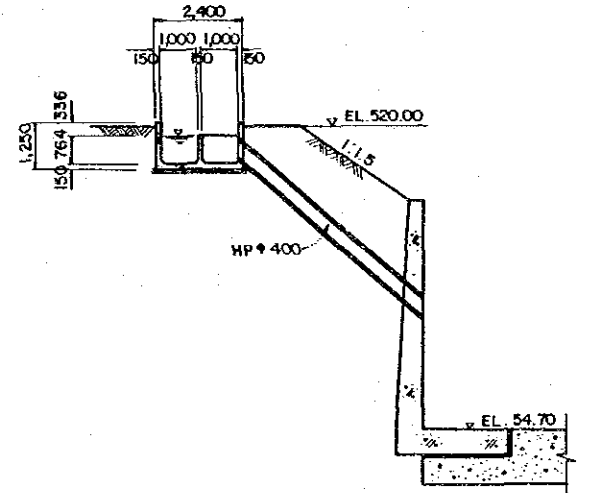

SECTION E-E

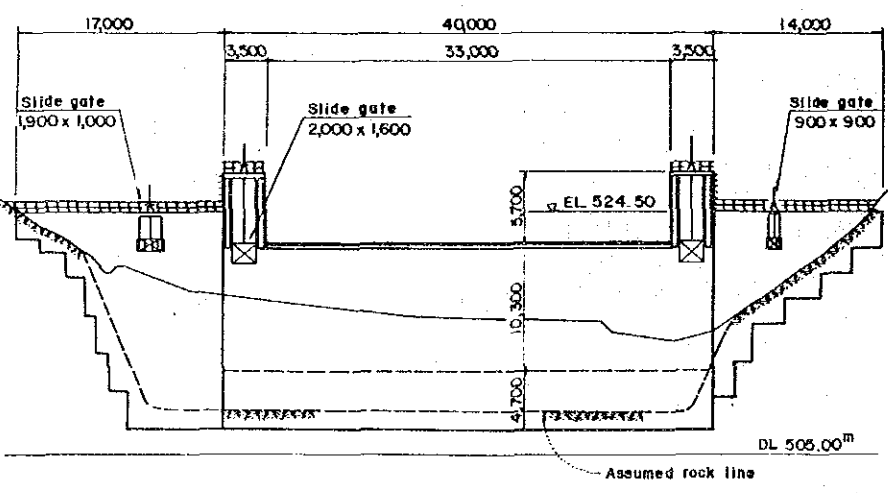

SECTION A-A

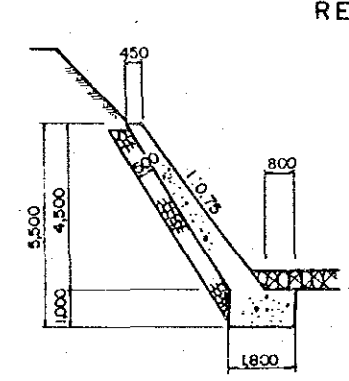

TYPE A

Type	H (mm)	h (mm)
B-1	14,500	700
B-2	4,500 ~ 8,000	700
B-3	7,000	700
B-4	7,300	1,000

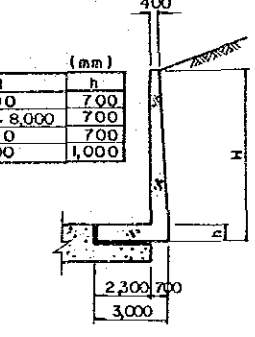

TYPE B

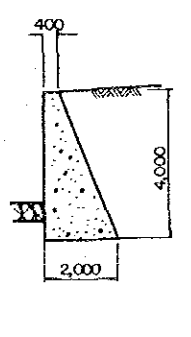

TYPE C

THE UNITED REPUBLIC OF TANZANIA
 KILIMANJARO REGION
 THE MKOMAZI VALLEY AREA IRRIGATION DEVELOPMENT PROJECT
 TITLE OF DRAWING
SASENI DIVERSION WEIR
 JAPAN INTERNATIONAL COOPERATION AGENCY TOKYO
 DWG. NO.
 3-4

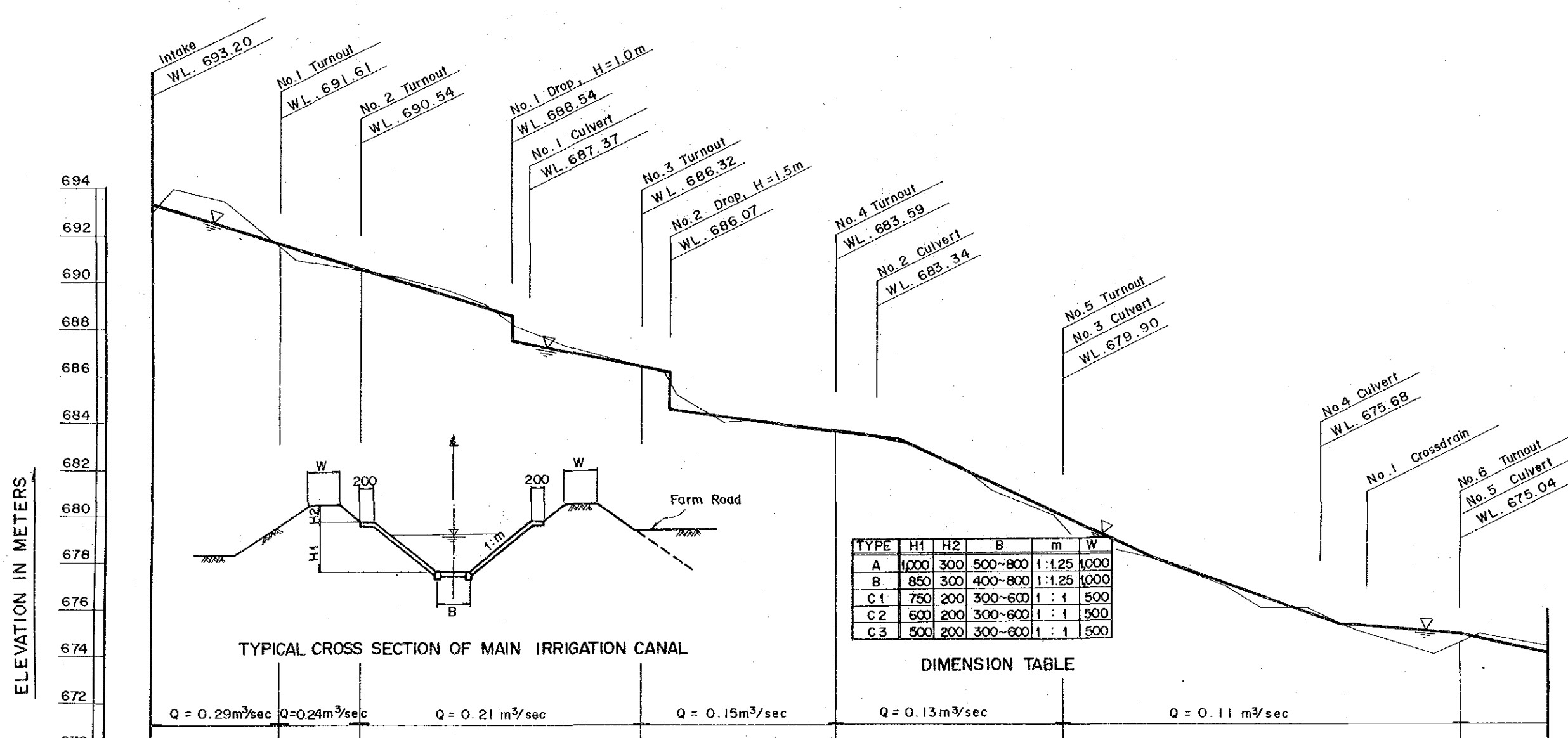

CANAL TYPE	C3																												
CANAL SLOPE	1/160		1/240		1/370		1/110		1/150		1/860		1/220																
GROUND SURFACE ELEVATION	693.0	692.6	690.7	689.8	687.9	686.6	684.3	683.8	683.2	681.1	678.9	677.7	676.0	675.1	674.4	674.4													
REDUCED DISTANCE	0	200	270	400	440	600	760	800	1,000	1,040	1,100	1,200	1,400	1,460	1,550	1,600	1,800	1,950	2,000	2,150	2,200	2,400	2,510	2,560	2,600	2,610	2,800	2,810	3,000

THE UNITED REPUBLIC OF TANZANIA
 KILIMANJARO REGION
 THE MKOMAZI VALLEY AREA IRRIGATION DEVELOPMENT PROJECT
 TITLE OF DRAWING
 PROFILE OF NAKOMBO MAIN CANAL (1/2)
 - KISIWANI SCHEME -
 JAPAN INTERNATIONAL COOPERATION AGENCY
 TOKYO

DWG. NO.
 4-1

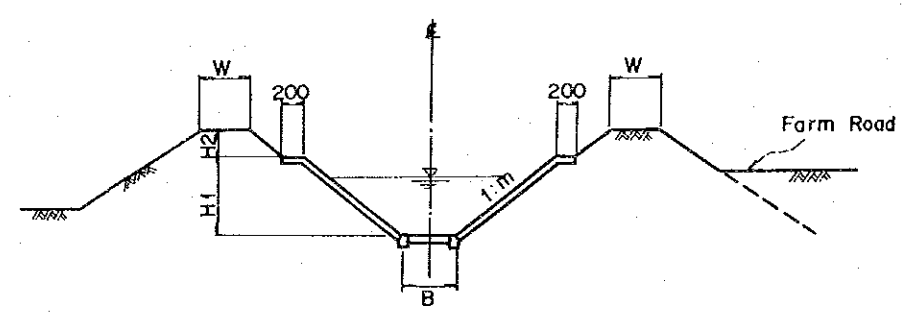
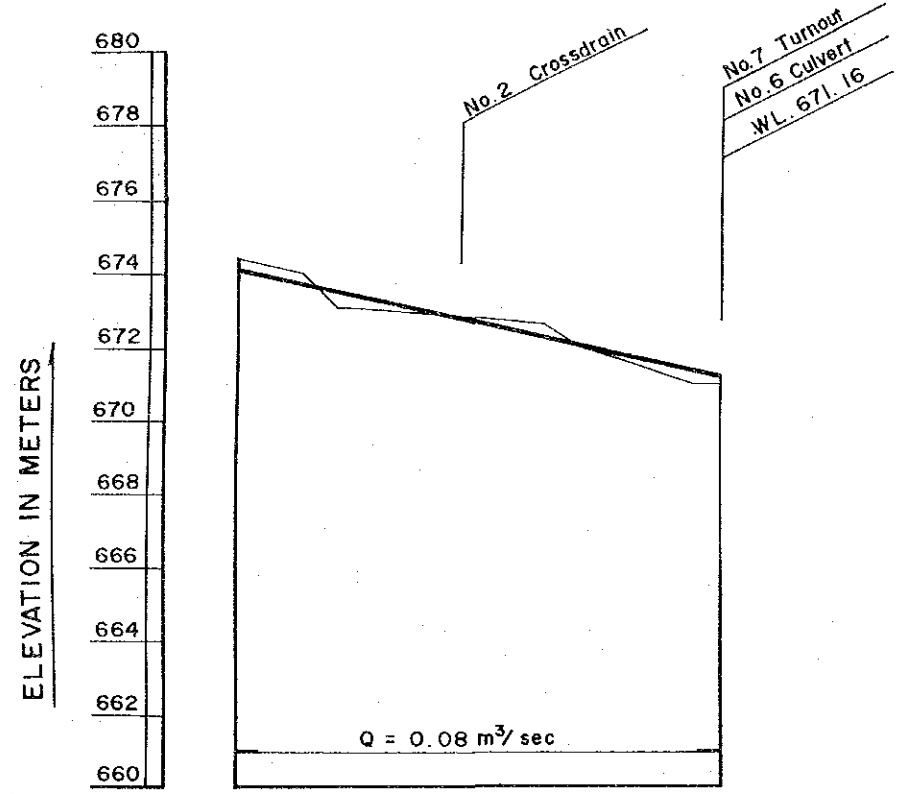

TYPICAL CROSS SECTION OF MAIN IRRIGATION CANAL

CANAL TYPE	C3				
CANAL SLOPE	1/220				
GROUND SURFACE ELEVATION	674.4	672.9	672.6	671.1	671.1
REDUCED DISTANCE	3.000	3.200	3.300	3.400	3.600 3.650

TYPE	H1	H2	B	m	W
A	1000	300	500-800	1:1.25	1000
B	850	300	400-800	1:1.25	1000
C1	750	200	300-600	1:1	500
C2	600	200	300-600	1:1	500
C3	500	200	300-600	1:1	500

DIMENSION TABLE

THE UNITED REPUBLIC OF TANZANIA KILIMANJARO REGION THE MKOMAZI VALLEY AREA IRRIGATION DEVELOPMENT PROJECT	
TITLE OF DRAWING PROFILE OF NAKOMBO MAIN CANAL (2/2) - KISIWANI SCHEME -	
JAPAN INTERNATIONAL COOPERATION AGENCY TOKYO	DWG. NO. 4-2

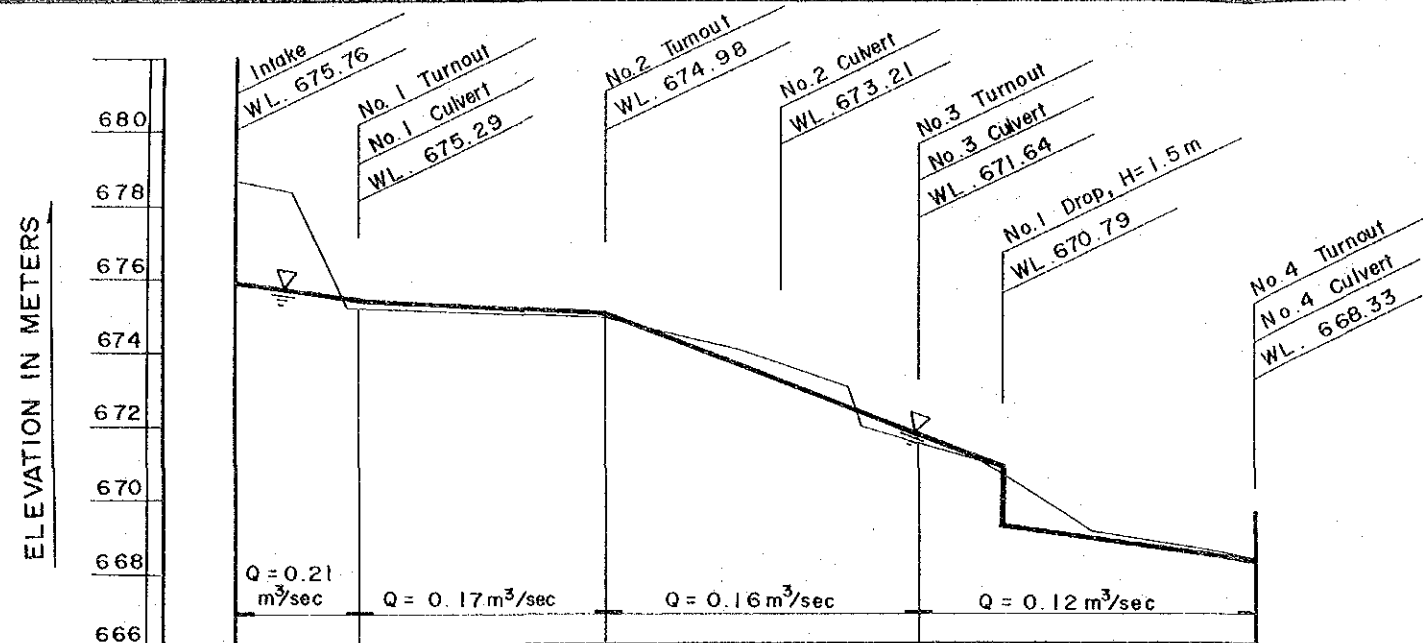

CANAL TYPE	C3								
CANAL SLOPE	1/400	1 / 1,100		1 / 130		1 / 390			
GROUND SURFACE ELEVATION	678.6	675.1	675.0	674.4	673.2	671.0	668.9	668.3	
REDUCED DISTANCE	0	165 200	400	500	600	730 800	920 1,000 1,030	1,200	1,380

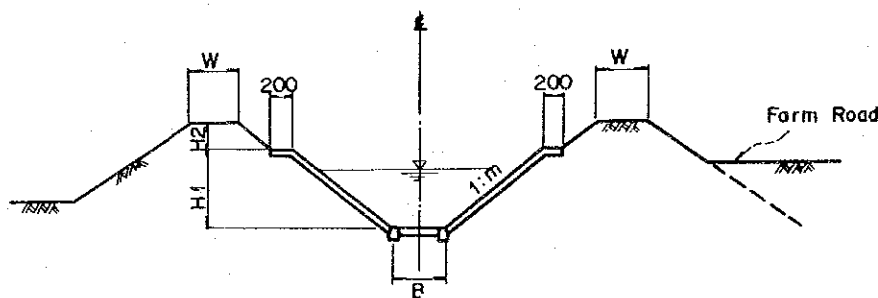

TYPICAL CROSS SECTION OF MAIN IRRIGATION CANAL

TYPE	H1	H2	B	m	W
A	1000	300	500~800	1:1.25	1000
B	850	300	400~800	1:1.25	1000
C1	750	200	300~600	1:1	500
C2	600	200	300~600	1:1	500
C3	500	200	300~600	1:1	500

DIMENSION TABLE

THE UNITED REPUBLIC OF TANZANIA KILIMANJARO REGION THE MKOMAZI VALLEY AREA IRRIGATION DEVELOPMENT PROJECT	
TITLE OF DRAWING PROFILE OF KISIWANI MAIN CANAL - KISIWANI SCHEME -	
JAPAN INTERNATIONAL COOPERATION AGENCY TOKYO	DWG. NO. 4 - 3

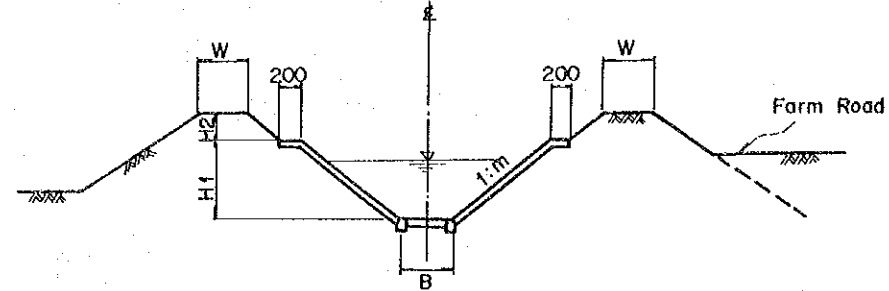
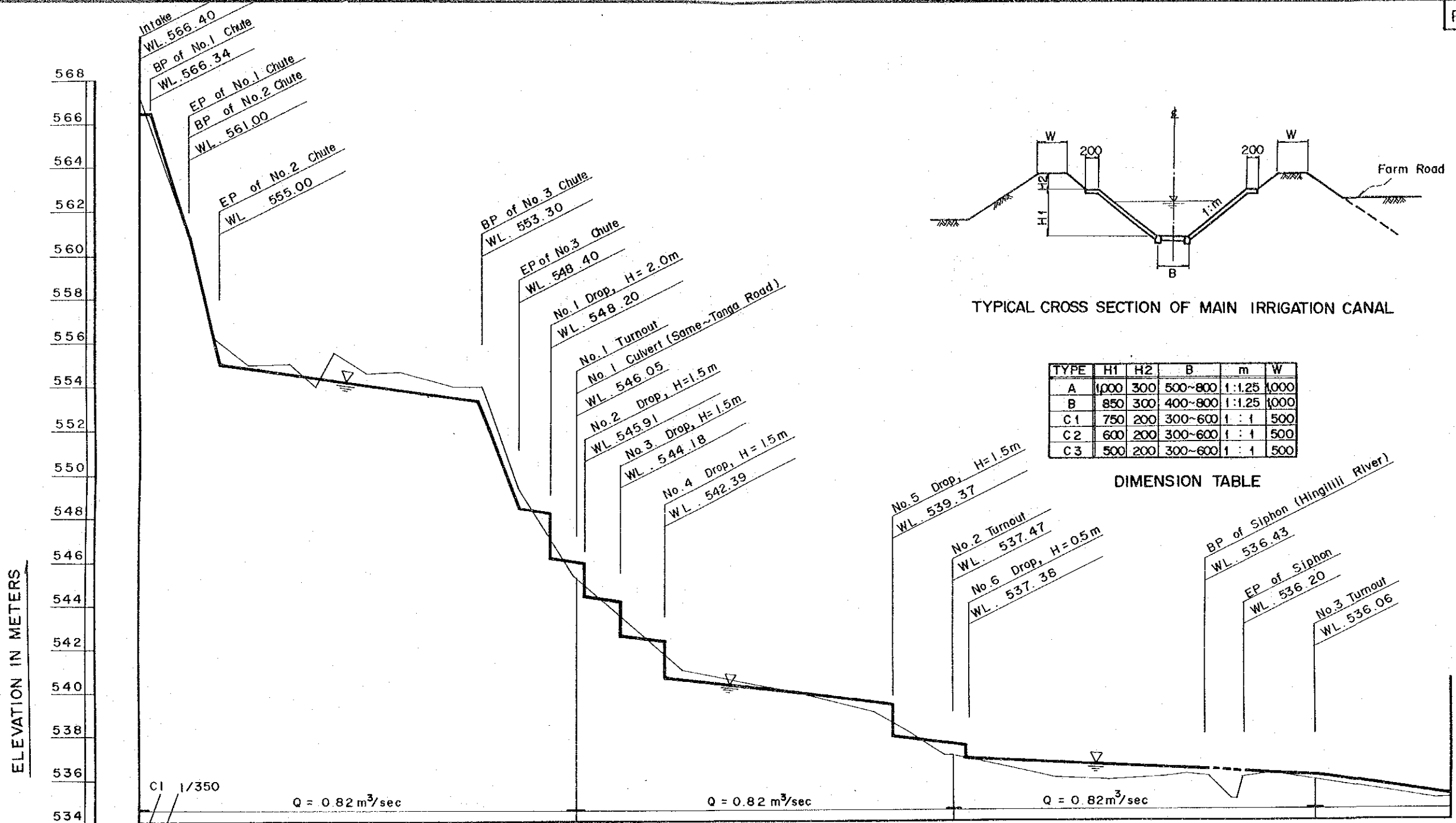

TYPICAL CROSS SECTION OF MAIN IRRIGATION CANAL

TYPE	H1	H2	B	m	W
A	1000	300	500~800	1:1.25	1000
B	850	300	400~800	1:1.25	1000
C 1	750	200	300~600	1:1	500
C 2	600	200	300~600	1:1	500
C 3	500	200	300~600	1:1	500

DIMENSION TABLE

CANAL TYPE	C1
CANAL SLOPE	1/350
GROUND SURFACE ELEVATION	567.0
REDUCED DISTANCE	0

C1		C1		B		C2	
1/350		1/350		1/1,200		1/340	
567.0	555.7	554.0	554.6	553.0	545.2	541.7	540.4
0	20	110	185	200	400	600	780
					800	870	940
					1,000	1,020	1,100
					1,200	1,400	1,600
					1,800	1,870	1,900
					2,000	2,200	2,400
					2,440	2,530	2,600
					2,690	2,800	3,000

THE UNITED REPUBLIC OF TANZANIA
 KILIMANJARO REGION
 THE MKOMAZI VALLEY AREA IRRIGATION DEVELOPMENT PROJECT
 TITLE OF DRAWING
 PROFILE OF HINGILILI MAIN CANAL (1/2)
 - GONJA SCHEME -
 JAPAN INTERNATIONAL COOPERATION AGENCY
 TOKYO

ELEVATION IN METERS

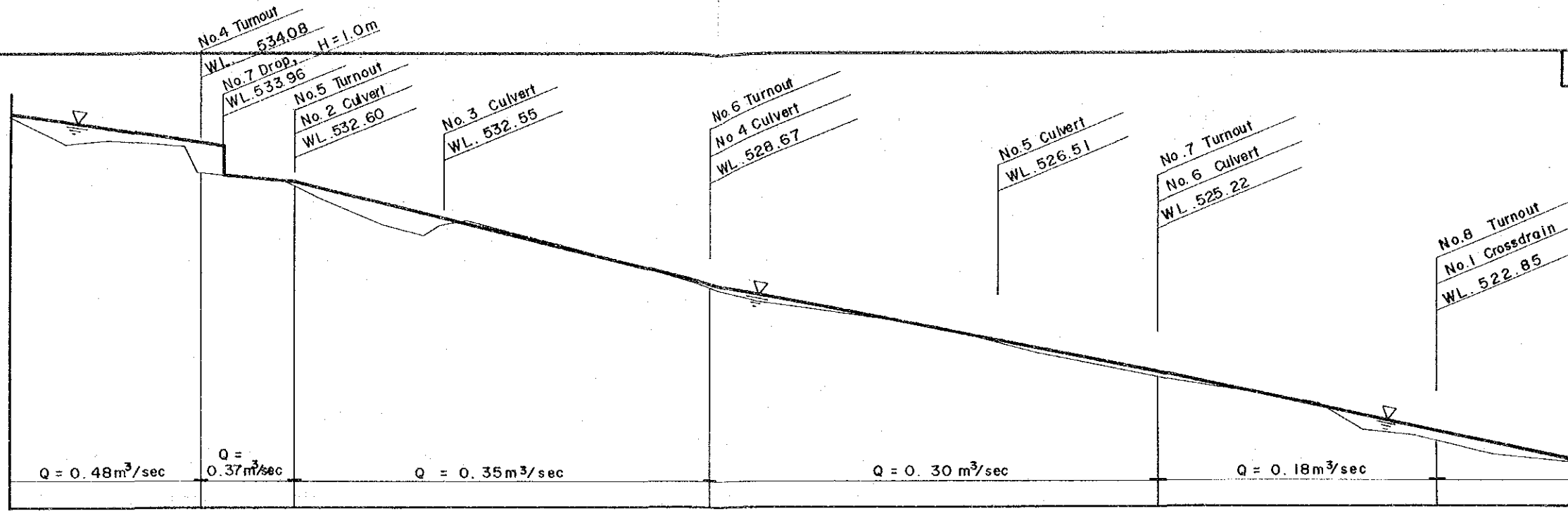

CANAL TYPE	C2		C3	C2	C3																	
CANAL SLOPE	1/340		1/390		1/210										1/260		1/230					
GROUND SURFACE ELEVATION	535.0	534.2	532.8	531.7	530.8	530.4	529.3	528.2	527.5	526.8	525.8	525.0	524.3	522.9	522.2	521.6						
REDUCED DISTANCE	3.000	3.200	3.360	3.400	3.540	3.600	3.800	3.820	4.000	4.200	4.330	4.400	4.600	4.800	4.890	5.000	5.200	5.400	5.600	5.740	5.800	6.000

ELEVATION IN METERS

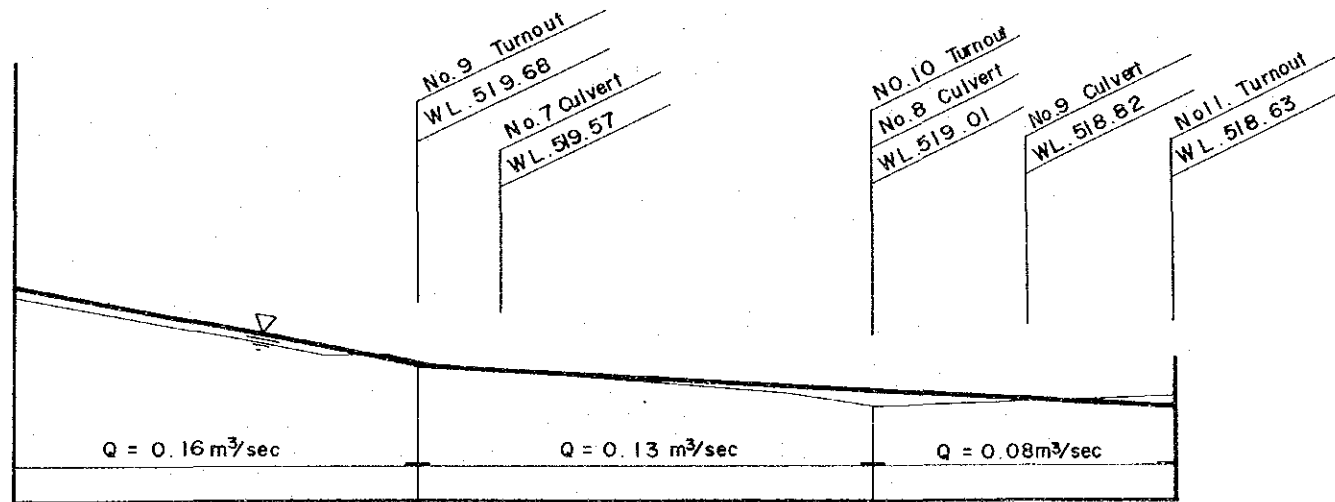

CANAL TYPE	C3													
CANAL SLOPE	1/270				1/1,000				1/1,500					
GROUND SURFACE ELEVATION	521.6	520.8	520.1	519.7	519.4	519.1	518.7	518.8	518.8	518.8	518.8	518.8		
REDUCED DISTANCE	6.000	6.050	6.200	6.400	6.540	6.600	6.650	6.800	7.000	7.150	7.200	7.360	7.400	7.560

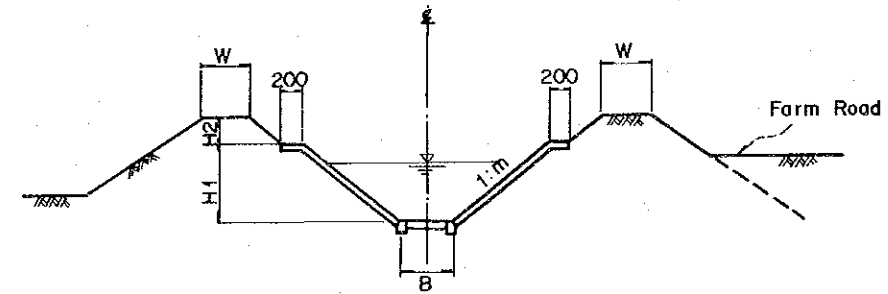

TYPICAL CROSS SECTION OF MAIN IRRIGATION CANAL

TYPE	H1	H2	B	m	W
A	1000	300	500~800	1:1.25	1000
B	850	300	400~800	1:1.25	1000
C1	750	200	300~600	1:1	500
C2	600	200	300~600	1:1	500
C3	500	200	300~600	1:1	500

DIMENSION TABLE

THE UNITED REPUBLIC OF TANZANIA
 KILIMANJARO REGION
 THE MKOMAZI VALLEY AREA IRRIGATION DEVELOPMENT PROJECT
 TITLE OF DRAWING
 PROFILE OF HINGILILI MAIN CANAL (2/2)
 - GONJA SCHEME -
 JAPAN INTERNATIONAL COOPERATION AGENCY DWG. NO.
 TOKYO 4-5

ELEVATION IN METERS

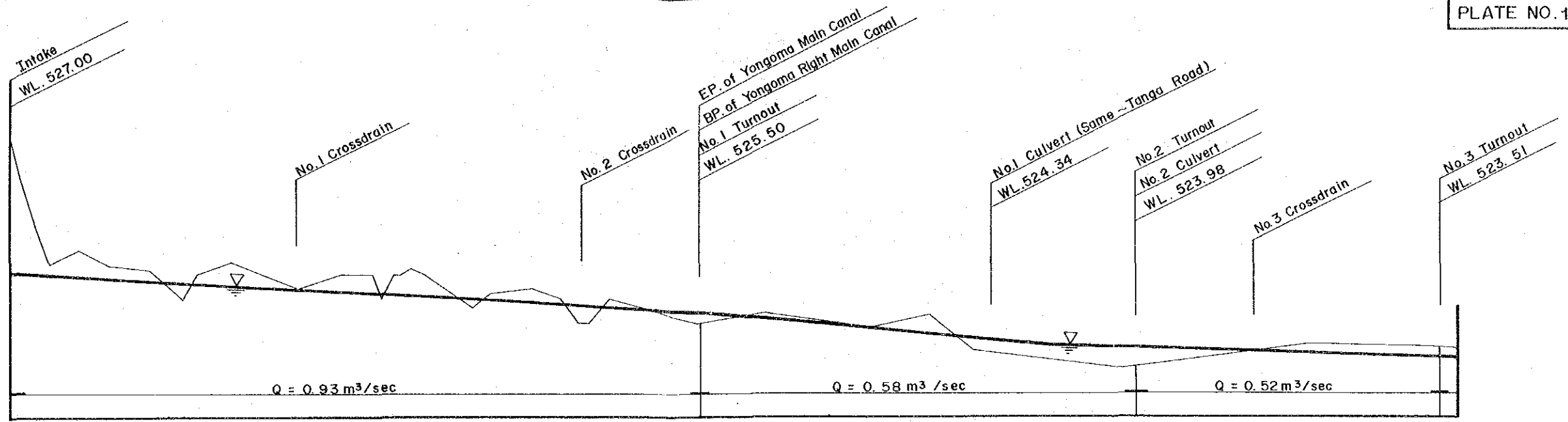

CANAL TYPE	B										C 1				B										
CANAL SLOPE	1/950										1/520				1/1,550										
GROUND SURFACE ELEVATION	532.6	527.3	527.2	526.5	527.0	526.2	525.4	525.1	525.3	524.9	523.8	523.2	523.3	523.8	524.0	523.9									
REDUCED DISTANCE	0	200	400	580	600	800	850	1,000	1,170	1,200	1,400	1,430	1,600	1,800	2,000	2,030	2,110	2,200	2,330	2,400	2,580	2,600	2,800	2,960	3,000

ELEVATION IN METERS

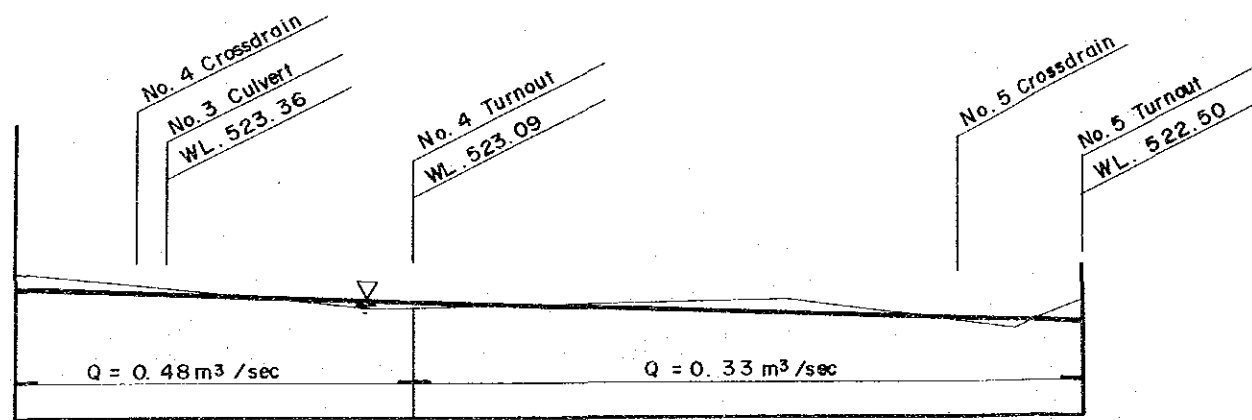

CANAL TYPE	C 1														
CANAL SLOPE	1/1,550														
GROUND SURFACE ELEVATION	523.9	523.5	523.1	523.0	523.1	523.2	522.8	522.9	523.1						
REDUCED DISTANCE	3,000	3,160	3,200	3,400	3,530	3,600	3,800	4,000	4,200	4,250	4,400	4,430			

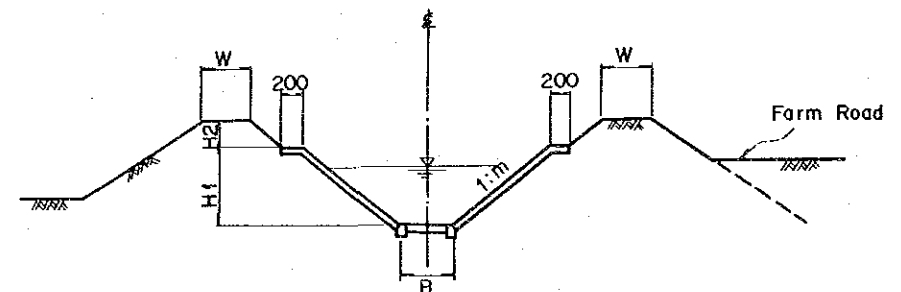

TYPICAL CROSS SECTION OF MAIN IRRIGATION CANAL

TYPE	H1	H2	B	m	W
A	1,000	300	500~800	1:1.25	1,000
B	850	300	400~800	1:1.25	1,000
C 1	750	200	300~600	1:1	500
C 2	600	200	300~600	1:1	500
C 3	500	200	300~600	1:1	500

DIMENSION TABLE

THE UNITED REPUBLIC OF TANZANIA
 KILIMANJARO REGION
 THE MKOMAZI VALLEY AREA IRRIGATION DEVELOPMENT PROJECT
 TITLE OF DRAWING
 PROFILE OF YONGOMA MAIN CANAL
 & YONGOMA RIGHT MAIN CANAL
 - NDUNGU SCHEME -
 JAPAN INTERNATIONAL COOPERATION AGENCY DWG. NO.
 TOKYO 4-6

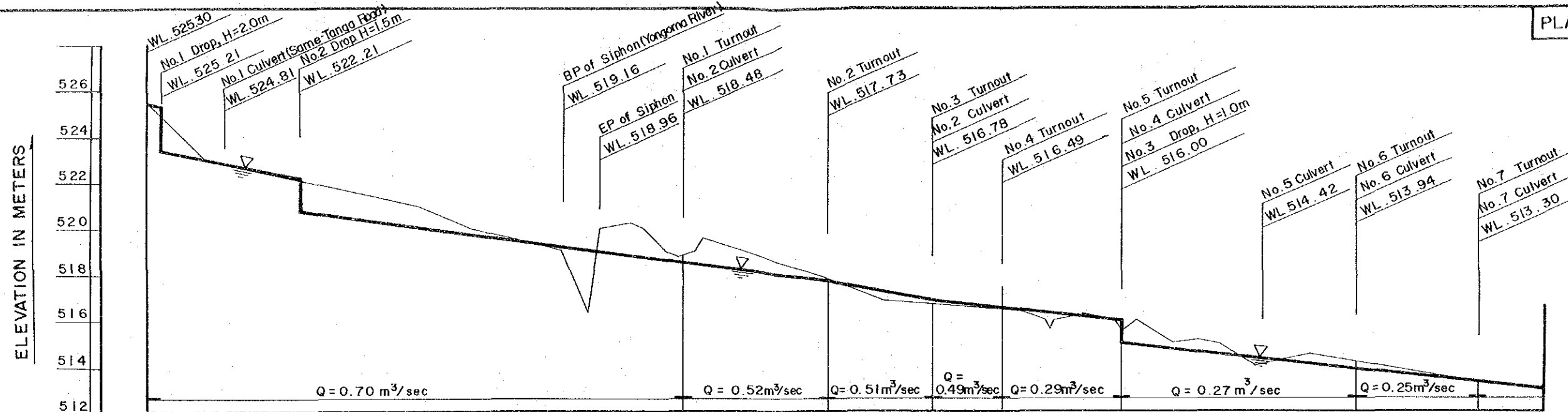

CANAL TYPE	C1			C1		C2	C1	C3																			
CANAL SLOPE	1/350			1/430		1/230	1/520	1/560			1/410	1/670															
GROUND SURFACE ELEVATION	525.4	522.7	521.8	520.9	519.5	520.1	519.6	518.3	516.9	516.5	516.2	515.1	514.1	514.2	513.5	512.9											
REDUCED DISTANCE	0	30	170	200	330	400	600	800	900	980	1,000	1,160	1,200	1,400	1,480	1,600	1,700	1,800	1,850	2,000	2,100	2,200	2,400	2,600	2,800	2,860	3,000

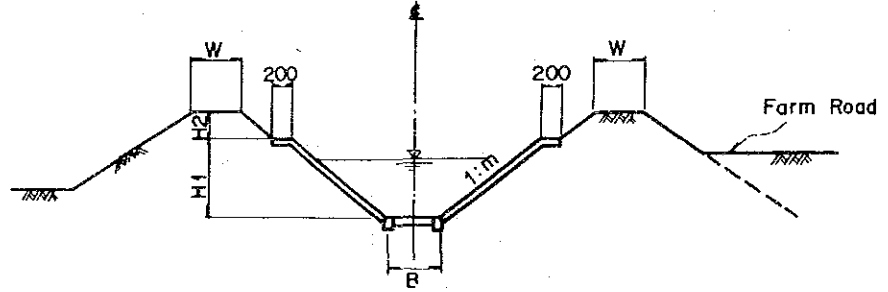
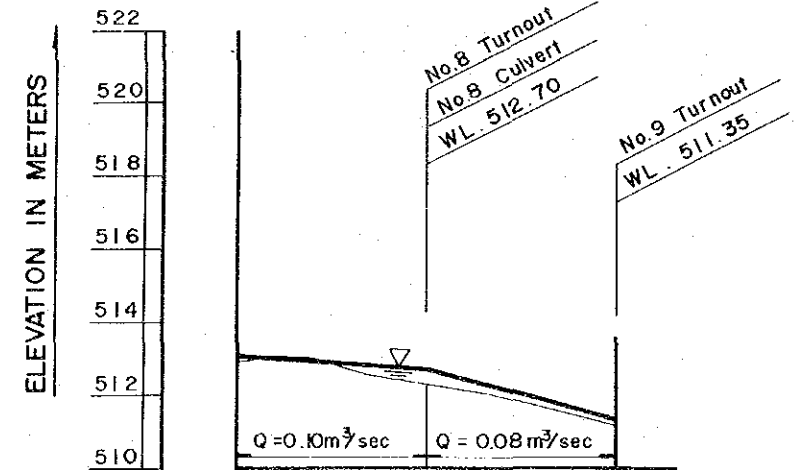

TYPICAL CROSS SECTION OF MAIN IRRIGATION CANAL

TYPE	H1	H2	B	m	W
A	1000	300	500~800	1:1.25	1000
B	850	300	400~800	1:1.25	1000
C1	750	200	300~600	1:1	500
C2	600	200	300~600	1:1	500
C3	500	200	300~600	1:1	500

DIMENSION TABLE

CANAL TYPE	C3				
CANAL SLOPE	1/670		1/200		
GROUND SURFACE ELEVATION	512.9	512.5	511.7	511.2	
REDUCED DISTANCE	3,000	3,200	3,260	3,400	3,520

THE UNITED REPUBLIC OF TANZANIA
 KILIMANJARO REGION
 THE MKOMAZI VALLEY AREA IRRIGATION DEVELOPMENT PROJECT
 TITLE OF DRAWING
 PROFILE OF YONGOMA LEFT MAIN CANAL
 - NDUNGU SCHEME -
 JAPAN INTERNATIONAL COOPERATION AGENCY DWG. NO.
 TOKYO 4-7

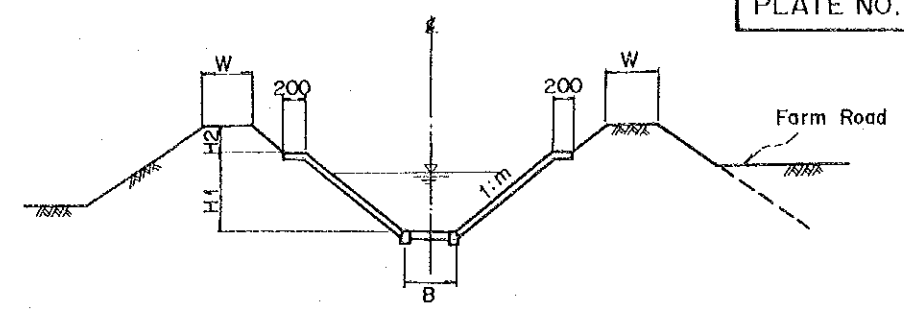

TYPICAL CROSS SECTION OF MAIN IRRIGATION CANAL

TYPE	H1	H2	B	m	W
A	1000	300	500~800	1:1.25	1000
B	850	300	400~800	1:1.25	1000
C1	750	200	300~600	1:1	500
C2	600	200	300~600	1:1	500
C3	500	200	300~600	1:1	500

DIMENSION TABLE

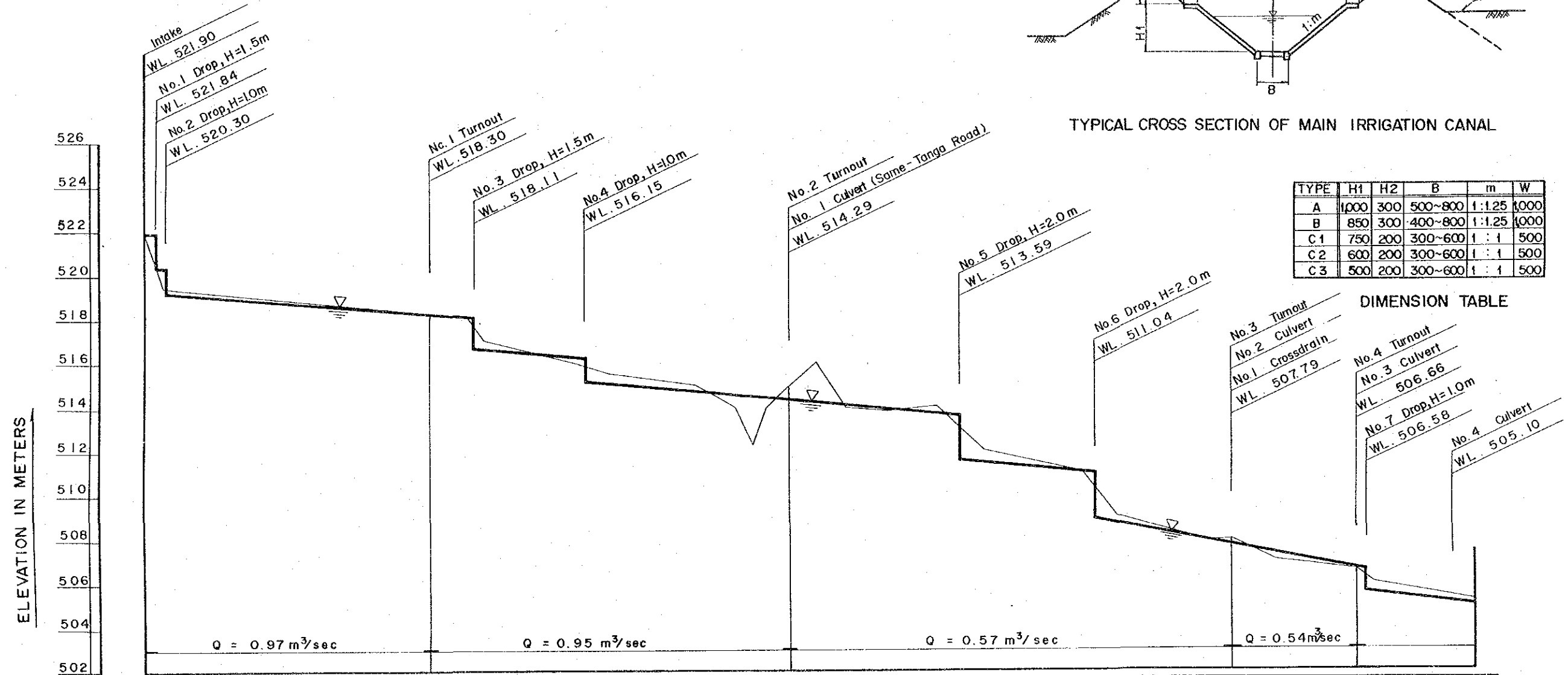

ELEVATION IN METERS

CANAL TYPE	
CANAL SLOPE	1/500
GROUND SURFACE ELEVATION	
REDUCED DISTANCE	

C1										C2															
1/550										1/260															
522.0	519.1	518.7	518.3	516.8	515.9	515.1	513.4	513.9	514.0	509.0	507.9	506.9	505.9	505.2											
0	50	200	400	600	650	750	800	1.000	1.200	1.400	1.470	1.600	1.800	1.850	2.000	2.150	2.200	2.400	2.460	2.600	2.740	2.760	2.800	2.950	3.000

THE UNITED REPUBLIC OF TANZANIA
 KILIMANJARO REGION
 THE MKOMAZI VALLEY AREA IRRIGATION DEVELOPMENT PROJECT
 TITLE OF DRAWING
 PROFILE OF SASANI RIGHT MAIN CANAL (1/2)
 - KIHURIO SCHEME -
 JAPAN INTERNATIONAL COOPERATION AGENCY DWG. NO.
 TOKYO 4-8

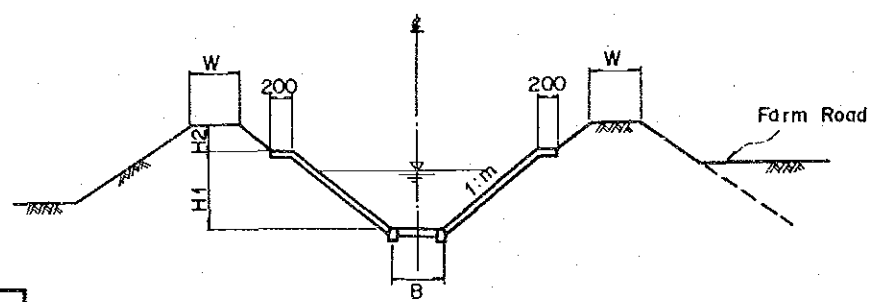
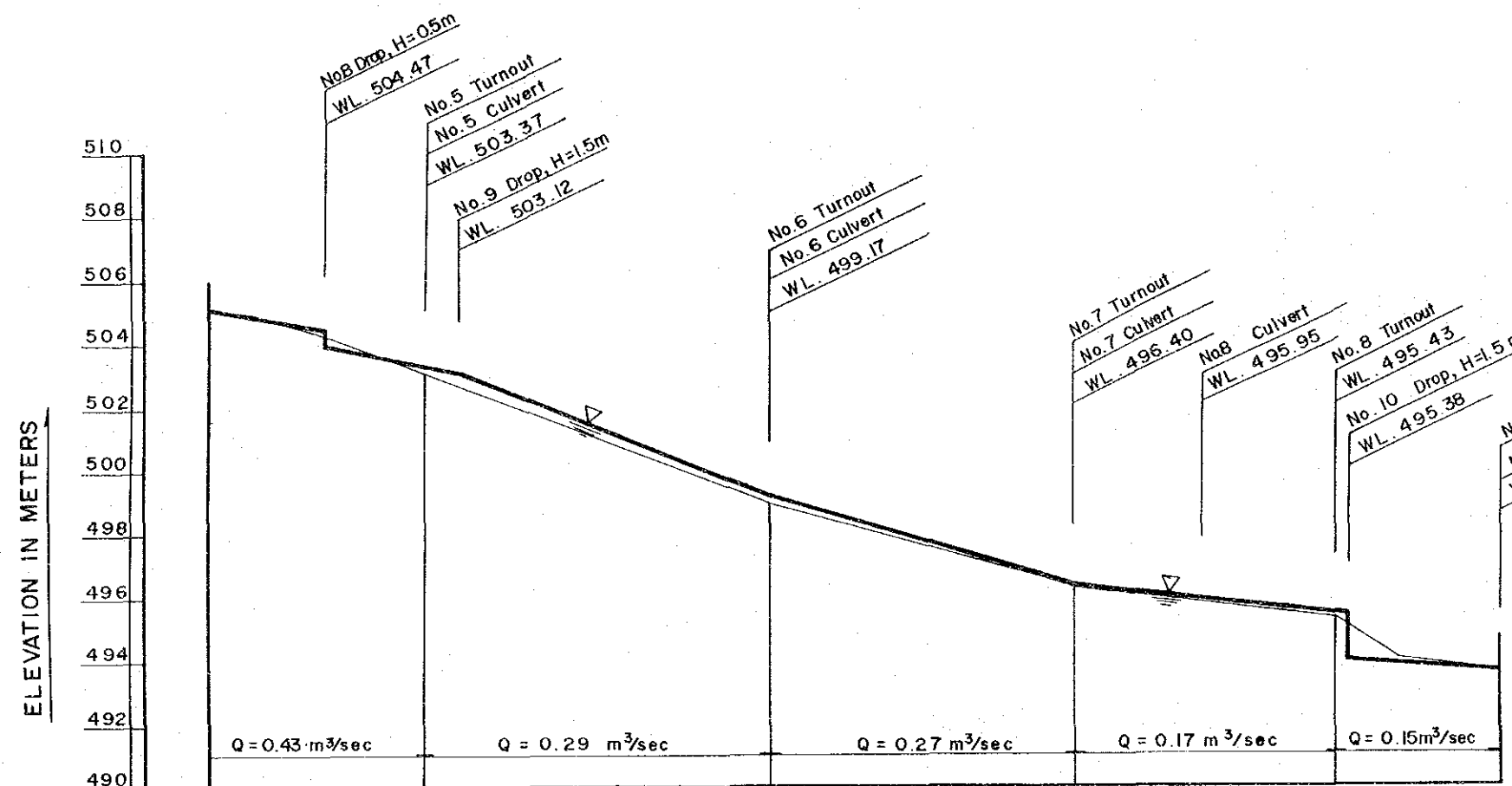

TYPICAL CROSS SECTION OF MAIN IRRIGATION CANAL

CANAL TYPE	C2		C3									
CANAL SLOPE	1/400	1/250	1/200		1/170		1/450		1/1,000			
GROUND SURFACE ELEVATION	505.1	504.0	502.6	501.0	499.6	498.1	497.0	496.2	495.6	494.5	493.6	
REDUCED DISTANCE	3.000	3.180 3.200	3.330 3.380 3.400	3.600	3.800 3.860	4.000	4.200	4.330 4.400	4.530 4.600	4.740 4.760	4.800	5.000

TYPE	H1	H2	B	m	W
A	1000	300	500-800	1:1.25	1000
B	850	300	400-800	1:1.25	1000
C1	750	200	300-600	1:1	500
C2	600	200	300-600	1:1	500
C3	500	200	300-600	1:1	500

DIMENSION TABLE

THE UNITED REPUBLIC OF TANZANIA
 KILIMANJARO REGION
 THE MKOMAZI VALLEY AREA IRRIGATION DEVELOPMENT PROJECT
 TITLE OF DRAWING
 PROFILE OF SASENI RIGHT MAIN CANAL (2/2)
 - KIHURIO SCHEME -
 JAPAN INTERNATIONAL COOPERATION AGENCY
 TOKYO

DWG. NO.
 4-9

ELEVATION IN METERS
526
524
522
520
518
516
514

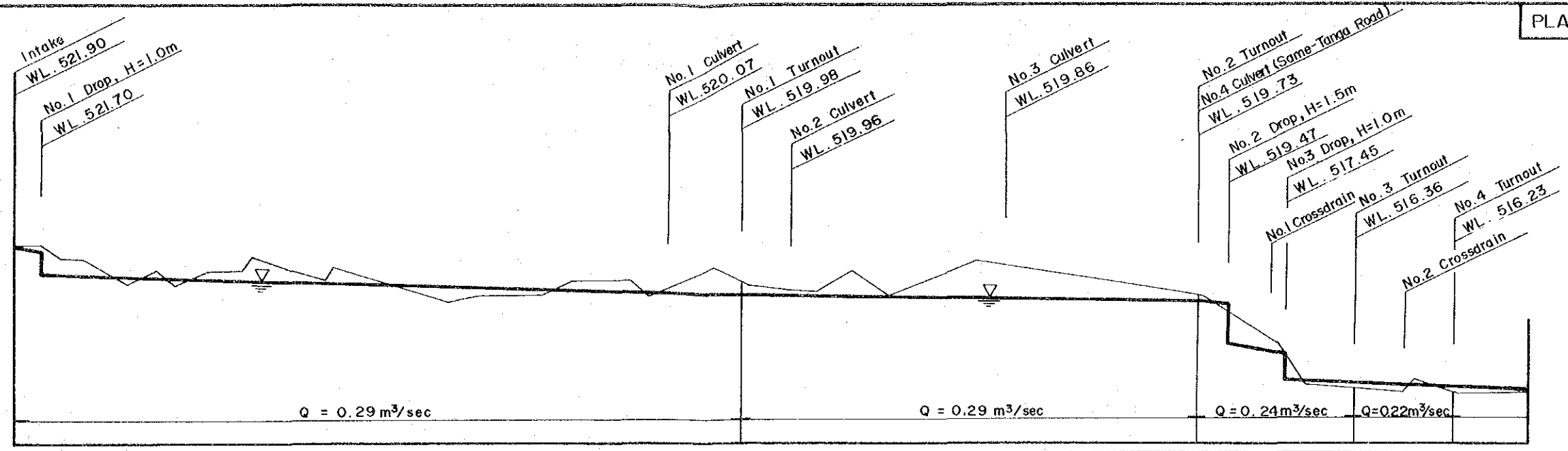

CANAL TYPE	C3		C2				C1				C3		C2		C3												
CANAL SLOPE	1/250		1/1,700				1/5,000				1/250		1/1,600														
GROUND SURFACE ELEVATION	522.0	520.7	521.0	520.7	520.1	520.0	520.6	521.0	520.2	520.5	521.0	520.4	519.2	516.2	516.4	516.0											
REDUCED DISTANCE	0	50	200	400	600	800	1,000	1,200	1,290	1,400	1,440	1,540	1,600	1,800	1,960	2,000	2,200	2,340	2,400	2,490	2,520	2,600	2,650	2,750	2,800	2,850	3,000

ELEVATION IN METERS
524
522
520
518
516
514
512

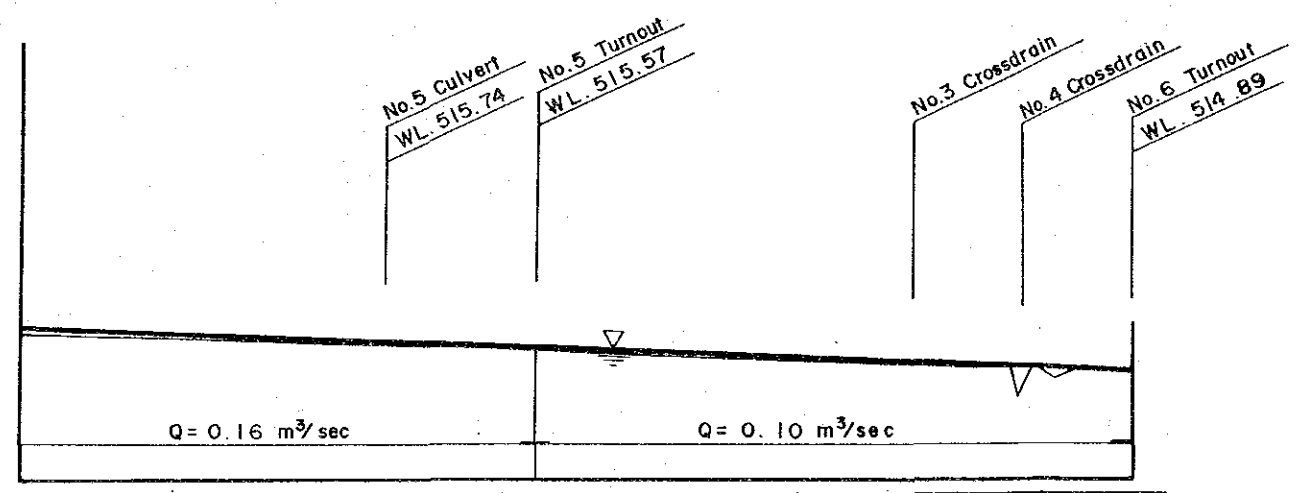

CANAL TYPE	C3												
CANAL SLOPE	1/1,200												
GROUND SURFACE ELEVATION	516.0	515.9	515.8	515.6	515.5	515.4	515.2	514.8	514.9				
REDUCED DISTANCE	3,000	3,070	3,200	3,400	3,490	3,600	3,690	3,800	4,000	4,200	4,350	4,400	4,500

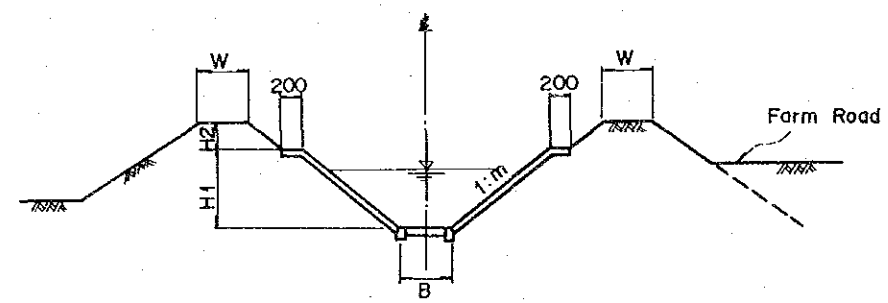

TYPICAL CROSS SECTION OF MAIN IRRIGATION CANAL

TYPE	H1	H2	B	m	W
A	1000	300	500~800	1:1.25	1000
B	850	300	400~800	1:1.25	1000
C1	750	200	300~600	1:1	500
C2	600	200	300~600	1:1	500
C3	500	200	300~600	1:1	500

DIMENSION TABLE

THE UNITED REPUBLIC OF TANZANIA
KILIMANJARO REGION
THE MKOMAZI VALLEY AREA IRRIGATION DEVELOPMENT PROJECT
TITLE OF DRAWING
PROFILE OF SASANI LEFT MAIN CANAL
- KIHURIO SCHEME -
JAPAN INTERNATIONAL COOPERATION AGENCY DWG. NO.
TOKYO 4-10

ELEVATION IN METERS

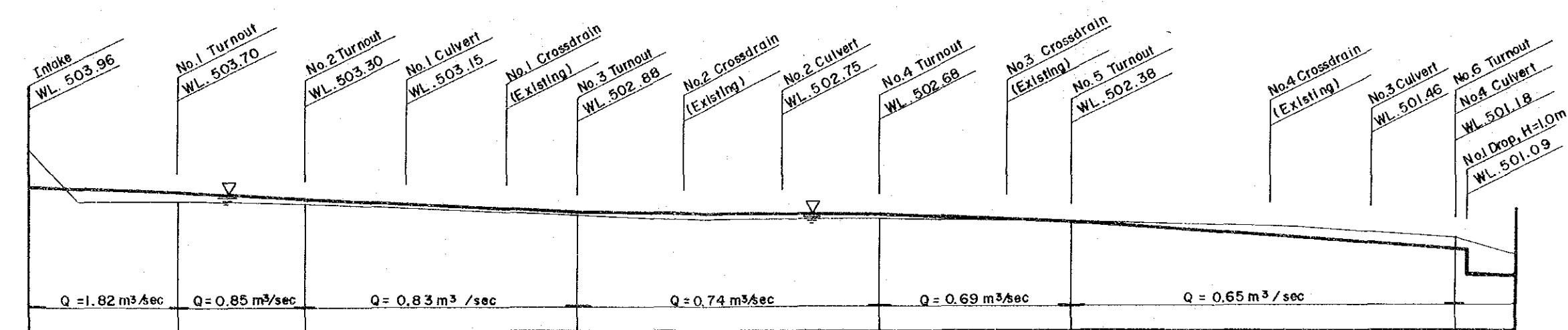

CANAL TYPE	A	C 1	B		C 1		B																									
CANAL SLOPE	1/2,000	1/650	1/1,300	1/3,200	1/1,300	1/650	1/3,000																									
GROUND SURFACE ELEVATION	505.4	503.3	503.2	503.1	503.0	502.8	502.6	502.6	502.6	502.5	502.4	502.3	502.2	502.1	501.8	501.4																
REDUCED DISTANCE	0	30	200	300	400	560	600	760	800	960	1,000	1,100	1,200	1,320	1,400	1,520	1,600	1,720	1,800	1,970	2,000	2,100	2,200	2,400	2,500	2,600	2,700	2,800	2,880	2,900	2,970	3,000

ELEVATION IN METERS

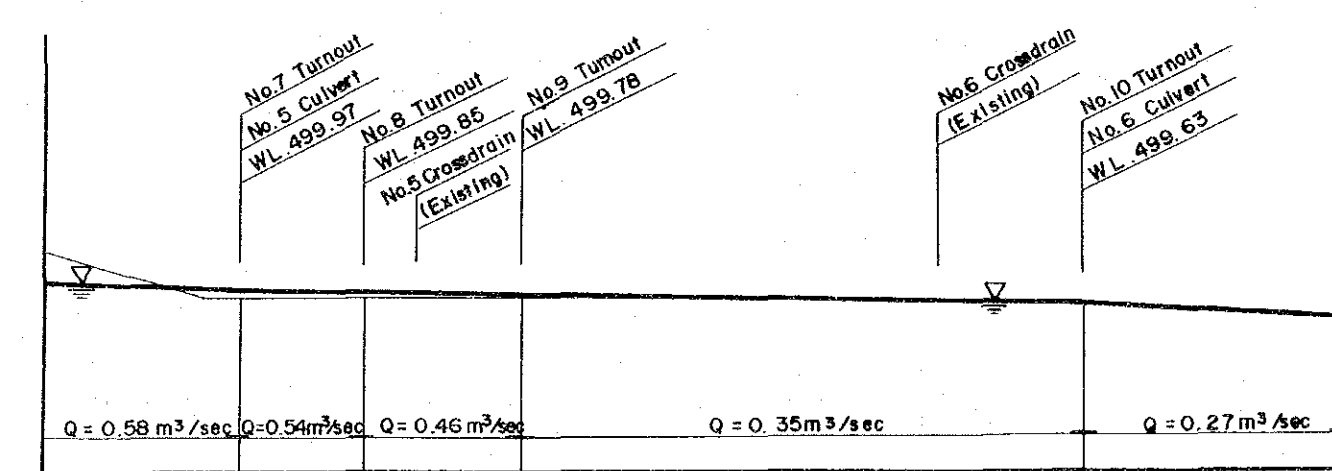

CANAL TYPE	B		C 1		C 3									
CANAL SLOPE	1/3,000		1/5,400		1/730									
GROUND SURFACE ELEVATION	500.4	499.9	499.8	499.8	499.7	499.6	499.6	499.6	499.3	499.1				
REDUCED DISTANCE	3,000	3,200	3,260	3,400	3,430	3,500	3,600	3,640	3,800	4,000	4,200	4,400	4,600	4,760

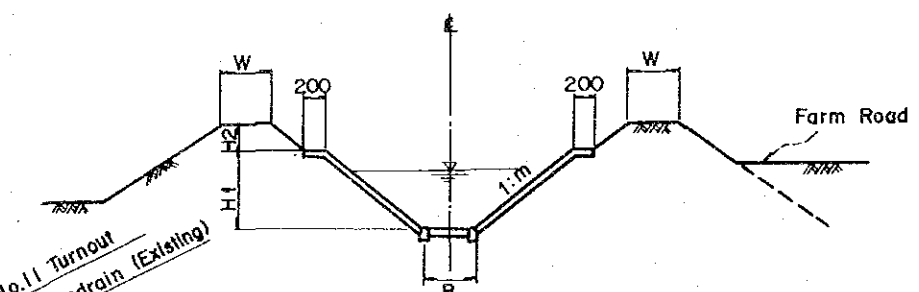

TYPICAL CROSS SECTION OF MAIN IRRIGATION CANAL

TYPE	H1	H2	B	m	W
A	1000	300	500-800	1:1.25	1000
B	850	300	400-800	1:1.25	1000
C 1	750	200	300-600	1:1	500
C 2	600	200	300-600	1:1	500
C 3	500	200	300-600	1:1	500

DIMENSION TABLE

THE UNITED REPUBLIC OF TANZANIA
 KILIMANJARO REGION
 THE MKOMAZI VALLEY AREA IRRIGATION DEVELOPMENT PROJECT
 TITLE OF DRAWING
 PROFILE OF KALIMAWA LEFT MAIN CANAL
 - KIHURIO SCHEME -
 JAPAN INTERNATIONAL COOPERATION AGENCY DWG. NO.
 TOKYO 4-11

ELEVATION IN METERS

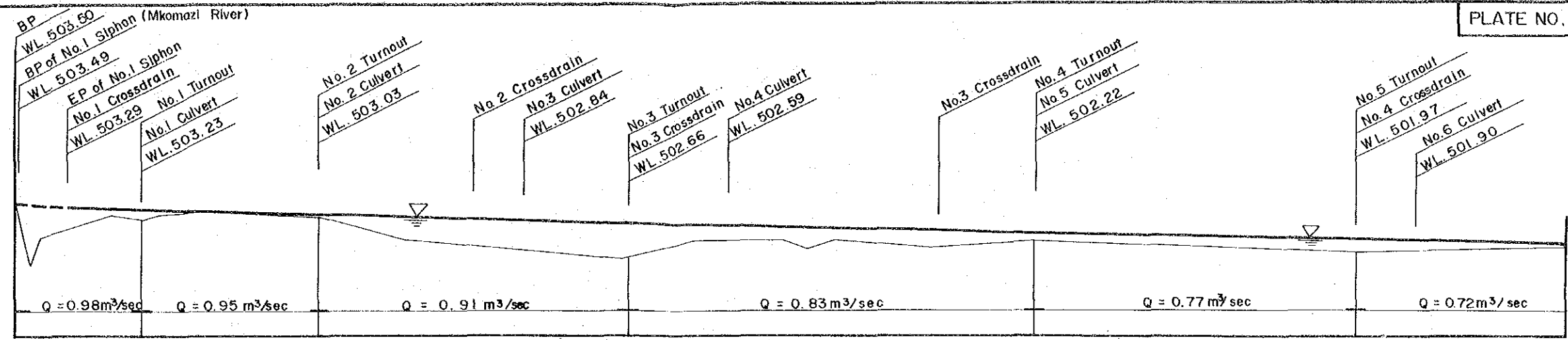

CANAL TYPE
CANAL SLOPE
GROUND SURFACE ELEVATION
REDUCED DISTANCE

A	A																											
1/2000	1/2,800				1/3,000										1/8,500													
503.5	503.0	503.2	503.0	502.0	501.6	501.3	502.0	501.9	501.8	501.8	501.9	501.7	501.6	501.5	501.6													
0	110	200	260	400	600	620	800	940	1,000	1,040	1,200	1,260	1,400	1,470	1,600	1,800	1,900	2,000	2,100	2,200	2,400	2,600	2,760	2,800	2,880	3,000	3,110	3,200

ELEVATION IN METERS

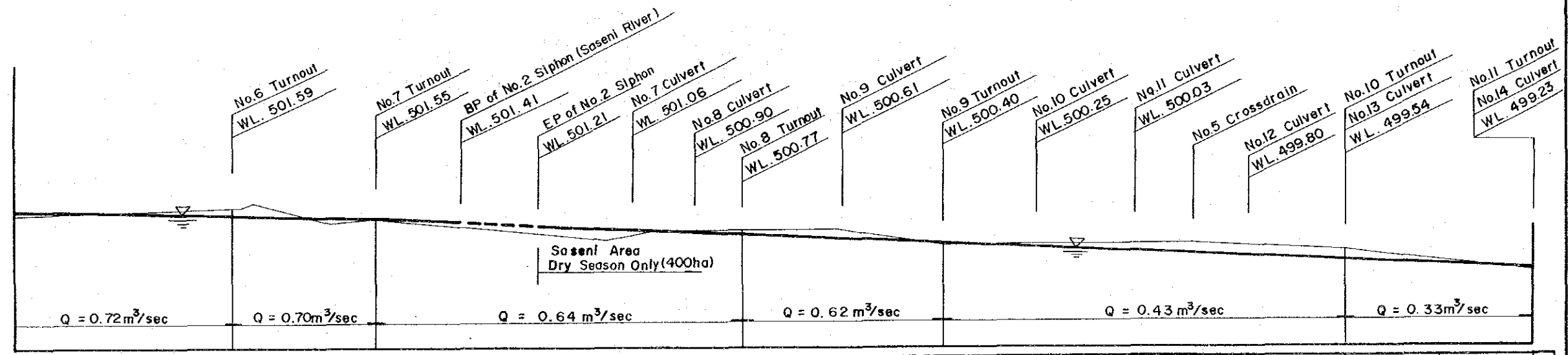

CANAL TYPE
CANAL SLOPE
GROUND SURFACE ELEVATION
REDUCED DISTANCE

	A				C1	C1										C2												
	1/8,500				1/1,300	1/1,300																						
501.7	501.8	501.9	501.7	501.5	501.1	500.7	501.0	501.0	500.8	500.3	500.3	500.3	500.3	500.2	500.0	499.6	499.1											
3,200	3,400	3,600	3,660	3,800	3,960	4,000	4,140	4,200	4,300	4,400	4,500	4,600	4,640	4,740	4,800	4,950	5,000	5,160	5,200	5,340	5,400	5,560	5,600	5,680	5,800	6,000	6,200	6,400

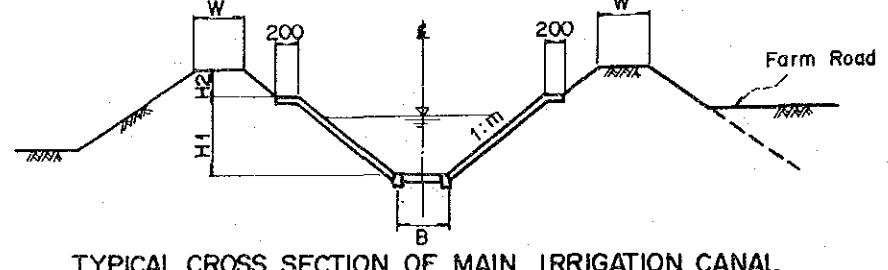

TYPICAL CROSS SECTION OF MAIN IRRIGATION CANAL

TYPE	H1	H2	B	m	W
A	1000	300	500~800	1:1.25	1000
B	850	300	400~800	1:1.25	1000
C1	750	200	300~600	1:1	500
C2	600	200	300~600	1:1	500
C3	500	200	300~600	1:1	500

DIMENSION TABLE

THE UNITED REPUBLIC OF TANZANIA
 KILIMANJARO REGION
 THE MKOMAZI VALLEY AREA IRRIGATION DEVELOPMENT PROJECT
 TITLE OF DRAWING
 PROFILE OF KALIMAWA RIGHT MAIN CANAL
 - KIHURIO SCHEME -
 JAPAN INTERNATIONAL COOPERATION AGENCY DWG. NO.
 TOKYO 4-12

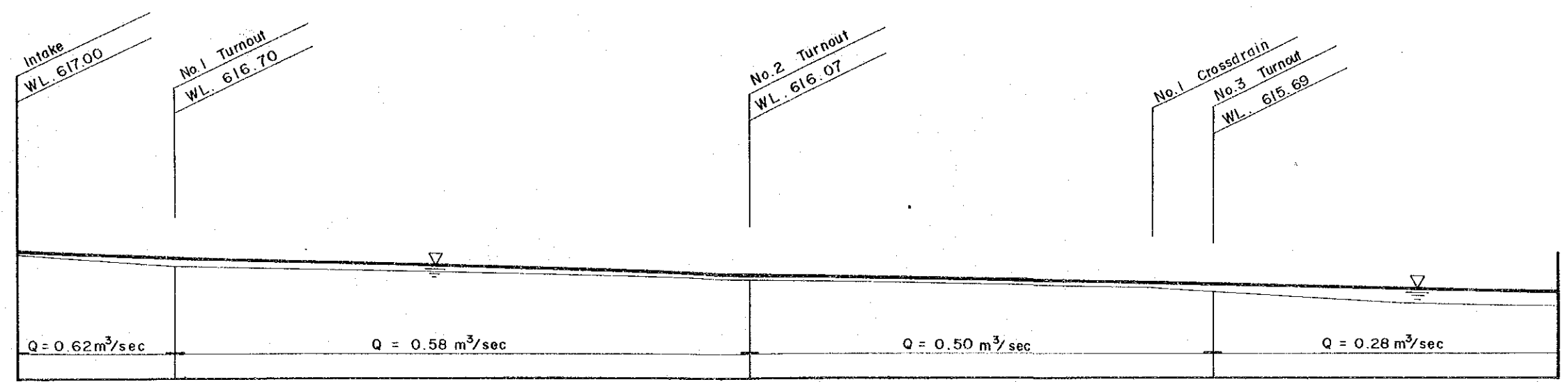
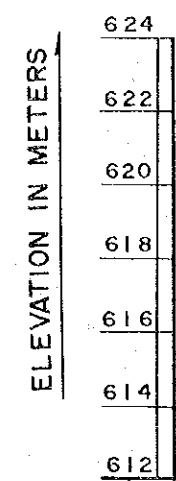

CANAL TYPE	C1															
CANAL SLOPE	1/1,000		1/1,800						1/2,400							
GROUND SURFACE ELEVATION	616.8	616.6	616.4	616.3	616.2	616.1	616.0	615.9	615.8	615.7	615.6	615.6	615.4	615.1	614.9	614.8
REDUCED DISTANCE	0	200	300	400	600	800	1,000	1,200	1,400	1,600	1,800	2,000	2,200	2,320	2,400	3,000

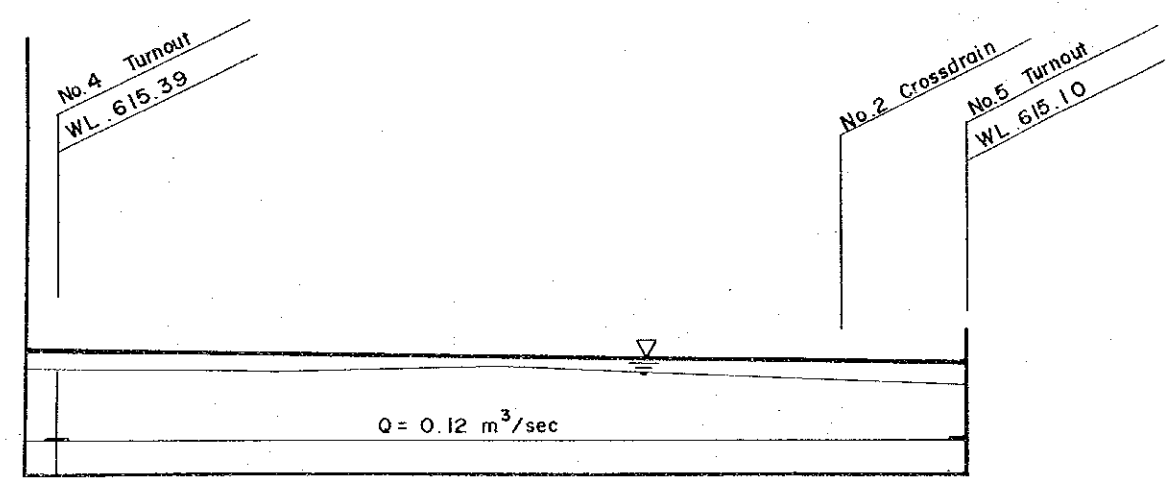
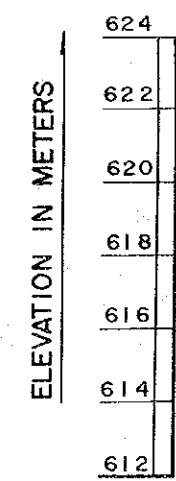

CANAL TYPE	C2						
CANAL SLOPE	1/4,000						
GROUND SURFACE ELEVATION	614.8	614.9	614.8	615.0	614.8	614.7	614.5
REDUCED DISTANCE	3,000	3,040	3,200	3,400	3,600	3,800	4,270

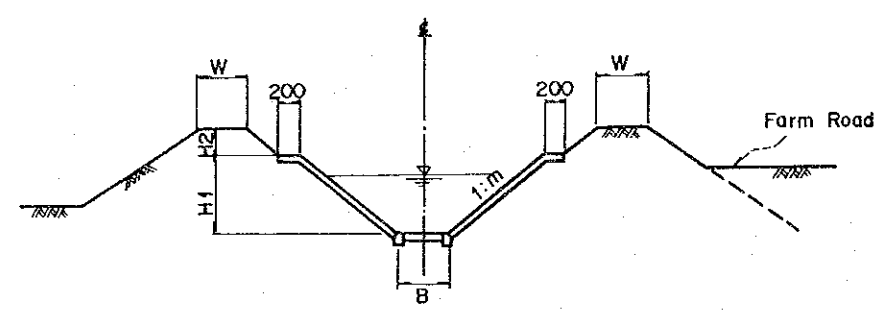

TYPICAL CROSS SECTION OF MAIN IRRIGATION CANAL

TYPE	H1	H2	B	m	W
A	1000	300	500~800	1:1.25	1000
B	850	300	400~800	1:1.25	1000
C1	750	200	300~600	1:1	500
C2	600	200	300~600	1:1	500
C3	500	200	300~600	1:1	500

DIMENSION TABLE

THE UNITED REPUBLIC OF TANZANIA
 KILIMANJARO REGION
 THE MKOMAZI VALLEY AREA IRRIGATION DEVELOPMENT PROJECT
 TITLE OF DRAWING
 PROFILE OF IGOMA RIGHT MAIN CANAL
 - IGOMA SCHEME -
 JAPAN INTERNATIONAL COOPERATION AGENCY TOKYO DWG. NO.
 4-13

ELEVATION IN METERS

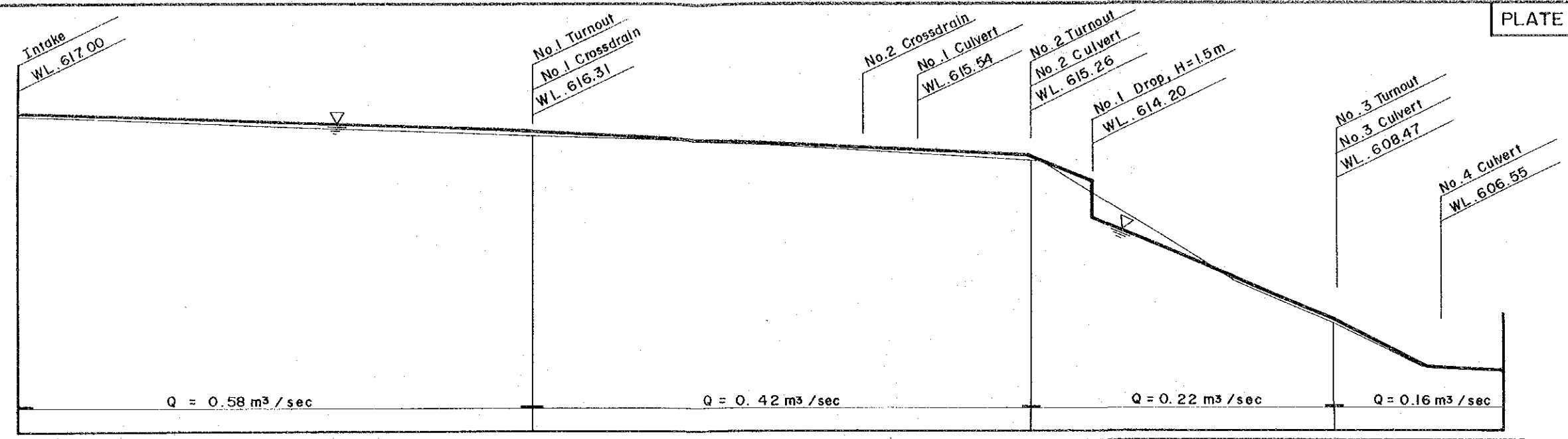
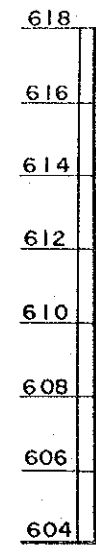

CANAL TYPE
CANAL SLOPE
GROUND SURFACE ELEVATION
REDUCED DISTANCE

	C 1										C 3												
CANAL SLOPE	1 / 1,500					1 / 1,000					1 / 120		1 / 100	1 / 1200									
GROUND SURFACE ELEVATION	616.9	616.8	616.6	616.5	616.4	616.2	616.1	615.9	615.6	615.4	615.2	613.2	610.6	608.8	606.8	606.4							
REDUCED DISTANCE	0	200	400	600	800	1,000	1,030	1,200	1,400	1,600	1,690	1,800	2,000	2,040	2,150	2,200	2,400	2,600	2,650	2,800	2,840	2,860	3,000

ELEVATION IN METERS

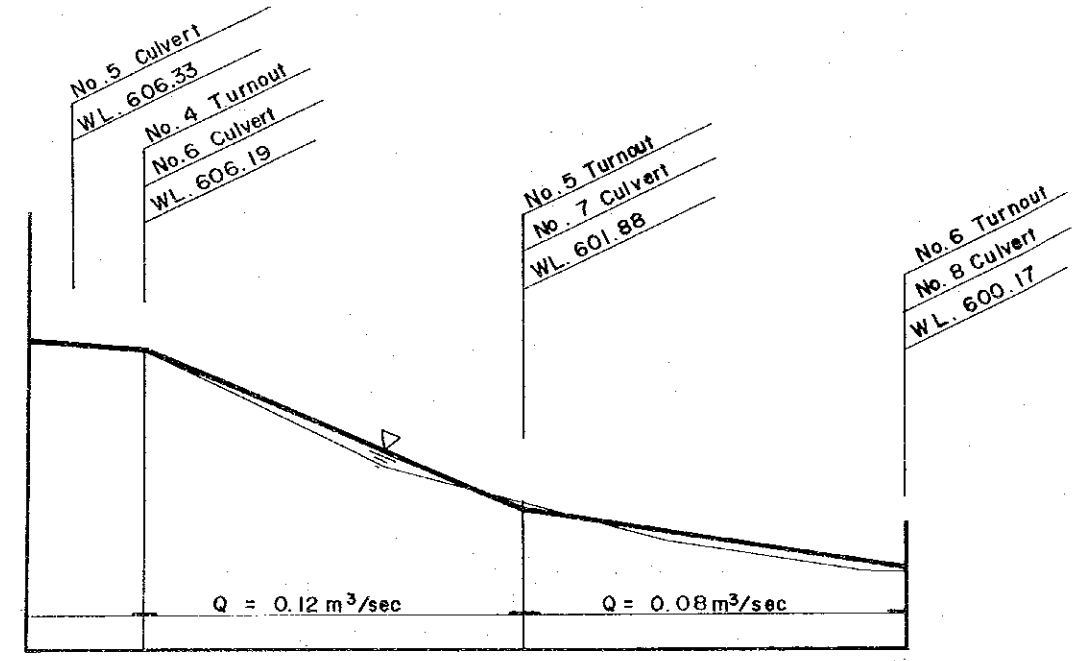
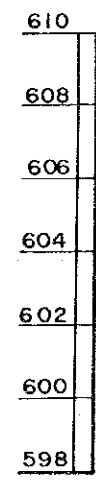

CANAL TYPE
CANAL SLOPE
GROUND SURFACE ELEVATION
REDUCED DISTANCE

	C 3																			
CANAL SLOPE	1 / 1,200	1 / 120				1 / 310														
GROUND SURFACE ELEVATION	606.4	605.8	603.8	602.3	601.2	600.6	600.1	606.4	605.8	603.8	602.3	601.2	600.6	600.1						
REDUCED DISTANCE	3,000	3,060	3,160	3,200	3,400	3,600	3,660	3,800	4,000	4,170	3,000	3,060	3,160	3,200	3,400	3,600	3,660	3,800	4,000	4,170

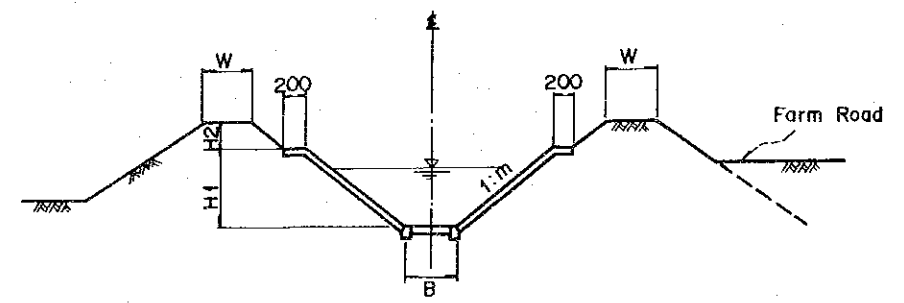

TYPICAL CROSS SECTION OF MAIN IRRIGATION CANAL

TYPE	H1	H2	B	m	W
A	1000	300	500~800	1:1.25	1000
B	850	300	400~800	1:1.25	1000
C 1	750	200	300~600	1:1	500
C 2	600	200	300~600	1:1	500
C 3	500	200	300~600	1:1	500

DIMENSION TABLE

THE UNITED REPUBLIC OF TANZANIA
 KILIMANJARO REGION
 THE MKOMAZI VALLEY AREA IRRIGATION DEVELOPMENT PROJECT
 TITLE OF DRAWING
 PROFILE OF IGOMA LEFT MAIN CANAL
 - IGOMA SCHEME -
 JAPAN INTERNATIONAL COOPERATION AGENCY DWG. NO.
 TOKYO 4-14

PLAN

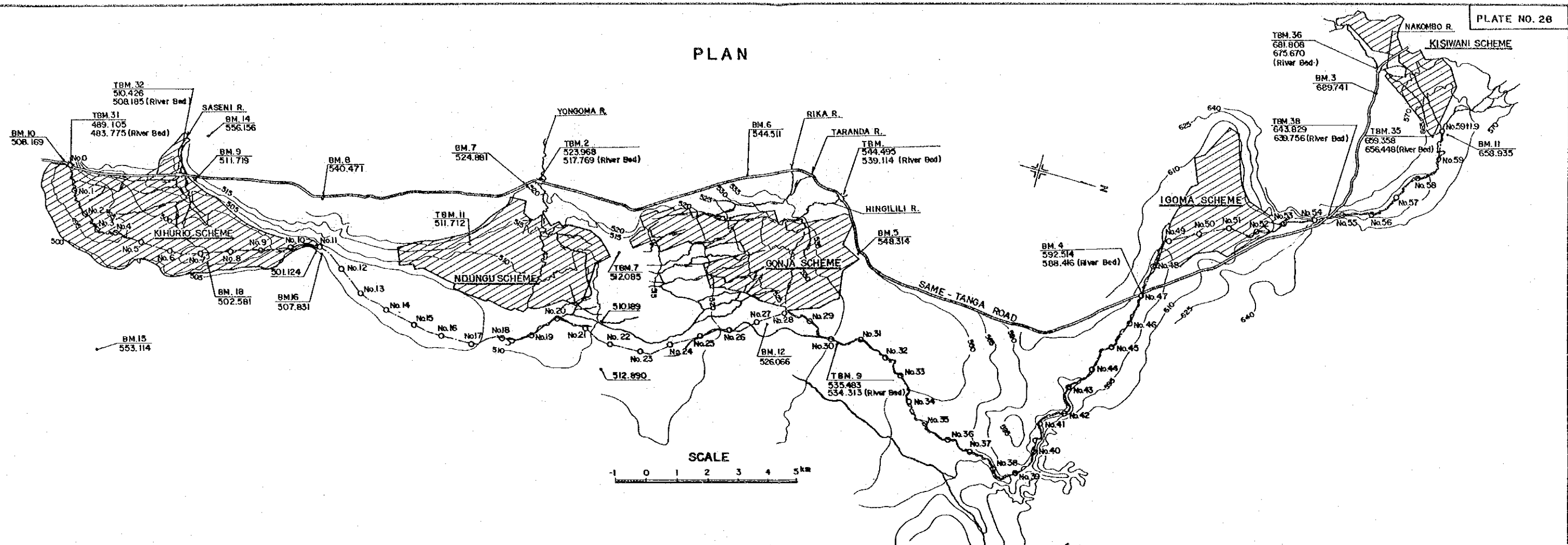

SCALE

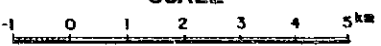

PROFILE

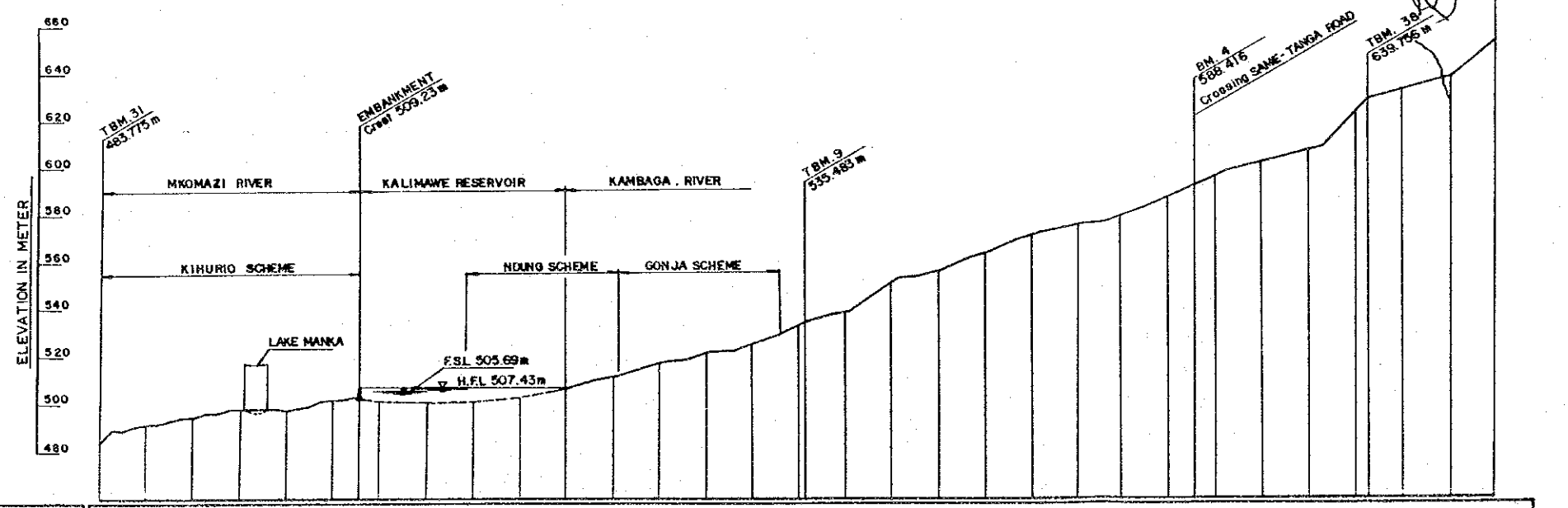

SCALE



CANAL BASE ELEVATION																																			
WATER SURFACE ELEVATION																																			
GROUND SURFACE ELEVATION	483.75	491.0	494.0	497.0	497.0	502.0	509.23																												
REDUCED DISTANCE (IN KM)	0.0	2.0	4.0	6.0	8.0	10.0	11.0	12.0	14.0	16.0	18.0	20.0	22.0	24.0	26.0	28.0	30.0	30.5	32.0	34.0	36.0	38.0	40.0	42.0	44.0	46.0	48.0	50.0	52.0	54.0	54.5	56.0	58.0	59.9	
DISTANCE (IN KM)	0.0	2.0	2.0	2.0	2.0	2.0	1.1	0.9	2.0	2.0	2.0	2.0	2.0	2.0	2.0	2.0	2.0	0.5	1.7	2.0	2.0	2.0	2.0	2.0	2.0	2.0	2.0	2.0	2.0	2.0	2.0	2.0	2.0	1.9	
STATION	No.0	No.2	No.4	No.6	No.8	No.10	No.11	No.12	No.14	No.16	No.18	No.20	No.22	No.24	No.26	No.28	No.30	No.31	No.32	No.34	No.36	No.38	No.40	No.42	No.44	No.46	No.47	No.48	No.50	No.52	No.54	No.55	No.56	No.58	No.59

THE UNITED REPUBLIC OF TANZANIA
 KILIMANJARO REGION
 THE MKOMAZI VALLEY AREA IRRIGATION DEVELOPMENT PROJECT

TITLE OF DRAWING
PROFILE OF RIVERS

JAPAN INTERNATIONAL COOPERATION AGENCY
 TOKYO

DWG. NO.
 5 - 1

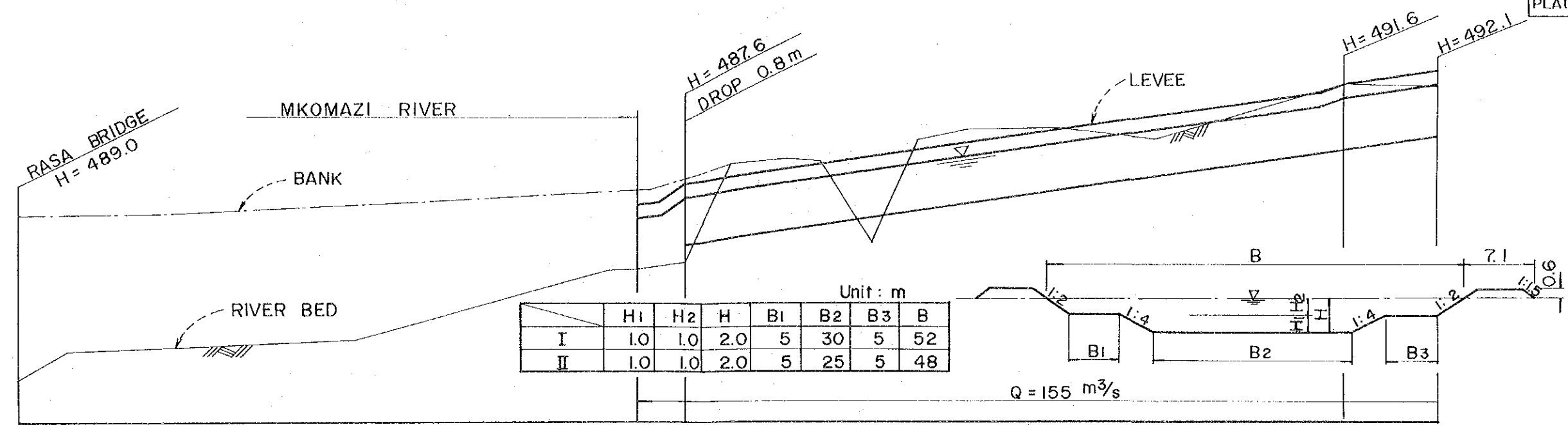
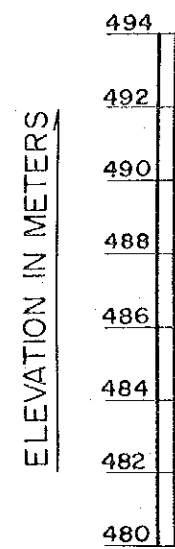

Unit : m

	H1	H2	H	B1	B2	B3	B
I	1.0	1.0	2.0	5	30	5	52
II	1.0	1.0	2.0	5	25	5	48

CANAL TYPE	I
CANAL SLOPE	1/350
GROUND SURFACE ELEVATION	481.8 483.0 483.1 483.2 483.4 483.5 484.1 485.2 486.3 486.8 491.2 487.6 492.4 492.5 492.0 493.2 494.3 494.2
REDUCED DISTANCE	0 100 200 400 600 700 800 1000 1200 1400 1600 1800 2000 2200 2400 2600 2800 3000

I	
1/350	
481.8 483.0 483.1 483.2 483.4 483.5 484.1 485.2 486.3 486.8 491.2 487.6 492.4 492.5 492.0 493.2 494.3 494.2	
0 100 200 400 600 700 800 1000 1200 1400 1600 1800 2000 2200 2400 2600 2800 3000	

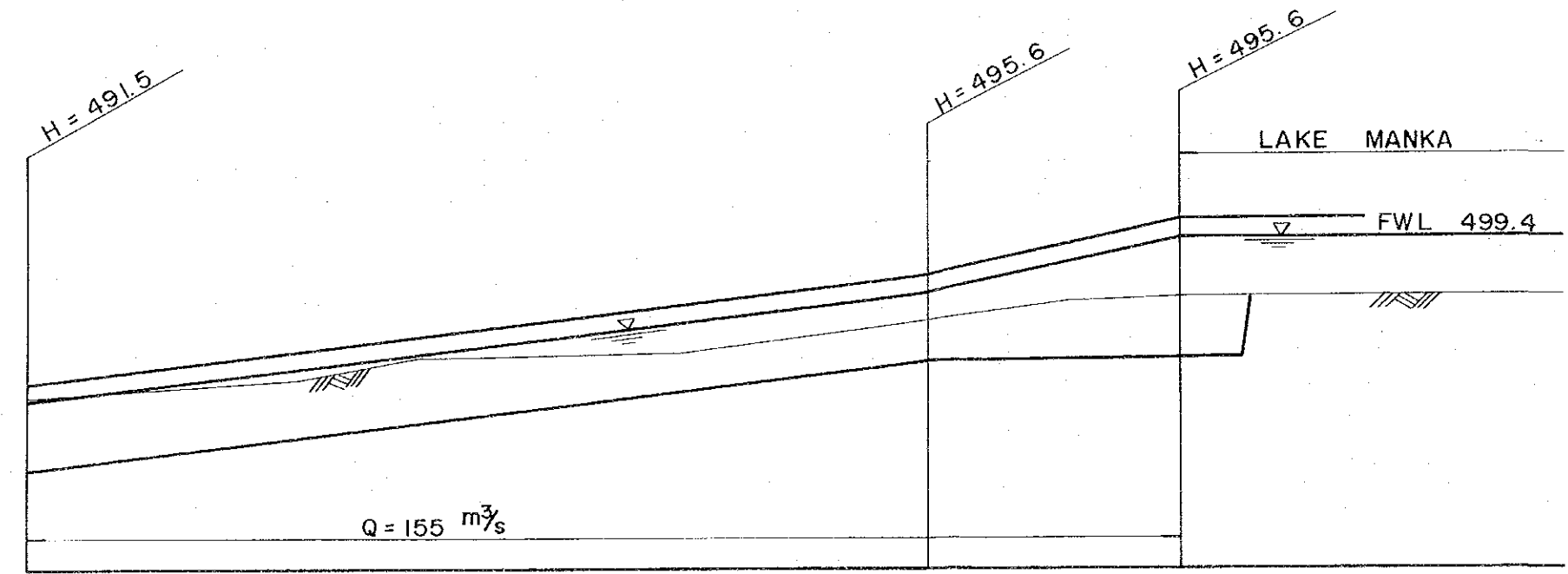
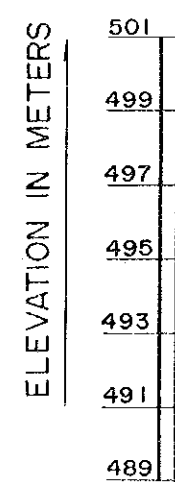

CANAL TYPE	II
CANAL SLOPE	1/400
GROUND SURFACE ELEVATION	494.2 494.7 494.9 495.6 495.8 495.8 496.3 496.9 497.4 497.6 497.6 497.6 497.6
REDUCED DISTANCE	3000 3200 3400 3600 3800 4000 4200 4400 4600 4800 5000 5200 5400

II	
1/400	
494.2 494.7 494.9 495.6 495.8 495.8 496.3 496.9 497.4 497.6 497.6 497.6 497.6	
3000 3200 3400 3600 3800 4000 4200 4400 4600 4800 5000 5200 5400	

THE UNITED REPUBLIC OF TANZANIA
 KILIMANJARO REGION
 THE MKOMAZI VALLEY AREA IRRIGATION DEVELOPMENT PROJECT

TITLE OF DRAWING
 PROFILE OF MKOMAZI RIVER (1/2)
 - KIHURIO SCHEME -

JAPAN INTERNATIONAL COOPERATION AGENCY
 TOKYO

DWG. NO.
 5-2

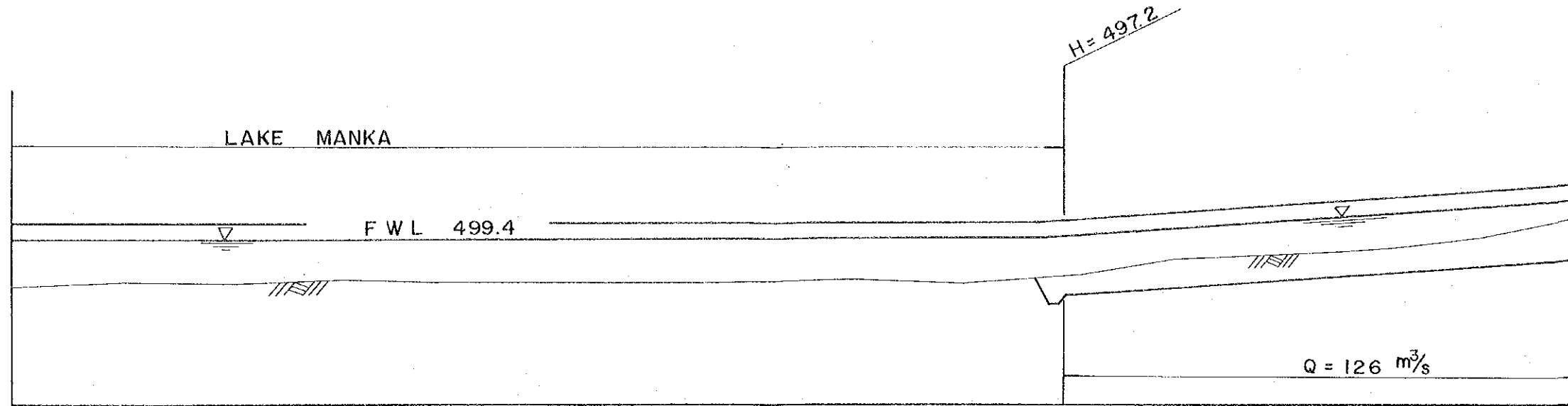
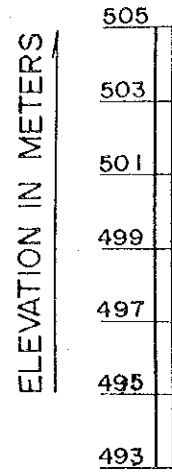

CANAL TYPE
CANAL SLOPE
GROUND SURFACE ELEVATION
REDUCED DISTANCE

I																
1/700																
497.6	497.7	497.6	497.7	497.6	497.6	497.6	497.6	497.6	497.7	497.7	497.9	498.5	498.7	498.9	499.4	500.2
5400	5600	5800	6000	6200	6400	6600	6800	7000	7200	7400	7600	7800	8000	8200	8400	

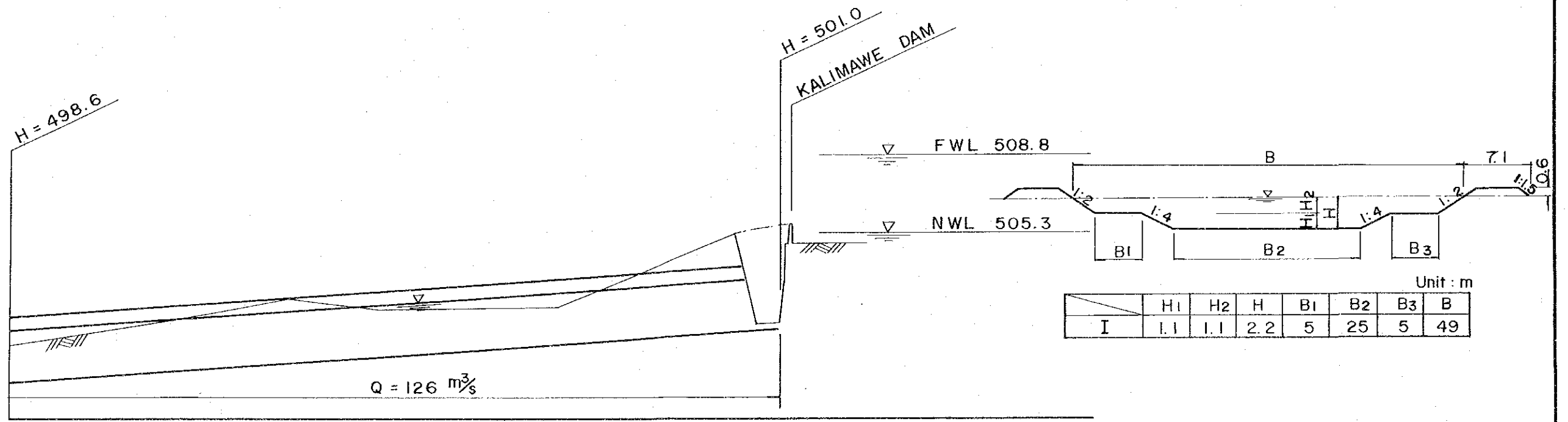
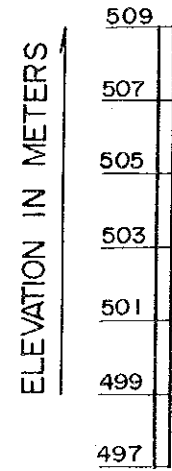

CANAL TYPE
CANAL SLOPE
GROUND SURFACE ELEVATION
REDUCED DISTANCE

I									
1/700									
500.2	500.8	501.4	502.2	501.8	501.8	501.9	503.5	505.2	
8400	8600	8800	9000	9200	9400	9600	9800	10000	

Unit : m

	H1	H2	H	B1	B2	B3	B
I	1.1	1.1	2.2	5	25	5	49

THE UNITED REPUBLIC OF TANZANIA
KILIMANJARO REGION
THE MKOMAZI VALLEY AREA IRRIGATION DEVELOPMENT PROJECT
TITLE OF DRAWING
PROFILE OF MKOMAZI RIVER (2 / 2)
- KIHURIO SCHEME -
JAPAN INTERNATIONAL COOPERATION AGENCY
TOKYO
DWG. NO.
5 - 3

ELEVATION IN METERS

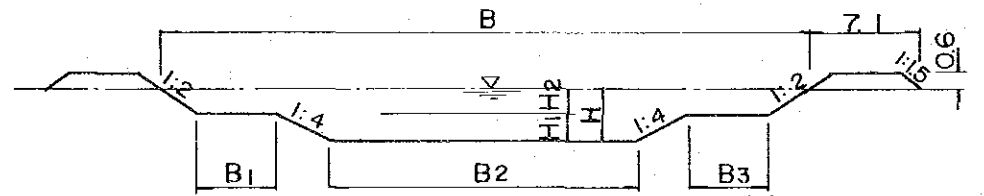
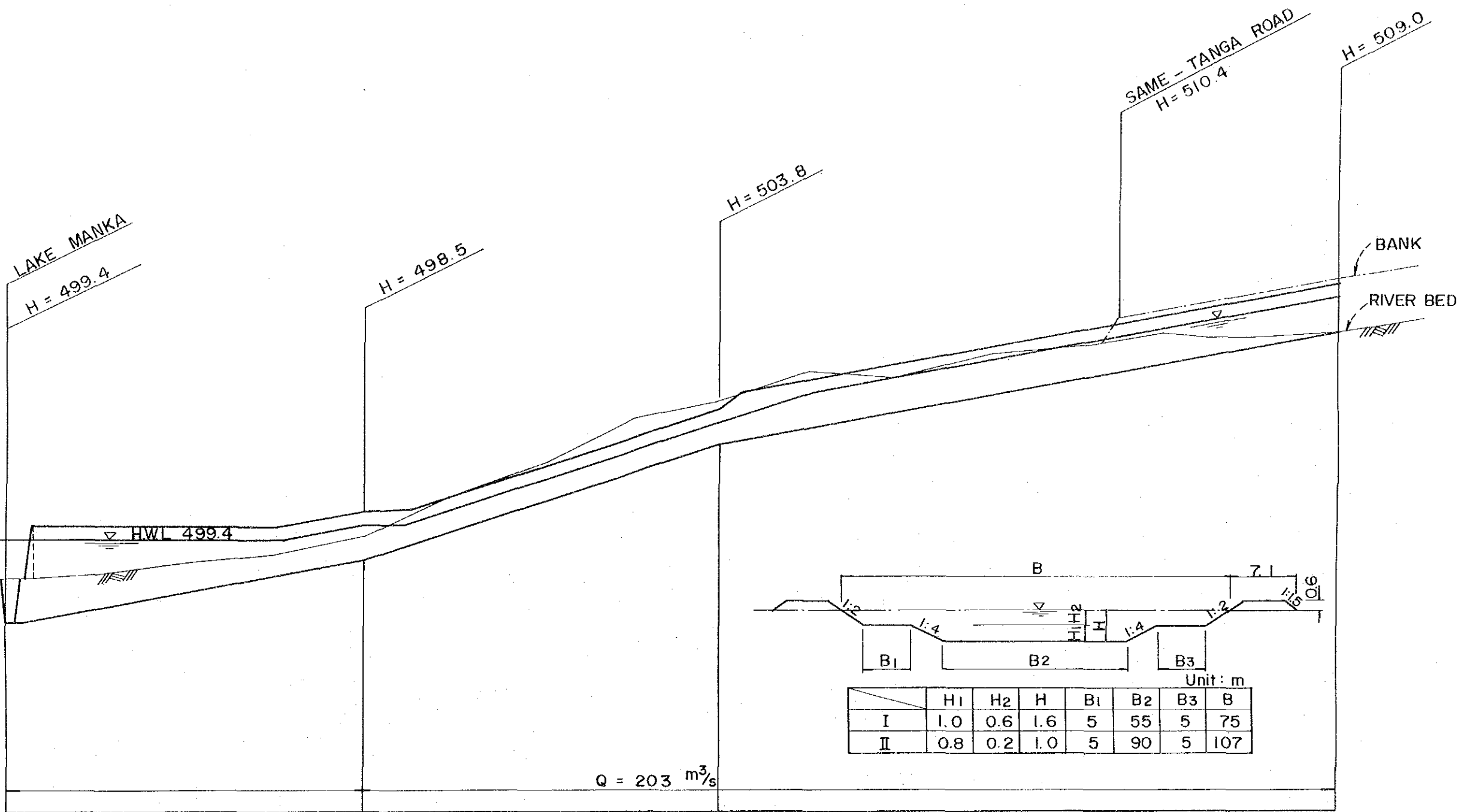
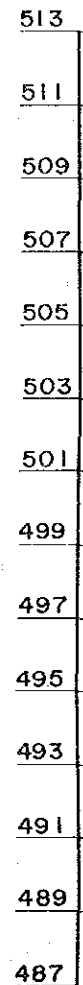

Unit : m

	H ₁	H ₂	H	B ₁	B ₂	B ₃	B
I	1.0	0.6	1.6	5	55	5	75
II	0.8	0.2	1.0	5	90	5	107

CANAL TYPE	I	II	I														
CANAL SLOPE	1/270	1/150	1/270														
GROUND SURFACE ELEVATION	497.6	497.8	498.3	498.7	499.6	501.4	502.8	504.8	505.7	507.1	506.8	507.9	508.3	508.6	508.7	508.7	509.0
REDUCED DISTANCE	0	200	400	600	800	1000	1200	1400	1600	1800	2000	2200	2400	2600	2700	2800	3000

THE UNITED REPUBLIC OF TANZANIA
 KILIMANJARO REGION
 THE MKOMAZI VALLEY AREA IRRIGATION DEVELOPMENT PROJECT
 TITLE OF DRAWING
 PROFILE OF SASANI FLOODWAY
 - KIHURIO SCHEME -
 JAPAN INTERNATIONAL COOPERATION AGENCY
 TOKYO
 DWG. NO.
 5-4

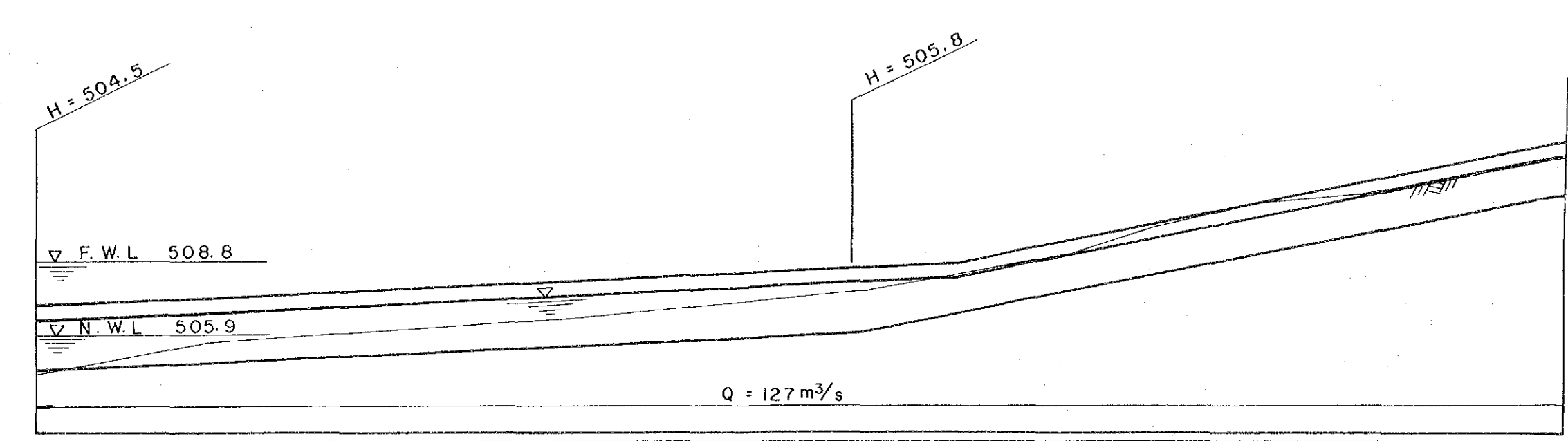
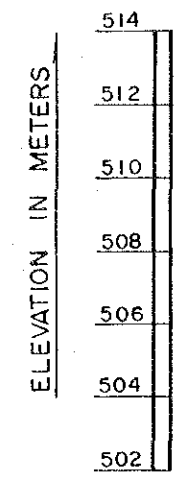

CANAL TYPE	
CANAL SLOPE	
GROUND SURFACE ELEVATION	
REDUCED DISTANCE	

	I										II								
	1/1200										1/250								
GROUND SURFACE ELEVATION	504.3	506.1	505.7	506.0	506.4	506.5	506.9	507.2	507.6	508.2	508.9	510.1	511.1	511.5	512.2	512.9			
REDUCED DISTANCE	0	200	400	600	800	1000	1200	1400	1600	1800	2000	2200	2400	2600	2800	3000			

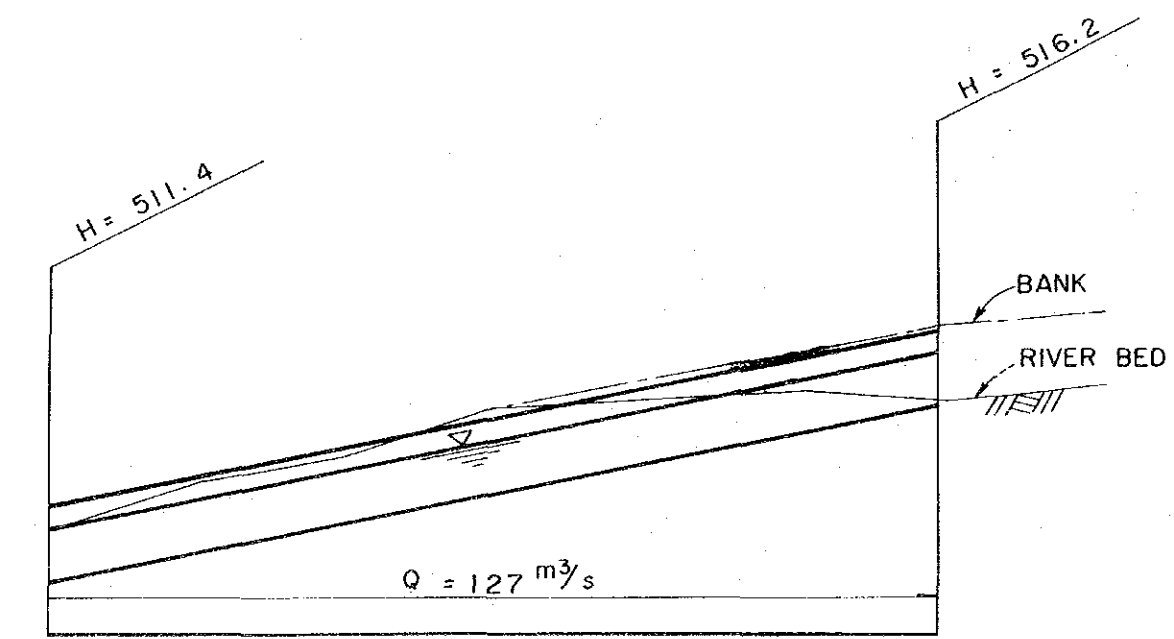
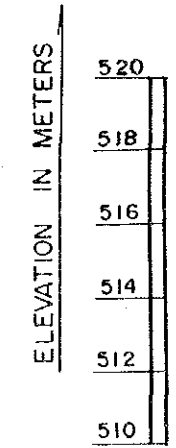

CANAL TYPE	
CANAL SLOPE	
GROUND SURFACE ELEVATION	
REDUCED DISTANCE	

	II						
	1/250						
GROUND SURFACE ELEVATION	514.2	514.8	516.1	516.3	516.5	516.3	516.2
REDUCED DISTANCE	3000	3200	3400	3600	3800	4000	4200

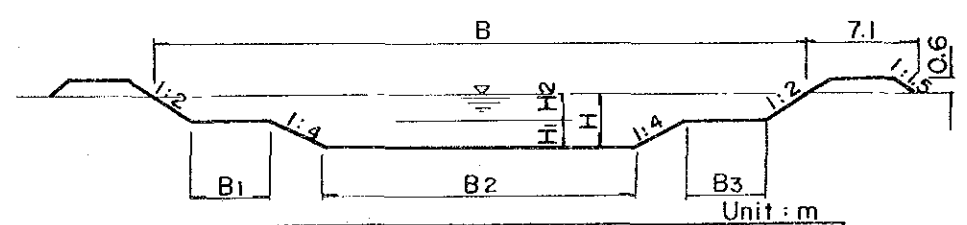

	H ₁	H ₂	H	B ₁	B ₂	B ₃	B
I	0.8	0.8	1.6	15	35	15	76
II	1.0	0.5	1.5	5	35	5	55

Unit: m

THE UNITED REPUBLIC OF TANZANIA
 KILIMANJARO REGION
 THE MKOMAZI VALLEY AREA IRRIGATION DEVELOPMENT PROJECT

TITLE OF DRAWING
 PROFILE OF YONGOMA FLOODWAY
 - NDUNGU SCHEME -

JAPAN INTERNATIONAL COOPERATION AGENCY TOKYO DWG. NO. 5-5

ELEVATION IN METERS

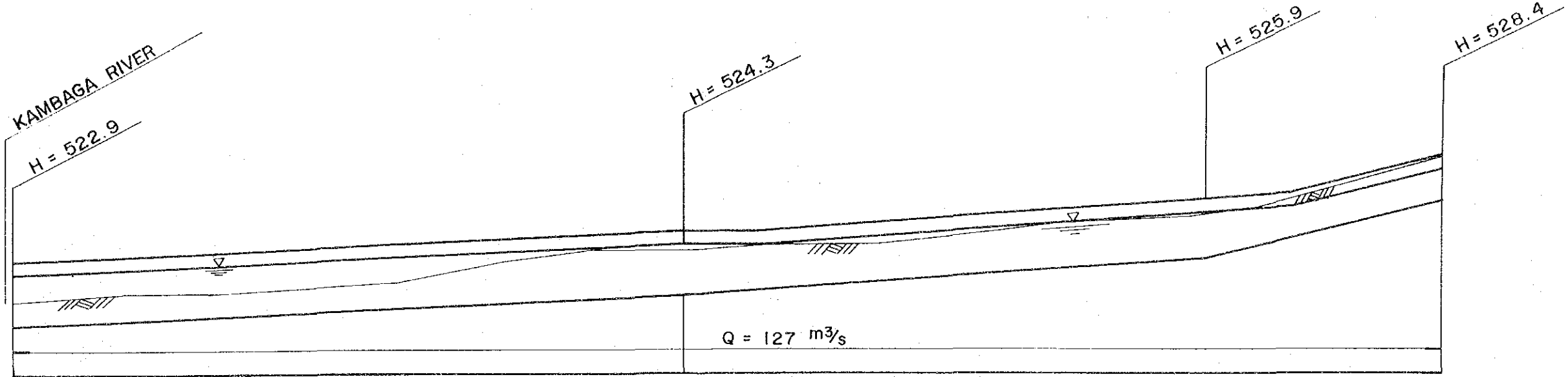
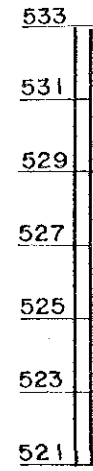

CANAL TYPE	
CANAL SLOPE	
GROUND SURFACE ELEVATION	
REDUCED DISTANCE	

	I							II						III		
	1/1000							1/700						1/200		
GROUND SURFACE ELEVATION	524.1	524.3	524.5	524.7	524.9	525.7	526.2	526.3	526.4	526.5	526.9	527.4	527.6	528.0	529.0	530.2
REDUCED DISTANCE	0	200	400	600	800	1000	1200	1400	1600	1800	2000	2200	2400	2600	2800	3000

ELEVATION IN METERS

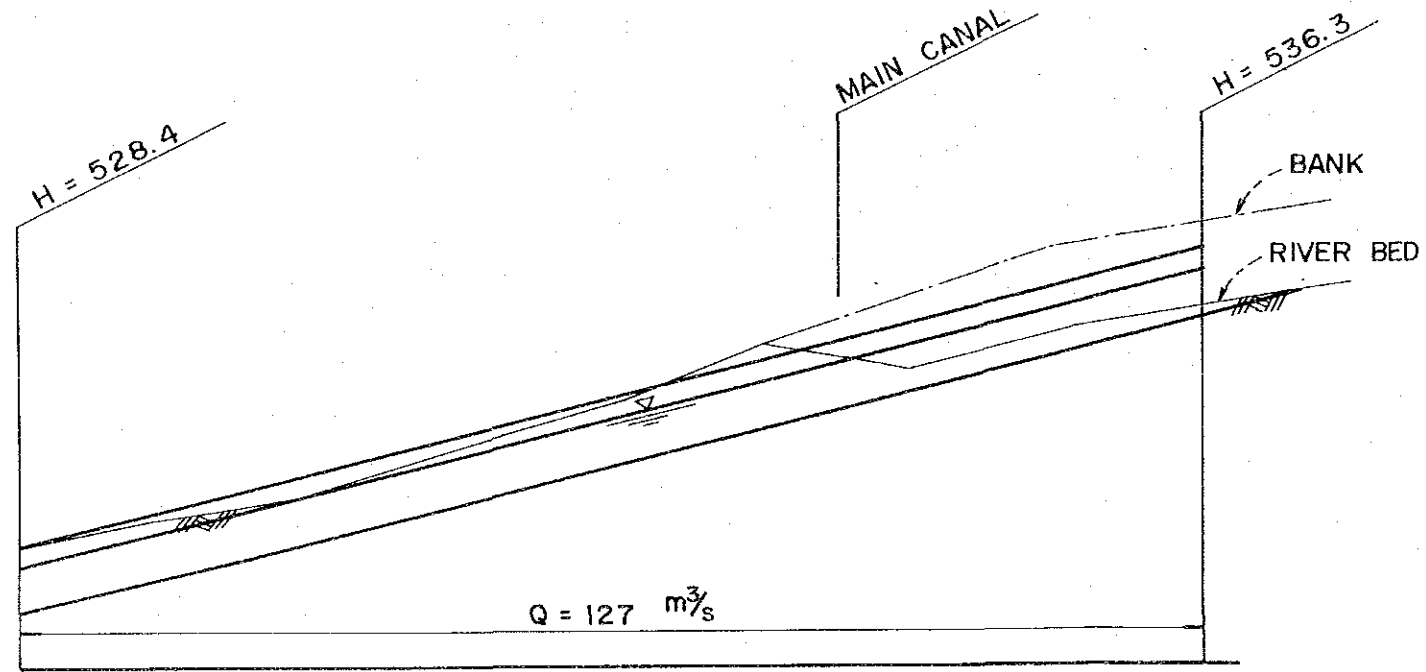
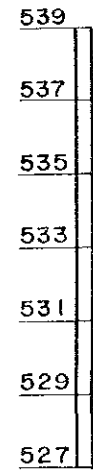

CANAL TYPE	
CANAL SLOPE	
GROUND SURFACE ELEVATION	
REDUCED DISTANCE	

	III								
	1/200								
GROUND SURFACE ELEVATION	530.2	531.0	531.6	533.0	534.2	535.1	535.0	536.0	536.7
REDUCED DISTANCE	3000	3200	3400	3600	3800	4000	4200	4400	4600

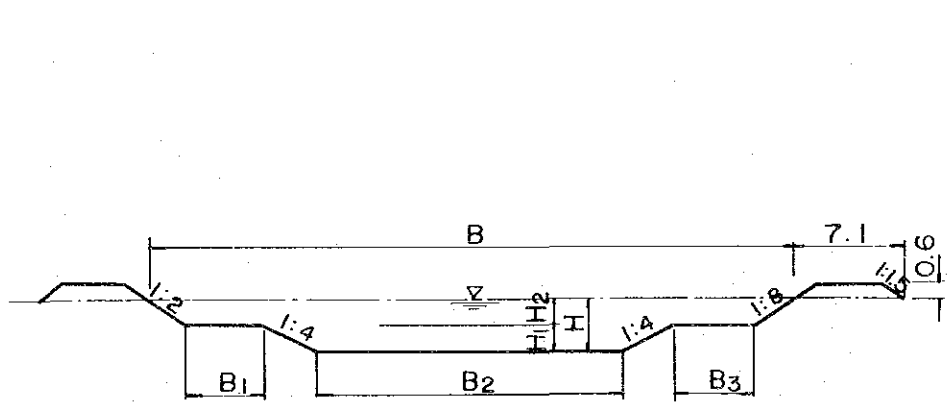

Unit: m

	H ₁	H ₂	H	B ₁	B ₂	B ₃	B
I	1.0	1.0	2.0	5	40	5	62
II	1.0	1.0	2.0	10	25	10	58
III	1.0	0.3	1.3	5	40	5	59

THE UNITED REPUBLIC OF TANZANIA
 KILIMANJARO REGION
 THE MKOMAZI VALLEY AREA IRRIGATION DEVELOPMENT PROJECT
 TITLE OF DRAWING
 PROFILE OF HINGILILI FLOODWAY
 - GONJA SCHEME -
 JAPAN INTERNATIONAL COOPERATION AGENCY
 TOKYO

DWG NO.
5-6

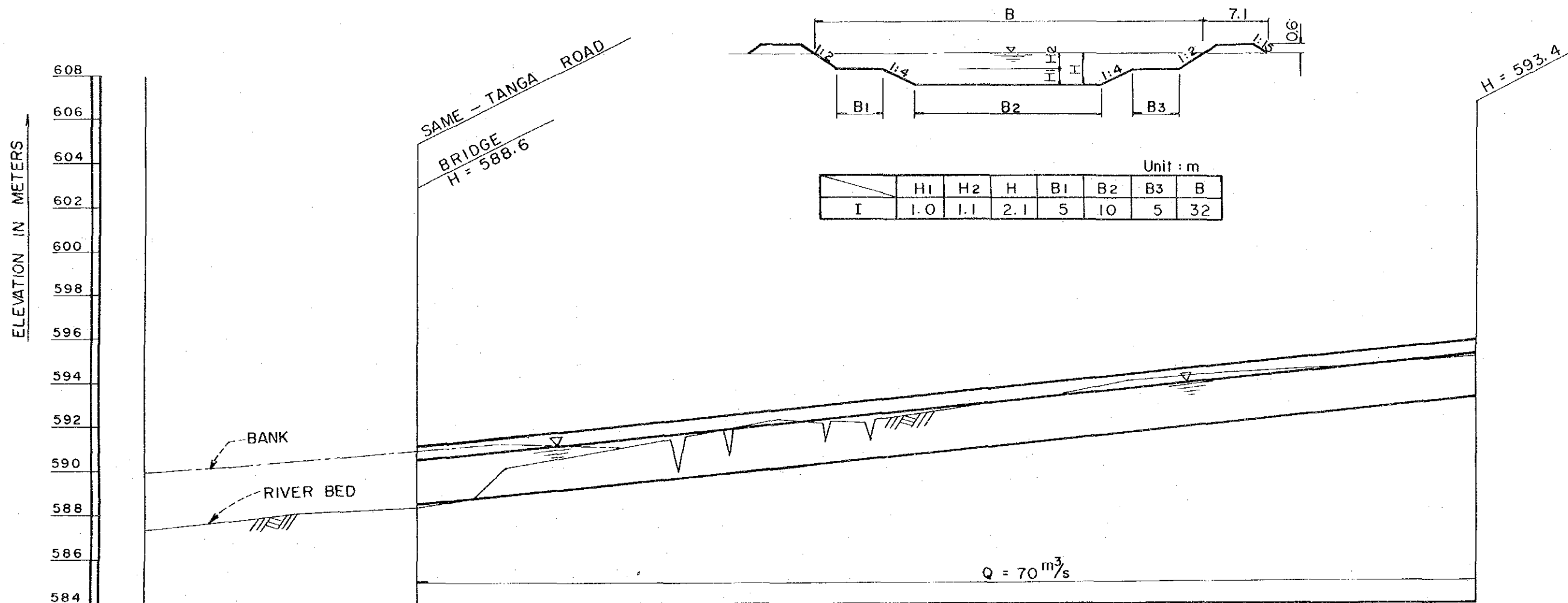

CANAL TYPE	I															
CANAL SLOPE	1/500															
GROUND SURFACE ELEVATION	587.3	587.7	588.1	588.4	590.1	590.8	591.6	592.3	592.2	592.7	593.3	594.0	594.4	594.6	595.0	595.2
REDUCED DISTANCE	600	400	200	0	200	400	600	800	1000	1200	1400	1600	1800	2000	2200	2400

THE UNITED REPUBLIC OF TANZANIA
 KILIMANJARO REGION
 THE MKOMAZI VALLEY AREA IRRIGATION DEVELOPMENT PROJECT

TITLE OF DRAWING
 PROFILE OF KAMBAGA RIVER (1/2)
 - IGOMA SCHEME -

JAPAN INTERNATIONAL COOPERATION AGENCY
 TOKYO

DWG. NO.
 5-7

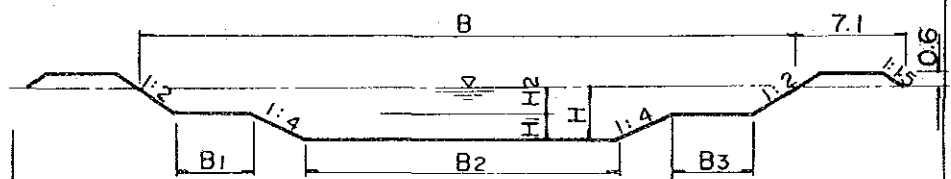
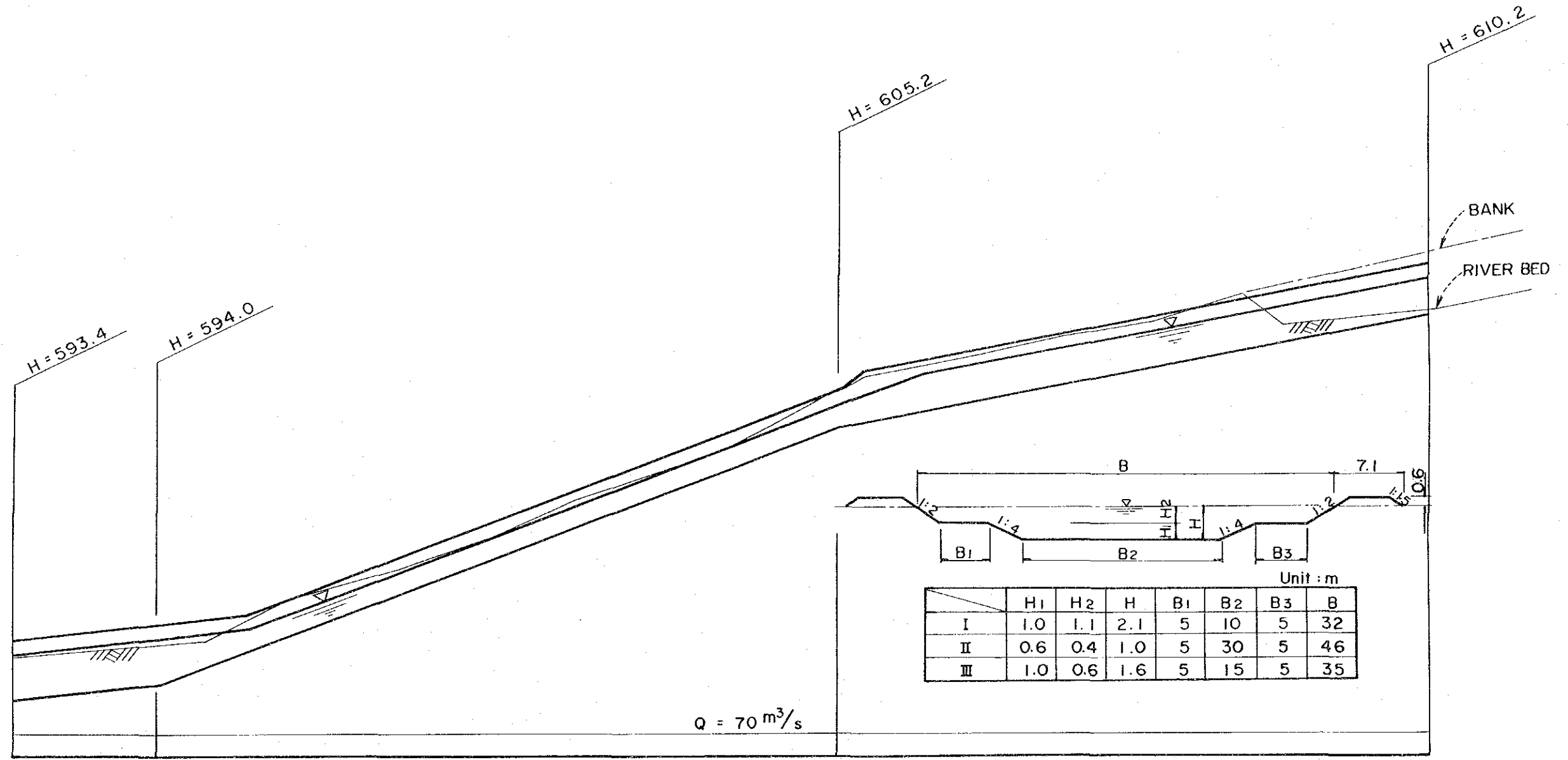
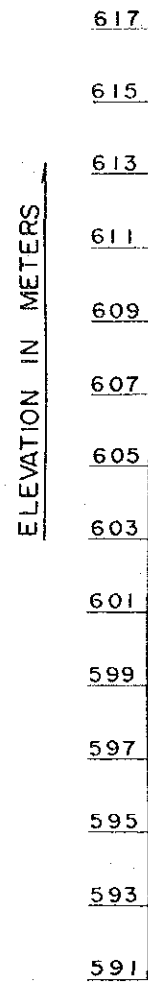

Unit : m

	H ₁	H ₂	H	B ₁	B ₂	B ₃	B
I	1.0	1.1	2.1	5	10	5	32
II	0.6	0.4	1.0	5	30	5	46
III	1.0	0.6	1.6	5	15	5	35

Q = 70 m³/s

CANAL TYPE	I		II						III							
CANAL SLOPE	1/500		1/130						1/250							
GROUND SURFACE ELEVATION	595.2	595.6	596.0	598.0	599.1	600.5	602.2	603.7	605.2	607.4	608.1	609.1	609.8	611.1	610.0	610.3
REDUCED DISTANCE	2400	2600	2800	3000	3200	3400	3600	3800	4000	4200	4400	4600	4800	5000	5200	5400

THE UNITED REPUBLIC OF TANZANIA
KILIMANJARO REGION
THE MKOMAZI VALLEY AREA IRRIGATION DEVELOPMENT PROJECT

TITLE OF DRAWING
PROFILE OF KAMBAGA RIVER (2/2)
- IGOMA SCHEME -

JAPAN INTERNATIONAL COOPERATION AGENCY
TOKYO

DWG. NO.
5-8

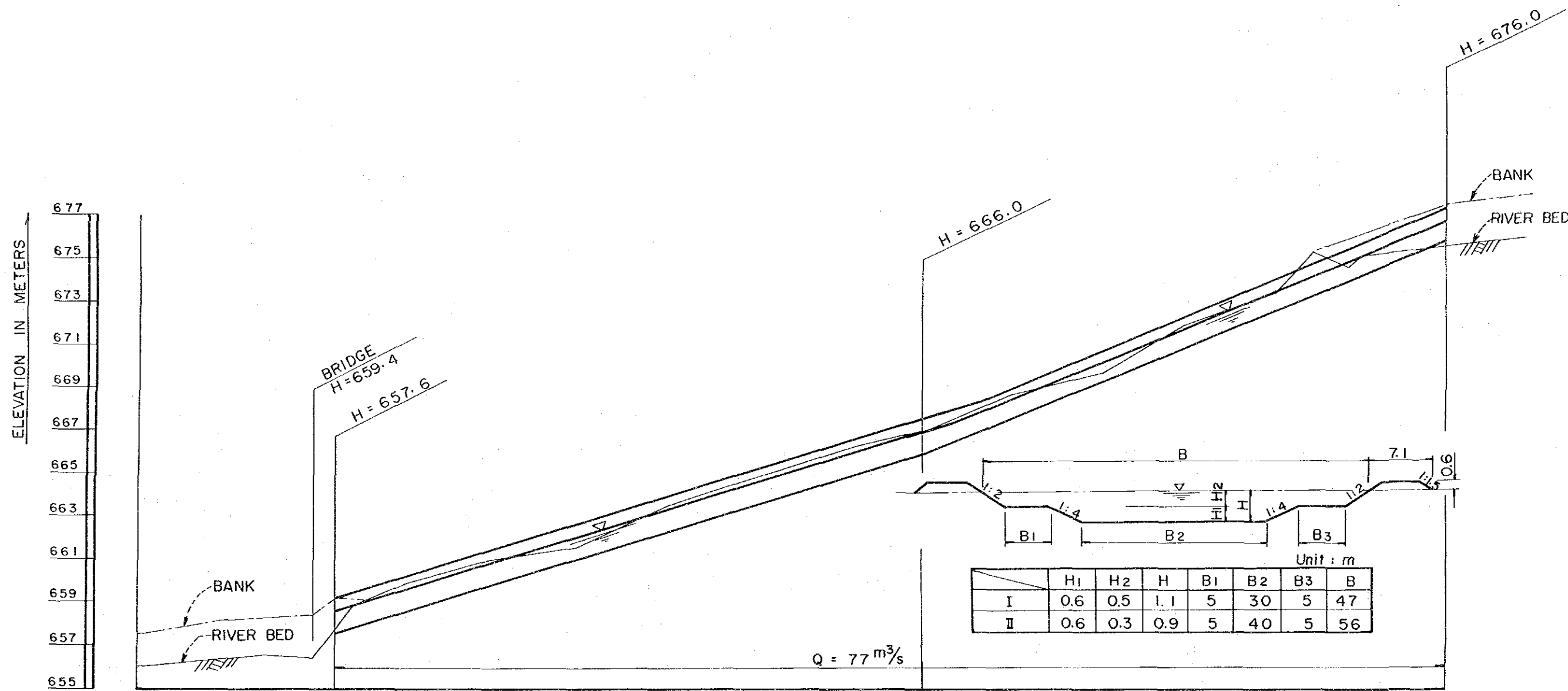

Unit : m

	H ₁	H ₂	H	B ₁	B ₂	B ₃	B
I	0.6	0.5	1.1	5	30	5	47
II	0.6	0.3	0.9	5	40	5	56

CANAL TYPE	I										II								
CANAL SLOPE	1/160										1/120								
GROUND SURFACE ELEVATION	656.6	656.4	659.0	659.8	660.9	661.6	663.4	664.7	666.0	667.0	668.8	669.7	672.0	673.4	675.2	674.5	675.1		
REDUCED DISTANCE	0	200	400	600	800	1000	1200	1400	1600	1800	2000	2200	2400	2600	2800	3000			

THE UNITED REPUBLIC OF TANZANIA
 KILIMANJARO REGION
 THE MKOMAZI VALLEY AREA IRRIGATION DEVELOPMENT PROJECT

TITLE OF DRAWING
 PROFILE OF NAKOMBO RIVER
 - KISIWANI SCHEME -

JAPAN INTERNATIONAL COOPERATION AGENCY
 TOKYO

DWG. NO.
 5-9

TURNOUT
TYPE - A

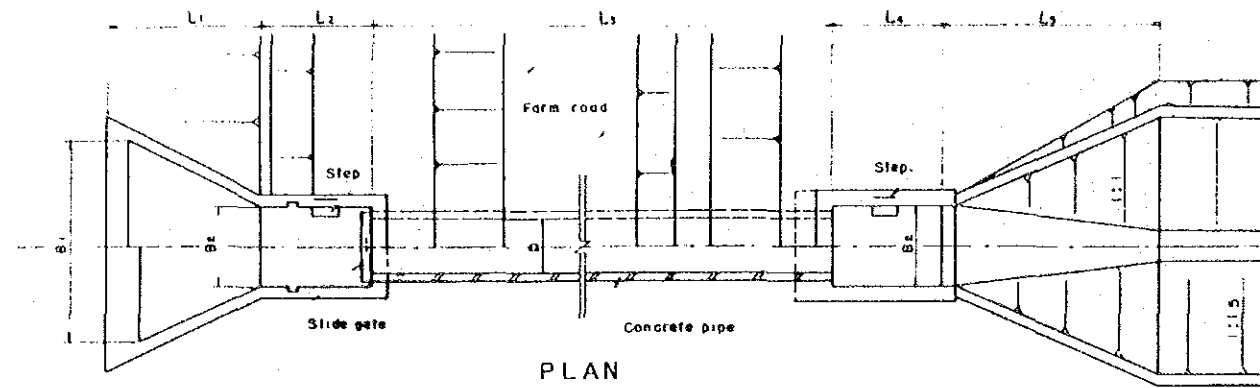

PLAN

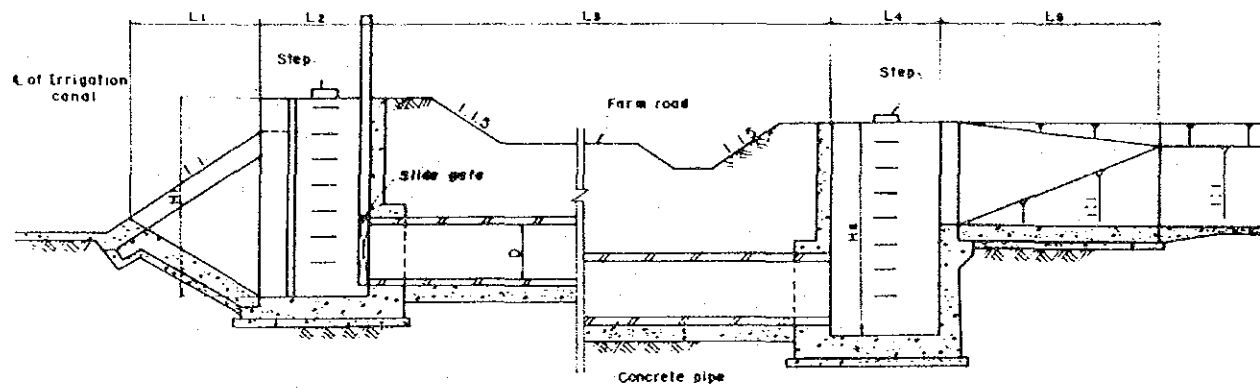

PROFILE

TYPE - B

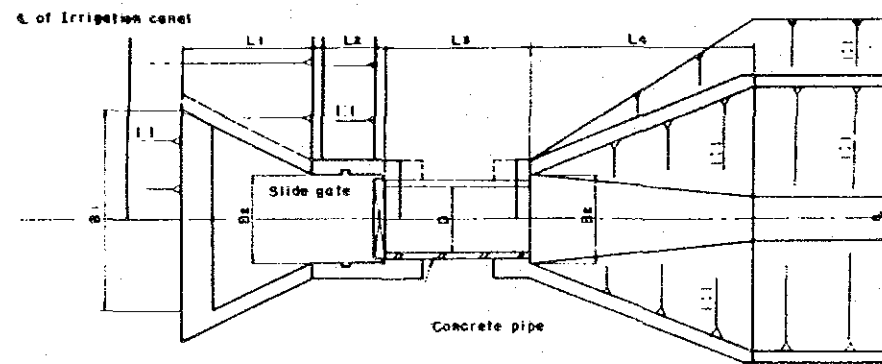

PLAN

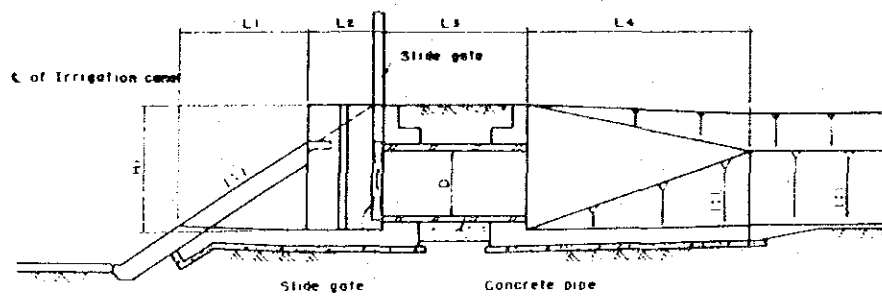

PROFILE

CHECK

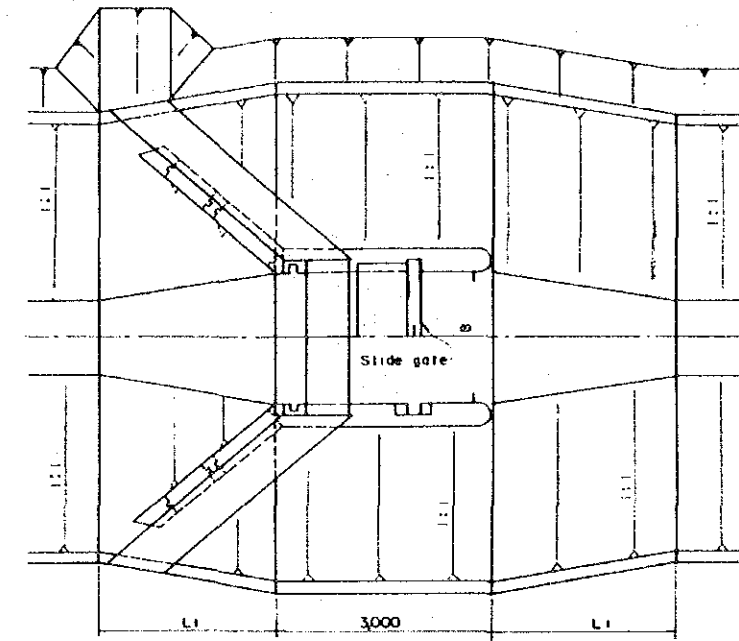

PLAN

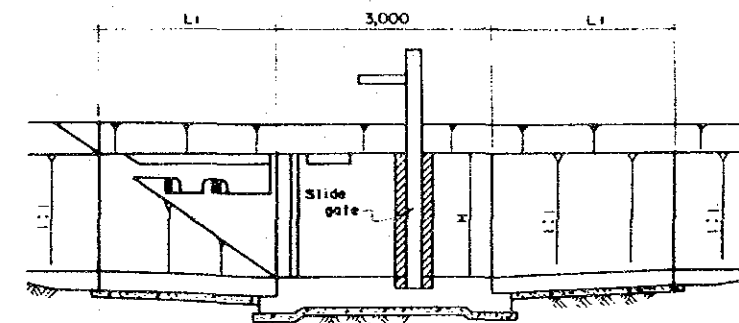

PROFILE

Unit: mm

D	TYPE-A			TYPE-B	
	L2	L4	B2	L2	L4
400	800	800	600	800	600
500	900	900	700	900	700
600	1,100	1,050	800	1,100	850
700	1,300	1,200	1,000	1,300	1,000
800	1,400	1,300	1,100	1,400	1,100

DIMENSION OF TURNOUTS

THE UNITED REPUBLIC OF TANZANIA
KILIMANJARO REGION
THE MKOMAZI VALLEY AREA IRRIGATION DEVELOPMENT PROJECT

TITLE OF DRAWING
TURNOUT & CHECK

JAPAN INTERNATIONAL COOPERATION AGENCY
TOKYO

DWG. NO.
6-1

CULVERT

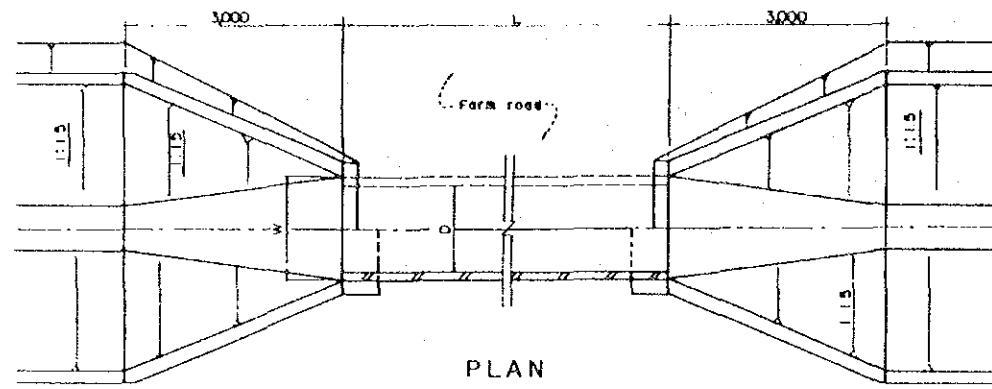

PLAN

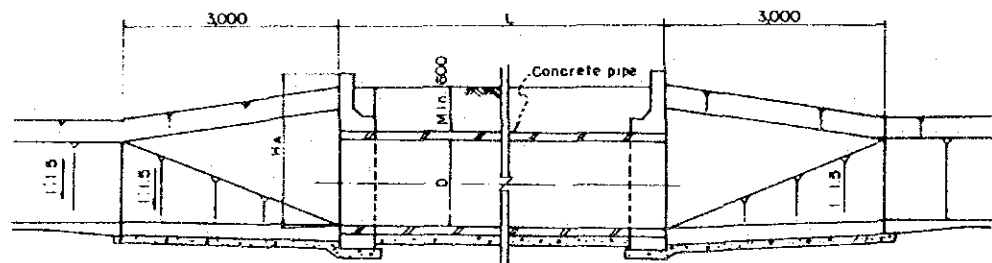

PROFILE

Unit : mm

TYPE	Q (m ³ /s)	D	W	HA
I	0.5~	800	960	1,600
II	0.1~0.5	500	600	1,300
III	~0.1	300	360	1,100

Unit : mm

ROAD	L
MAIN	8,000
SECONDARY	7,000
TERTIARY	7,000

DIMENSION OF CULVERTS

SIPHON

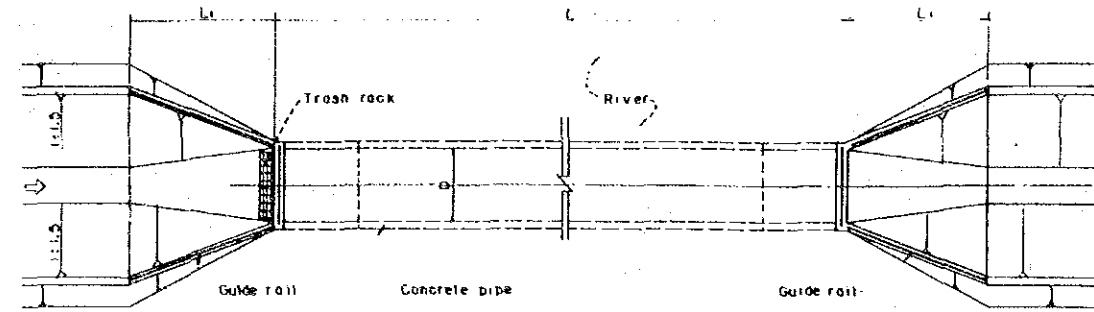

PLAN

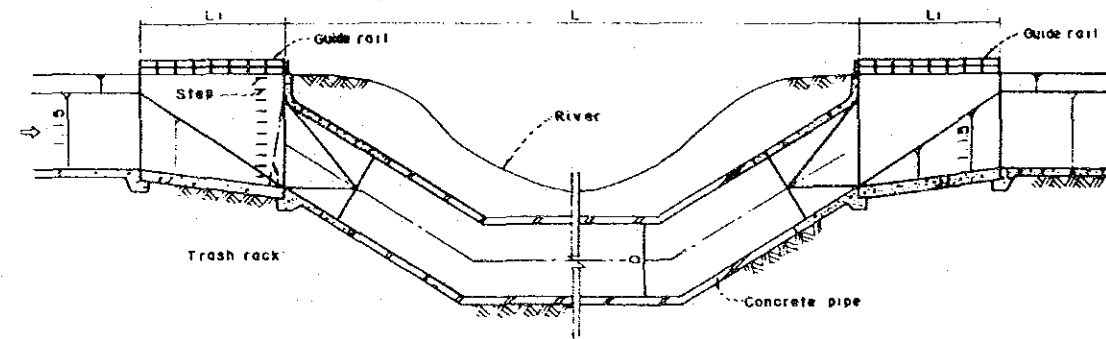

PROFILE

Unit : m

TYPE	D	L	L ₁
I	0.7	80~90	3.0
II	0.8	50~65	3.0

DIMENSION OF SIPHONS

THE UNITED REPUBLIC OF TANZANIA KILIMANJARO REGION THE MKOMAZI VALLEY AREA IRRIGATION DEVELOPMENT PROJECT	
TITLE OF DRAWING CULVERT & SIPHON	
JAPAN INTERNATIONAL COOPERATION AGENCY TOKYO	DWG. NO. 6-2

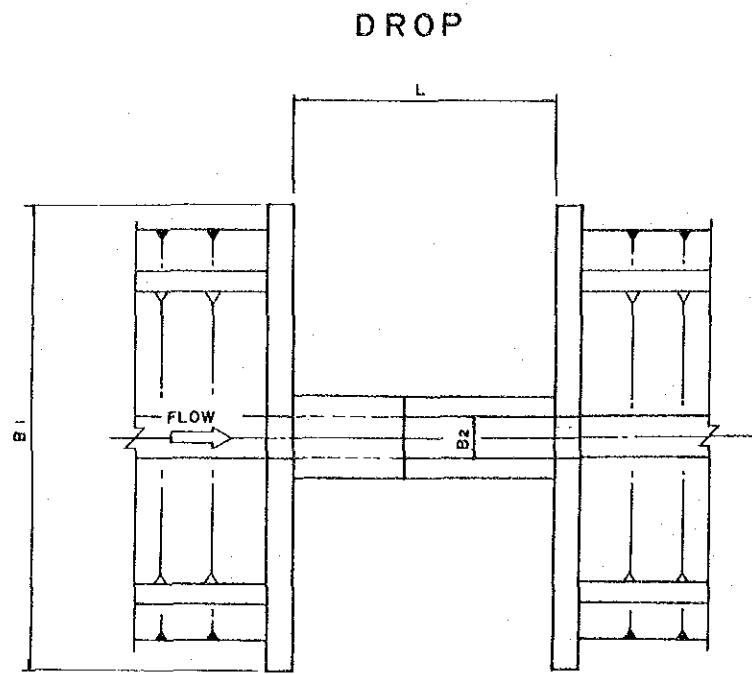

PLAN

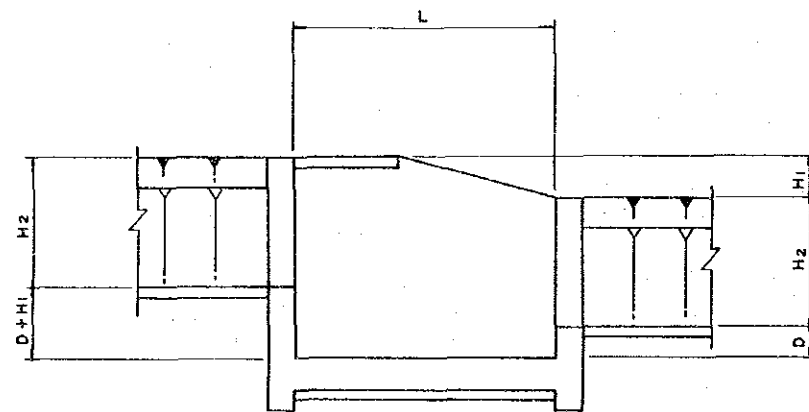

PROFILE

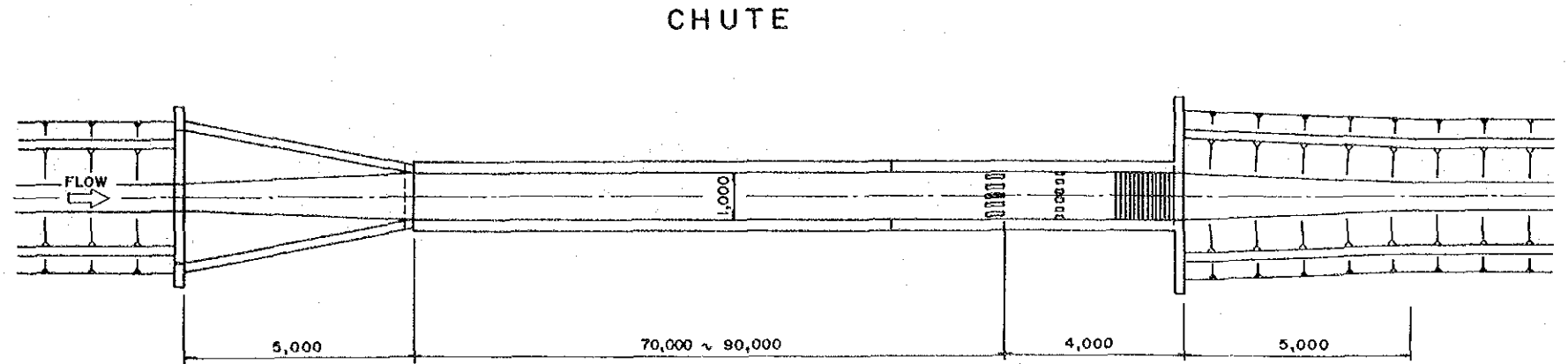

PLAN

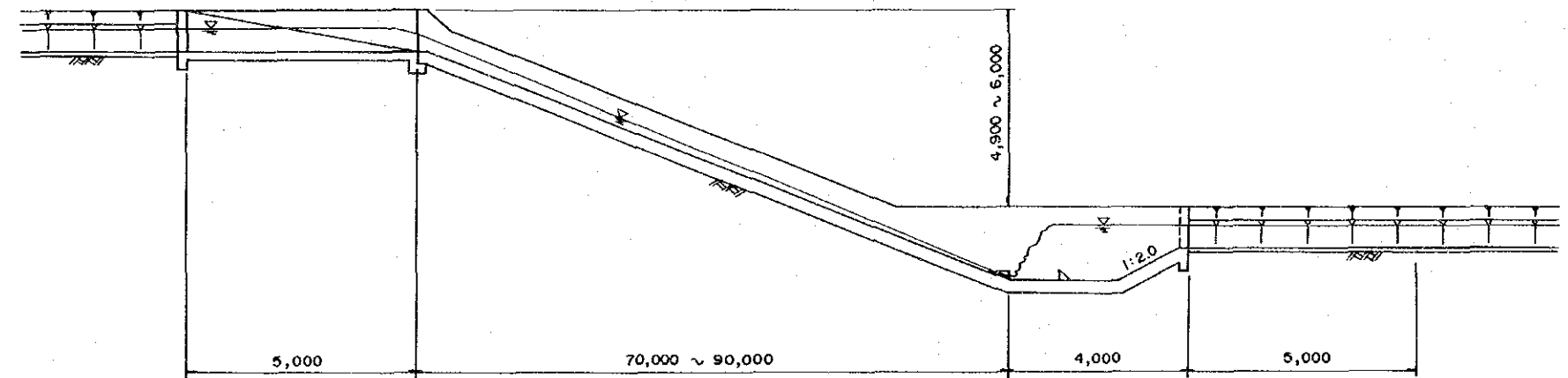

PROFILE

Unit : mm

TYPE	Q (m ³ /s)	H1	H2	B	B	L	D
I	0 < Q ≤ 0.5	500	950	3,200	300	3,000	300
II	0 < Q ≤ 0.5	1,000	950	3,200	300	4,000	300
III	0 < Q ≤ 0.5	1,500	950	3,200	300	5,000	300
IV	0.5 < Q < 1.0	500	1,150	4,300	400	3,000	400
V	0.5 < Q < 1.0	1,000	1,150	4,300	400	4,000	400
VI	0.5 < Q < 1.0	1,500	1,150	4,300	400	5,000	400

DIMENSION OF DROPS

THE UNITED REPUBLIC OF TANZANIA
KILIMANJARO REGION
THE MKOMAZI VALLEY AREA IRRIGATION DEVELOPMENT PROJECT

TITLE OF DRAWING
DROP & CHUTE

JAPAN INTERNATIONAL COOPERATION AGENCY DWG. NO.
TOKYO 6-3

SPILLWAY

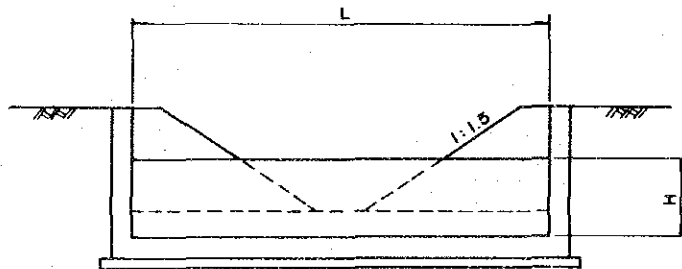
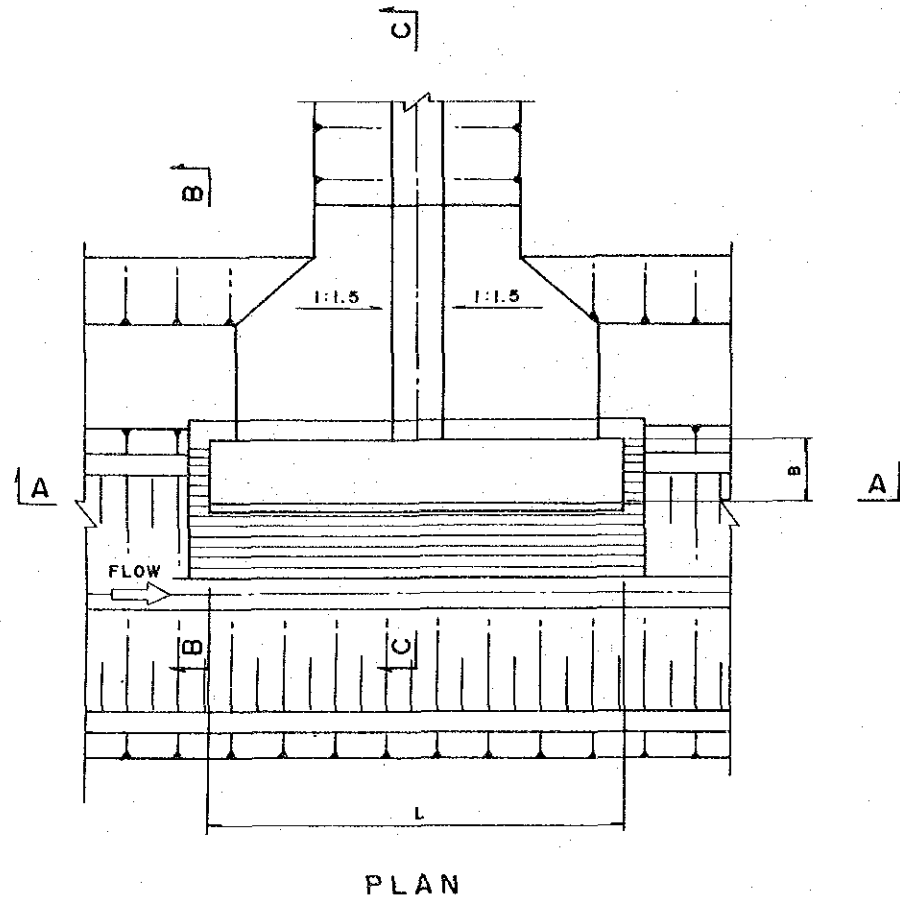

SECTION A - A

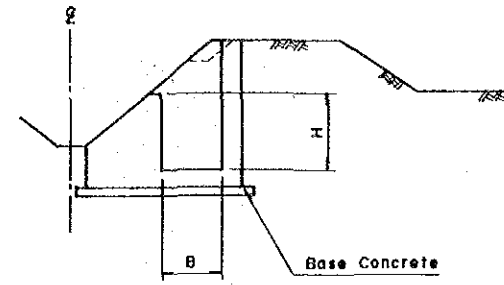

SECTION B - B

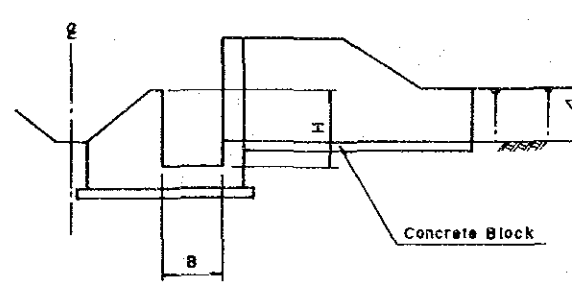

SECTION C - C

Unit : mm

TYPE	Q (m ³ /s)	B	H	L
I	~0.5	500~600	500~600	2,000~4,000
II	0.5~0.8	700~900	700~800	6,000
III	0.8~	900~1200	900	9,000~11,000

DIMENSION OF SPILLWAYS

WASTEWAY

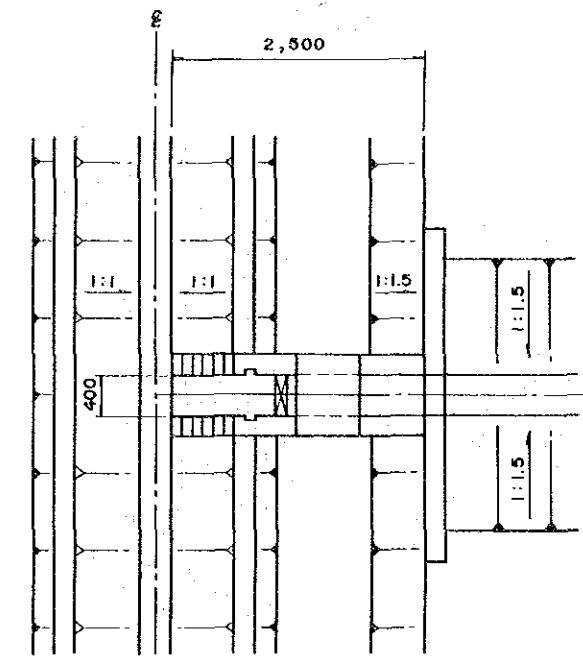

PLAN

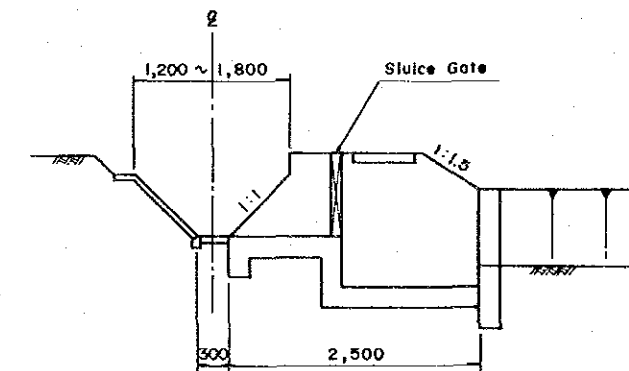

PROFILE

THE UNITED REPUBLIC OF TANZANIA KILIMANJARO REGION THE MKOMAZI VALLEY AREA IRRIGATION DEVELOPMENT PROJECT	
TITLE OF DRAWING SPILLWAY & WASTEWAY	
JAPAN INTERNATIONAL COOPERATION AGENCY TOKYO	DWG. NO. 6-4

CROSSDRAIN

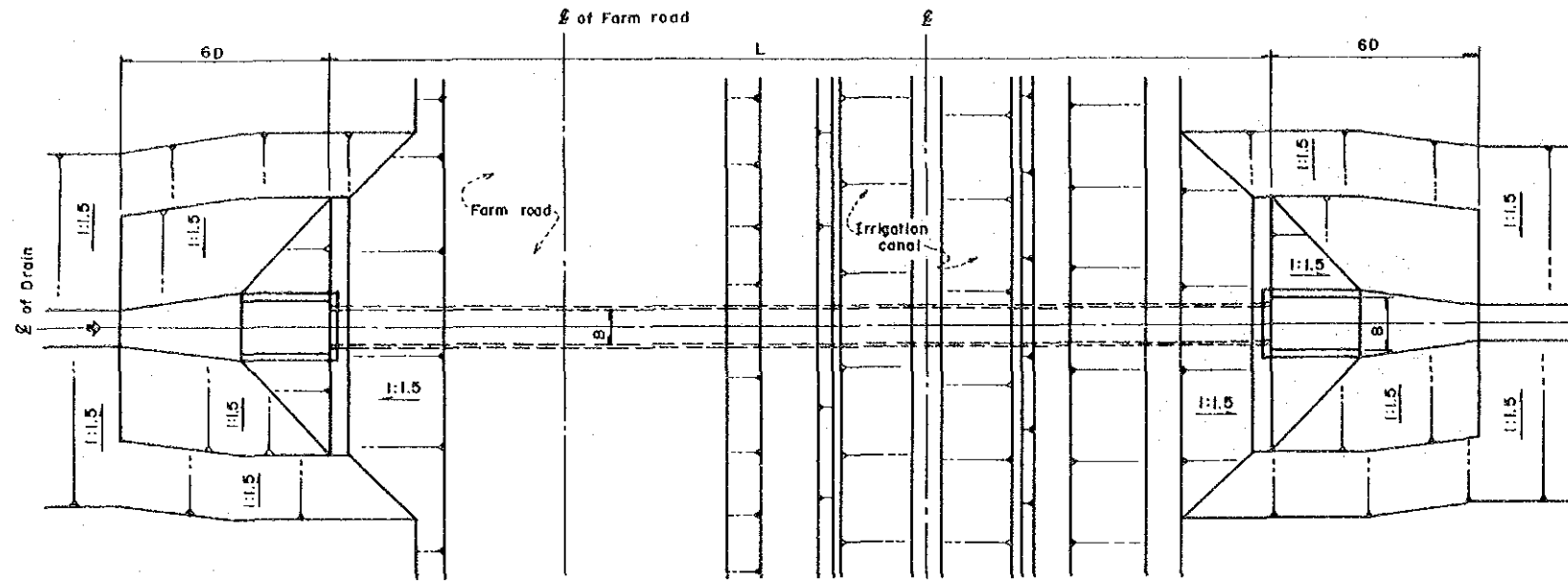

PLAN

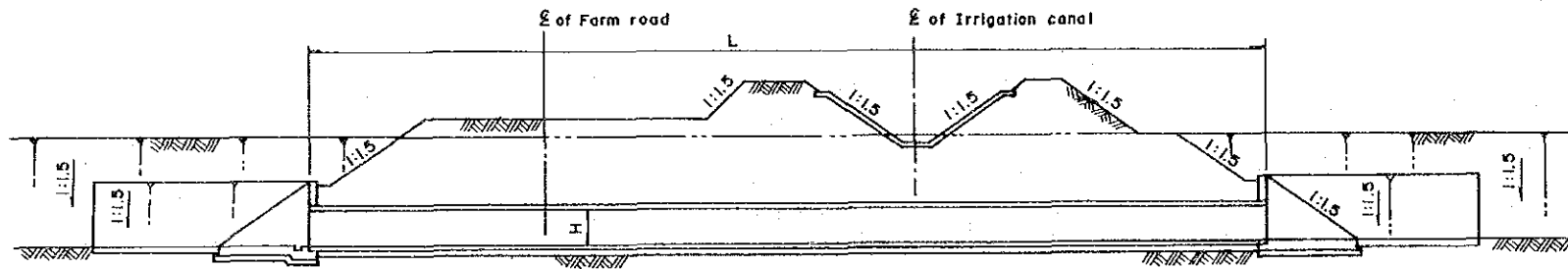

PROFILE

TYPE	Q (m ³ /s)	B (m)	H (m)	BARREL NOS.
I	67.5~52.5	2.5	2.5	9
II	52.5~37.5	2.5	2.5	7
III	37.5~30.0	2.5	2.5	5
IV	30.0~22.5	2.5	2.5	4
V	22.5~15.0	2.5	2.5	3
VI	15.0~7.5	2.5	2.5	2
VII	7.5~5.4	1.5	1.5	2
VIII	5.4~2.4	1.0	1.0	2
IX	2.4~1.8	1.5	1.0	1
X	1.8~	pipe D=1,000mm		1

Unit: m

TYPE	b	h	l
A	2.0	0.5	4.0
B	2.0	0.5	3.0
C	1.5	0.5	2.0
D	1.0	0.5	1.5

Unit: m

TYPE	d	l
E	0.5	3.0
F	0.5	4.0

DIMENSION OF GABIONS

CANAL TYPE	L (m)
A, B	18
C1, C2, C3	14
SECONDARY	11

DIMENSION OF CROSS DRAINS

DRAINAGE DROP

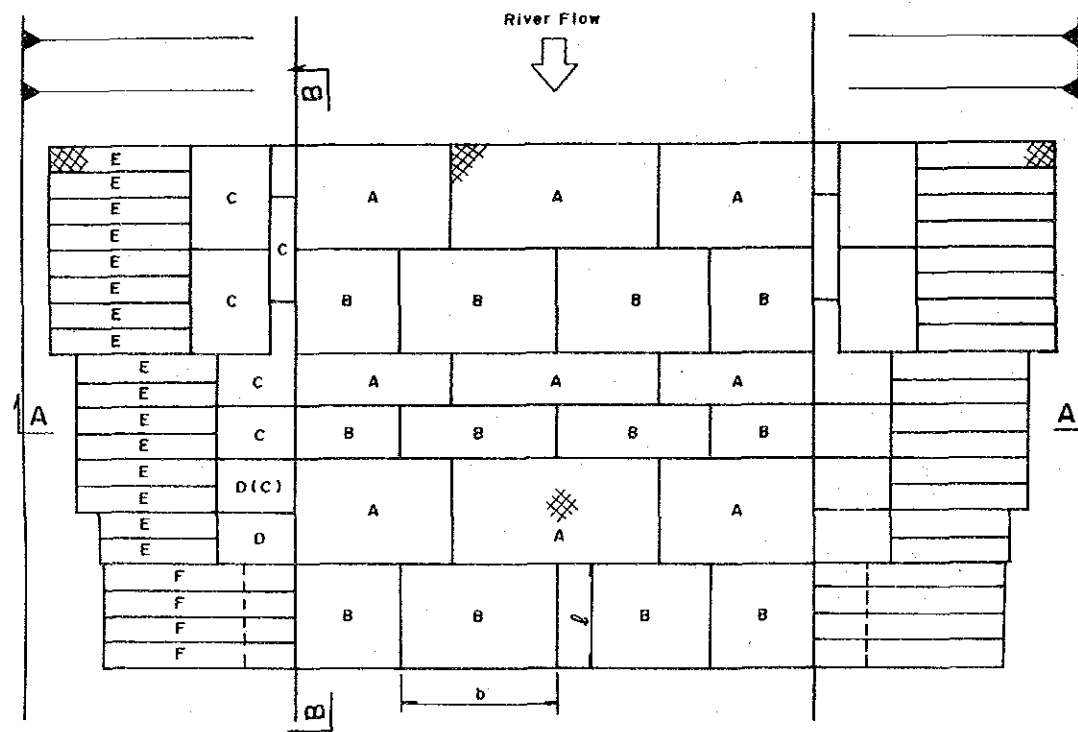

PLAN

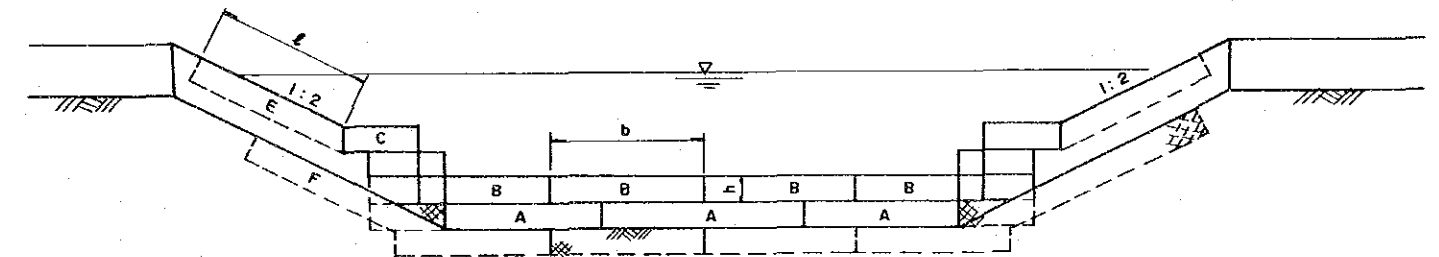

SECTION A - A

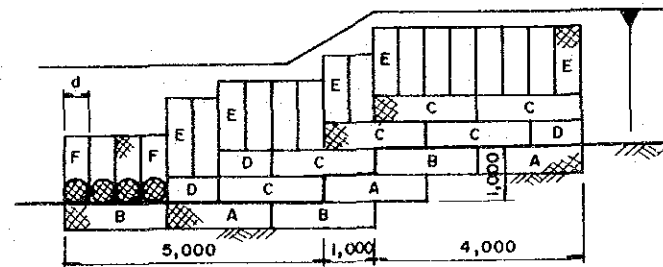

SECTION B - B

THE UNITED REPUBLIC OF TANZANIA KILIMANJARO REGION	
THE MKOMAZI VALLEY AREA IRRIGATION DEVELOPMENT PROJECT	
TITLE OF DRAWING CROSSDRAIN & DRAINAGE DROP	
JAPAN INTERNATIONAL COOPERATION AGENCY TOKYO	DWG. NO. 6-5

IRRIGATION CANAL

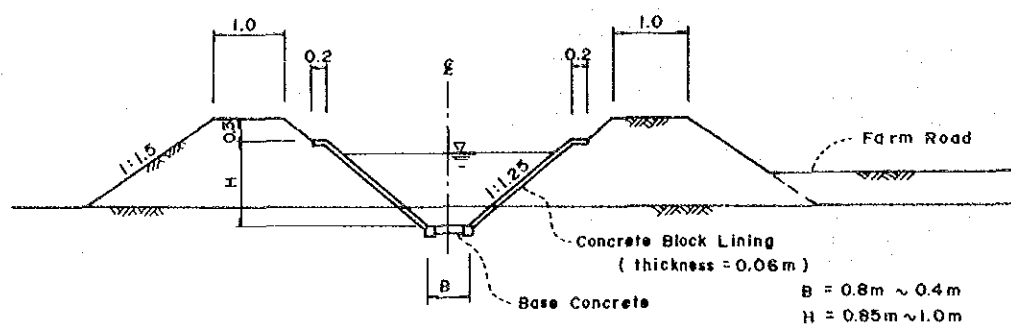

FLOODWAY & DRAINAGE CANAL

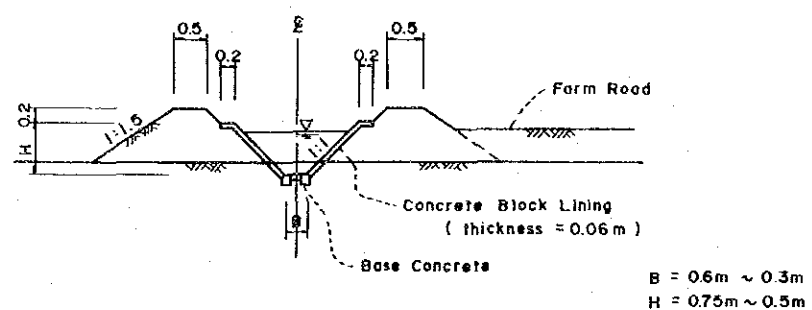
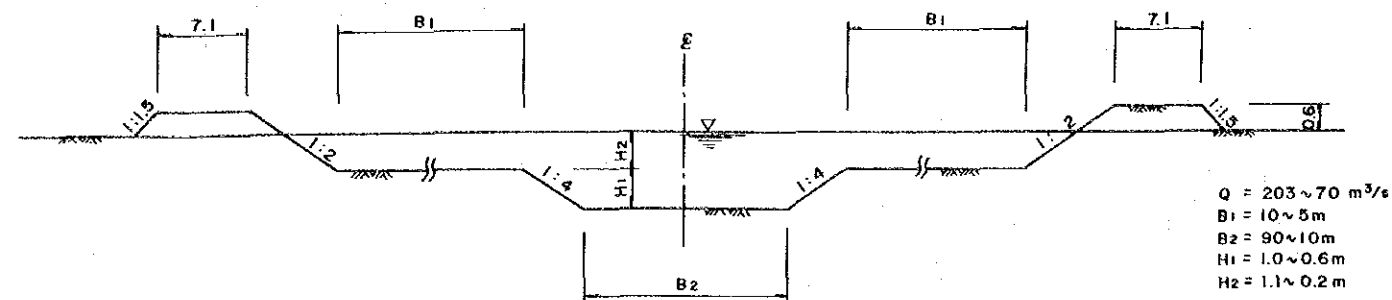

FLOODWAY

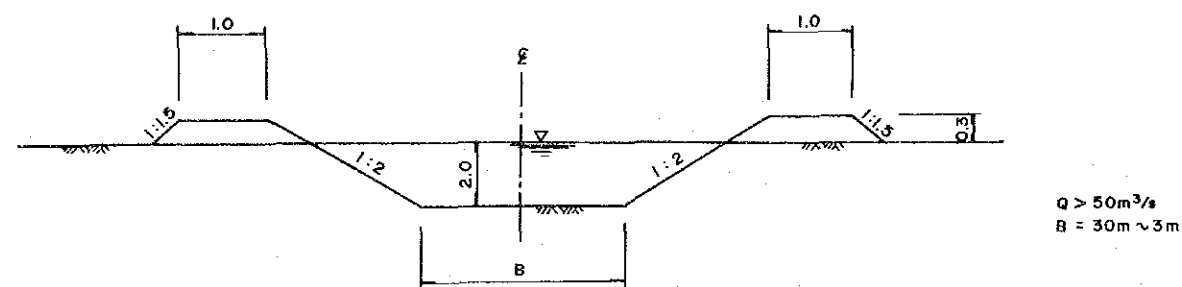

FARM ROAD

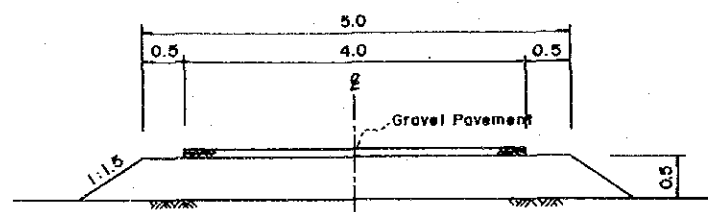

MAIN DRAINAGE CANAL

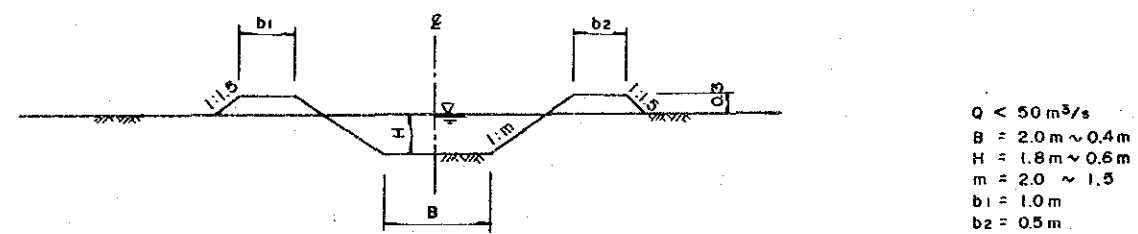

MAIN FARM ROAD

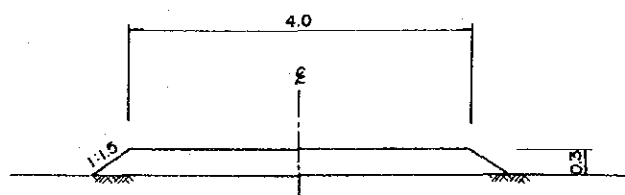

SECONDARY DRAINAGE CANAL

SECONDARY FARM ROAD

THE UNITED REPUBLIC OF TANZANIA KILIMANJARO REGION THE MKOMAZI VALLEY AREA IRRIGATION DEVELOPMENT PROJECT	
TITLE OF DRAWING TYPICAL CROSS SECTION OF IRRIGATION CANAL, FARM ROAD, FLOODWAY & DRAINAGE CANAL	
JAPAN INTERNATIONAL COOPERATION AGENCY TOKYO	DWG. NO. 6-6

JICA