

STATE OF QATAR		SCALE
THE STUDY ON DRAINAGE IMPROVEMENT PLAN, DOHA CITY		1:2000
DISCHARGE PIPE LINE DETAILED PLAN (3/9)		DRP 1 4022
JICA JAPAN INTERNATIONAL COOPERATION AGENCY		
DRAWN	CHECKED	APPROVED
<i>[Signature]</i>	<i>[Signature]</i>	<i>[Signature]</i>

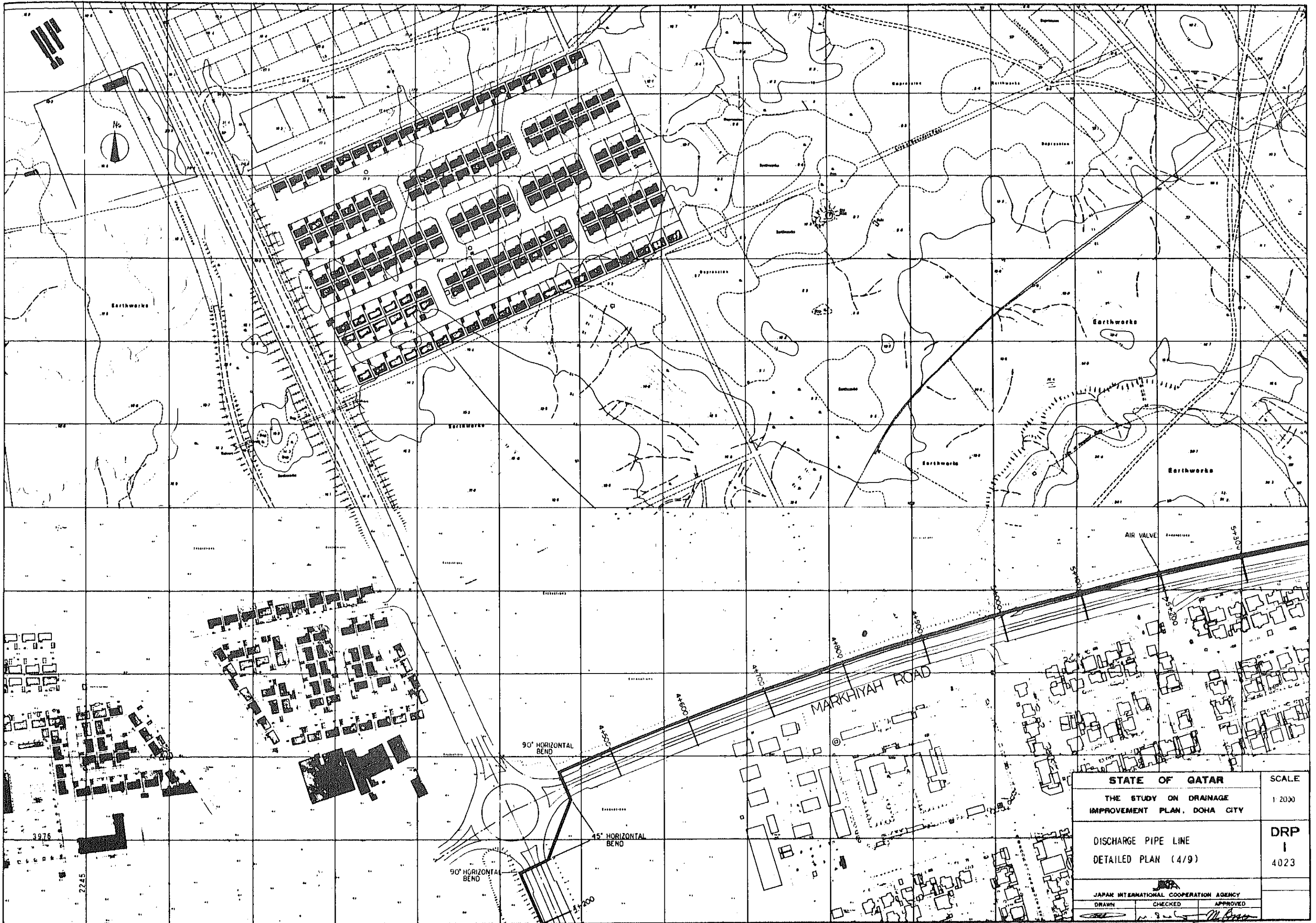

STATE OF QATAR		SCALE
THE STUDY ON DRAINAGE IMPROVEMENT PLAN, DOHA CITY		1:2000
DISCHARGE PIPE LINE DETAILED PLAN (4/9)		DRP 1 4023
 JAPAN INTERNATIONAL COOPERATION AGENCY		
DRAWN	CHECKED	APPROVED

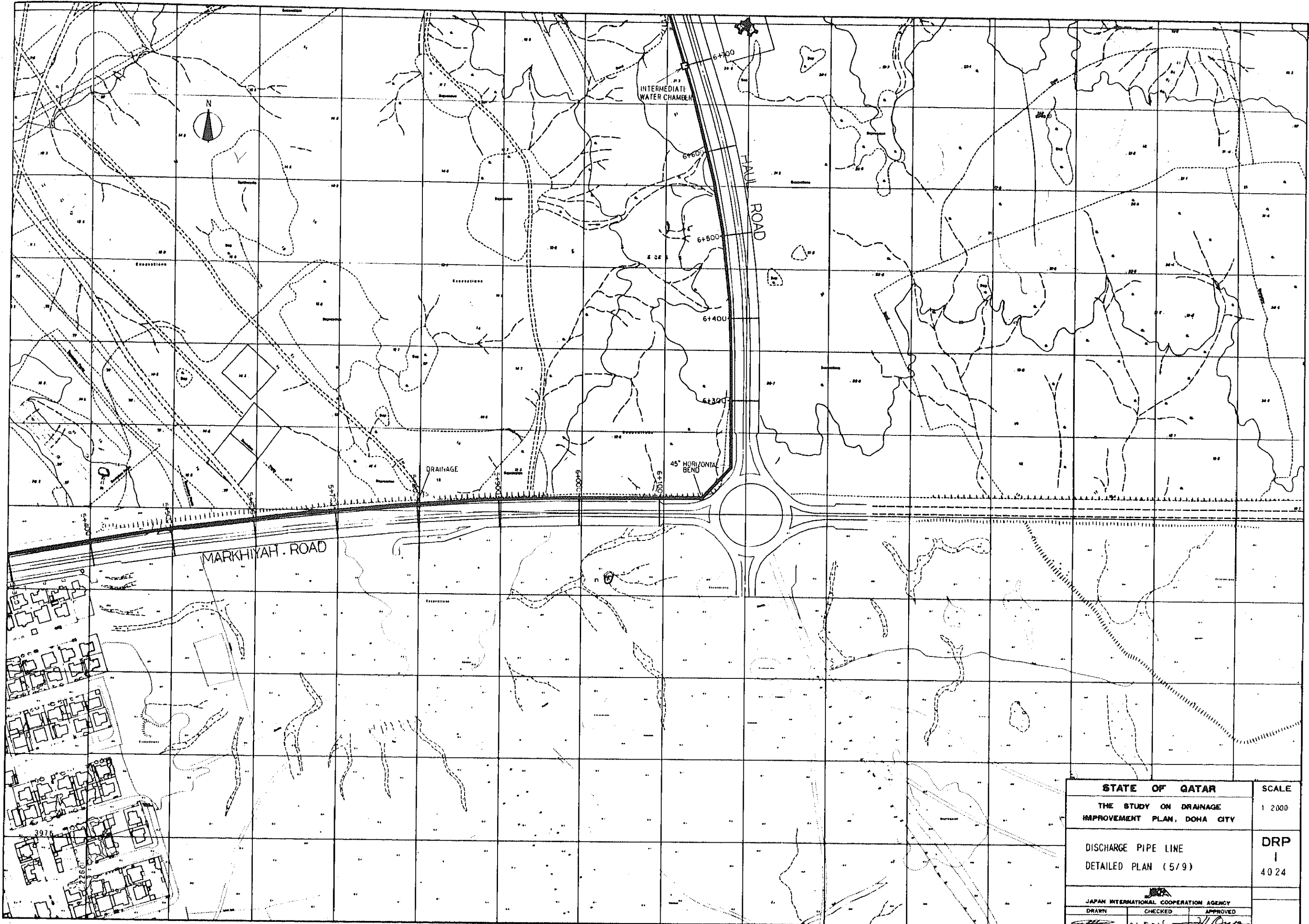

STATE OF QATAR		SCALE
THE STUDY ON DRAINAGE IMPROVEMENT PLAN, DOHA CITY		1:2000
DISCHARGE PIPE LINE DETAILED PLAN (5/9)		DRP I 4024
JAPAN INTERNATIONAL COOPERATION AGENCY		
DRAWN	CHECKED	APPROVED
<i>[Signature]</i>	<i>[Signature]</i>	<i>[Signature]</i>

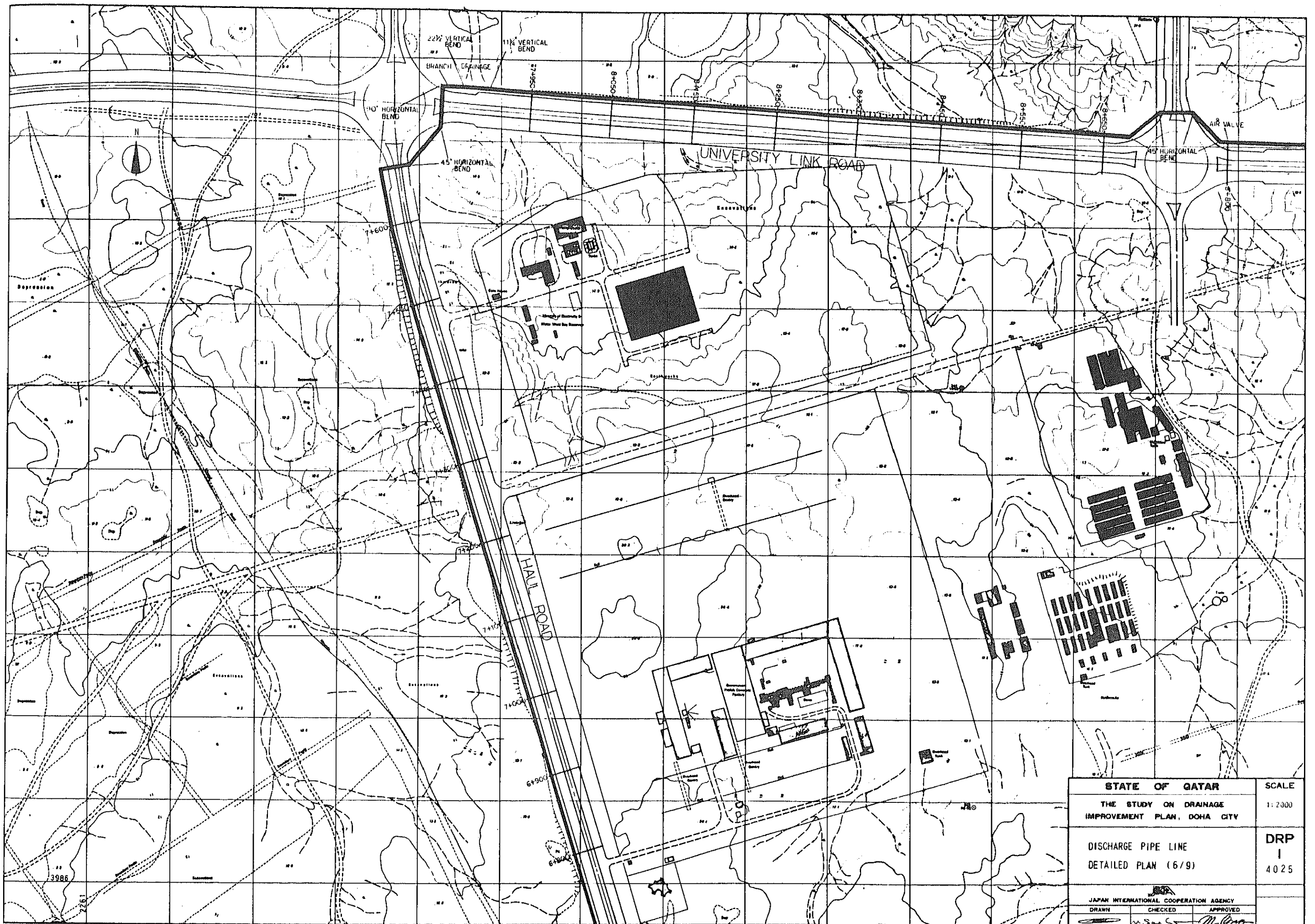

STATE OF QATAR		SCALE
THE STUDY ON DRAINAGE IMPROVEMENT PLAN, DOHA CITY		1:2000
DISCHARGE PIPE LINE DETAILED PLAN (6/9)		DRP 1 4025
JAPAN INTERNATIONAL COOPERATION AGENCY		
DRAWN	CHECKED	APPROVED



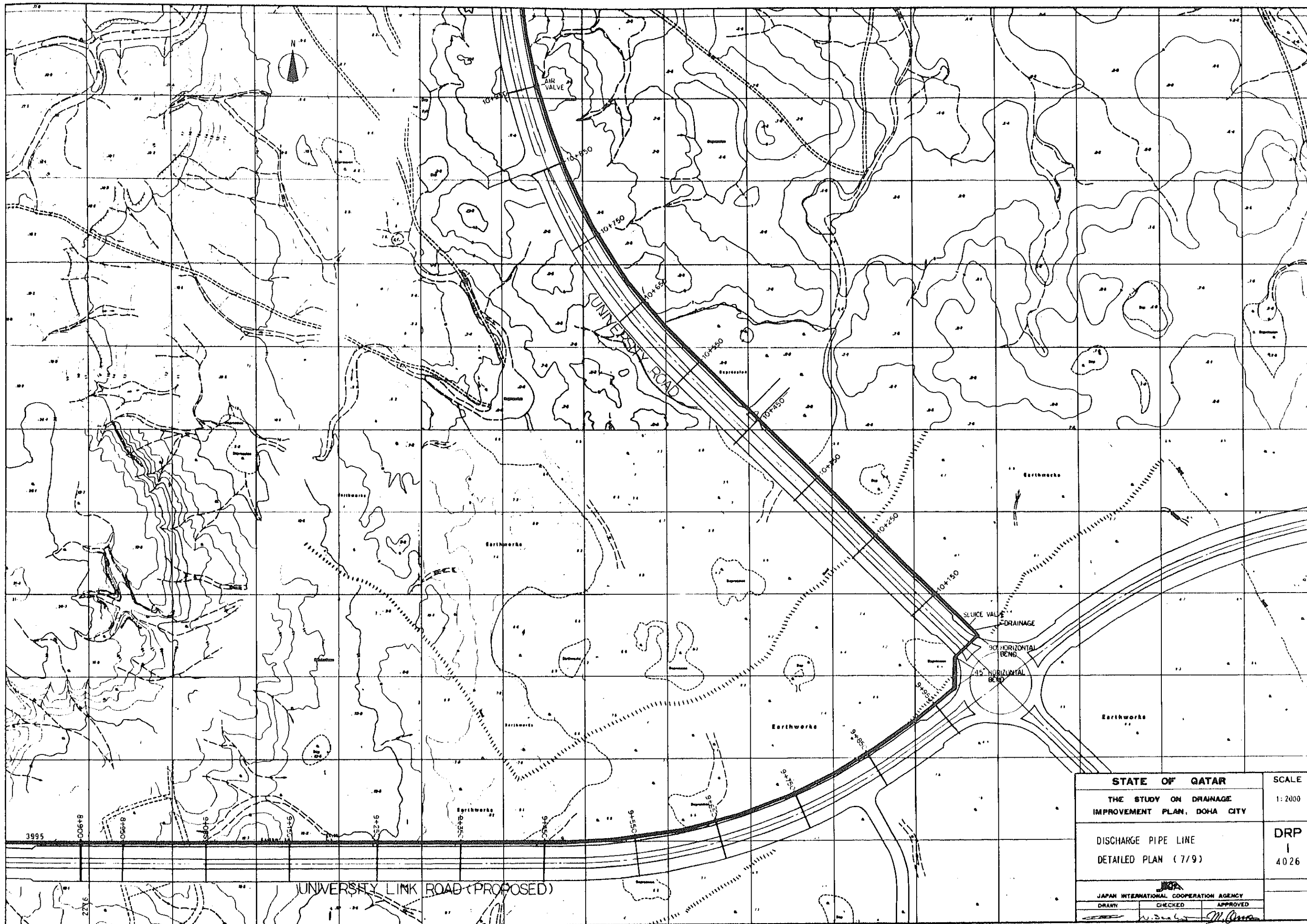

<b>STATE OF QATAR</b>		SCALE
THE STUDY ON DRAINAGE IMPROVEMENT PLAN, DOHA CITY		1:2000
DISCHARGE PIPE LINE DETAILED PLAN (7/9)		DRP 1 4026
JAPAN INTERNATIONAL COOPERATION AGENCY		
DRAWN	CHECKED	APPROVED
<i>[Signature]</i>	<i>[Signature]</i>	<i>[Signature]</i>

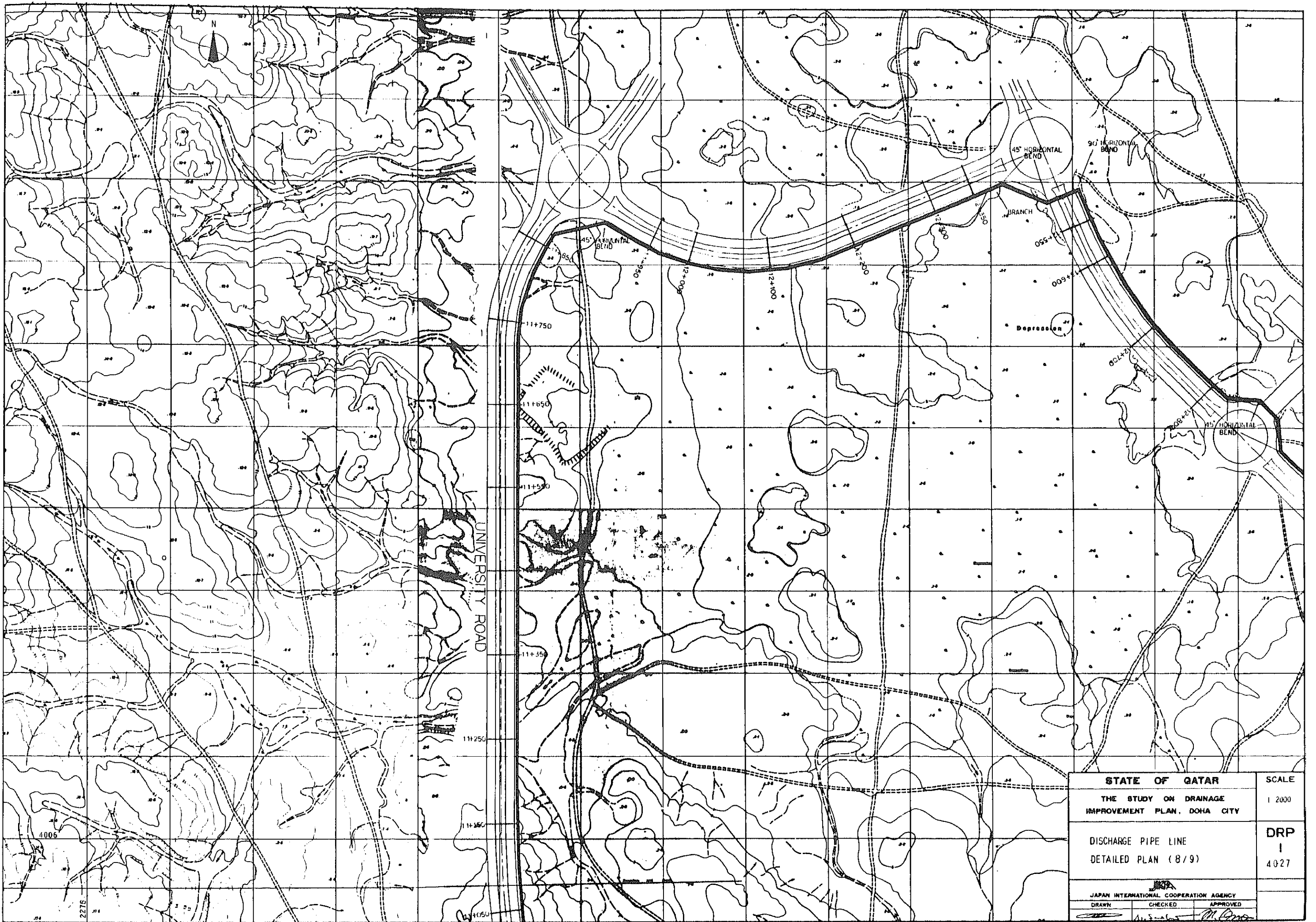

STATE OF QATAR		SCALE
THE STUDY ON DRAINAGE IMPROVEMENT PLAN, DOHA CITY		1:2000
DISCHARGE PIPE LINE DETAILED PLAN (8/9)		DRP 1 4027
 JAPAN INTERNATIONAL COOPERATION AGENCY		
DRAWN	CHECKED	APPROVED

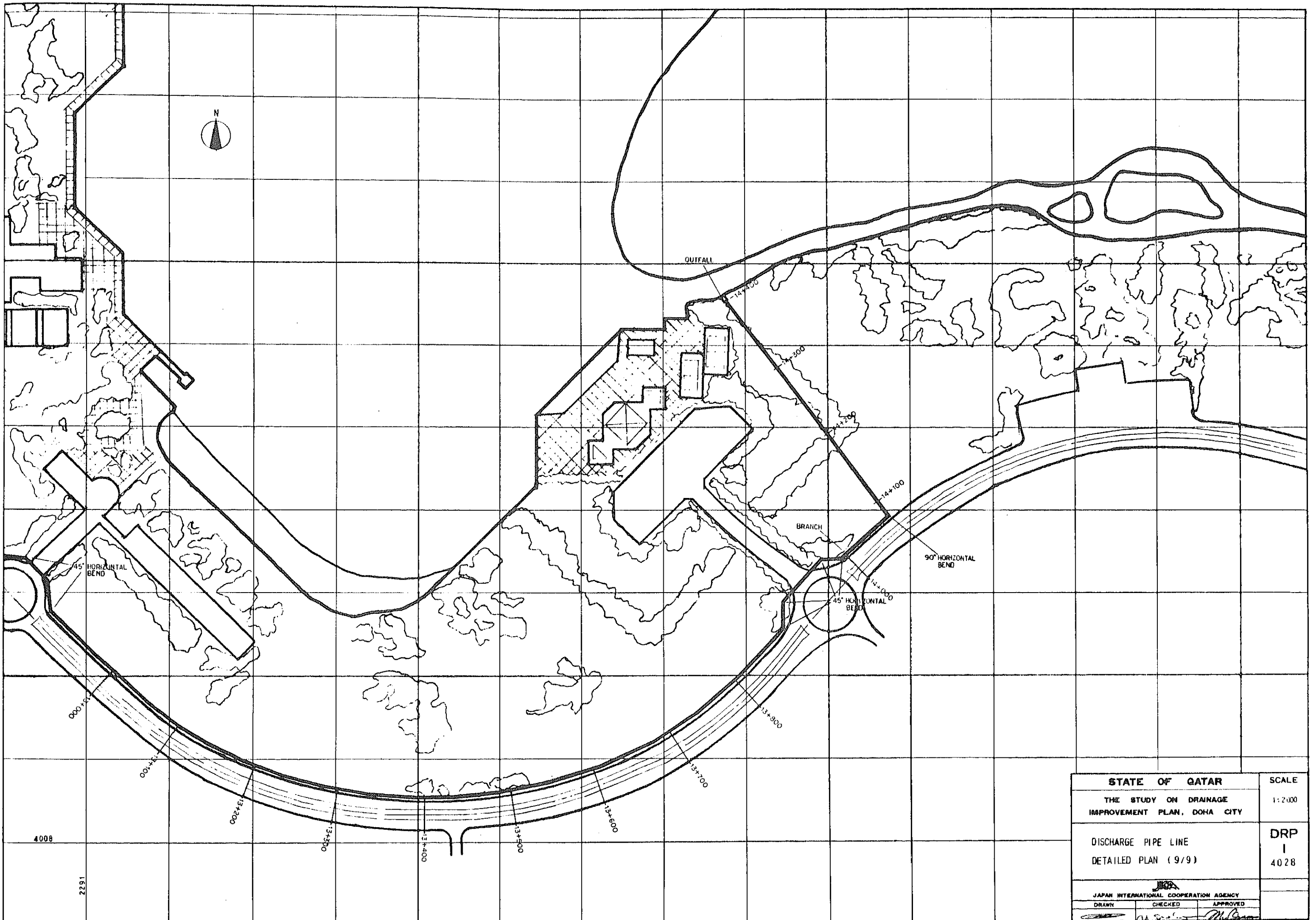

STATE OF QATAR		SCALE
THE STUDY ON DRAINAGE IMPROVEMENT PLAN, DOHA CITY		1:2000
DISCHARGE PIPE LINE		DRP
DETAILED PLAN (9/9)		4028
JAPAN INTERNATIONAL COOPERATION AGENCY		
DRAWN	CHECKED	APPROVED

METRES ABOVE  
QATAR NATIONAL  
DATUM

OFFSET

LEVEL

CHAINAGE

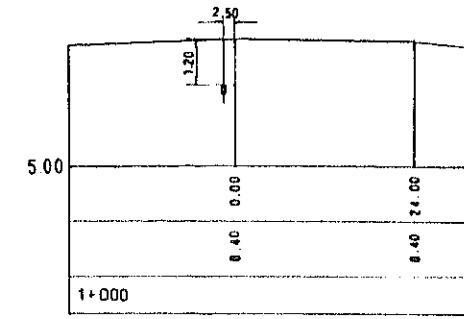
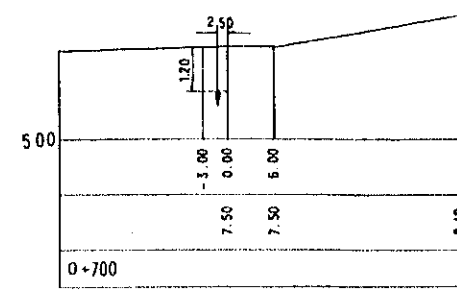
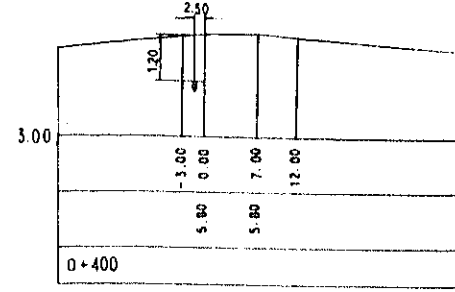
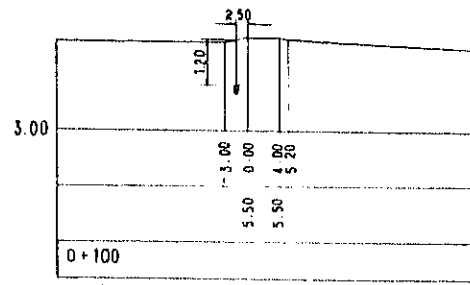

METRES ABOVE  
QATAR NATIONAL  
DATUM

OFFSET

LEVEL

CHAINAGE

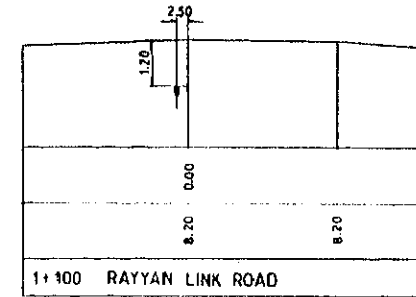
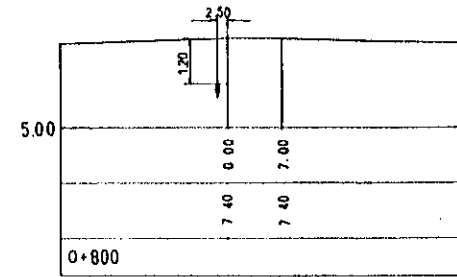
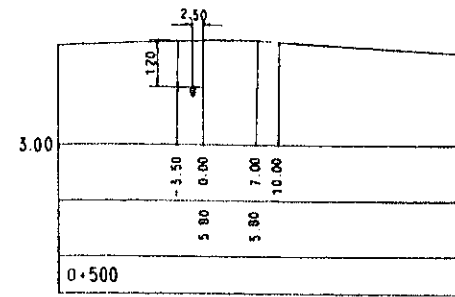
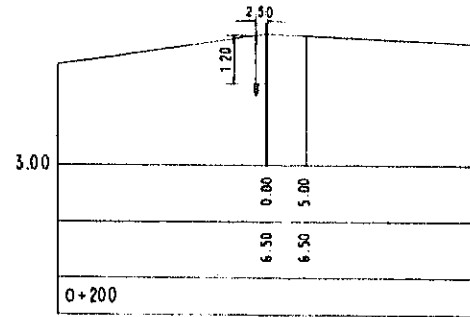

METRES ABOVE  
QATAR NATIONAL  
DATUM

OFFSET

LEVEL

CHAINAGE

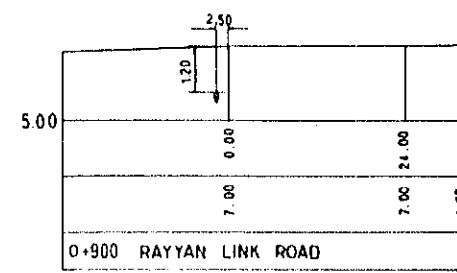
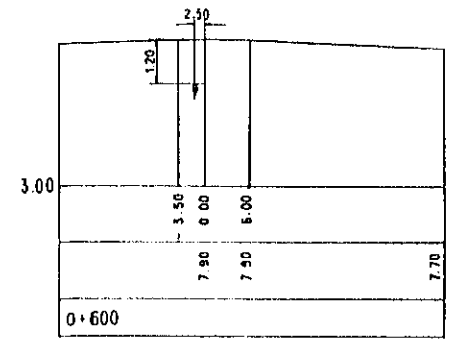
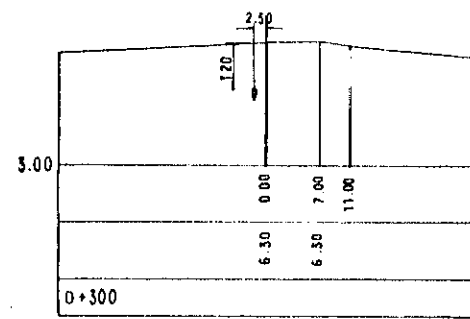

Vertical Scale 1:100 Horizontal Scale 1:500

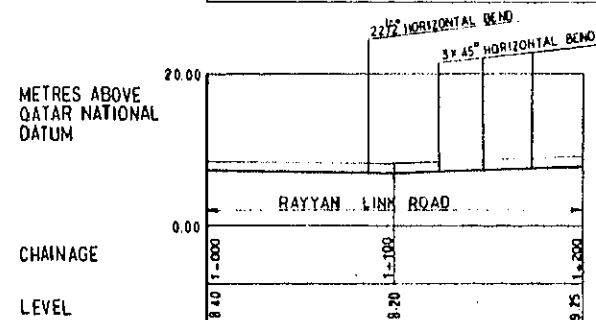
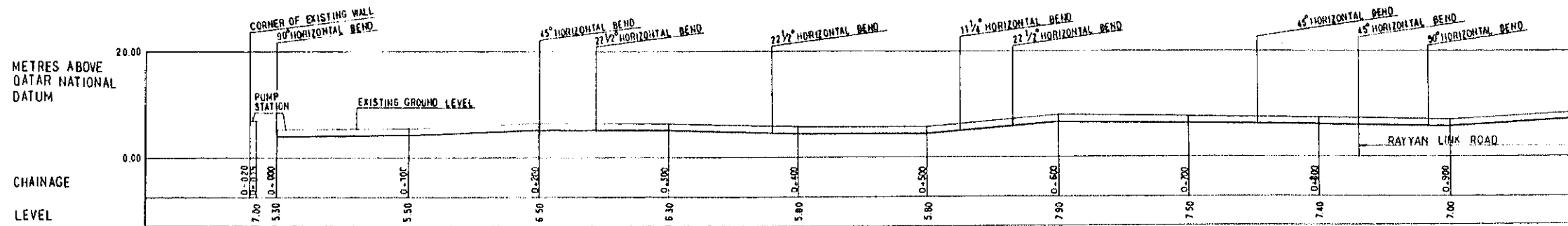

VERTICAL SCALE 1:500 HORIZONTAL SCALE 1:2000

STATE OF QATAR		SCALE
THE STUDY ON DRAINAGE IMPROVEMENT PLAN, DOHA CITY		1:100 1:500 1:2000
DISCHARGE PIPE LINE TRANSVERSAL AND LONGITUDINAL SECTIONS (1/10)		DRP 1 4029
JAPAN INTERNATIONAL COOPERATION AGENCY		
DRAWN	CHECKED	APPROVED



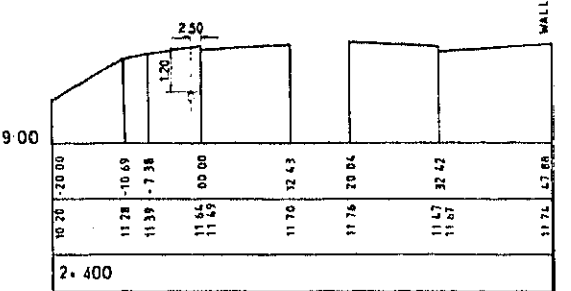
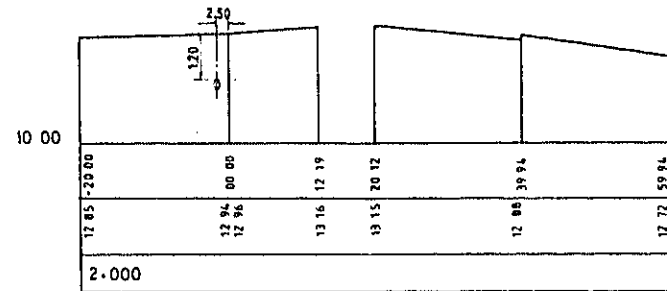
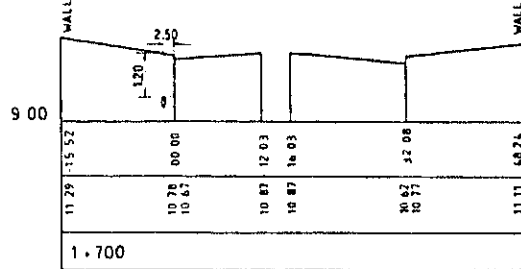
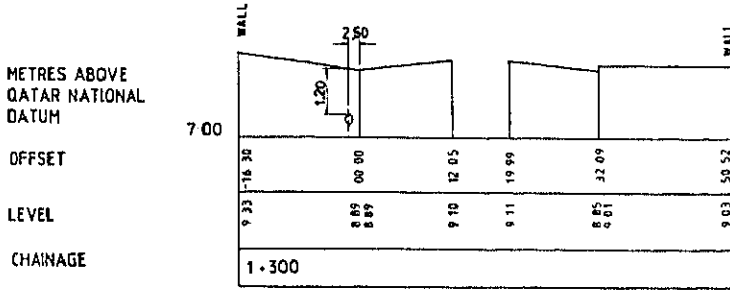
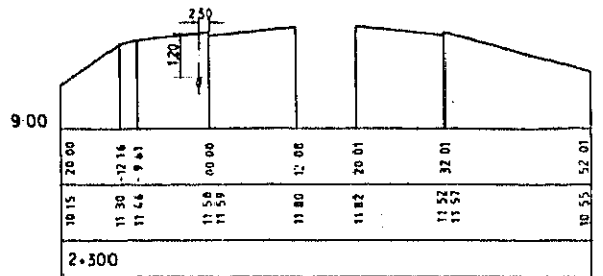
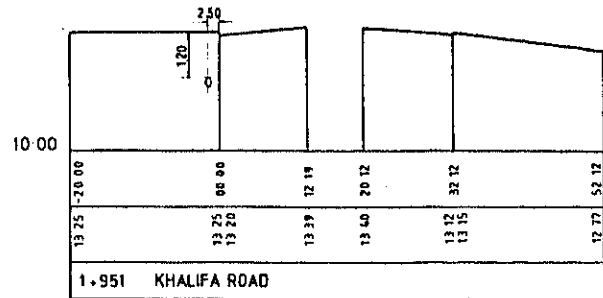
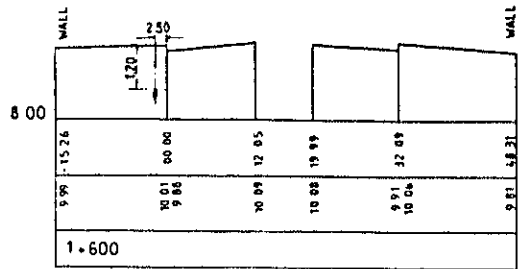
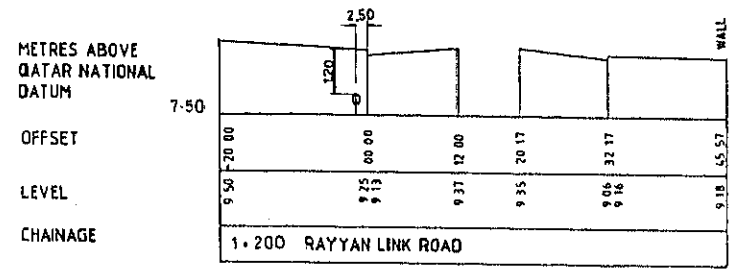

Vertical Scale 1:100 Horizontal Scale 1:500

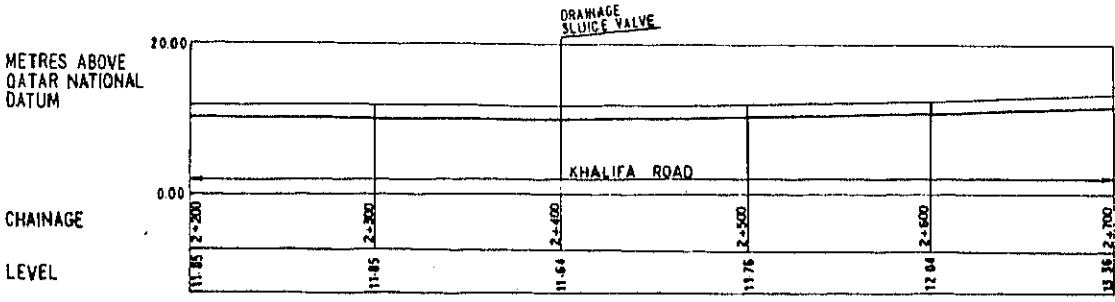
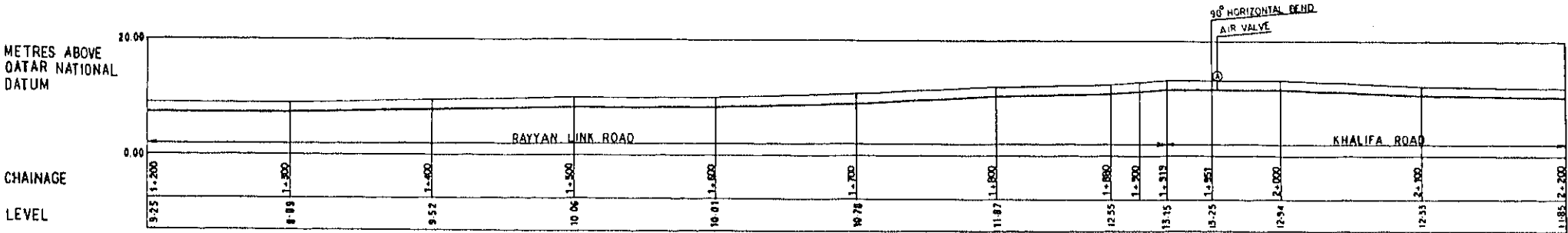
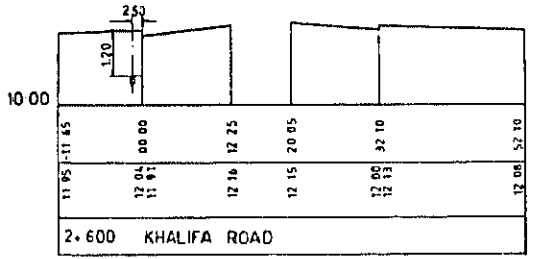
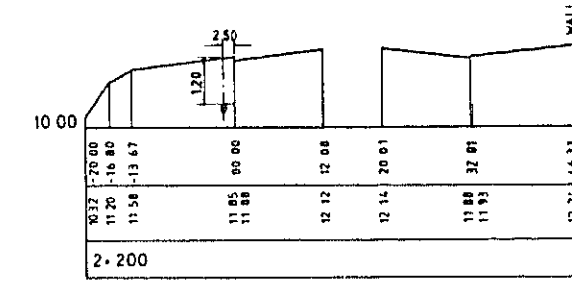
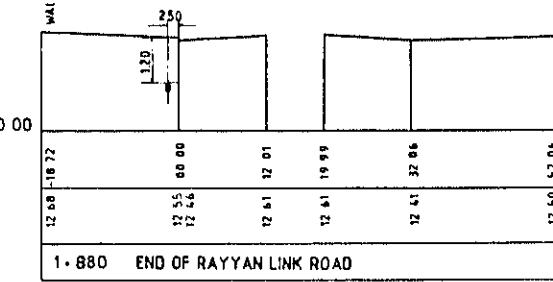
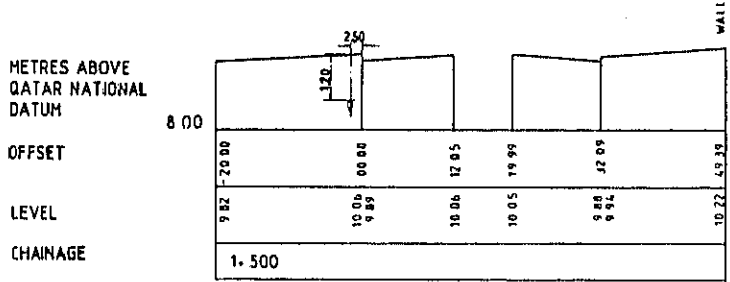
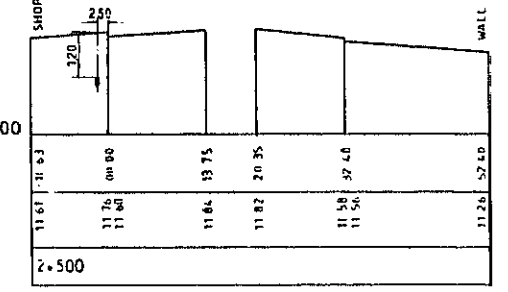
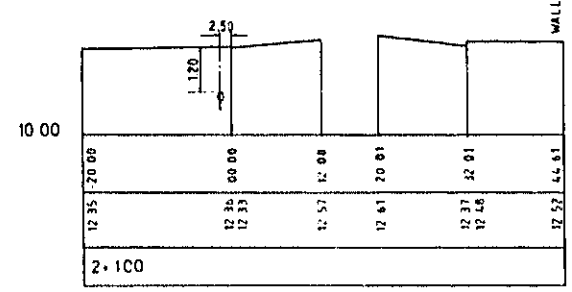
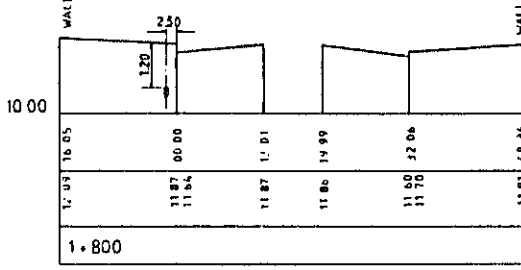
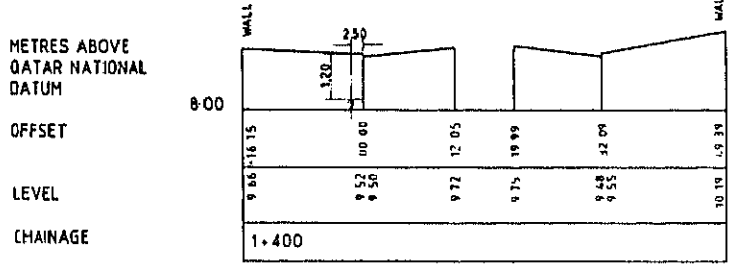

VERTICAL SCALE 1:500 HORIZONTAL SCALE 1:2000

STATE OF QATAR		SCALE
THE STUDY ON DRAINAGE IMPROVEMENT PLAN, DOHA CITY		1: 100 1: 500 1: 2000
DISCHARGE PIPE LINE TRANSVERSAL AND LONGITUDINAL SECTIONS (2/10)		DRP 4030
JAPAN INTERNATIONAL COOPERATION AGENCY		
DRAWN	CHECKED	APPROVED

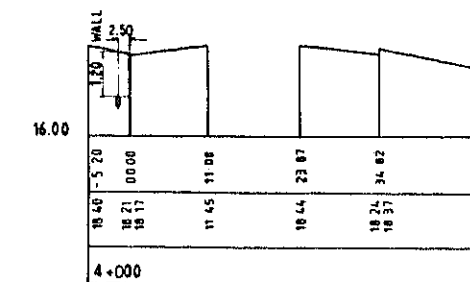
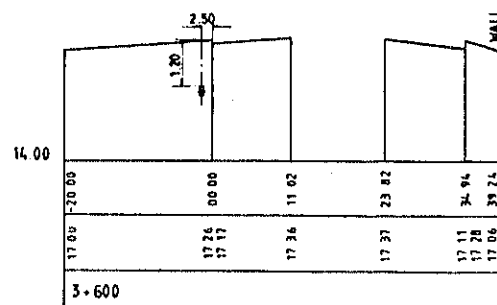
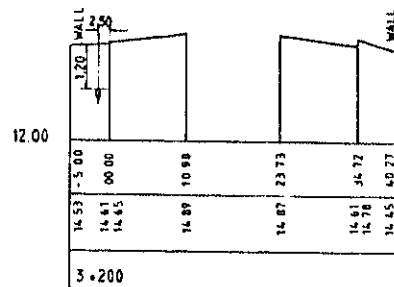
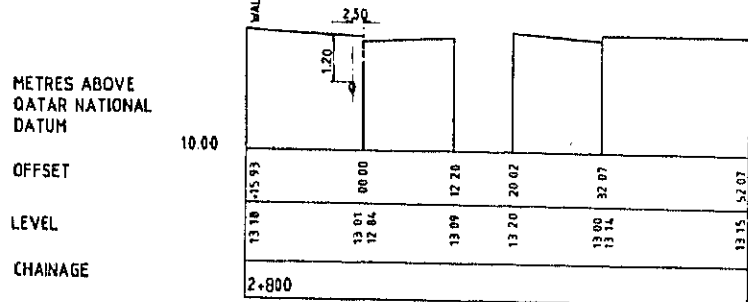
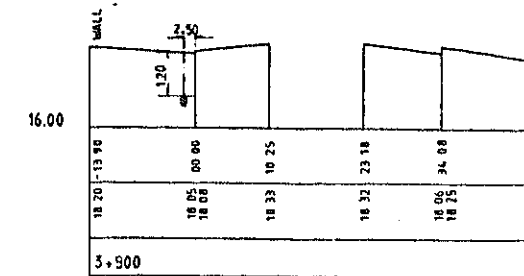
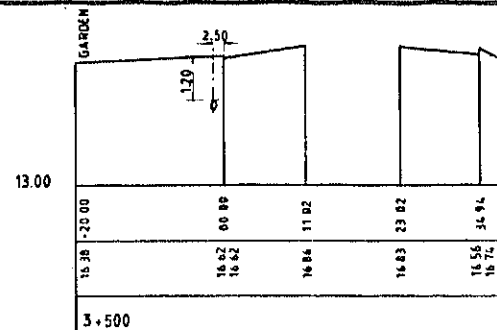
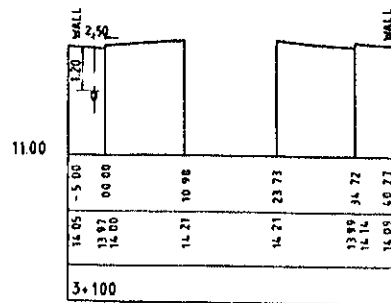
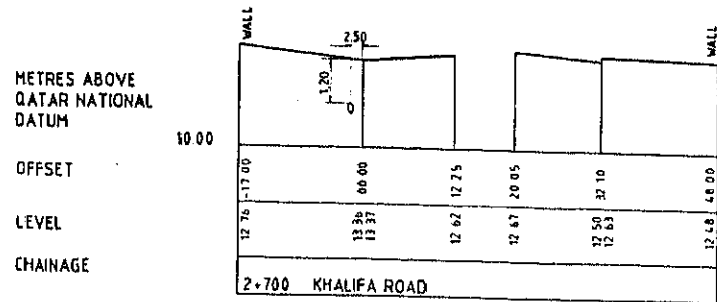

Vertical Scale 1:100 Horizontal Scale 1:500

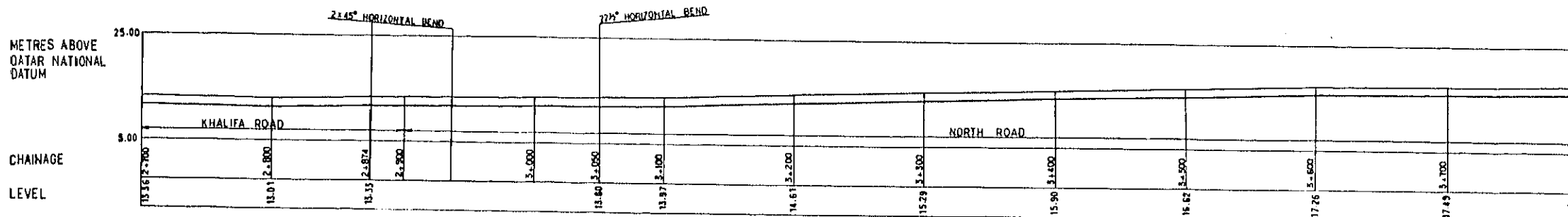
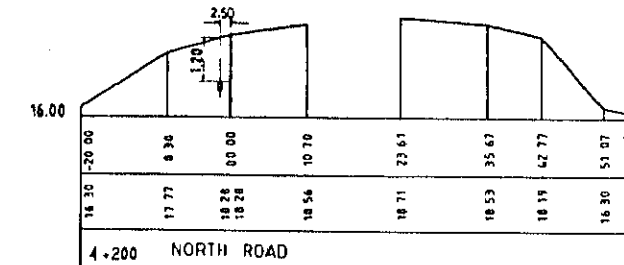
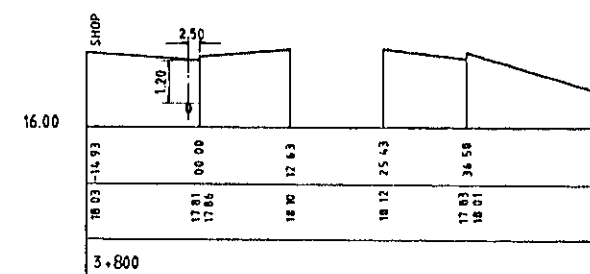
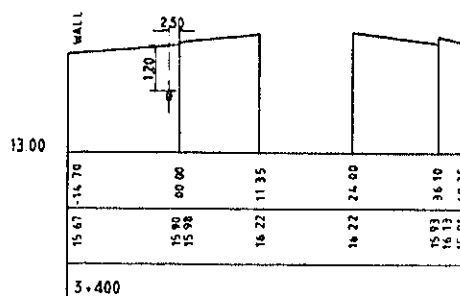
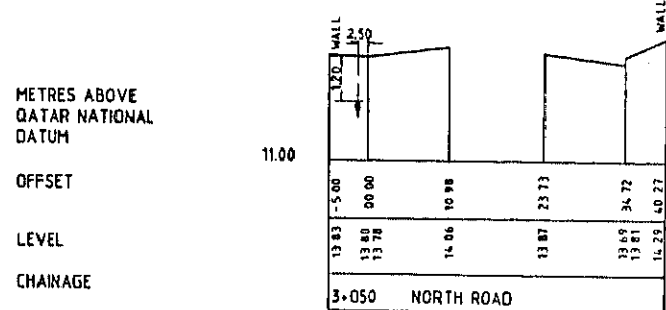
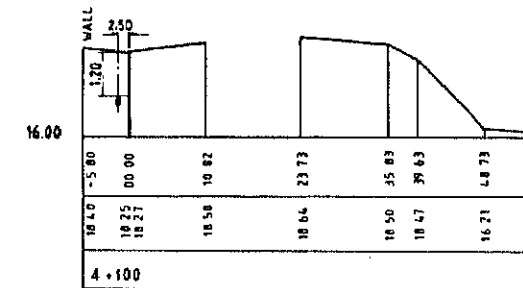
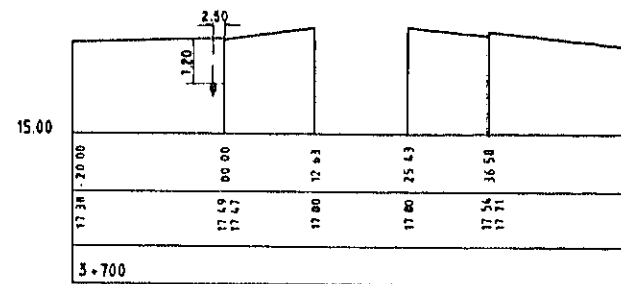
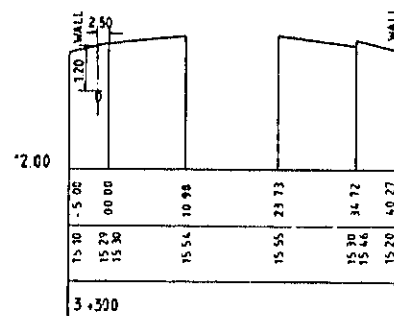
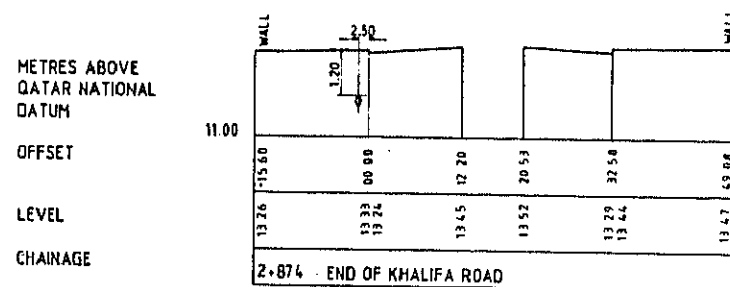

VERTICAL SCALE 1:500 HORIZONTAL SCALE 1:2000

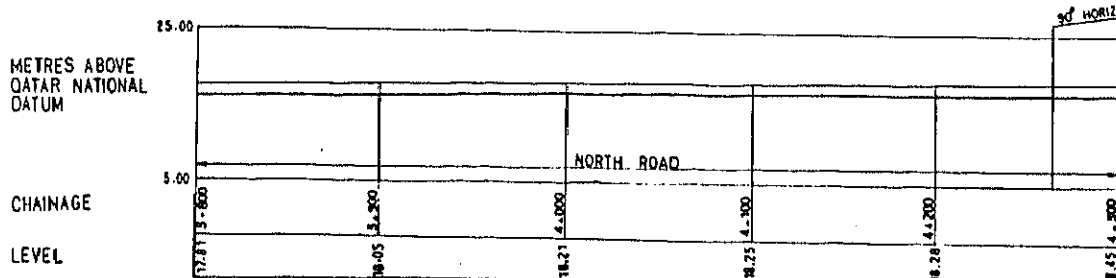

STATE OF QATAR		SCALE
THE STUDY ON DRAINAGE IMPROVEMENT PLAN, DOHA CITY		1:100 1:500 1:2000
DISCHARGE PIPE LINE TRANSVERSAL AND LONGITUDINAL SECTIONS (3/10)		DRP 4031
JAPAN INTERNATIONAL COOPERATION AGENCY		
DRAWN	CHECKED	APPROVED



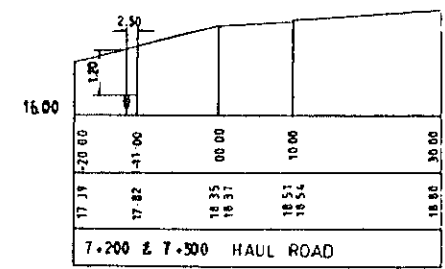
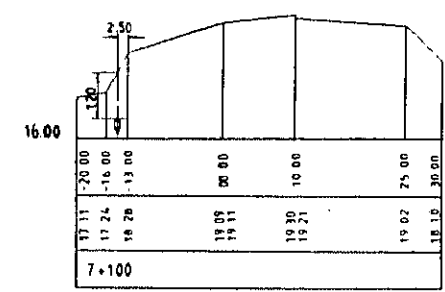
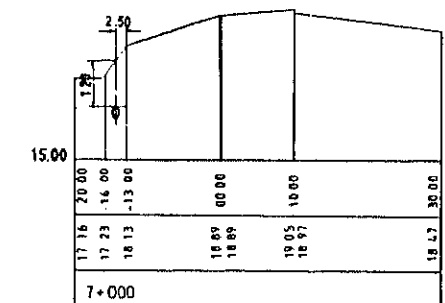
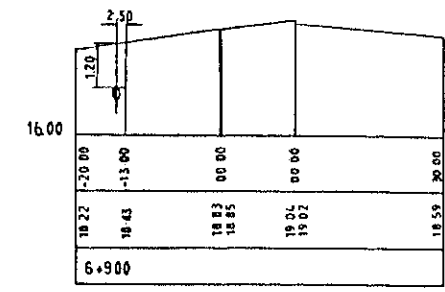
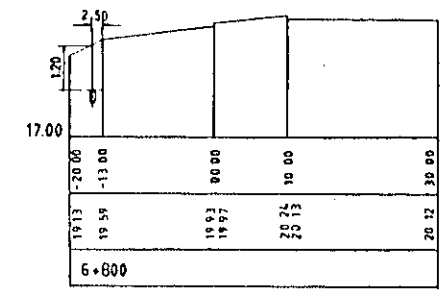
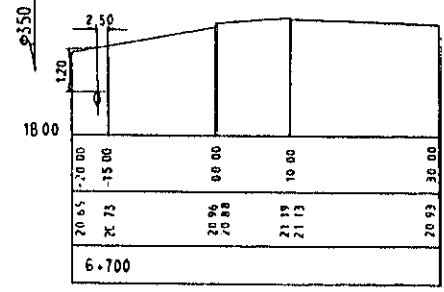
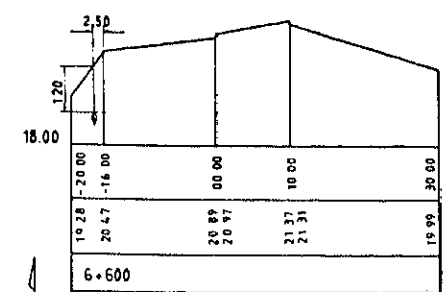
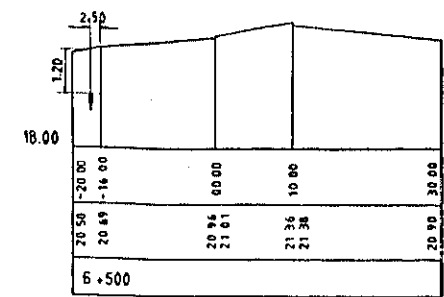
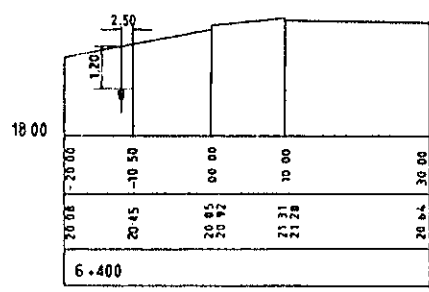
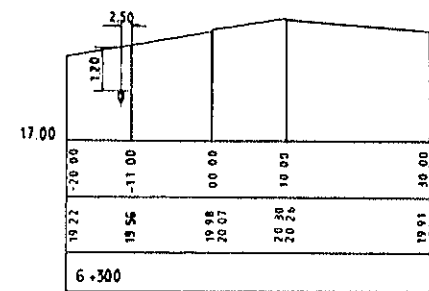
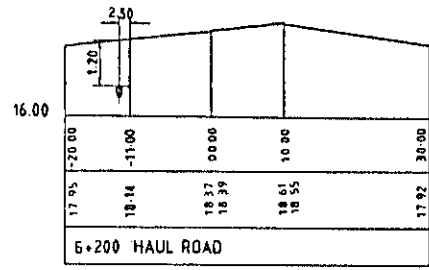
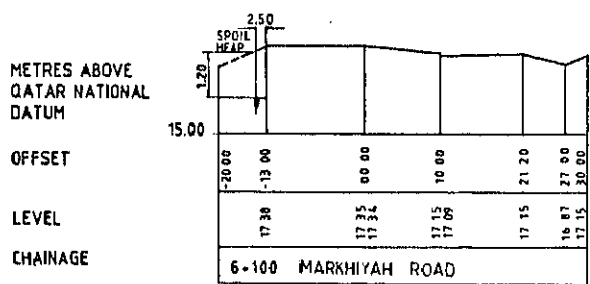
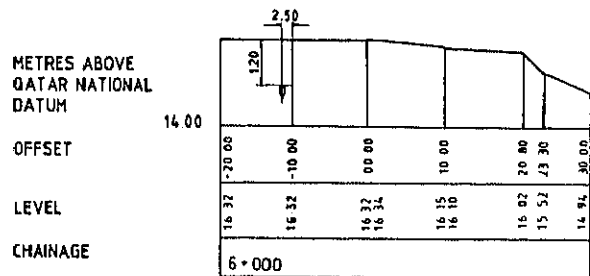
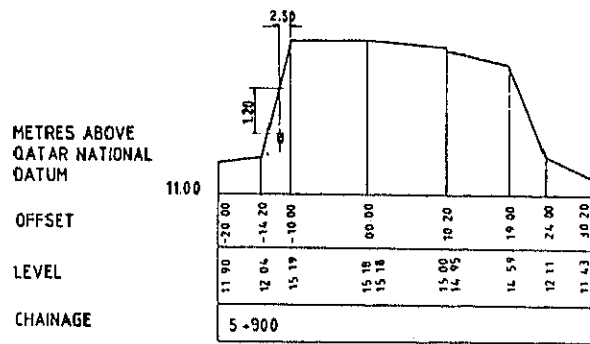
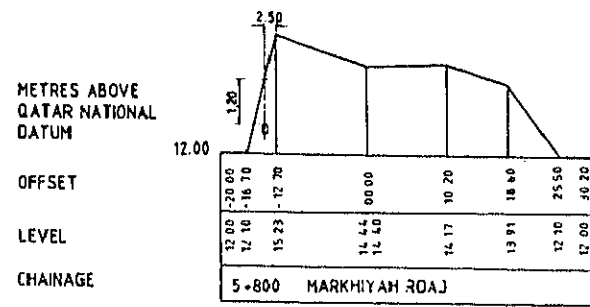

Vertical Scale 1:100 Horizontal Scale 1:500

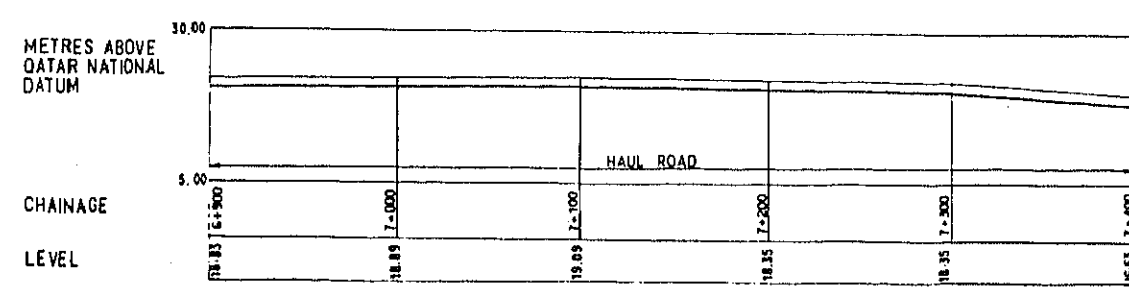
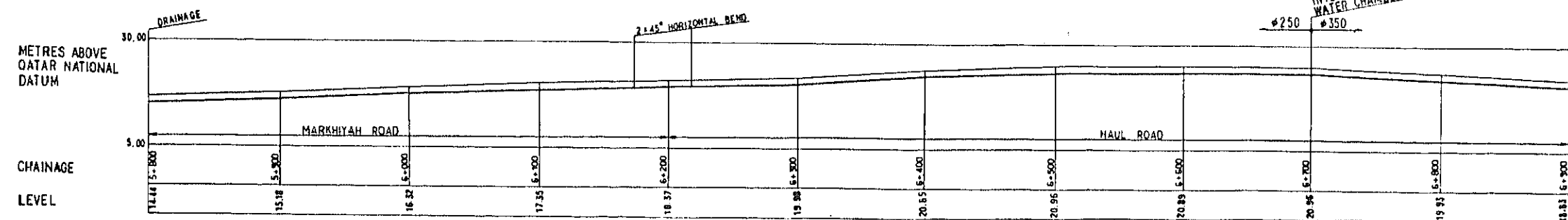

VERTICAL SCALE 1:500 HORIZONTAL SCALE 1:2000

STATE OF QATAR		SCALE
THE STUDY ON DRAINAGE IMPROVEMENT PLAN, DOHA CITY		1 100 1 500 1 2000
DISCHARGE PIPE LINE TRANSVERSAL AND LONGITUDINAL SECTIONS (5/10)		DRP 1 4033
JAPAN INTERNATIONAL COOPERATION AGENCY		
DRAWN	CHECKED	APPROVED
<i>[Signature]</i>	<i>[Signature]</i>	<i>[Signature]</i>

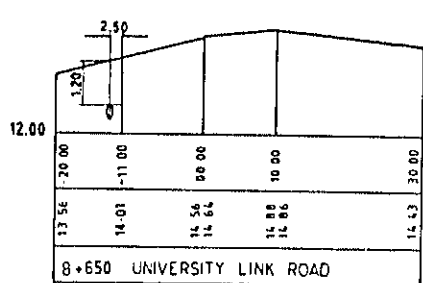
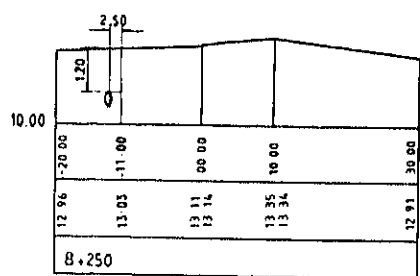
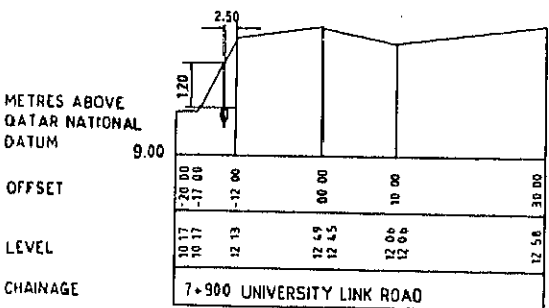
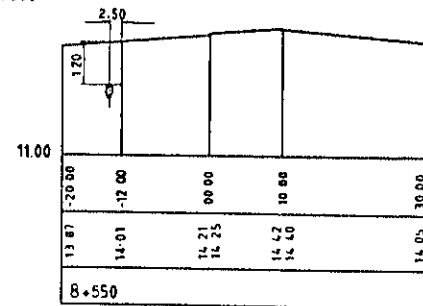
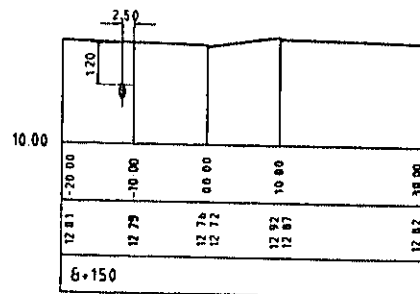
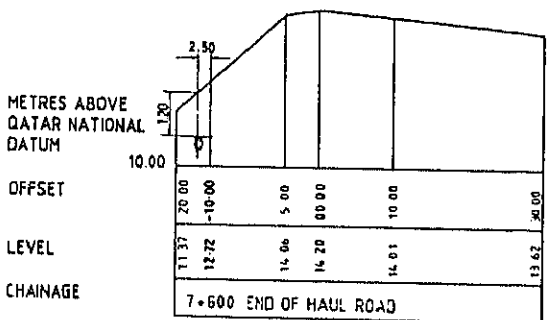
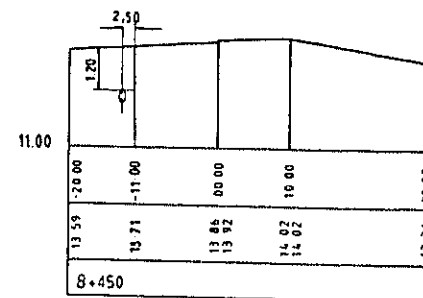
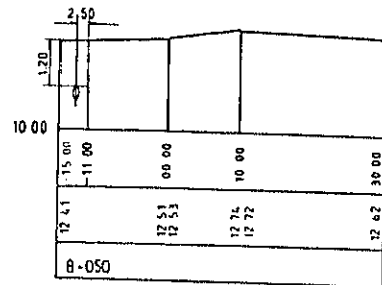
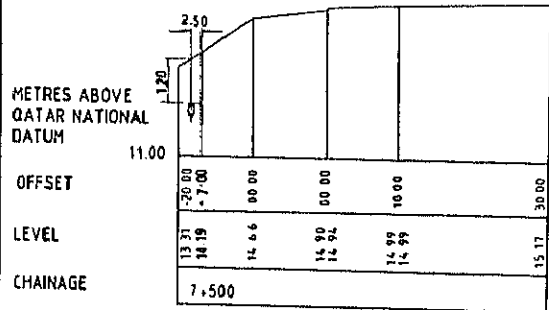
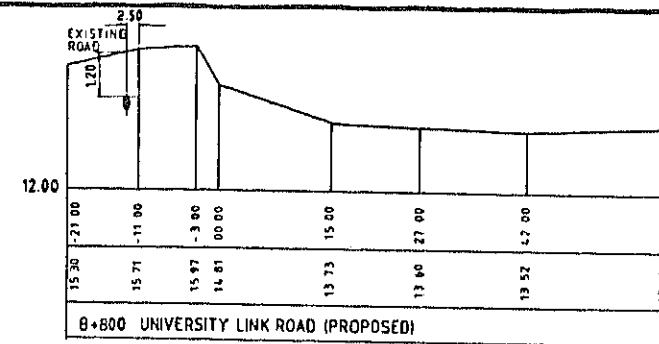
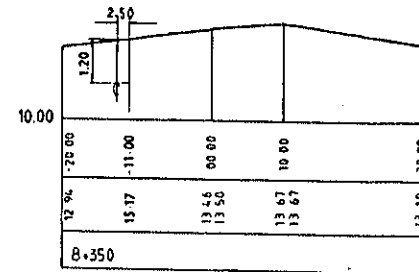
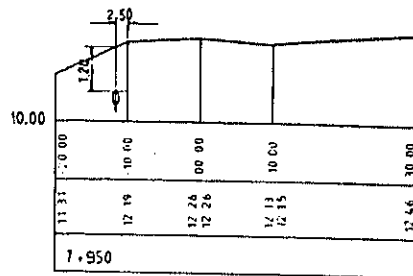
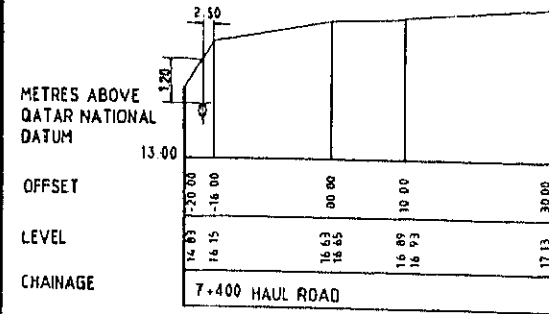

Vertical Scale 1:100 Horizontal Scale 1:500

VERTICAL SCALE 1:500 HORIZONTAL SCALE 1:2000

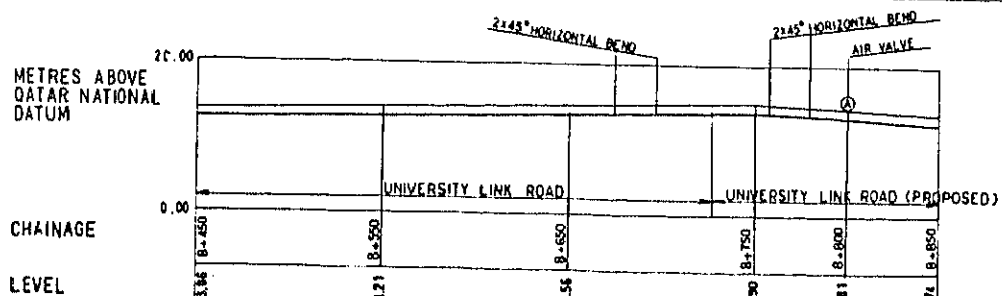
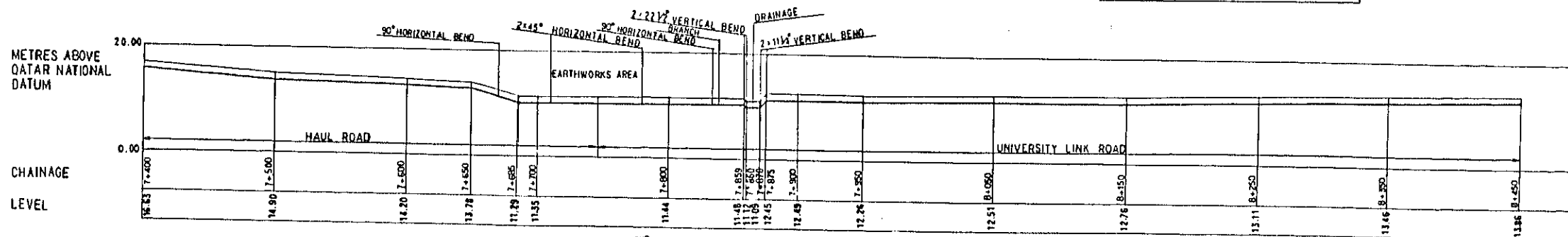

STATE OF QATAR		SCALE
THE STUDY ON DRAINAGE		1:100
IMPROVEMENT PLAN, DOHA CITY		1:500
		1:2000
DISCHARGE PIPE LINE		DRP
TRANSVERSAL AND LONGITUDINAL		I
SECTIONS (6/10)		4034
JAPAN INTERNATIONAL COOPERATION AGENCY		
DRAWN	CHECKED	APPROVED



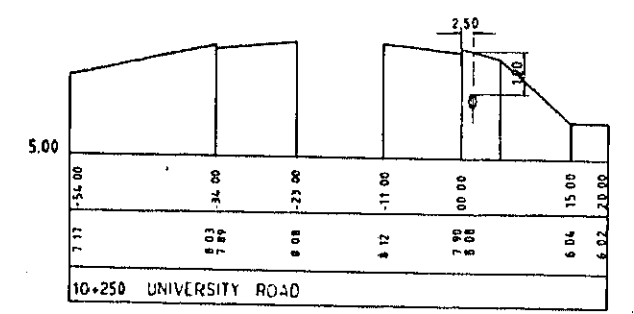
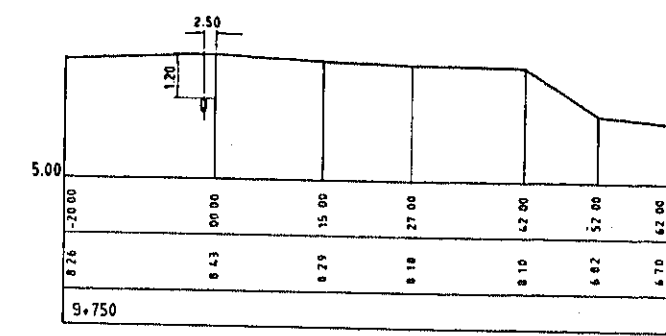
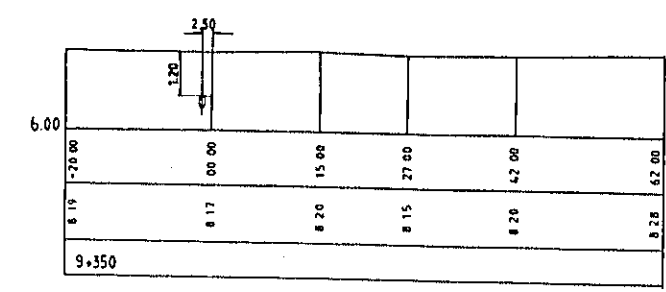
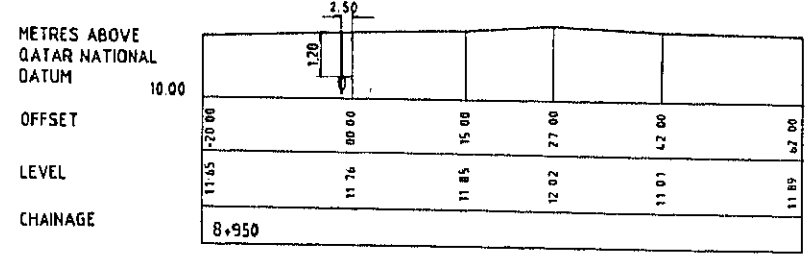
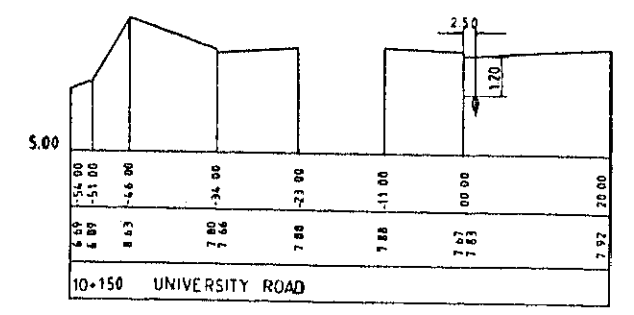
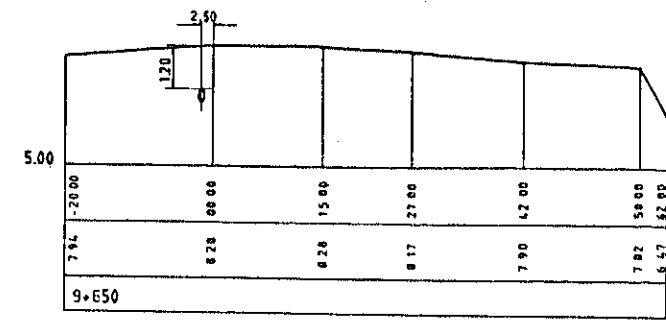
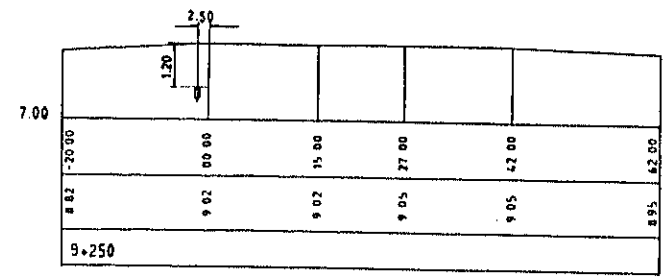
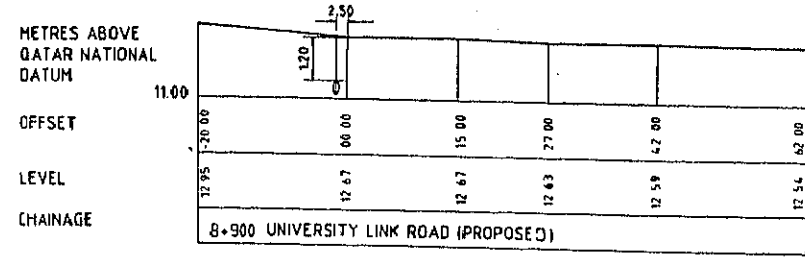

Vertical Scale 1:100 Horizontal Scale 1:500

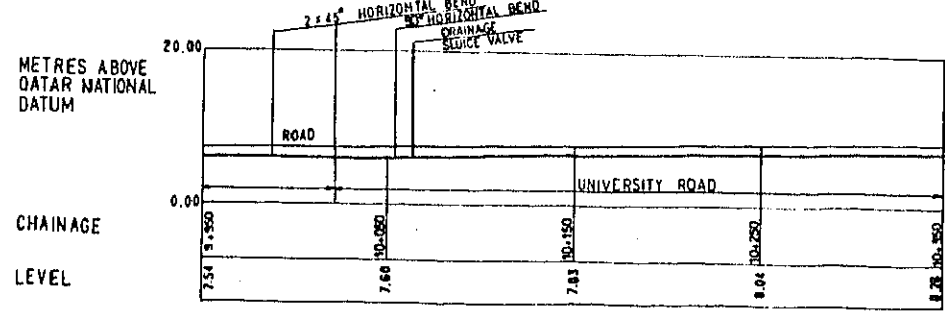
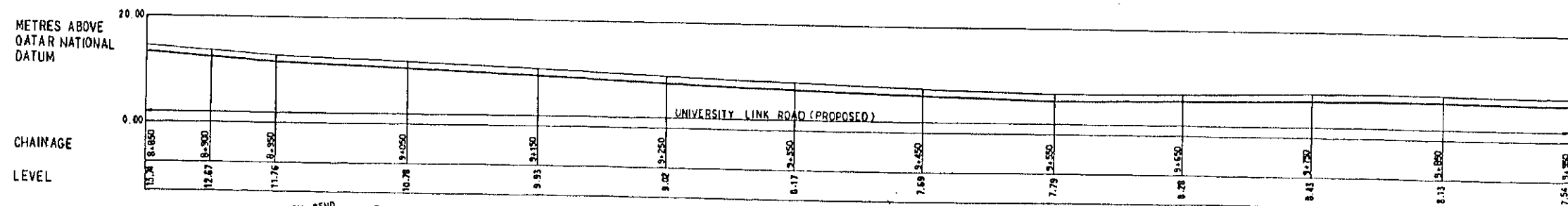
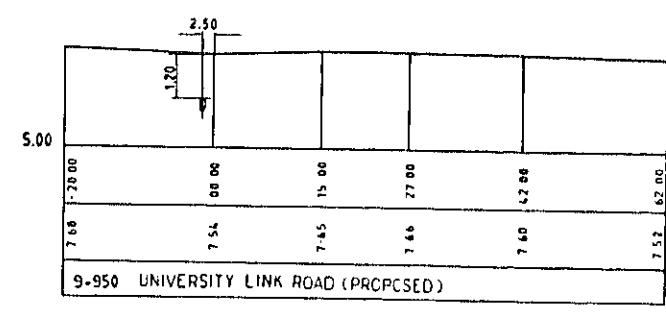
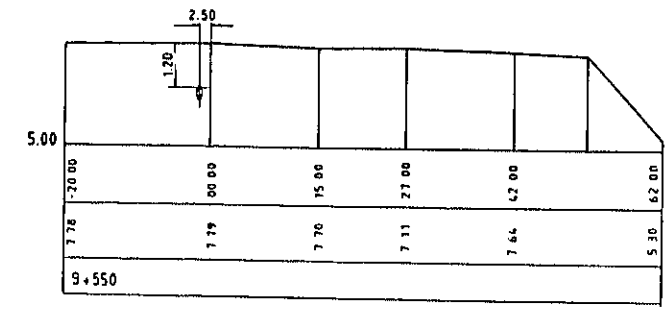
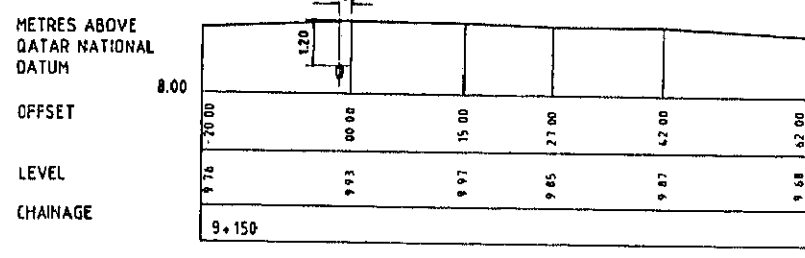
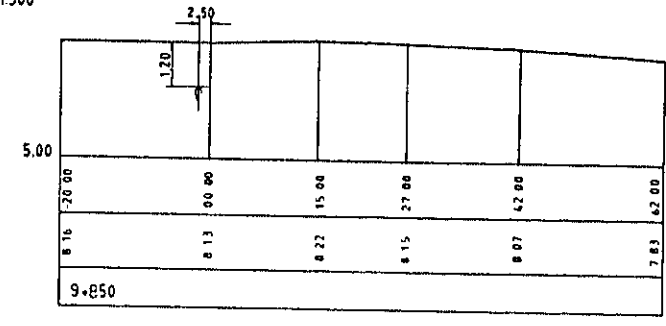
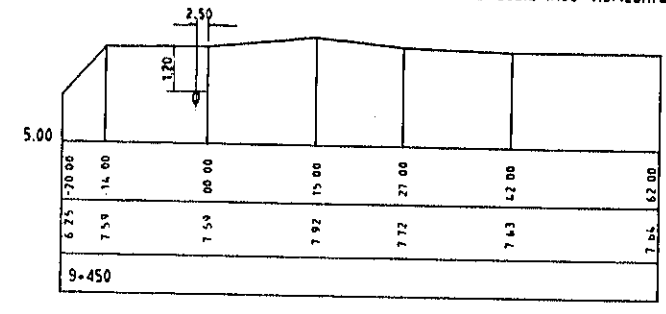
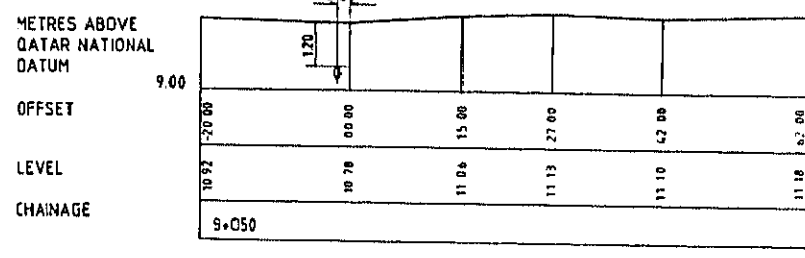

VERTICAL SCALE 1:500 HORIZONTAL SCALE 1:2000

STATE OF QATAR		SCALE
THE STUDY ON DRAINAGE IMPROVEMENT PLAN, DOHA CITY		1:100 1:500 1:2000
DISCHARGE PIPE LINE TRANSVERSAL AND LONGITUDINAL SECTIONS (7/10)		DRP 1 4035
JAPAN INTERNATIONAL COOPERATION AGENCY		
DRAWN	CHECKED	APPROVED

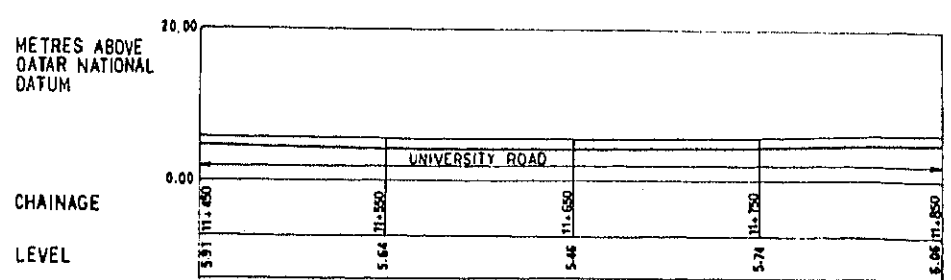
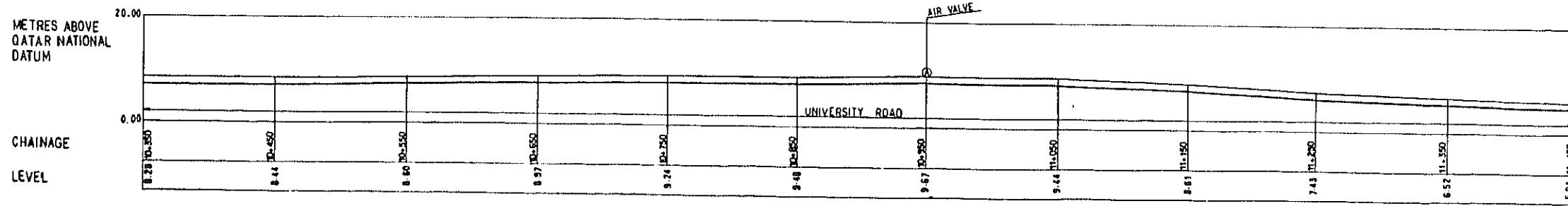
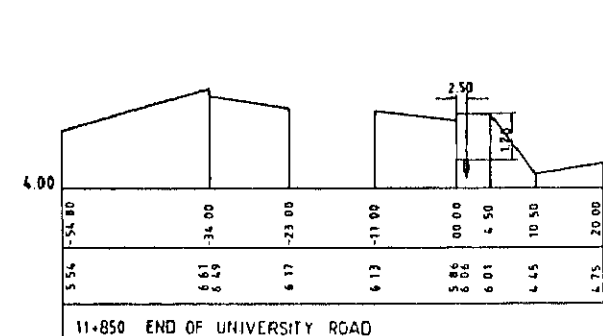
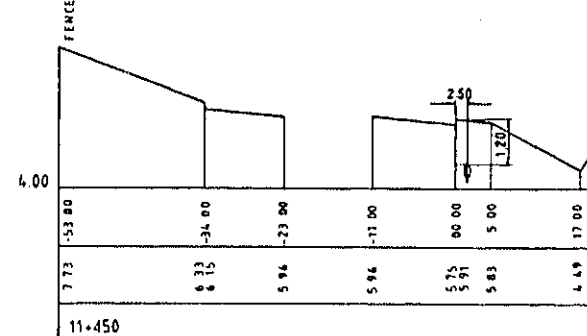
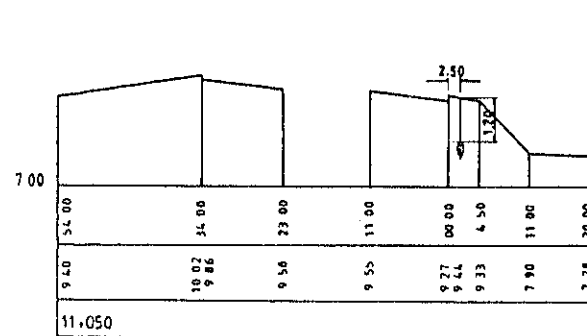
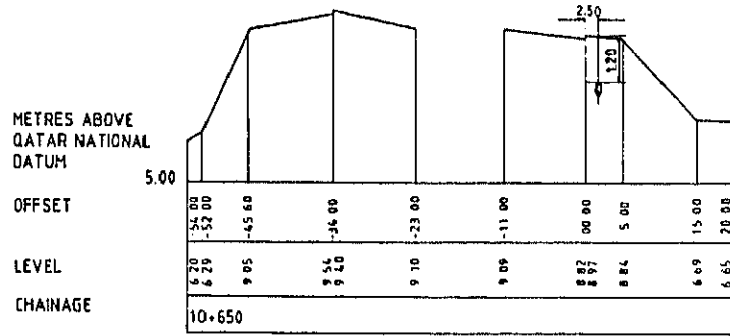
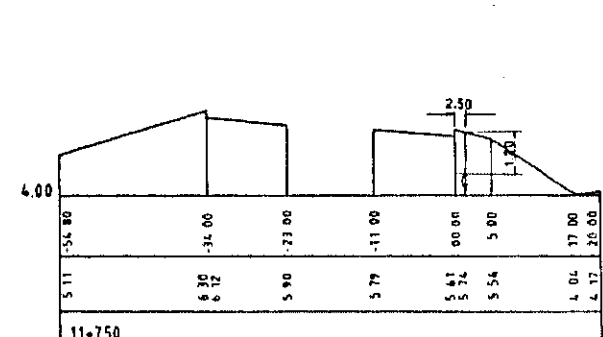
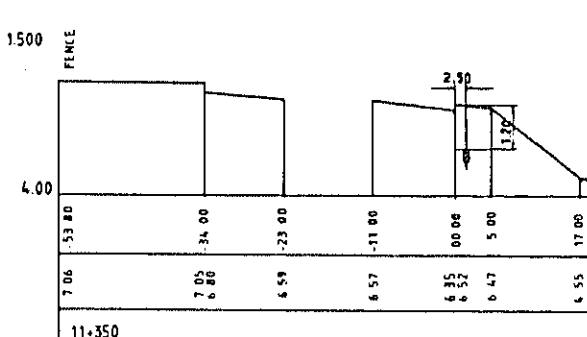
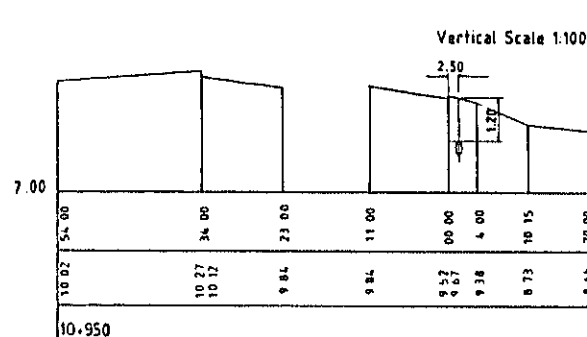
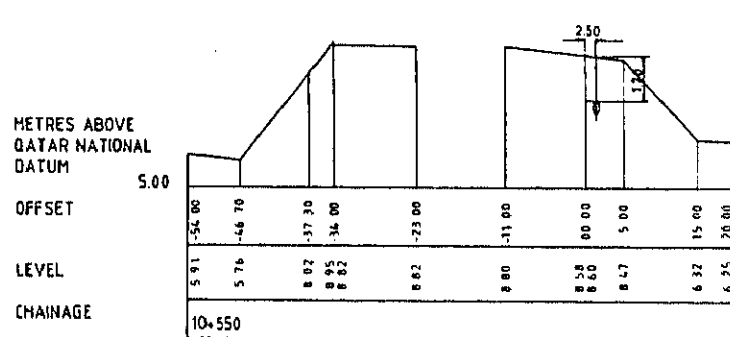
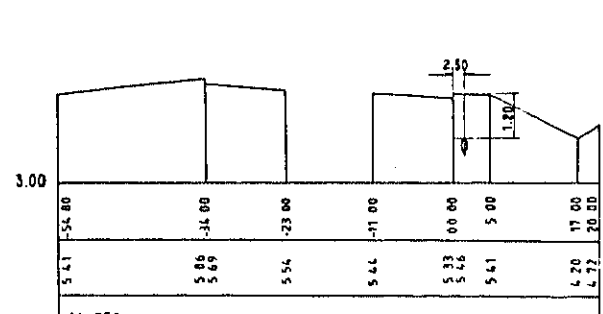
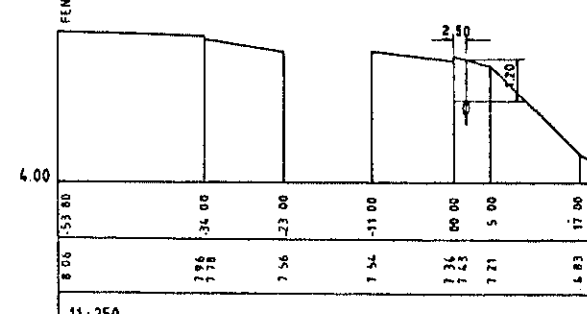
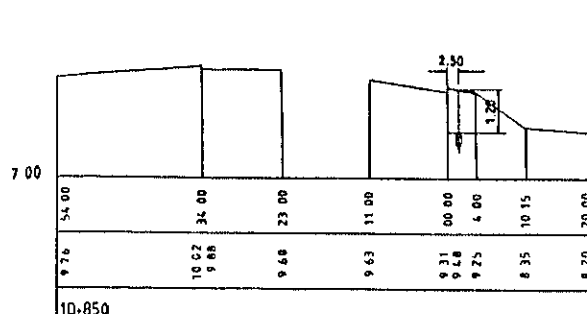
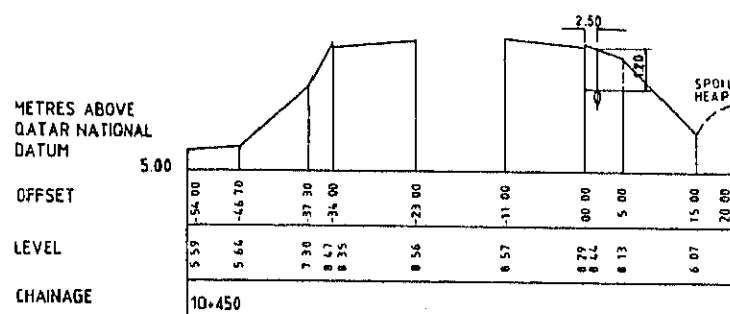
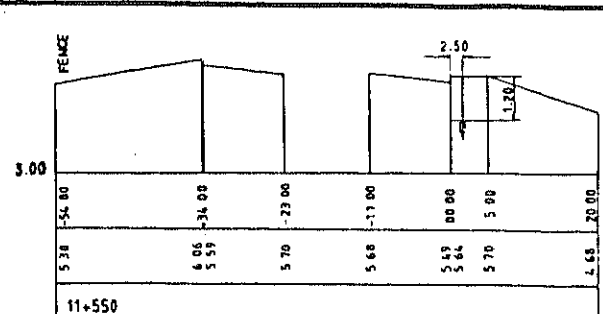
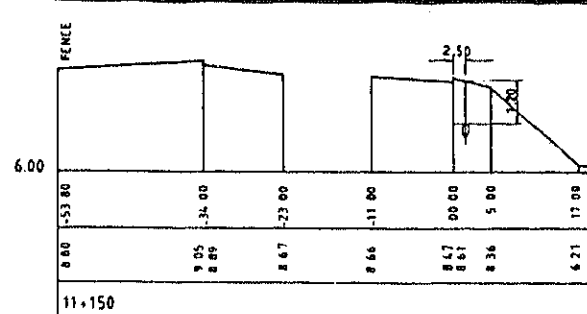
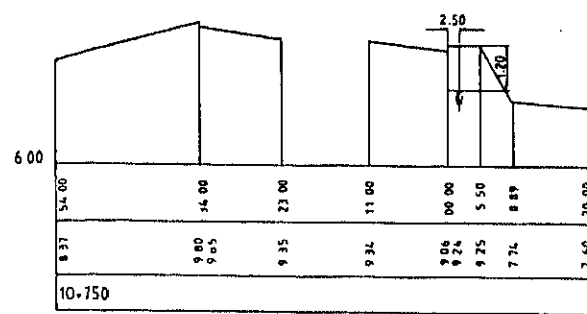
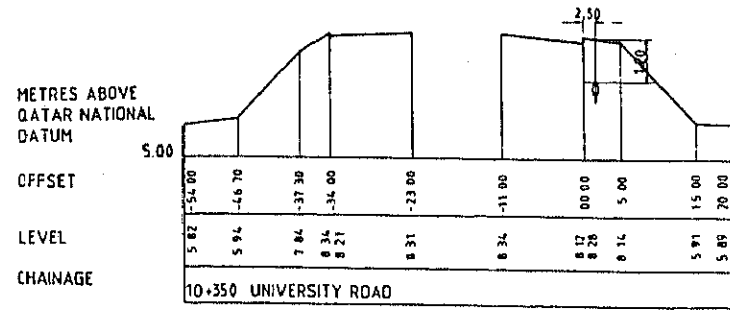

VERTICAL SCALE 1:500 HORIZONTAL SCALE 1:2000

STATE OF QATAR		SCALE
THE STUDY ON DRAINAGE IMPROVEMENT PLAN, DOHA CITY		1:100
		1:500
		1:2000
DISCHARGE PIPE LINE TRANSVERSAL AND LONGITUDINAL SECTIONS (8/10)		DRP 1 4036
JAPAN INTERNATIONAL COOPERATION AGENCY		
DRAWN	CHECKED	APPROVED

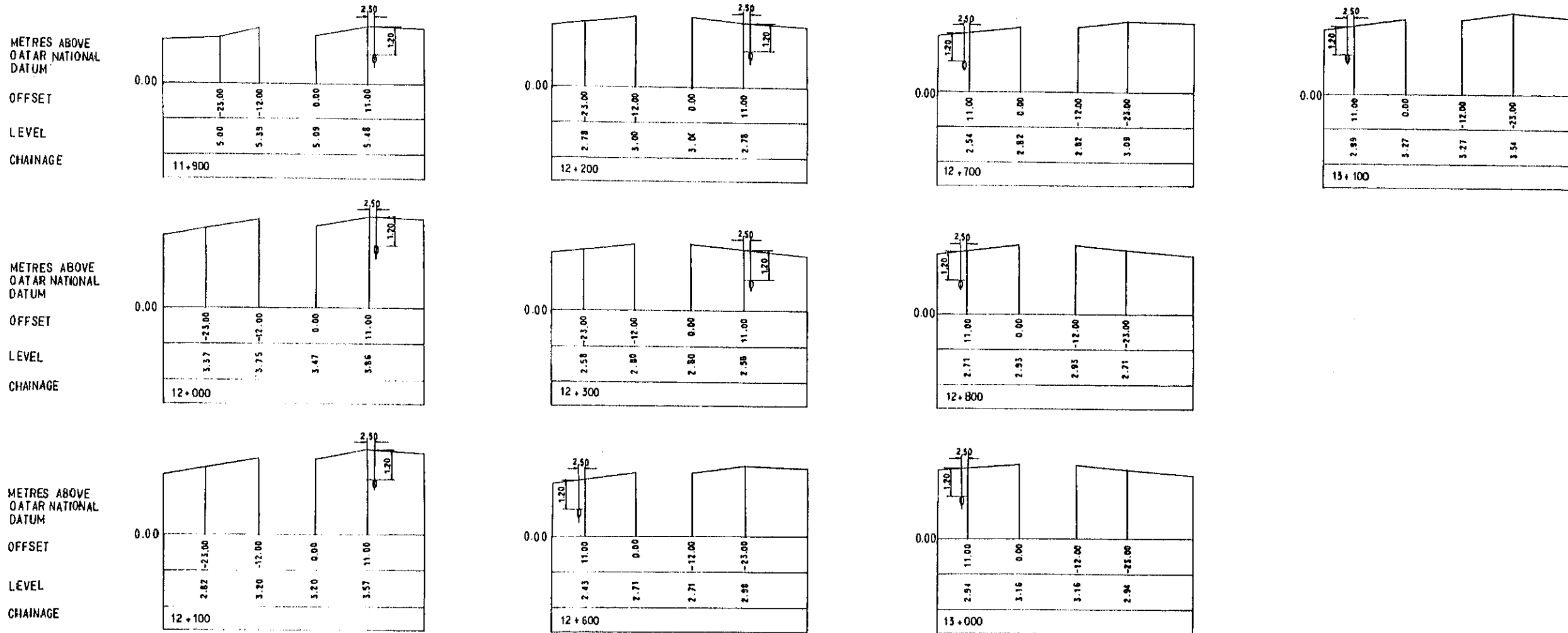

Vertical Scale 1:100 Horizontal Scale 1:500

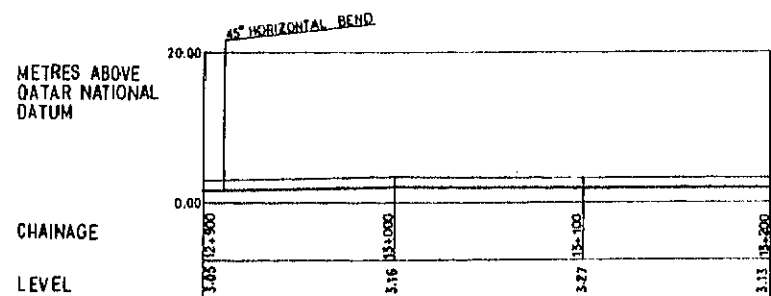
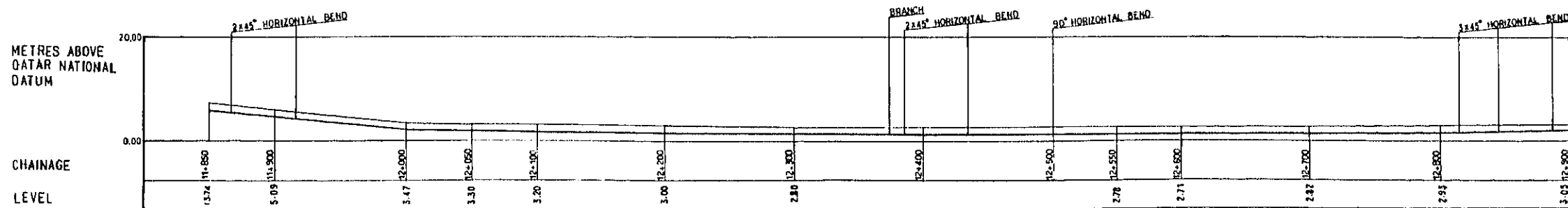

VERTICAL SCALE 1:500 HORIZONTAL SCALE 1:2000

STATE OF QATAR		SCALE
THE STUDY ON DRAINAGE IMPROVEMENT PLAN, DOHA CITY		1:100 1:500 1:2000
DISCHARGE PIPE LINE TRANSVERSAL AND LONGITUDINAL SECTIONS (9/10)		DRP 1 4037
JAPAN INTERNATIONAL COOPERATION AGENCY		
DRAWN	CHECKED	APPROVED

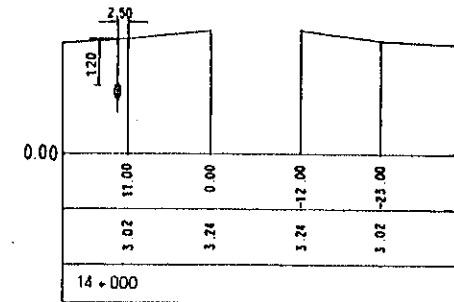
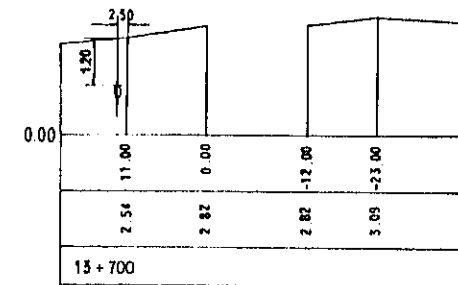
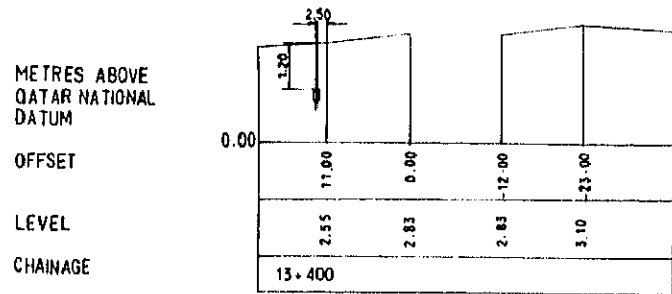
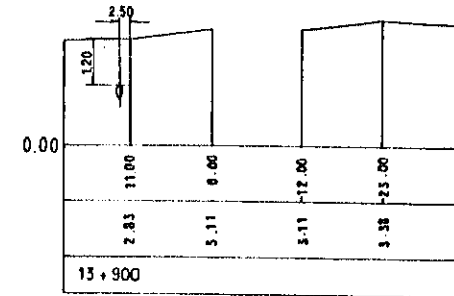
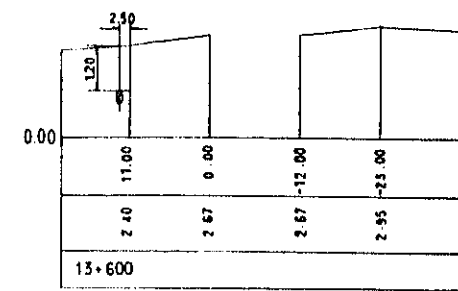
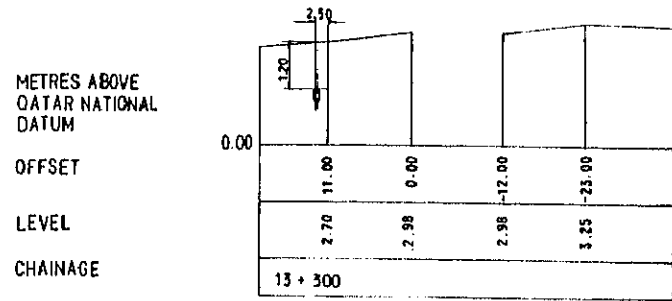
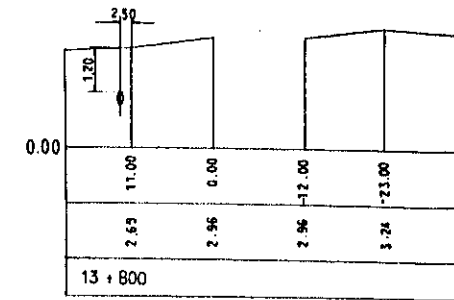
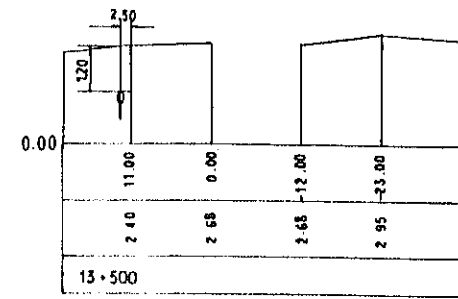
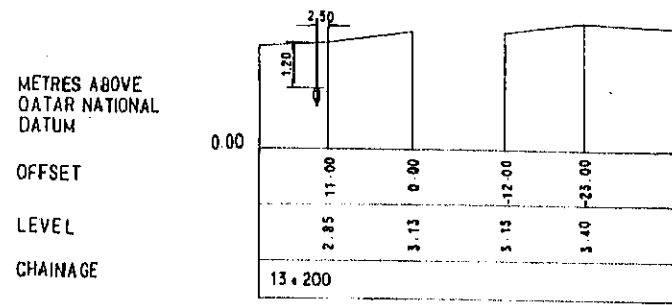

Vertical Scale 1:100 Horizontal Scale 1:500

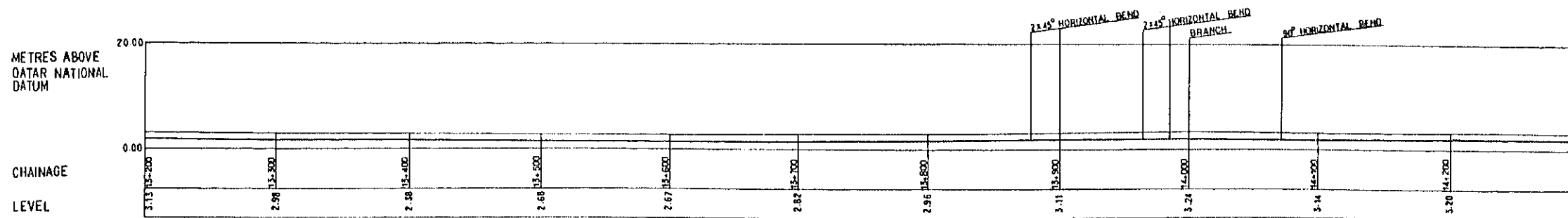

VERTICAL SCALE 1:500 HORIZONTAL SCALE 1:2000

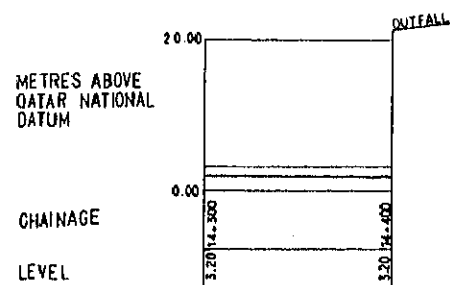

STATE OF QATAR		SCALE
THE STUDY ON DRAINAGE IMPROVEMENT PLAN, DOHA CITY		1:100 1:500 1:2000
DISCHARGE PIPE LINE TRANSVERSAL AND LONGITUDINAL SECTIONS (10/10)		DRP 1 4038
JICA JAPAN INTERNATIONAL COOPERATION AGENCY		
DRAWN	CHECKED	APPROVED











JICA