

THE DEMOCRATIC SOCIALIST
REPUBLIC OF SRI LANKA
FEASIBILITY STUDY REPORT
ON
TELEVISION BROADCASTING
NETWORK CONSTRUCTION PROJECT

October 1978

JAPAN INTERNATIONAL COOPERATION AGENCY

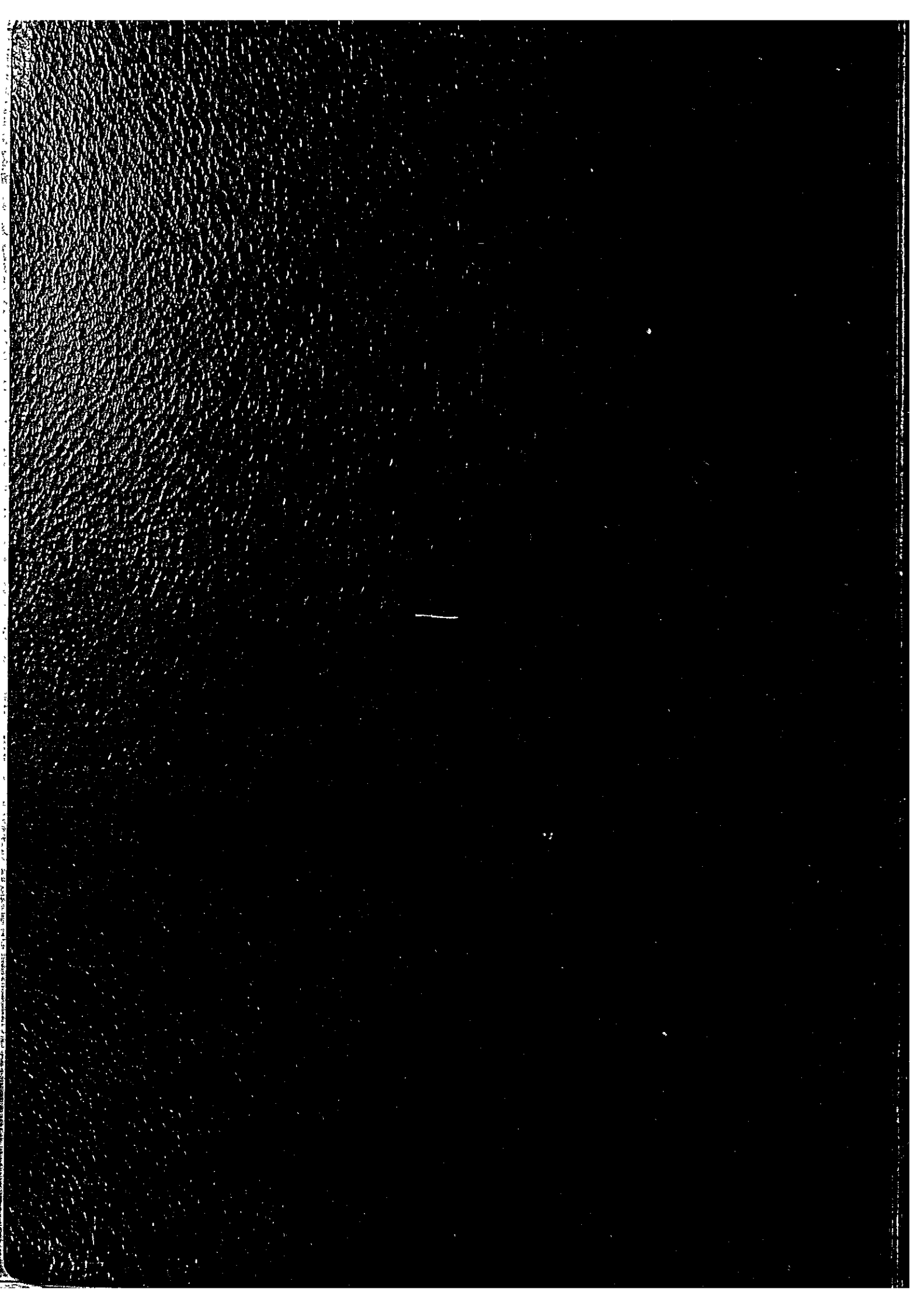

**THE DEMOCRATIC SOCIALIST
REPUBLIC OF SRI LANKA
FEASIBILITY STUDY REPORT
ON
TELEVISION BROADCASTING
NETWORK CONSTRUCTION PROJECT**

JICA LIBRARY



1026717E7J

October 1978

JAPAN INTERNATIONAL COOPERATION AGENCY

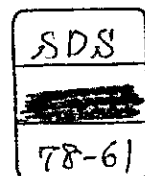

國際協力事業団	
前 55.6.15	120
後 54.5.16	79
登録No. 04999	SDS

Preface

In response to a request of the Government of the Democratic Socialist Republic of Sri Lanka, the Government of Japan as part of its technical cooperation programme to the Government of Sri Lanka decided to make a Feasibility Study on the nationwide television broadcasting network construction project which constitutes part of Sri Lanka's national development plan, and the Japan International Cooperation Agency (JICA) executed the study.

The JICA dispatched to Sri Lanka a survey team of 10 experts headed by Mr. Sadao Takemura, Special Assistant to the Director General of the Radio Regulatory Bureau of the Ministry of Posts and Telecommunications, for conducting a feasibility study for a period from May 4th to June 12, 1978.

As a results of the field survey, the team submitted an interim report to the Government of Sri Lanka.

After further studies in Japan of the findings of the survey this final report has been prepared.

I sincerely hope that this report will contribute to the establishment of the television broadcasting network in the Democratic Socialist Republic of Sri Lanka, to its social and economic development and also to the promotion of freindship between Sri Lanka and Japan.

I would like to express my gratitude to those concerned of the Government of the Democratic Socialist Republic of Sri Lanka for their full cooperation extended to the team.

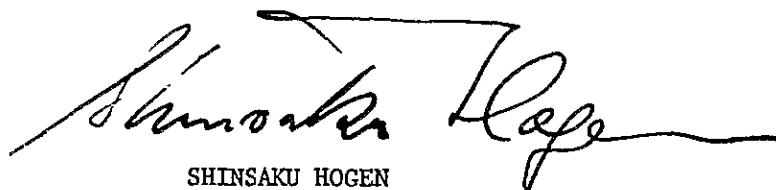

SHINSAKU HOGEN

President
Japan International Cooperation Agency



A visit of courtesy

From left, Ambassador,
President, Leader of the
Survey Team

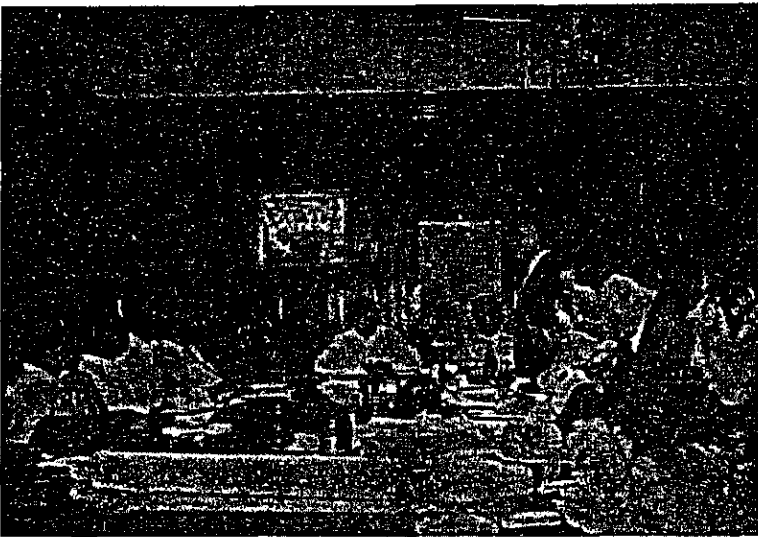

Meeting with the Hon:
Ministor Information and
Broadcasting

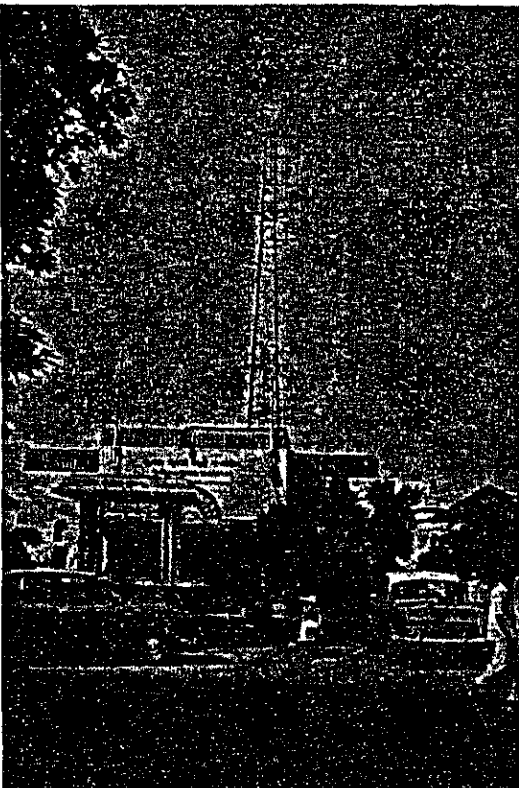

(SLBC Radio Broadcasting House)

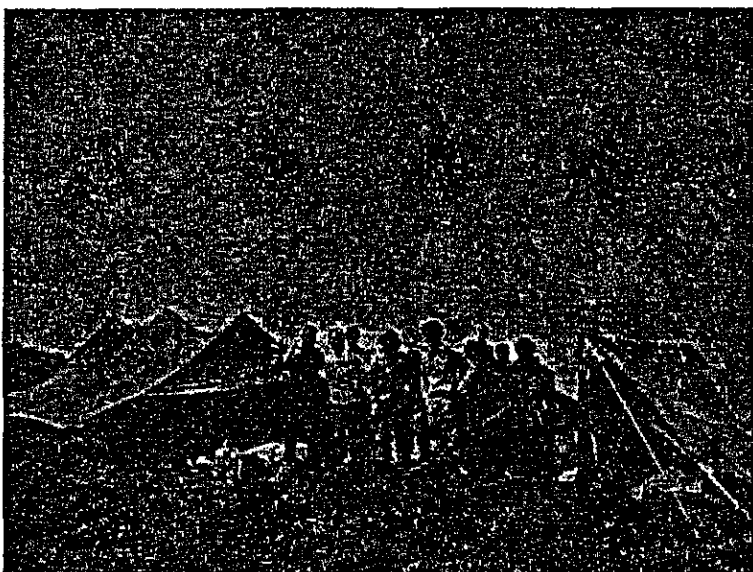

Radio Propagation Test on
the Top of Mt. Pidurutalagala

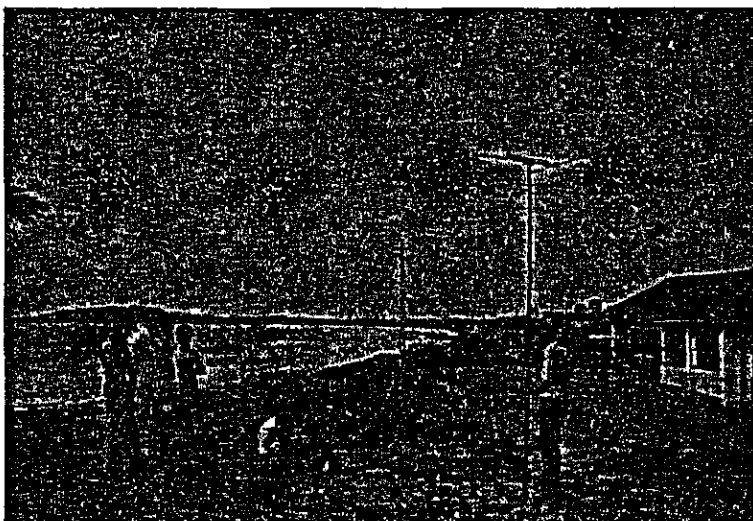

Radio Propagation Test
on the Field

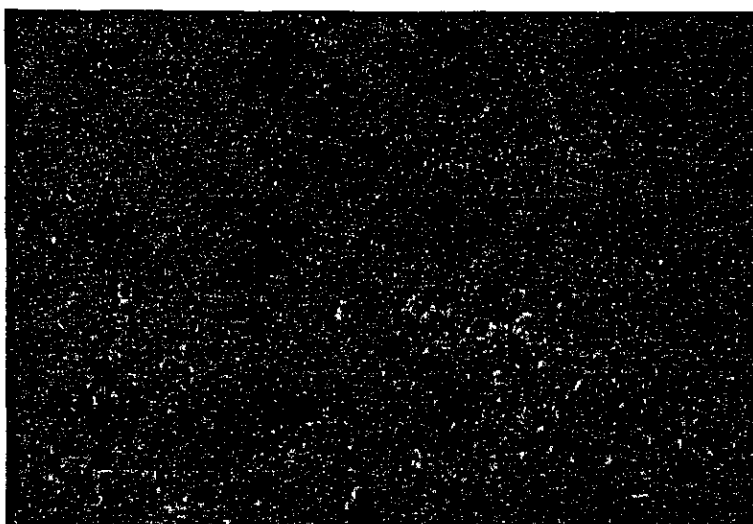

Tea Garden

CONTENTS

PART I SUMMARY

	page
SECTION 1 INTRODUCTION	
1-1 Purpose of Survey	1
1-2 Course of Survey	1
1-3 Scope of Survey	1
1-4 Survey Team Members	1
1-5 Survey Programme	2
SECTION 2 CONCLUSION AND RECOMMENDATIONS	
2-1 Plan for Introduction of Television Broadcasting .	5
2-2 Scale of Broadcasting Network	5
2-3 Channel Plan	5
2-4 Standard Systems of Television Broadcasting	5
2-5 Facility Plan	6
2-6 Implementation Plan	7
2-7 Operation Plan	7
2-8 Popularization Plan of TV Receivers	7
2-9 Personnel and Training Plans	8
2-10 Programme Plan	8
2-11 Economic Evaluation	8

PART II DETAILED DESCRIPTION

SECTION 1 TELEVISION BROADCAST NETWORK INTRODUCTION PLAN	
1-1 Broadcasting Network Plan	11
1-2 Broadcast Programme Transmission Plan	18
1-3 Programme Plan	21
SECTION 2 FACILITY PLAN	
2-1 Broadcast Equipment	48
2-1 Building	54
SECTION 3 IMPLEMENTATION PLAN	
3-1 Construction Schedule	86
3-2 Construction Budget	89
3-3 Maintenance and Operating Expense	92
SECTION 4 OPERATION PLAN	
4-1 Organization and Management	94
4-2 Popularization Plan	95

	Page
4-3 Personnel Training	101
SECTION 5 ECONOMIC EVALUATION	106

PART I SUMMARY

SECTION 1 INTRODUCTION

1-1 Purpose of Survey

To make a feasibility study for the nationwide television broadcasting network construction project in Sri Lanka at the request of the Government of the Democratic Socialist Republic of Sri Lanka.

1-2 Course of Survey

To listen to the officers of the Government of Sri Lanka regarding this project and related items and make a study through on-site survey and analysis of references for determining the feasibility of the project from technical and economic standpoints.

1-3 Scope of Survey

- (1) Confirmation of the terms of reference regarding the Television Broadcasting Network Construction Project
- (2) Study by inspection of existing broadcasting services and facilities
- (3) Study on topographical conditions of proposed transmitting points
- (4) Site planning
- (5) Selection of colour television system
- (6) Settlement of transmitter power, antenna system configuration and antenna characteristics
- (7) Affirmation of service areas
- (8) Frequency allocation
- (9) Programme transmission
- (10) Facility planning
- (11) Preparation of construction schedule
- (12) Cost estimation
- (13) Operation and maintenance planning
- (14) Personnel and training planning
- (15) Programme planning
- (16) Economic evaluation

1-4 Survey Team Members

The survey team was formed with 10 experts including the head. The roles and affiliations of the individual members are:

<u>Name of Member</u>	<u>In Charge of</u>	<u>Affiliated to</u>
Sadao TAKEMURA	Head of the team	Ministry of Posts & Telecommunications
Hiroshi TSUKADA	Site planning	do
Chikanori SAIO	Economic evaluation	do
Takashi OHTSUKA	Site planning	do
Kaoru OKA	System planning	Japan Broadcasting Corporation (NHK)
Hogara CHIBA	Architectural design	do
Hidenori MIYAZAKI	do	do
Hiroshi NAKAMURA	Transmitting facilities	do
Jiro OHNO	Site planning	All Japan Television Service Co., Ltd.
Eiji SAKIHARA	Coordinator	Japan International Cooperation Agency

1-5 Survey Programme

The survey programme was as follows.

- May 4, 1978 The survey team leaves Tokyo at 10:55 (BA38) and arrives in Colombo at 17:50.
- May 5 Salutation to the Japanese Embassy in Sri Lanka and the Ministry of Information and Broadcasting (M/I. & B.).
- May 6 Meeting with Sri Lanka Broadcasting Corporation (SLBC).
- May 7 Arrangement of equipment for survey.
- May 8 Meeting with M/I. & B. and SLBC (Confirmation of scope of survey work and schedule). Meeting with the Japanese Embassy.'
- May 9 Inspection of main service areas.
Inspection of SLBC radio house and proposed TV studio.
- May 10 Meeting with SLBC.
Discussion of desk plan.
- May 11 Radio propagation test between Mt. Pidurutalagala and Colombo. Meeting with the Senior Assistant Secretary of M/I. & B. and the Director General of SLBC.
- May 12 Meeting with the Japanese Embassy.
- May 13 Preparation for radio propagation test.
- May 14 Same as above.
- May 15 Moves from Colombo to Nuwara Eliya.
Divides the survey team into 5 groups. Transmission at proposed transmitting site, field strength measurement at

proposed transmitting site, field strength measurement in service areas and meeting with M/I. & B., SLBC and Japanese Embacy.

May 16 Map survey.
Sets up tents at Mt. Pidurutalagala.
Meeting with SLBC.

May 17 Transportation of transmitting equipment to Mt. Pidurutalagala and setting of equipment thereat.

May 18 Starts radio propagation test.
Field strength measurement in Pottuvil, Amparai, Gall, Weligana, and Belliatta areas.
Meeting with M/I. & B. and Japanese Embassy regarding access road to Mt. Pidurutalagala.

May 19 Field strength measurement in Batticaloa, Punani, Polonaruwa, Kantalai, Trincomalee, and Hambantota areas.

May 20 Field strength measurement in Trincomalee, Sigiria, Pambulla, and Minneriya areas.

May 21 Field strength measurement in Nuwara Eliya and Kandy areas and site survey in Kandy and Polonaruwa areas.

May 22 Field strength measurement in Kurunegala, Colombo, Minneriya, Ganewalpola, Yakalla and Anuradhapura areas.
site survey at Anuradhapura,

May 23 Field strength measurement in Puttalam, Medawachchiya, Vavuniya, Puliyankulam, Nedunkeni, Odduchuddam, and Mankulam areas.

May 24 Dismantles transmitting equipment from Mt. Pidurutalagala.
Inspection of the radio transmitting station.

May 25 Analysis of data obtained by measurement.
Site survey at Kandy.

May 26 Radio propagation test between Kokavil and Madukanda.
Meeting with SLBC and Japanese Embassy Intermediate review of survey results.

May 27 Sets up transmitting equipment at Kakavil.
Inspection of Madukanda Microwave Repeater Station.
Field strength measurement in Mankulam and Pullankulam areas.

May 28 Field strength measurement in Elephant-Pass, Paranthan, Mullative, Oddusuddan, and Tunukkai areas.

May 29 Field strength measurement in Pallai Beach, Jaffna, Champiyanpath areas.
Dismantles transmitting equipment at Kokavil.

May 30 Moves from Kokavil to Trincomalee Data analysis.

May 31 Moves from Trinchnmalee to Kandy.
 Site survey in Kandy.

June 1 Radio propagation test in Kandy area.

June 2 Data analysis.

June 3 Meeting with M/I. & B.
 Arrangement of equipment for survey.

June 4 Meeting on survey results.
 Packing of equipment to be returned to Japan.

June 5 Meeting with the Minister of Information and Broadcasting
 and Japanese Ambassador.
 Salutation to the President of Sri Lanka and reporting of
 survey results to the President from the Japanese Ambassador.

June 6 Preparation of interim report (draft).
 Forwards equipment to be returned to Japan.

June 7 Preparation of interim report (draft).

June 8 Preparation of interim report (draft).
 Meeting with the Japanese Embassy for discussion on interim
 report (draft).

June 9 Submits the interim report to the Minister of Information and
 Broadcasting. Reports survey results to the Japanese
 Ambassador.

June 10 Preparation for returning to Japan.

June 11 Leave Colombo at 14:05 (SQ582) and arrives in Singapore at 19:50.

June 12 Leave Singapore at 07:45 (JAL 716) and arrives in Tokyo at
 18:20.

SECTION 2 CONCLUSION AND RECOMMENDATIONS

2-1 Plan for Introduction of Television Broadcasting

In order to progress the overall nationwide development project of constructing the television broadcasting network, the Government of the Republic of Sri Lanka is required to procure high-level human resources as well as to achieve the understanding and cooperation of the people for the national project.

It is extremely effective for the actual enforcement of measures and policies of a country to introduce a nationwide television broadcasting network and allow education of the people in acquiring necessary knowledge and techniques for various development plans and presentation of official reports and information to the people.

Broadcasting cultural programmes as well as educational ones will facilitate correction of what should be corrected between different areas or districts and uniform distribution of education and culture so as to allow mutual understanding among people, which will greatly contribute to the social and economical development of Sri Lanka.

2-2 Scale of Broadcasting Network

In order to construct the nationwide television broadcasting network, it is suitable to locate a studio in Capital Colombo and transmitting stations at Mt. Pidurutalagala, Kokavil, and Kandy.

By thus locating the studio and transmitting stations, television broadcasting service will be presented to about 87% of the whole population of the country.

Signal transmission for relaying broadcast programmes can be achieved by using a self-managed microwave links, rebroadcasting links and P & T's microwave links in combination.

2-3 Channel Plan

It is recommended to employ Band III for the television broadcasting frequency band.

Channel plan should be prepared in consideration of the effective use of frequencies, propagation characteristics, future expansion in broadcasting network, etc.

2-4 Standard Systems of Television Broadcasting

It is recommended to adopt System B in the CCIR Recommendation and the PAL system for the standard systems of television broadcasting, in consideration of the requirements of the Government of Sri Lanka and the situation of the neighbouring countries operating television broadcasting.

2-5 Facility Plan

- (1) It is suitable to construct the studio at the site located just in front of the Sri Lanka Broadcasting Corporation. The studio building should be designed to be so large that will allow television programmes to be broadcast for 5 ~ 6 hours a day and with due consideration for future expansion.

Two studio rooms, one as wide as 200m² and the other 100m² will be provided. It is recommended to initially furnish these studio rooms with such equipment and facilities that will allow broadcasting for 2 ~ 3 hours a day and then gradually increase or upgrade equipment and facilities step by step in future. Equipment necessary for preparing outdoor programmes and news gathering should also be provided at the studio.

- (2) Mt. Pidurutalagala Transmitting Station should cover as much wide service area as practicable and should thus provide a transmitter output power of 20 kW.

For the transmission of programmes from the studio a 7GHz-band receiver will be installed at the transmitting station.

Access road should be constructed at an early time so as to allow transportation by automobiles of construction materials and radio equipment and facilities to be installed upon constructing the transmitting station and for maintaining the transmitting station after completion of its construction.

- (3) Kokavil Transmitting Station will be located on a flat area, so that it is recommended that the height of its transmitting antenna should be made about 100m and its transmitter output power 20kW.

For the transmission of broadcast programmes it is suitable to substitute rebroadcasting links for part of the sections covered by the Indo-Sri Lanka Microwave System (between Mt. Pidurutalagala Transmitting Station and Madukanda P & T Terminal Station) until the Indo-Sri Lanka Microwave System being constructed by P & T will be completed. For this purpose, a receiver for rebroadcasting links will be installed at Madukanda Repeater Station. After completion of the microwave system, this receiver will be used as a spare for developing the system reliability.

- (4) Kandy Transmitting Station should desirably be located on Primrose Hill in the southeast of the urban district so as to secure as wide a service area against the topographical condition of Kandy City and its neighbouring areas which involves many ups and downs.

The transmitter output power will be 50W. The programme from Mt. Pidurutalagala Transmitting Station will be rebroadcast at this station.

(5) Kandy Transmitting Station and Madukanda Repeater Station will be constructed next to the existing P & T facilities. Of the existing facilities, the steel towers, station buildings, and main power sources may be usable in common, so that thorough discussion should be made with P & T in consideration of the convenience of maintenance, operation, and adjustment for achieving cost reduction in the project.

2-6 Implementation Plan

Implementation of the construction of the nationwide television broadcasting network will require a period of about 21 months. It is important to assign excellent broadcasting facility consultant and architectural consultant and advance the construction in a well-programmed manner through close contact with both consultants.

A total of about 3,500 million yen (276 million rupees) will be necessary for the construction of the nationwide television broadcasting network (excluding construction budget for works incidental to access road, ground leveling, power lines, etc.). The expense for the operation and maintenance (excluding personnel expense) after inauguration of the broadcasting service will be about 12 million rupees in the first year.

2-7 Operation Plan

Television broadcasting is to be introduced as a measure or policy to be enforced by the Government of Sri Lanka. It is recommended that television broadcasting should be operated by a public corporation or the Government in consideration of the purposes and operating expenses of the broadcasting service.

It is suitable to expand and strengthen the Sri Lanka Broadcasting Corporation engaged in the radio broadcasting service so as to be able to operate the television broadcasting service as well.

2-8 Popularization Plan of TV Receivers

It is very important, from the standpoint of introducing television broadcasting, for television receivers to spread among people. However, in consideration of the present economic situation of Sri Lanka, rapid spread of TV receivers is rather difficult. In these circumstances, it is desirable to progress the spread of TV receivers step by step by taking the following measures.

- (1) Installation of TV receivers at public institutions
- (2) Installation of TV receivers at busiest quarters
- (3) Introduction of audience participation programmes
- (4) Lowering of receiver prices
- (5) Establishment of receiver servicing (aftercare) system

2-9 Personnel and Training Plans

Planning and operation of the nationwide television broadcasting will require a number of talented personnel in the fields of broadcasting technology, programme production, management and administration, etc.

In order to procure such high-level personnel, it is necessary to make a detailed long-term personnel plan. It may be desirable, for the time being, to select competent personnel from among the personnel of the Sri Lanka Broadcasting Corporation and provide them with necessary training so that they can handle the nationwide television broadcasting. Two different types of training will be provided for the personnel: training to be conducted abroad by sending leading personnel in respective fields to appropriate foreign countries for acquiring various broadcasting techniques and knowledge and on-the-job training to be conducted at job sites by the leading personnel having completed the training abroad.

These two types of training should be planned and conducted systematically.

2-10 Programme Plan

In order to raise the effect of the introduction of television broadcasting, it is extremely important to properly form broadcast programmes. In planning programme schedules, qualitative development should be stressed much more than quantitative expansion.

To be concrete, an effective programme planning should be achieved by introducing mainly adult education programmes related to agriculture, fishery and various other industries for promoting the development of the country, news programmes, official report and information, and entertainment programmes. Broadcasting hours will initially be 2 ~ 3 hours a day and should gradually be increased with the progress in the provision of personnel and the development in their technical capabilities.

2-11 Economic Evaluation

Introduction of the nationwide television broadcast network in Sri Lanka will bring about development in education and culture of people which is the foundation for the development of the country, will allow supply of excellent human resources inevitable for the development of the country and will greatly contribute to the social and economical development of the country and thus can be assessed to be sufficiently feasible from the economic standpoint.

PART II DETAILED DESCRIPTION

SECTION 1 TELEVISION BROADCAST NETWORK INTRODUCTION PLAN

1-1 Broadcasting Network Plan

The site location of each transmitting station, transmitting condition, channel plan, etc., have been determined on the premise to construct a nationwide broadcasting network for achieving national unity in education, politics, economics, culture and other activities of the people.

1-1-1 Site Selection of Transmitting Stations

The site selection of transmitting stations has been made to meet the following principles and requirements for ensuring effective reception of broadcast programmes in areas to be covered by the broadcasting service and effective operation and management of the broadcasting service.

- (1) To assure efficiency and economy by selecting the top of mountains or hills with considerable altitudes
- (2) To eliminate the cause of ghost on the receivers' side due to topographical conditions or buildings
- (3) To provide satisfactory propagation characteristics in most areas to be covered
- (4) To allow transmitting station building and aerial towers to be constructed
- (5) To allow such incidental work as the construction of water supply and drainage, power line, and access roads to be accomplished
- (6) To provide satisfactory environmental condition for broadcasting facilities
- (7) To allow smooth operation and maintenance after service in as the result

As the result of examination thus made on the abovementioned principles, three transmitting station sites, i.e., Mt. Pidurutalagala, Kokavil, and Kandy, have been selected to allow effective coverage over nearly the entire country by such a few transmitting stations.

See Figs. 1-1 through 1-3.

1-1-2 Transmitting Condition

The transmitting condition (transmitter output power, type of aerial, directivity pattern, etc.) should be such that the required field strength of $55\text{dB}/\mu\text{V}$ ^[Note 1] will be available at a height of 10 meters above the ground in the intended service area.

Table 1 Transmitting Condition

	Transmitting Stations		
	Mt. Pidurutalagala	Kokavil	Kandy
Transmitter Output	20kW (10kW x 2 Parallel Ope.)	20kW (10kW x 2 Parallel Ope.)	50W (Stand-by Ope.)
Transmitting Aerial	4 dipole/4 stacks 4 faces Total 16 panels	4 dipole/4 stacks 4 faces Total 16 panels	2 dipole 4 faces Total 4 panels
Tower Height (above ground level)	50 m Self-supporting	100 m Supported by guy wires	30 m Self-supporting
Service Pattern	Omnidirectional	Omnidirectional	Omnidirectional
Polarization	Horizontal	Horizontal	Horizontal
E.R.P.	Approx. 210 kW	Approx. 195 kW	Approx. 60 W

- (1) The effective radiation power (ERP) of Mt. Pidurutalagala is expected to be sufficient for providing required field strength for rebroadcasting to Kokavil and Kandy Transmitting Stations.
- (2) The ERP of Kandy Transmitting Station is so selected as to reduce picture quality degradation due to ghost.
- (3) Consideration is taken for fringe areas where reception is poor due to null points. [Note 2]

Note 1: CCIR Recommendation 417-2 sets out 55dB/μV as the goal of minimum field strength for protection against interference from other stations. The areas covered by field strengths exceeding this value is designated as the service area.

Field strengths and Picture Quality

(from NHK's data)

Picture Quality	Evaluation of Picture Obtained	C/N
5 (Excellent)	No disturbance is observed	More than 48 dB
4 (Good)	Disturbance is present but unnoticed	More than 37 dB
3 (Fair)	Disturbance is noticed but not troublesome	More than 29 dB
2 (Poor)	Disturbance is obvious and troublesome	More than 22 dB
1 (Unusable)	Reception is not achievable due to excessive disturbance	Less than 22 dB

If a receiving field strength of 55 dB/μV is obtained by using a Yagi aerial (of 8 elements) at 10 meters above the ground level in the neighborhood of a fringe area, the receiver input voltage becomes 63.8 dB by the following equation.

$$V_{in} = E \cdot \frac{\lambda}{\pi} \sqrt{\frac{G_a}{L_f}} \cdot \sqrt{\frac{R_{in}}{73.13}}$$

Where E: receiving field strength (=55dB/μV)

λ: wavelength (=1.6 meters)

G_a: aerial gain (=10 dB)

L_f: feeder loss (=1.5 dB)

R_{in}: input impedance (=300 Ω)

The relation between the receiver input voltage and C/N can be obtained by

$$C/N = \frac{V_{in}^2/R_{in}}{4NF \cdot KTB}$$

Where V_{in}: receiver input voltage (=63.8 dB)

R_{in}: input impedance (=300 Ω)

NF: noise figure (=8 dB)

K: Boltzmann's constant (1.37 x 10⁻²³)

T: absolute temperature (273° + t° = 298°)

B: equivalent noise bandwidth (=4 x 10⁶ Hz)

When the receiver input voltage is 63.8 dB, the C/N is 42.6 dB. Accordingly, when the required field strength is set at 55dB/μV, a picture quality exceeding "4" (good) can be achieved.

Note 2: Because of the characteristic of the transmitting aerial, locations where the field strength is extremely small may appear at specific azimuth angles, as shown below. These locations are called null points.

In order to eliminate receiving obstacles at the null points, null filling-in will be adopted for improving the field strength characteristics at Mt. Pidurutalagala and Kokavil Transmitting Stations.

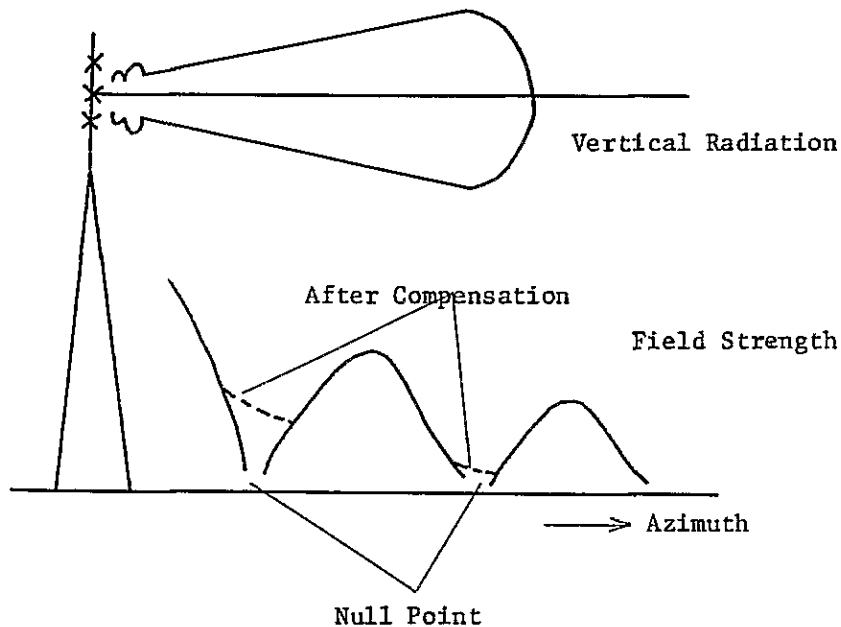

1-1-3 Service Area

The service area is such an area that provides field strengths exceeding 55dB/ μ V to a receiving aerial erected 10 meters above the ground level.

In determining the service area propagation tests were conducted in most areas for confirming the picture qualities to be obtained. For some areas the service area has been determined by calculation as per the VHF propagation curves. [Note 3]

As the result it has been confirmed that almost the entire land of Sri Lanka including her major cities will be covered in the service area by locating transmitting stations at Mt. Pidurutalagal, Kokavil, and Kandy. See Fig. 2-1. To be concrete, about 84% of the whole land of Sri Lanka or about 87% of the total population of the country will be covered.

It is also to be noted that outside the service area good picture qualities will be obtainable by erecting high receiving aerials or employing

high-gain aerials.

Dead zones may be produced because of topographic conditions, which can be eliminated or improved by common reception or by the introduction of translator stations.

Note 3:

- (1) A propagation curve was prepared for the calculation of Ref. DWG. 1 on the basis of VHF and UHF propagation curves in the 30 ~ 100MHz frequency band set out in CCIR Recommendation 370-2 (1974, Geneva) in consideration of the results of the propagation test performed in the present survey and the refractive index specified in CCIR Report 233-2.
- (2) For diffraction loss by knife edges, see Ref. DWG. 2.

1-1-4 Channel Plan

The channel plan has been prepared on the following principles in consideration of the frequency utilization condition in Sri Lanka, effective use of channels, convenience for viewers, propagation characteristics, and future expansion of broadcasting network.

- (1) To select necessary channels in a frequency band on the principle of frequency allocation.
- (2) To select channels in Band III where interference due to abnormal propagation (by sporadic E layer, etc.) will be reducible.
- (3) Consideration be taken for allowing plural channels to be assigned to an area for future expansion of the broadcasting network.
- (4) Not to assign adjacent channels to an area in consideration of receiver selectivity.
- (5) To assign a high channel to Kandy Transmitting Station for reduction of ghost due to the topographical condition (ravine).
- (6) The interference protection ratio be 40dB for identical channels and 0dB for adjacent channels, as standard.

Table 2 Channel Plan

Channel No. (Note 4)	Transmitting Station		
	Mt. Pidurutalagala	Kokavil	Kandy
5	⊙		
6		○	○
7	○		
8		⊙	○
9	○		
10		○	⊙

Legend

⊙ : Assigned channel

○ : Channel to be adopted upon future network expansion

Note 4: Possible channel allocation in Band III.

Channel No.	Frequency Range (MHz)	Vision Frequency (MHz)	Sound Frequency (MHz)
5	174 ~ 181	175.25	180.75
6	181 ~ 188	182.25	187.75
7	188 ~ 195	189.25	194.75
8	195 ~ 202	196.25	201.75
9	202 ~ 209	203.25	208.75
10	209 ~ 216	210.25	215.75

1-1-5 Standards

(1) Television standards

CCIR System B

(2) Color System

PAL System

(3) Main characteristics of CCIR recommended System B

Item	Characteristics	B System Television
1	Number of line per picture/frame	625
2	Field frequency, nominal value (field/second)	50
3	Line frequency f_H and tolerance when operated nonsynchronously (Hz)	$15,625 \pm 0.02\%$
4	Nominal bandwidth (MHz)	5
5	Nominal radio-frequency channel bandwidth (MHz)	5.5 ± 0.0017
6	Sound carrier relative to vision carrier (MHz)	5.5 ± 0.001
7	Nearest edge of channel relative to vision carrier (MHz)	-1.25
8	Nominal width of main sideband (MHz)	5
9	Nominal width of vestigial sideband (MHz)	0.75
10	Type of polarity of vision modulation	A5C neg.
11	Type of sound modulation	F3
12	Frequency deviation (kHz)	± 50
13	Pre-emphasis for modulation (μ s)	50

(Continued)

Item	Characteristics	B System Television
14	Ratio of effective radiated power of vision and sound	10/1
15	Synchronization of power supply frequency	Non

(4) Main characteristics of the video signal for PAL B Colour television System

Item	Characteristics	PAL B Colour Television																			
1	Assumed chromaticity coordinates for primary colour of receiver	<table border="1"> <thead> <tr> <th>Re</th> <th>X</th> <th>Y</th> </tr> </thead> <tbody> <tr> <td>Red</td> <td>0.64</td> <td>0.33</td> </tr> <tr> <td>Green</td> <td>0.29</td> <td>0.60</td> </tr> <tr> <td>Blue</td> <td>0.15</td> <td>0.06</td> </tr> </tbody> </table>	Re	X	Y	Red	0.64	0.33	Green	0.29	0.60	Blue	0.15	0.06							
Re	X	Y																			
Red	0.64	0.33																			
Green	0.29	0.60																			
Blue	0.15	0.06																			
2	Luminance signal	$E'Y = 0.299E'R + 0.587E'G + 0.114E'B$ $E'R, E'G$ and $E'B$ are gamma-precorrected primary signals																			
3	Chrominance signals (Colour difference)	$E'u = 0.493 (E'B - E'Y)$ $E'v = 0.877 (E'R - E'Y)$																			
4	Attenuation of colour difference signals	<table border="1"> <thead> <tr> <th></th> <th>dB</th> <th>MHz</th> </tr> </thead> <tbody> <tr> <td>$E'u$</td> <td>3</td> <td>at 1.3</td> </tr> <tr> <td>$E'v$</td> <td>20</td> <td>at 4</td> </tr> </tbody> </table>		dB	MHz	$E'u$	3	at 1.3	$E'v$	20	at 4										
	dB	MHz																			
$E'u$	3	at 1.3																			
$E'v$	20	at 4																			
5	Equation of composite colour signal	$E_M = E'Y + E'u \sin 2\pi f_{sc} t \pm E'v \cos 2\pi f_{sc} t$ <p>where $E'Y$, see item 2 $E'u$ and $E'v$, see item 3 f_{sc}, see item 7 The sign of the $E'v$ component is the same as that of the subcarrier burst (changing for each line) (See item 8)</p>																			
6	Type of chrominance modulation subcarrier	Suppressed-carrier amplitude-modulation of two subcarrier																			
7	Chrominance subcarrier frequency nominal value and tolerance (Hz)	$4,433,618.75 \pm 1$																			
8	Phase of chrominance subcarrier burst	135 relative to $E'u$ axis with the following sign <table border="1"> <thead> <tr> <th rowspan="2">Line</th> <th colspan="4">Field</th> </tr> <tr> <th>1</th> <th>2</th> <th>3</th> <th>4</th> </tr> </thead> <tbody> <tr> <td>Odd line</td> <td>+</td> <td>+</td> <td>-</td> <td>-</td> </tr> <tr> <td>Even line</td> <td>-</td> <td>-</td> <td>+</td> <td>+</td> </tr> </tbody> </table>	Line	Field				1	2	3	4	Odd line	+	+	-	-	Even line	-	-	+	+
Line	Field																				
	1	2	3	4																	
Odd line	+	+	-	-																	
Even line	-	-	+	+																	

(5) Ideal frequency characteristic of CCIR B System

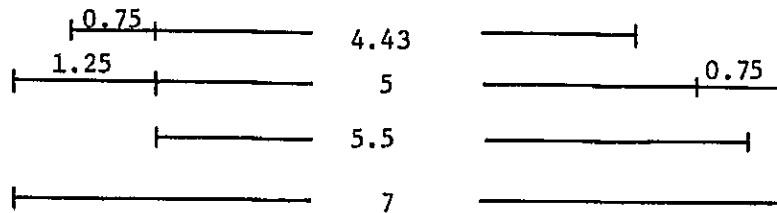
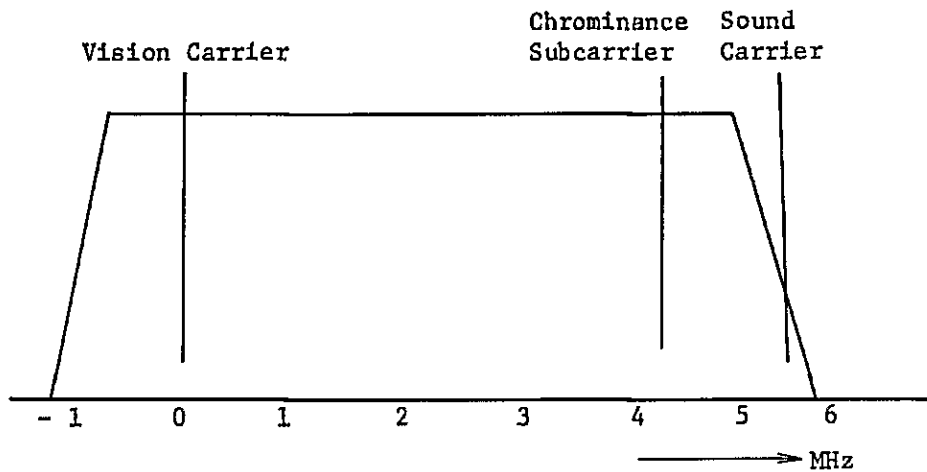

1-2 Broadcast Programme Transmission Plan

Broadcast programmes formed at the studio will be transmitted to each transmitting station on links.

1-2-1 Transmission on Links

Typical means for the transmission of such wideband signals as television signal are microwave system, coaxial cable system, and rebroadcasting link. The transmission system to be selected should be determined in consideration of ease of construction, operation and maintenance and economy. The major features of the respective transmission systems are as follows.

1. Microwave System

- (1) A microwave link can be formed almost irrespective of the distance of the section over which transmission is to be made. That is, economical efficiency is ensured when this transmission system is employed over long distance.
- (2) Necessity of system addition due to broadcasting network expansion will readily be coped. Unlike coaxial cable system, microwave system is free from excavation of roads, cable laying and other civil work upon system addition.

- (3) Formation of microwave system in urban areas may provide the problem of causing troubles due to high buildings, etc. (provision of clearance and interference ascribable to reflection).
- (4) Microwave system requires skillfulness with more equipment in maintenance and operation than in coaxial cable system and thus requires more time to master the usage of the equipment.
- (5) Microwave system is subject to interruption even if the propagation characteristics set out in the CCIR recommendation are met.
However, unlike coaxial cable system, microwave system requires no long time for recovery but can be restbred in very short periods of time.

2. Coaxial Cable System

- (1) Less crosstalk is involved in high frequency bands
- (2) Small transmission loss
- (3) Easy maintenance and operation
- (4) Excellent economic efficiency is ensured especially when the distance of the section is small.

3. Rebroadcasting Links

When the formation of a microwave or coaxial cable system is unsuitable or difficult due to the topographical condition or economical efficiency, the introduction of this method of transmission where TV programmes received from an upper-ranking station are rebroadcast is effective. It is to be noted, however, the input signal level to the receiver for rebroadcasting should be more than 50dBt and a proper measure should be taken not to cause picture quality degradation due to field variation of the receiving broadcasting signal.

1-2-2 Link Network

It is recommended that links for Mt. pidurutalagala, Kokavil and Kandy Transmitting Stations should be as follows in consideration of topographical conditions, technical conditions, and economical efficiency, as well as the result of comparison made by the features specified in paragraph 1-2-1.

(1) Mt. Pidurutalagala Transmitting Station

A self-managed microwave link of 7GHz band will be employed for transmission from Colombo studio.

(2) Kokavil Transmitting Station

- 1) For the Colombo studio - Colombo P & T terminal station section, a 7GHz band self-managed microwave link will be adopted.

- 2) For the Colombo P & T terminal station - Madukanda P & T terminal station section, a P & T's Indo-Sri Lanka Microwave System using the 7GHz band will be used.
- 3) For Madukanda P & T terminal station - Kakavil transmitting station section, a 7GHz-band self-managed microwave link will be employed.

Note: Since the construction schedule of the Indo-Sri Lanka Microwave System is not jointed with this project, programme transmission in some sections (such as between Mt. Pidurutalagala Transmitting Station and Mudukanda P & T Terminal Station) will be tentatively performed by a rebroadcasting links until the Indo-Sri Lanka Microwave System is completed. After completion of the Indo-Sri Lanka Microwave System, the rebroadcasting link thus used tentatively will be employed as a spare. The following links will be constituted tentatively.

- a) A 7GHz-band self-managed microwave link for programme transmission between Colombo Studio and Mt. Pidurutalagala Transmitting Station.
- b) A rebroadcasting link will be adopted for programme transmission between Mt. Pidurutalagala Transmitting Station and Madukanda P & T Terminal Station
- c) A 7GHz-band self-managed microwave link will be adopted between Madukanda P & T Terminal Station and Kokavil Transmitting Station.

(3) Kandy Transmitting Station

- 1) A 7GHz-band self-managed microwave system will be employed for programme transmission between Colombo Studio and Mt. Pidurutalagala Transmitting Station.
- 2) A rebroadcasting link will be employed for programme transmission between Mt. Pidurutalagala Transmitting Station and Kandy Transmitting Station.

Details of the respective programme transmission links are shown in Fig. 5-1.

1-2-3 Control, Monitoring and Orderwire Systems

(1) Mt. Pidururalagala Transmitting Station (Unattended)

For control, monitoring and orderwire circuits between Mt. Pidurutalagala Transmitting Station and Colombo Studio, a 7GHz-band link and a 160 MHz-band link will be employed.

(2) Kokavil Transmitting Station (Attended)

Orderwire circuits will be formed between Colombo Studio and Kokavil Transmitting Station by P & T's wired circuits (for exclusive use).

(3) Kandy Transmitting Station (Unattended)

Monitoring and orderwire circuits will be formed between Colombo Studio and Kandy Transmitting Station by P & T's wired circuits (for exclusive use).

1-3 Programme Plan

The scale of broadcasting facilities and personnel to be employed are determined by the programme plan, which forms the gist of broadcasting station operation.

(1) The principles of programming will be as follows on the basis of the purposes of the television broadcast network construction project of Sri Lanka.

- 1) Presentation of a nationwide broadcasting service is intended.
- 2) Programming through utilization of the superiority of television broadcasting among various mass media.

Table 4-1 Specifications of Microwave Link (1)

Item	Symbol	Colombo→Pidurutalagala		Remarks
Frequency	f(MHz)	7,000		7GHz Band
Distance	d(km)	100		
Free Space Loss	Lf(dB)	149.3		
Transmitting Power	Pt(dBm)	40		10W
Transmitting Aerial Gain	Gt(dB)	45		4m∅ Parabolic Aerial
Receiving Aerial Gain	Gr(dB)	45		4m∅ Parabolic Aerial
Feeder Loss	LF(dB)	max.	12	
Receiving Power (=Pt-(Lf+LF)+(Gt+Gr))	Pr(dBm)	-31.3		Space diversity reception
Receiving Noise Power	Prn(dBm)	-87.2		Bandwidth: 30MHz Noise figure: 12dB
S/N Improvement Factor	I (dB)	13.5		
Signal-to-Noise Ratio (=Pr+I-Prn)	S/N(dB)	69.4		
Altitude of Station	(m)	5	2,518	
Aerial Height	(m)	40	25	

Table 4-2 Specifications of Microwave Link (2)

Item	Symbol	Madukanda→Kokavil		Remarks
Frequency	f(MHz)	7,000		7MHz Band
Distance	d(km)	58		
Free Space Loss	Lf(dB)	144.6		
Transmitting Power	Pt(dBm)	37		5W
Transmitting Aerial Gain	Gt(dB)	45		4m ϕ Parabolic Aerial
Receiving Aerial Gain	Gr(dB)	45		4m ϕ Parabolic Aerial
Feeder Loss	LF(dB)	max.	12	
Receiving Power (=Pt-(Lf+LF)+(Gt+Gr))	Pr(dBm)	-29.6		
Receiving Noise Power	Prn(dBm)	-87.2		Bandwidth: 30MHz Noise figure: 12dB
S/N Improvement Factor	I(dB)	13.5		
Signal-to-Noise Ratio (=Pr+I-Prn)	S/N(dB)	71.1		
Altitude of Station	(m)	190	64	
Aerial Height	(m)	60	70	

3) Adult education and presentation of official reports and information will be the major subjects of programmes. Adult education will be presented by programmes related to industrial guidance and education of human resources in agriculture, fishery, mining, etc., on the basis of the development plan of the country.

4) The broadcasting hours at the initial stage will be 2 ~ 3 hours per day.

(2) A weekly programme schedule, a weekly programme breakdown according to broadcasting means and a weekly programme classification table are given in Tables 5 ~ 7 for reference's sake.

1) Weekly programme breakdown according to broadcasting means will, in general, be determined in the following two different ways.

a) Broadcasting will be presented mainly by recorded programmes and "live" broadcast will be limited to some special programmes.

b) Live programmes and recorded programmes will be mixed alternately.

The example of programme schedules was prepared on the basis of b) above.

2) Classification of weakly programmes by type of programme will be based on the following principles in programming.

a) New reporting hours should be such that allows the people to be

informed of domestic and foreign news and information.

- b) Adult education should be such that will become a motive for expediting national development plans.
- c) Official reporting from the Government will be indispensable for progressing national development plans and for informing the people of Government's policies and measures.
- d) Entertainment and sport hours will be useful for providing healthy entertainment and recreation to the people and, at the same time, contributes to cultivation of artistic sentiments among people.

(3) In determining programme planning objections, it is desirable to establish such an organization that will publicize programming standards to allow smooth formation of appropriate programmes. In order to raise the effect of broadcasting, it will be desirable to make surveys on "how-the-people-spend-their-time," for providing major programmes in such hours suitable for the majority of people in watching television broadcasting service. The survey on "how-the-people-spend-their-time" is one of the major factors for determining future programming through expansion of broadcasting hours.

Table 5 Weekly Programme Schedule

Broadcast Time (H:M)	Hour/Min.	Broadcast Period of Time (Minute)	Monday	Tuesday	Wednesday	Thursday	Friday	Saturday	Sunday
0:00	18:55	5	Testpattern, Light music, National flag (Anthem), Station identification pattern (Call Sign) {Telecine} (5)						
	19:00	5	Adult education { No.2 Studio (Live)} (1)						
	19:05	10	News report (1)	News report (3)	{No.2 Studio (Live)} (1)				
	19:15	5	News report (2)		{VTR No.2 Studio } (1)				
	19:20	10	News report (4)		{No.2 Studio (Live)} (1)				
	19:30	30	Adult Education (2) {VTR-OR} (2)	Adult Education (3) {VTR-OR} (2)	Adult Education (5) {No.1 Studio (Live)} (2)	Adult Education (6) {VTR-OR} (2)	Adult Education (7) {VTR-No.1 Studio} (2)	Adult Education (9) {VTR-OR} (2)	Entertainment or Sports
1:05	20:00	30	Entertainment (1) {No.1 Studio (Live)} (4)	Adult education (4) {Telecine} (2)	Entertainment (2) {VTR-OR} (4)	Entertainment (3) {No.1 Studio (Live)} (4)	Adult Education (8) {VTR-OR} (2)	Entertainment {VTR-No.1 studio} (4)	{Telecine} (4)
	20:30	30	Official report from the Government						
			No.2 Studio (Live) (3) [(2)...1/4]						
2:05	21:00	2	Station identification pattern (Call sign), National flag (anthem) (5)						
2:07			Rebroadcast VTR (5)						

Remarks (1) No. 1 Studio: about 200 m² No. 2 Studio: about 100 m²
 (2) Words in () correspond to sound and figures in () represent types of programme.
 (3) Words in { } represent types of programme.

Table 6 Weekly Programme Breakdown by Broadcasting Means

Means of Reproduction	Major Recording System	Broadcasting Period (Min.)	Percentage (%)
Telecine	Opaque Slide Film	139	16
Live broadcasting	No.1 Studio	90	10
	No.2 Studio	355	40
VTR	Outside broadcasting	180	20
	No.1 Studio	60	7
	No.2 Studio	35	4
	VTR	30	3
Total		889	100

Table 7 Classification of Types of Programme

Type of Programme	Broadcasting Period (Min.)	Percentage (%)	Remarks
(1) News report	175	20	
(2) Adult education	320	36	
(3) Official report	135	15	
(4) Entertainment & Sport	180	20	
(5) Others	79	9	Including broadcast channel pattern and rebroadcast programmes
Total		889	100

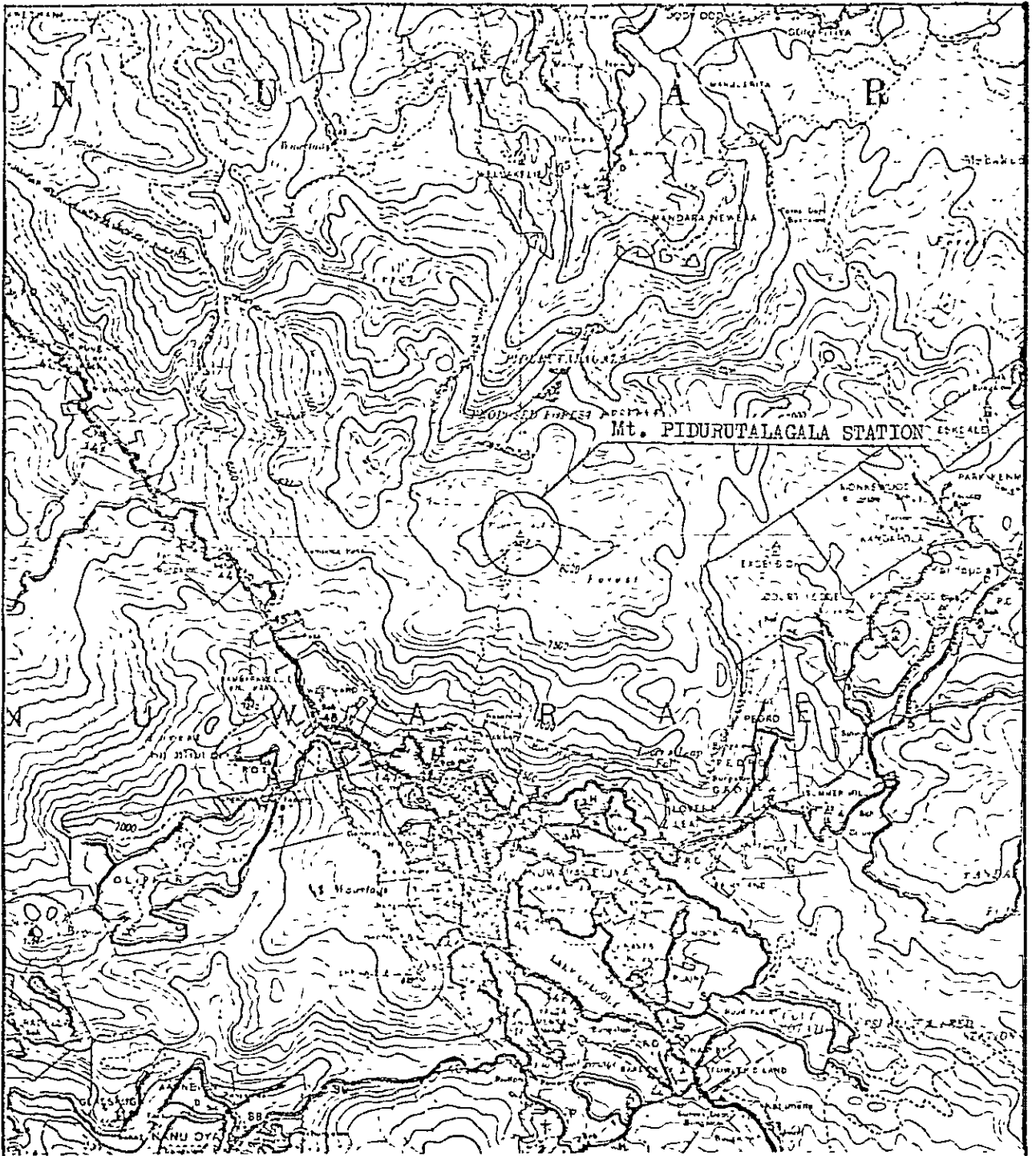

Scale 1 : 63, 360

Contour Interval 100 Feet

Proposed Site Position

Latitude : 7°00' 02" N

Longitude : 80°46' 18" E

Fig-1

**Location of Site for Mt.Piduru-
talagala Transmitting Station**

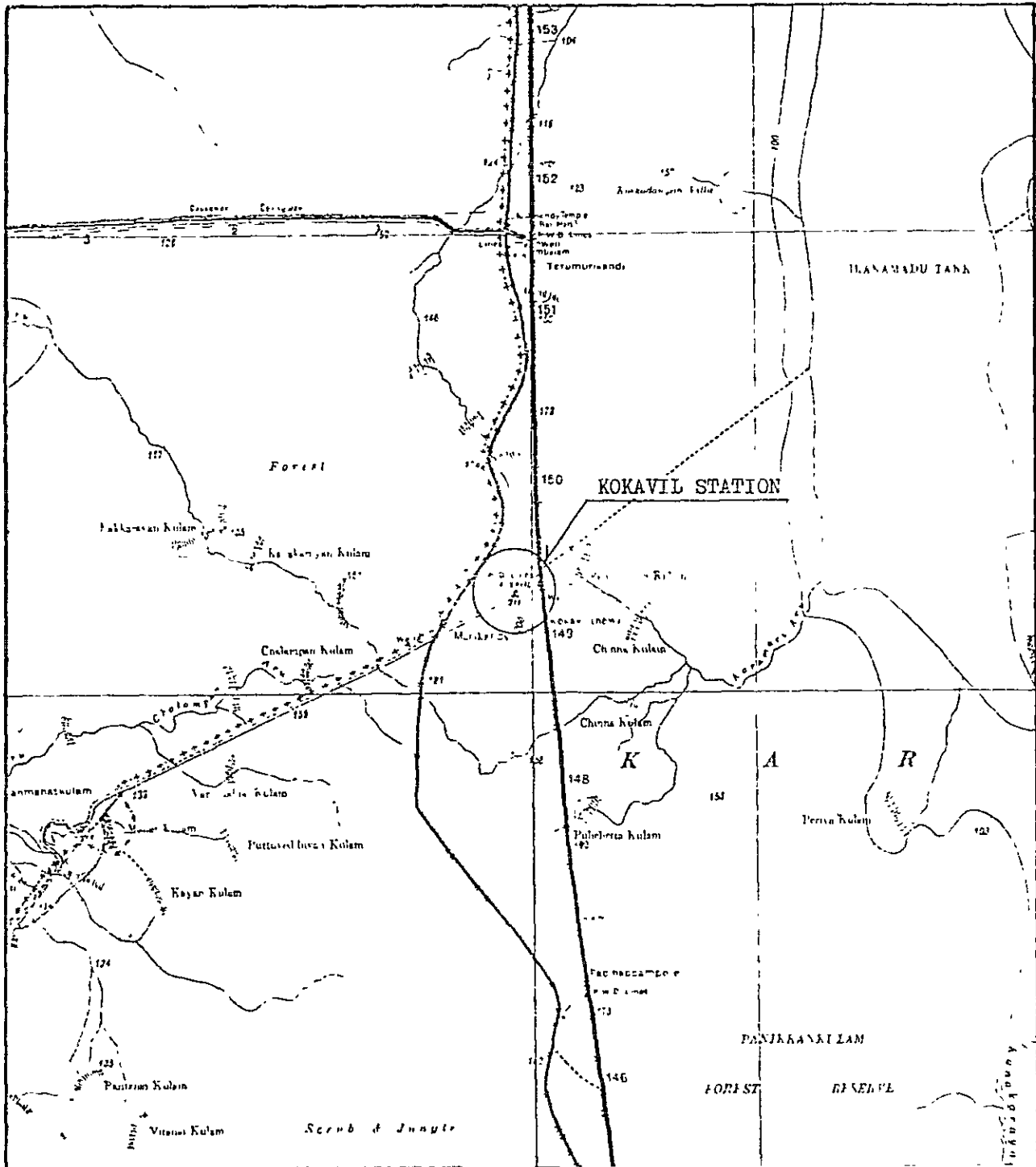

Proposed Site Position

Latitude : 9°16' 12" N

Longitude : 80°24' 18" E

Scale 1 : 63,360

Contour Interval 100 Feet

Figl-2
Location of Site for Kokavil
Transmitting Station

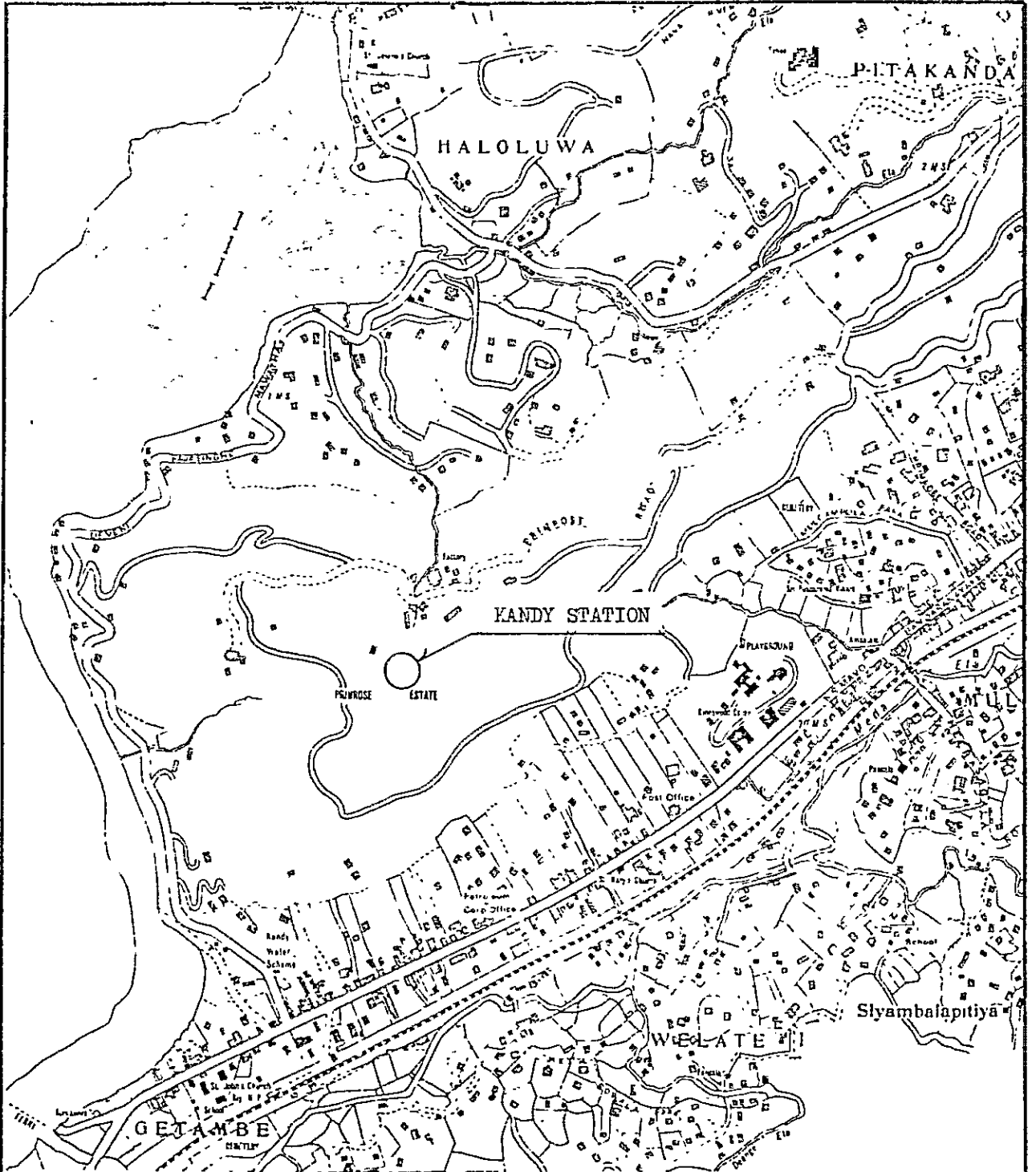

Contour Interval 100 feet

Scale 1 : 9, 504

Proposed Site Position

Latitude : 7° 16' 36" N

Longitude : 80° 36' 28" E

Fig1-3
Location of Site for Kandy
Transmitting Station



Scale 1 : 63,360

Proposed Site Position

Latitude : 6°54' 04" N

Longitude : 79°51' 53" E

Contour Interval 100 Feet

Fig-4
Location of Site for Colombo Studio

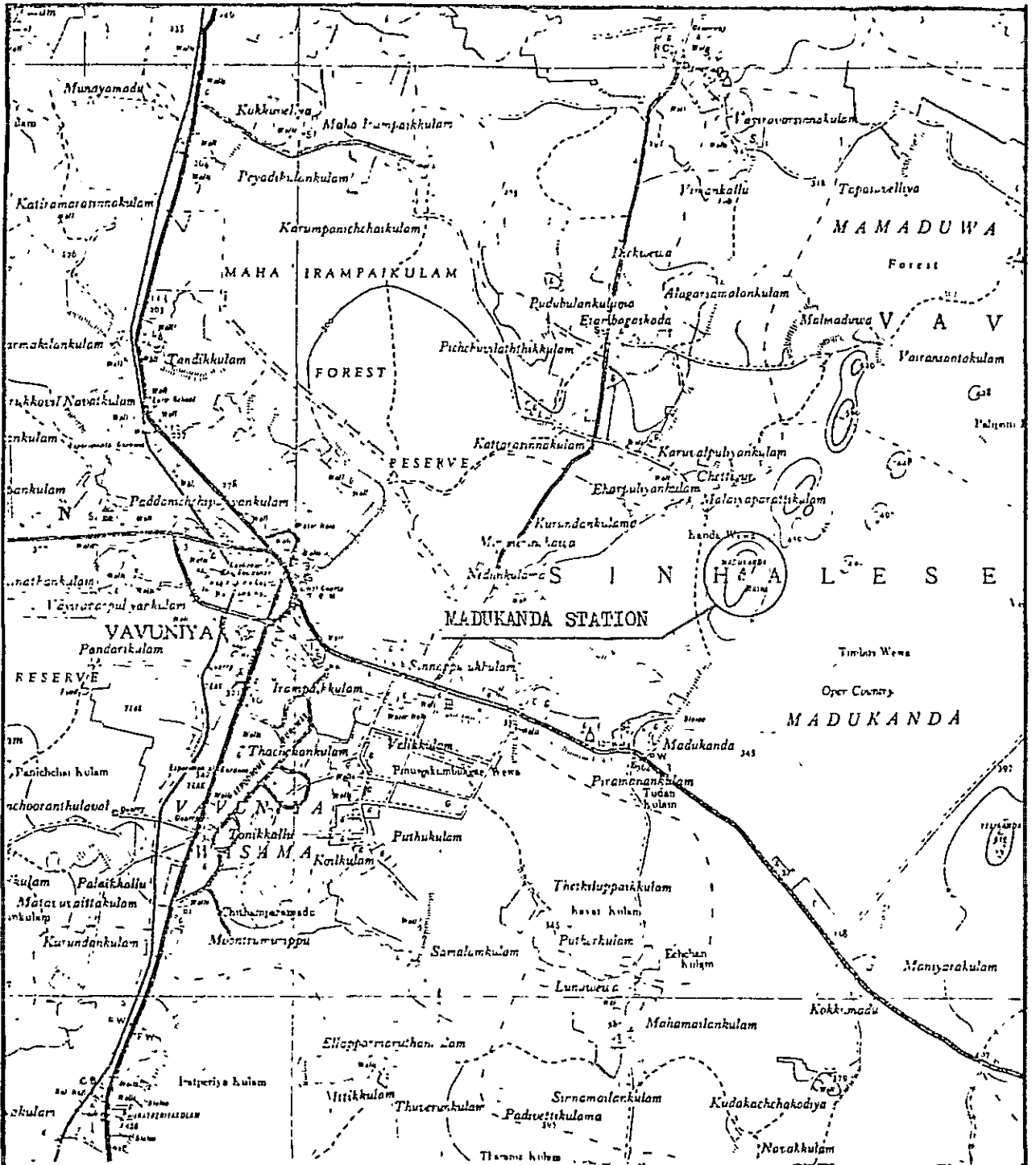

Proposed Site Position

Latitude : 8°45' 36" N

Longitude : 80°32' 40" E

Scale 1 : 63, 360

Contour Interval 100 Feet

Fig-5
Location of Site for Madukanda
Repeater Station



Fig. 2-1 MAP OF SERVICE AREA (1)

ELEVATION IN FEET
SCALE 1:1,000,000

.....

•

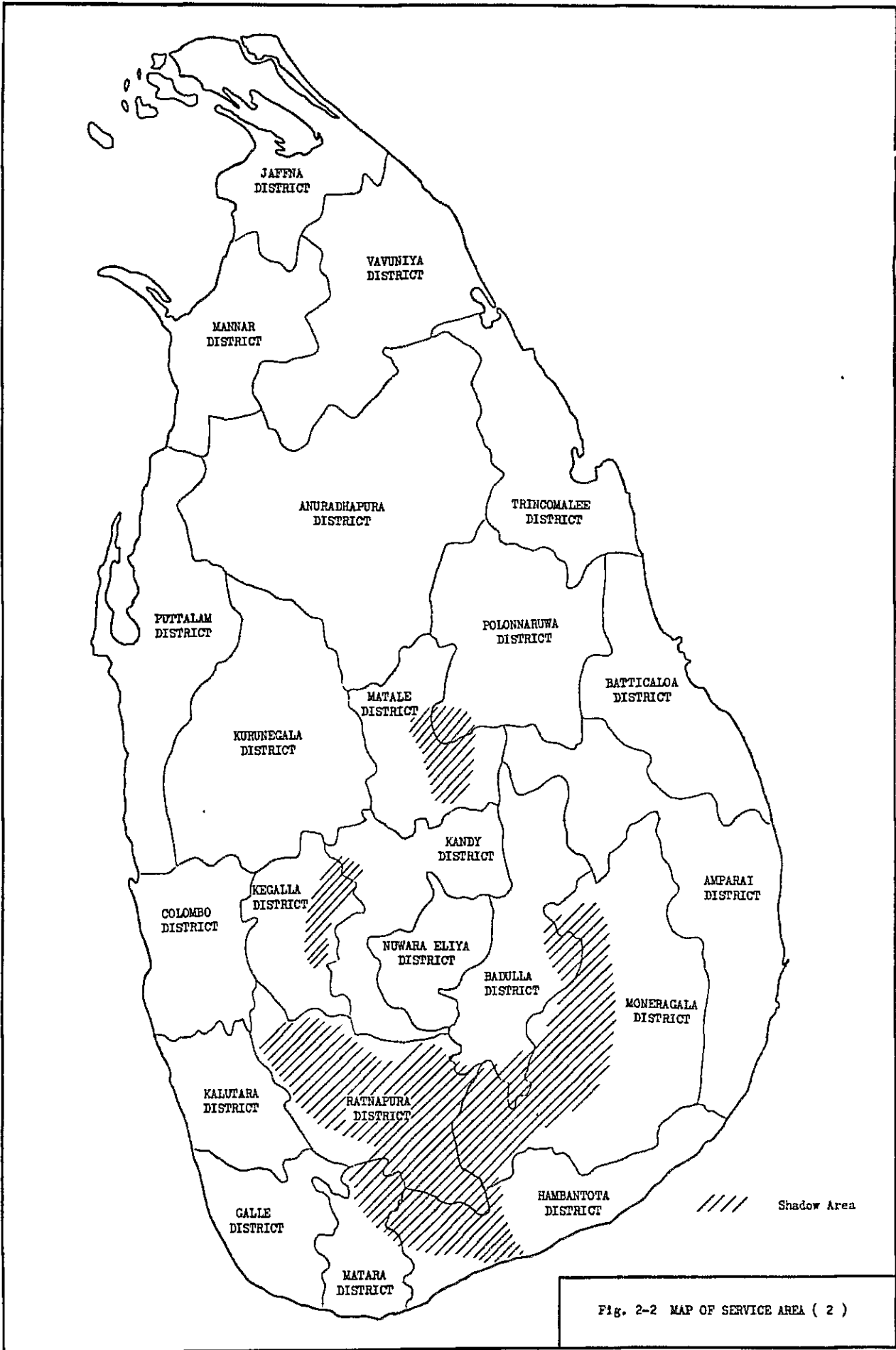
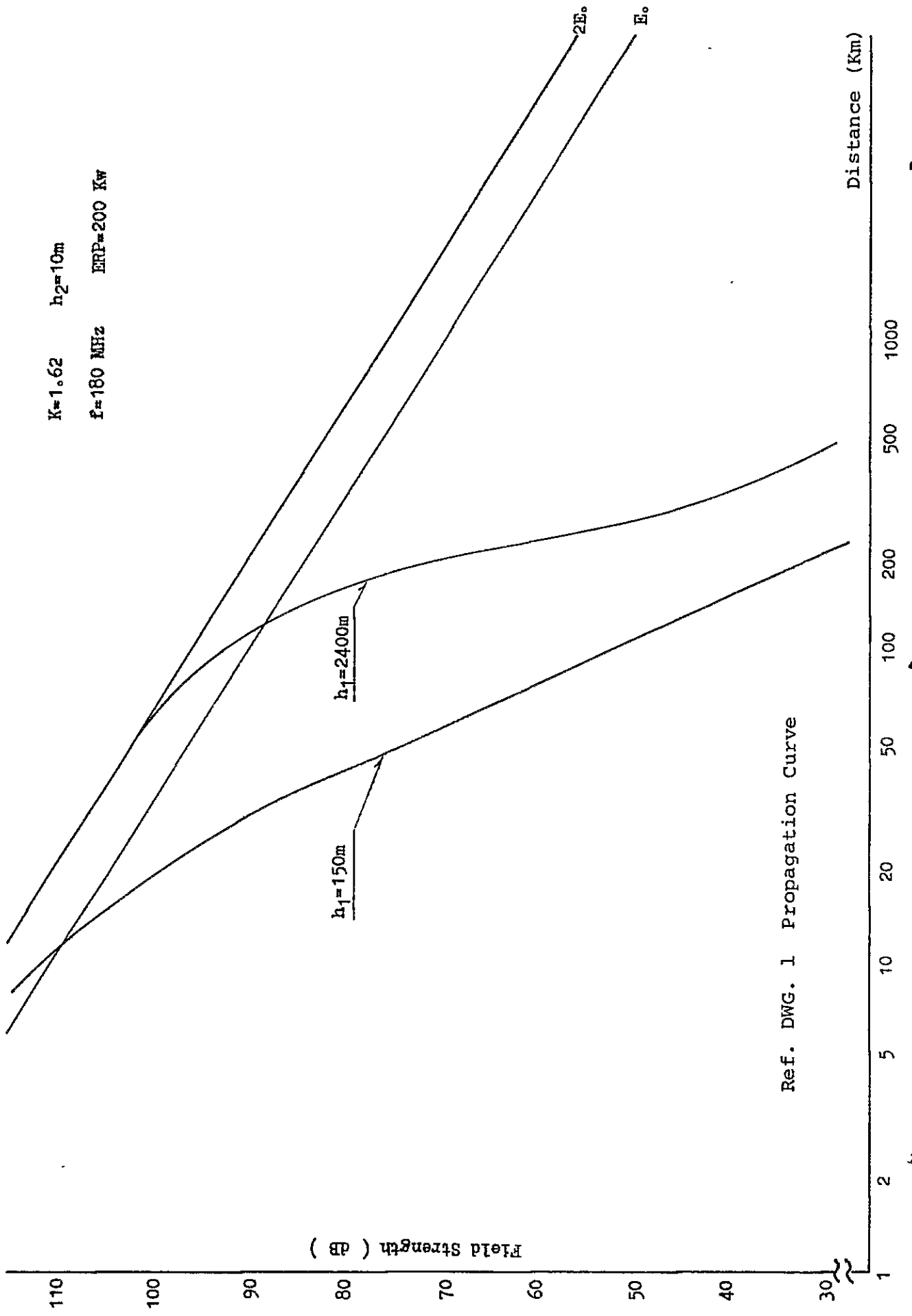

Fig. 2-2 MAP OF SERVICE AREA (2)

$K=1.62$ $h_2=10m$
 $f=180 \text{ MHz}$ $ERP=200 \text{ Kw}$



Ref. DWG. 1 Propagation Curve

Propagation loss caused by shielding of hills
(180 MHz)

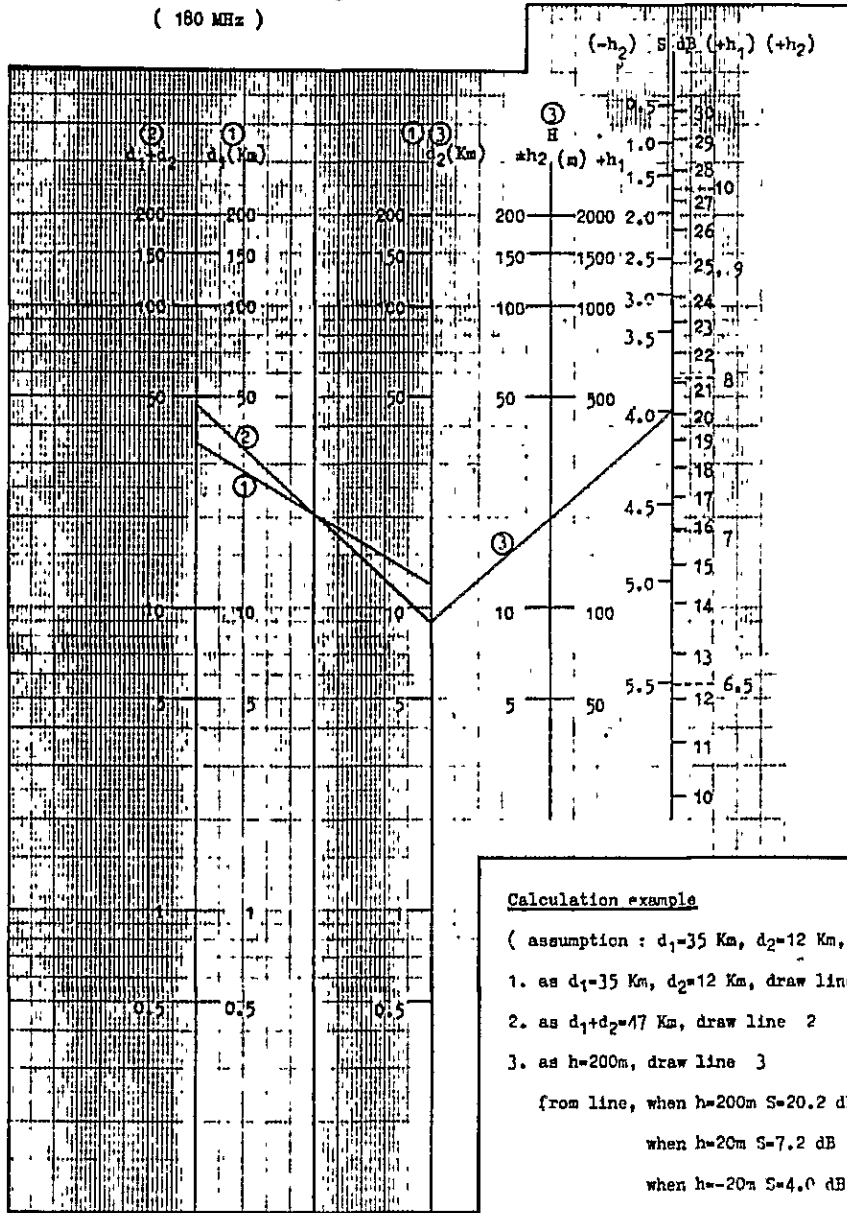

Calculation example

(assumption : $d_1=35$ Km, $d_2=12$ Km, h =parameter)

1. as $d_1=35$ Km, $d_2=12$ Km, draw line 1
2. as $d_1+d_2=47$ Km, draw line 2
3. as $h=200$ m, draw line 3

from line, when $h=200$ m $S=20.2$ dB

when $h=20$ m $S=7.2$ dB

when $h=-20$ m $S=4.0$ dB

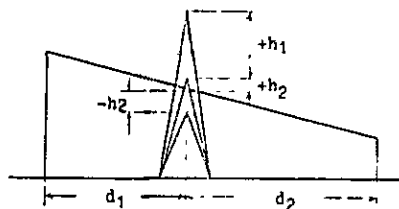

Ref. DWG. 2 Diffraction Loss by Knife Edges (180 MHz)

Fig 3 - 1

Horizontal pattern (ideal) for
Mt. PIDURUTALAGALA Transmitting station

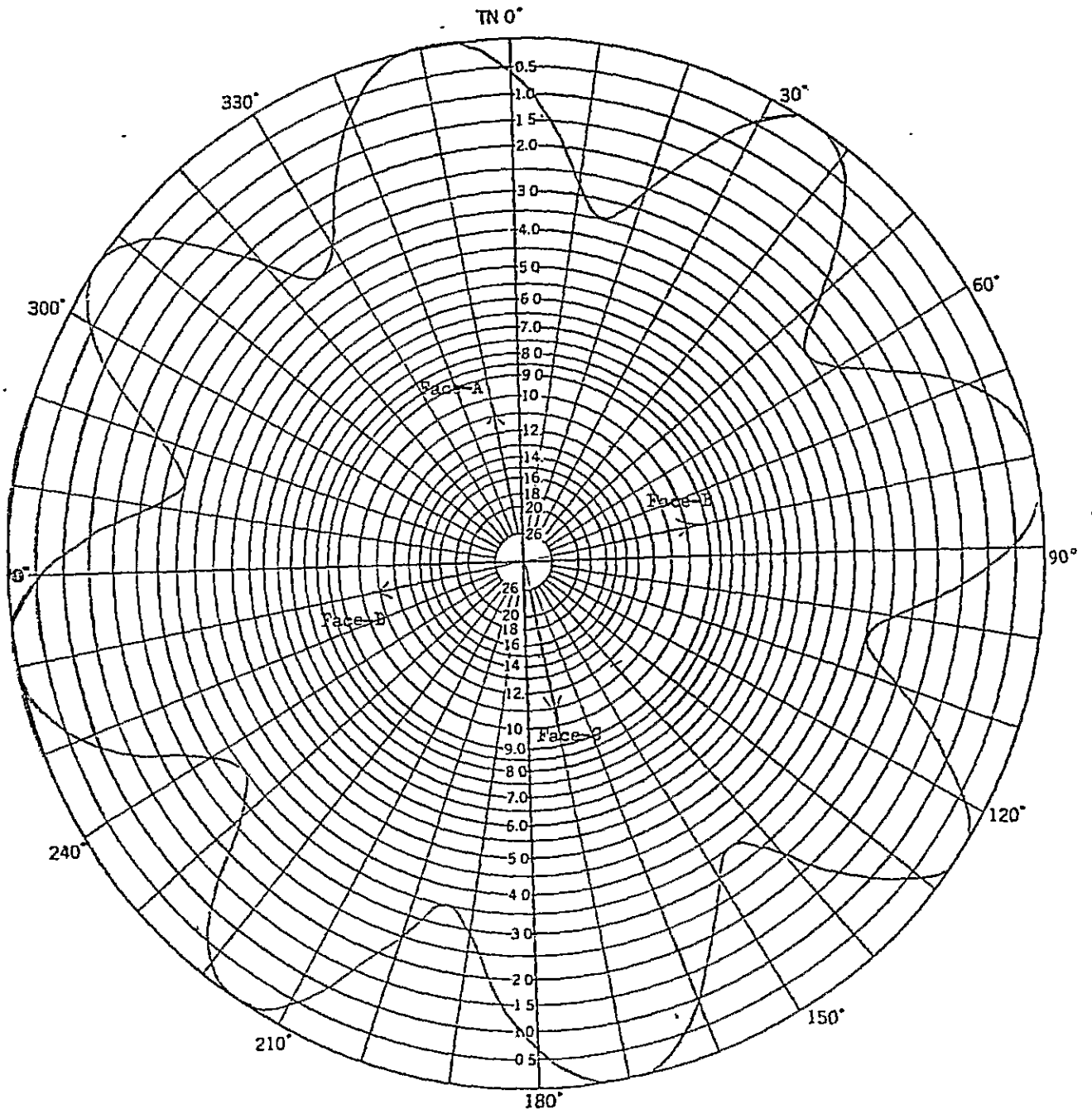

Fig 3 - 2

Horizontal pattern (ideal) for
KOKAVIL Transmitting station

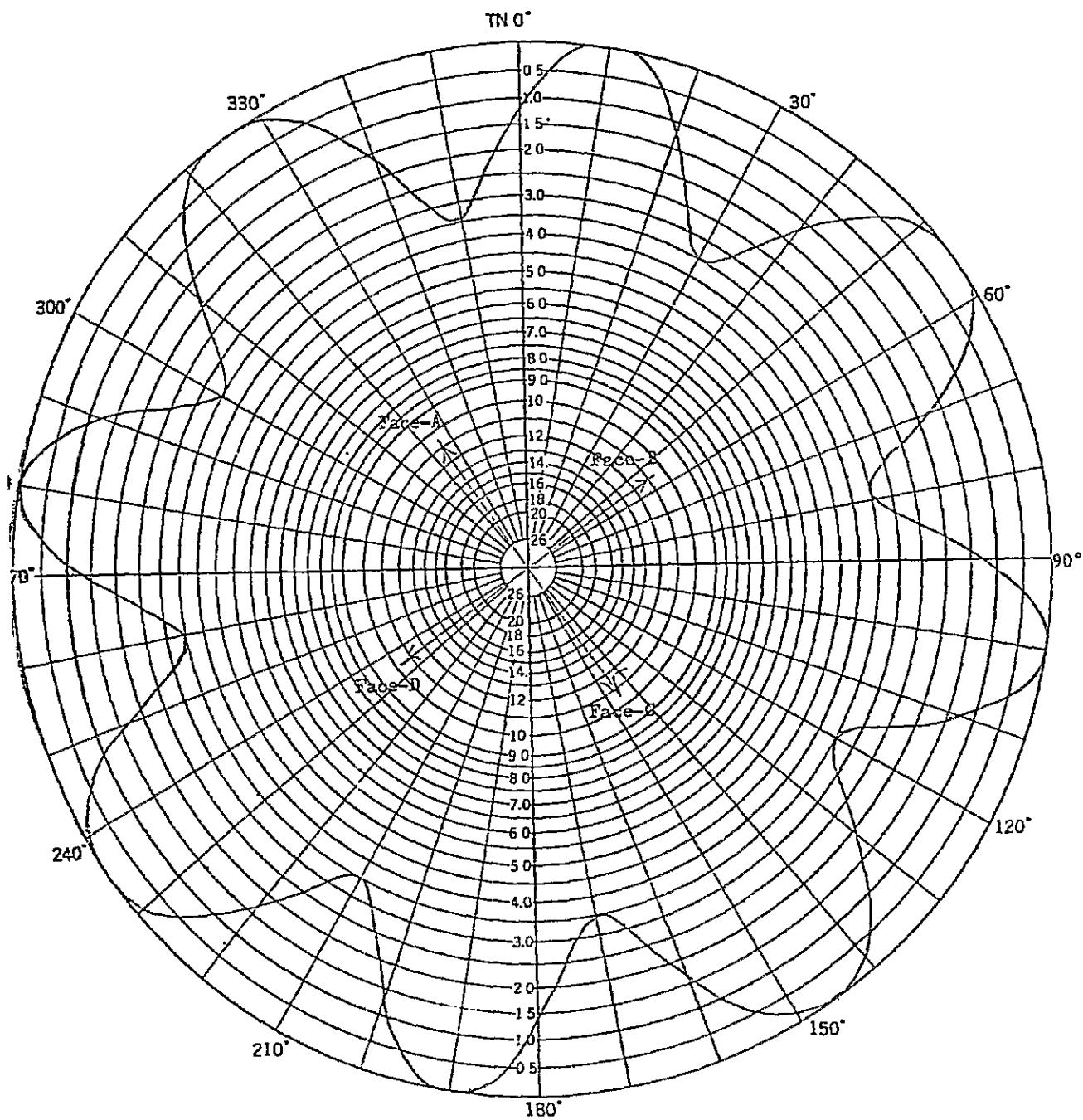

Fig 3 - 3

Horizontal pattern (ideal) for
KANDY Transmitting station

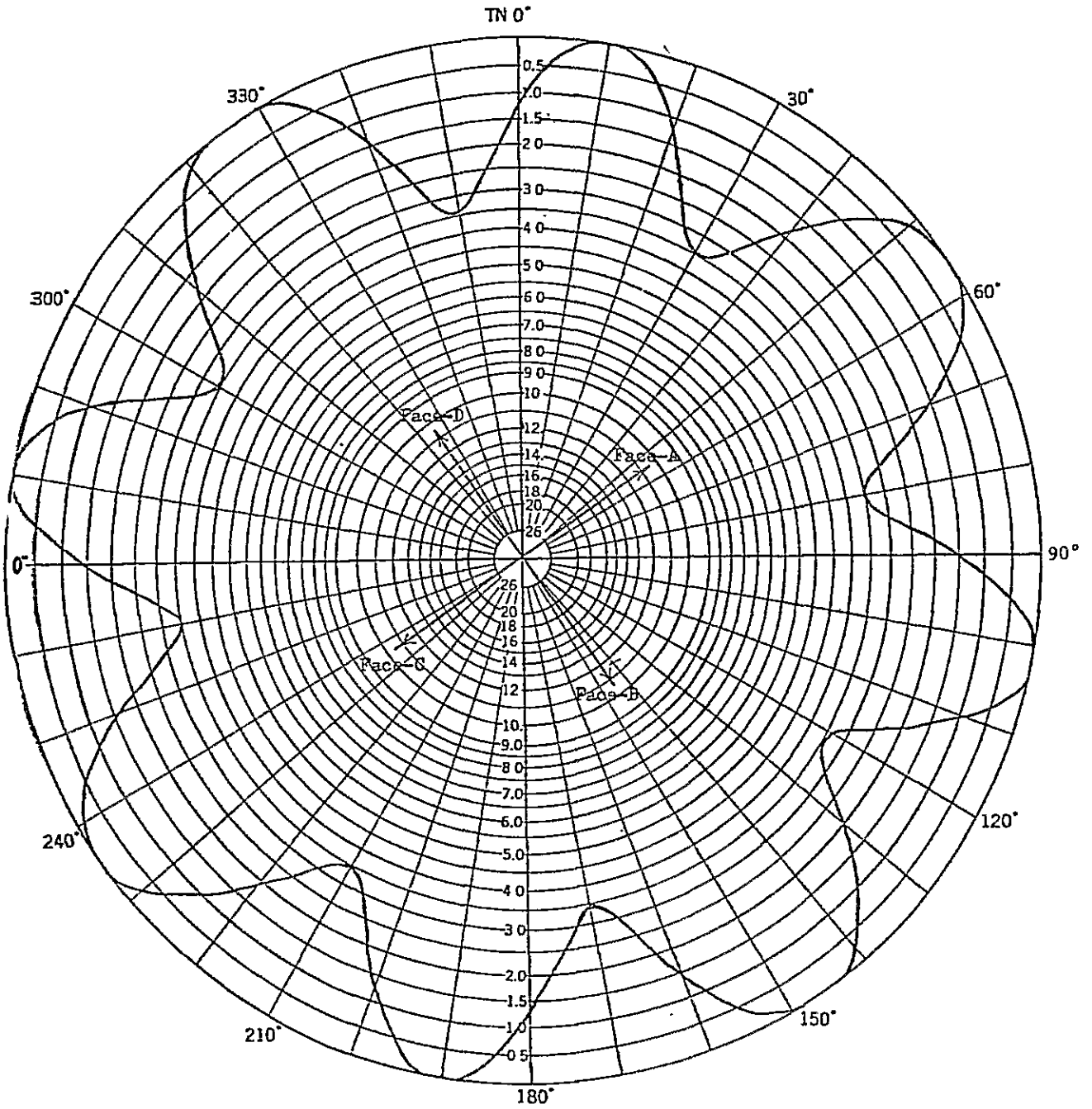

Fig 4 - 1

Vertical pattern (ideal) for
Mt. PIDURUTALAGALA Transmitting station

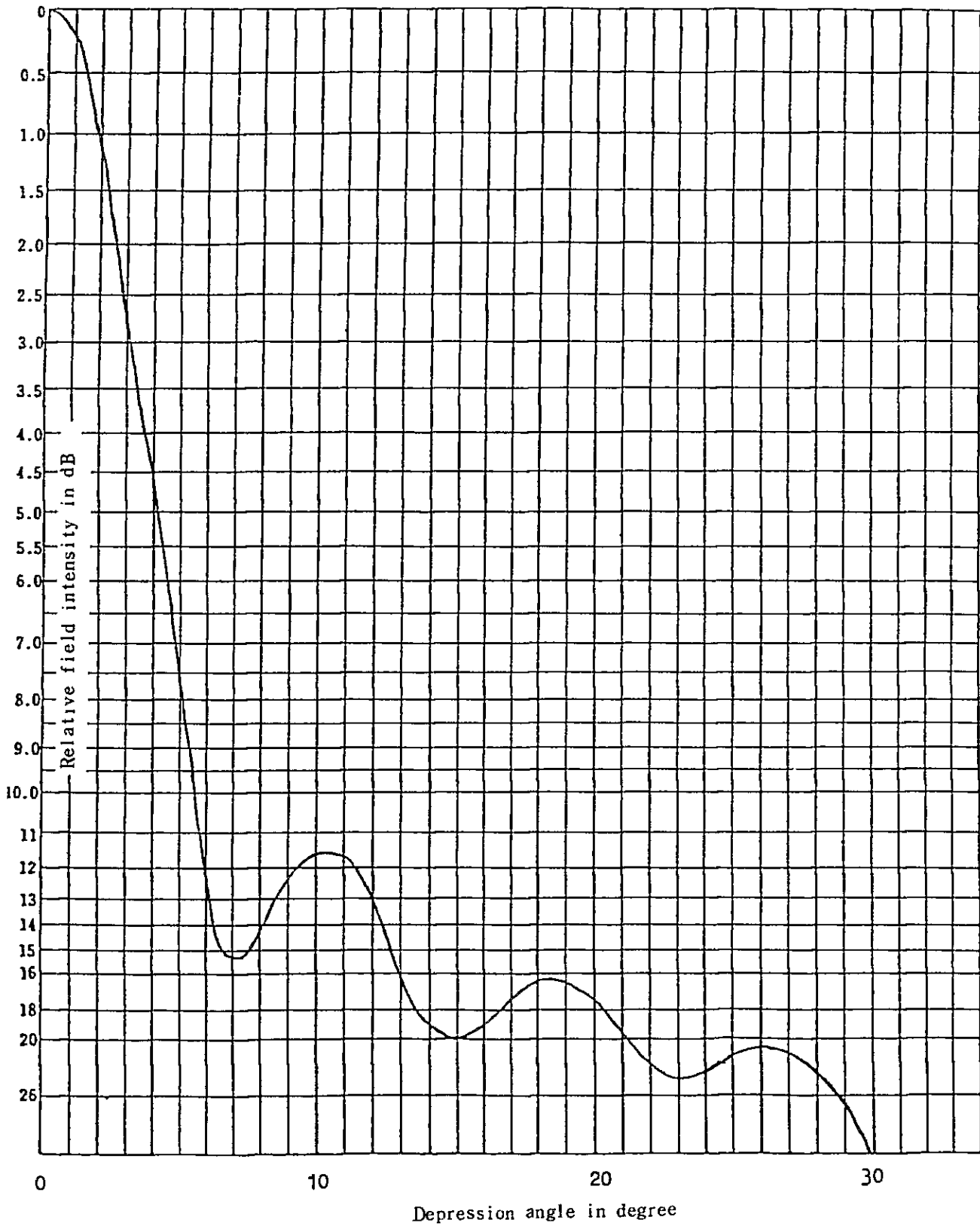

Fig 4 - 2

Vertical pattern (ideal) for
KOKAVIL Transmitting station

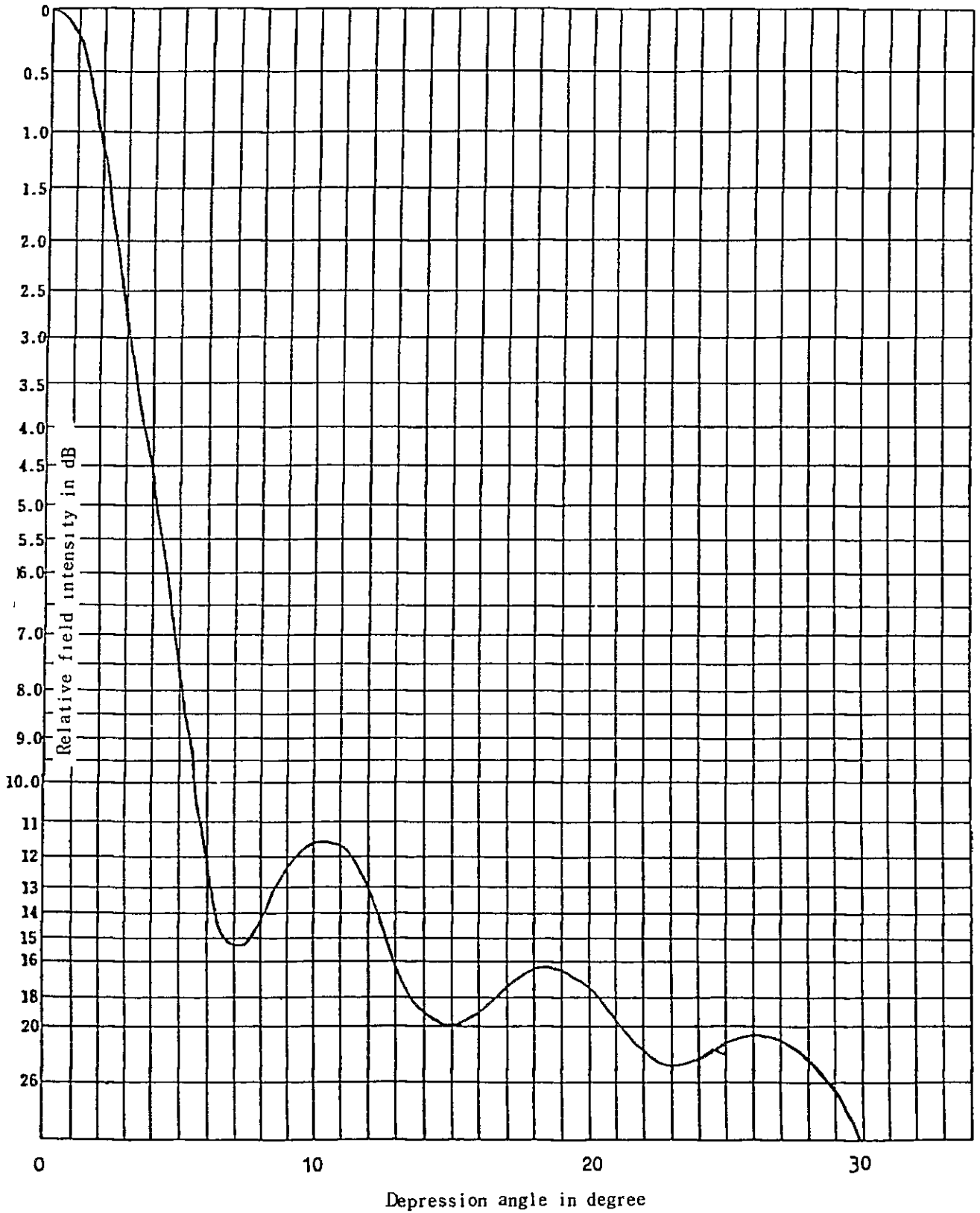

Fig 4 - 3

Vertical pattern (ideal) for
KANDY Transmitting station

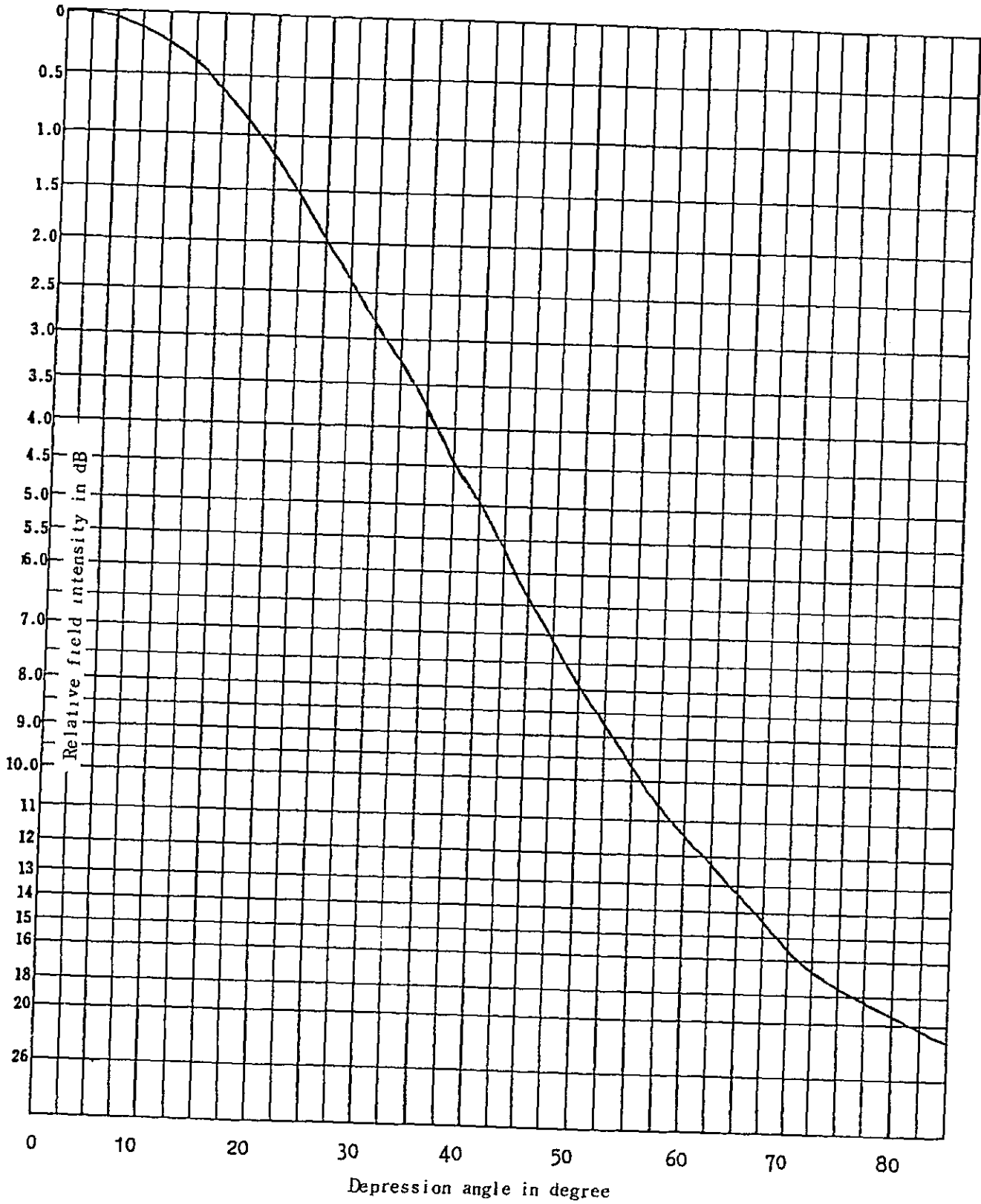

Table 3-1 CALCULATION OF EFFECTIVE RADIATED POWER
for Transmitting Antenna System
at PIDURUTALAGALA Station

Proposed Antenna System : 4 Dipole Antenna 4 stacks, 4 faces	
: Main Feeder HF-77D 60m x 2 (dual run)	
Transmitter Output Power : 20 kW (visual sync. peak, V/A ratio=10/1)	
CALCULATED VALUES	
Gain of each panel	+10.8 dB
Gain of stack	+6.0 dB
Power dividing loss	-6.0 dB
Null filling loss	<u>-0.3 dB</u>
Antenna Gain (antenna proper)	+10.5 dB
Main Feeder loss	<u>-0.3 dB</u>
Actual Antenna Gain (including feeder loss)	+10.2 dB
Transmitter Power	<u>+13.0 dBK</u>
	+23.2 dBK
E.R.P.	<u>approx. 210.0 KW</u>

Table 3-2 CALCULATION OF EFFECTIVE RADIATED POWER
for Transmitting Antenna System
at KOKAVIL Station

Proposed Antenna System : 4 Dipole Antenna 4 stacks, 4 faces	
: Main Feeder HF-77D 120m x 2 (dual run)	
Transmitter Output Power : 20 KW (visual sync. peak, V/A ratio=10/1)	
CALCULATED VALUES	
Gain of each panel	+10.8 dB
Gain of stack	+6.0 dB
Power dividing loss	-6.0 dB
Null filling loss	<u>-0.3 dB</u>
Antenna Gain (antenna proper)	+10.5 dB
Main Feeder loss	<u>-0.6 dB</u>
Actual Antenna Gain (including feeder loss)	+9.9 dB
Transmitter Power	<u>+13.0 dBK</u>
	+22.9 dBK
E.R.P.	<u>approx. 195 KW</u>

Table 3-3 CALCULATION OF EFFECTIVE RADIATED POWER
for Transmitting Antenna System
at KANDY Station

Proposed Antenna System : 2 Dipole Antenna 1 Stack, 4 Faces
: Main Feeder CF-10D 40m
Transmitter Output Power : 50 W (visual sync. peak, V/A ratio=10/1)

CALCULATED VALUES

Gain of each panel	+7.8 dB
Gain of stack	0 dB
Power dividing loss	-6.0 dB
Null filling loss	<u>0 dB</u>
Antenna gain (antenna proper)	+1.8 dB
Main feeder loss	<u>-1.1 dB</u>
Actual Antenna Gain (including feeder loss)	+0.7 dB
Transmitter Power	+17.0 dB
	<u>+17.7 dB</u>
E.R.P.	<u>approx. 60 W</u>

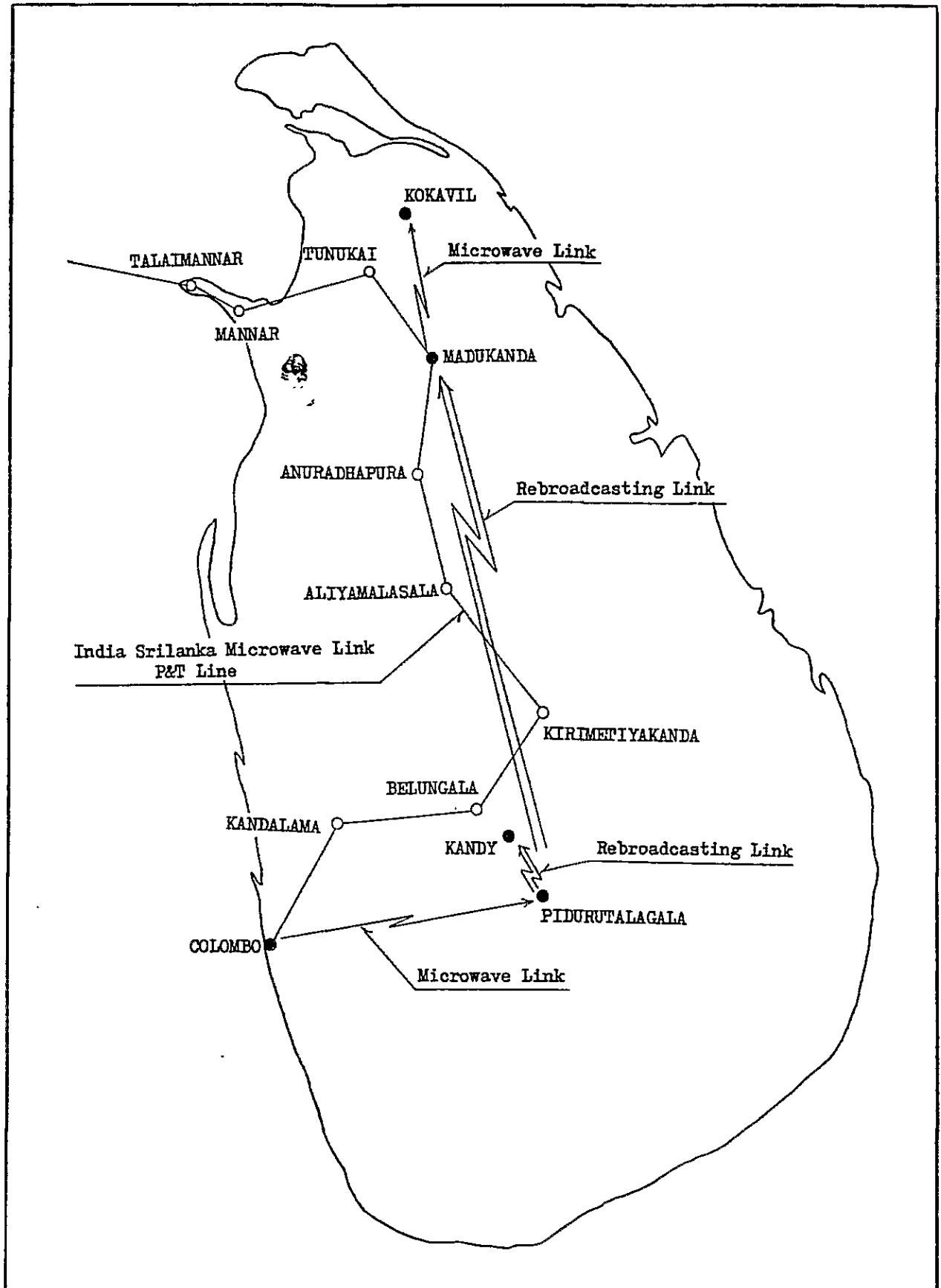

Fig5-1 MAP OF TELEVISION BROADCASTING NETWORK (1)

KOKAVIL
Transmitting Station

60 Km

MADUKANDA
Repeater Station

200 Km

KANDY Transmitting
Station

35 Km

Mt. PIURUTALAGALA
Transmitting Station

102 Km

COLOMBO Studio

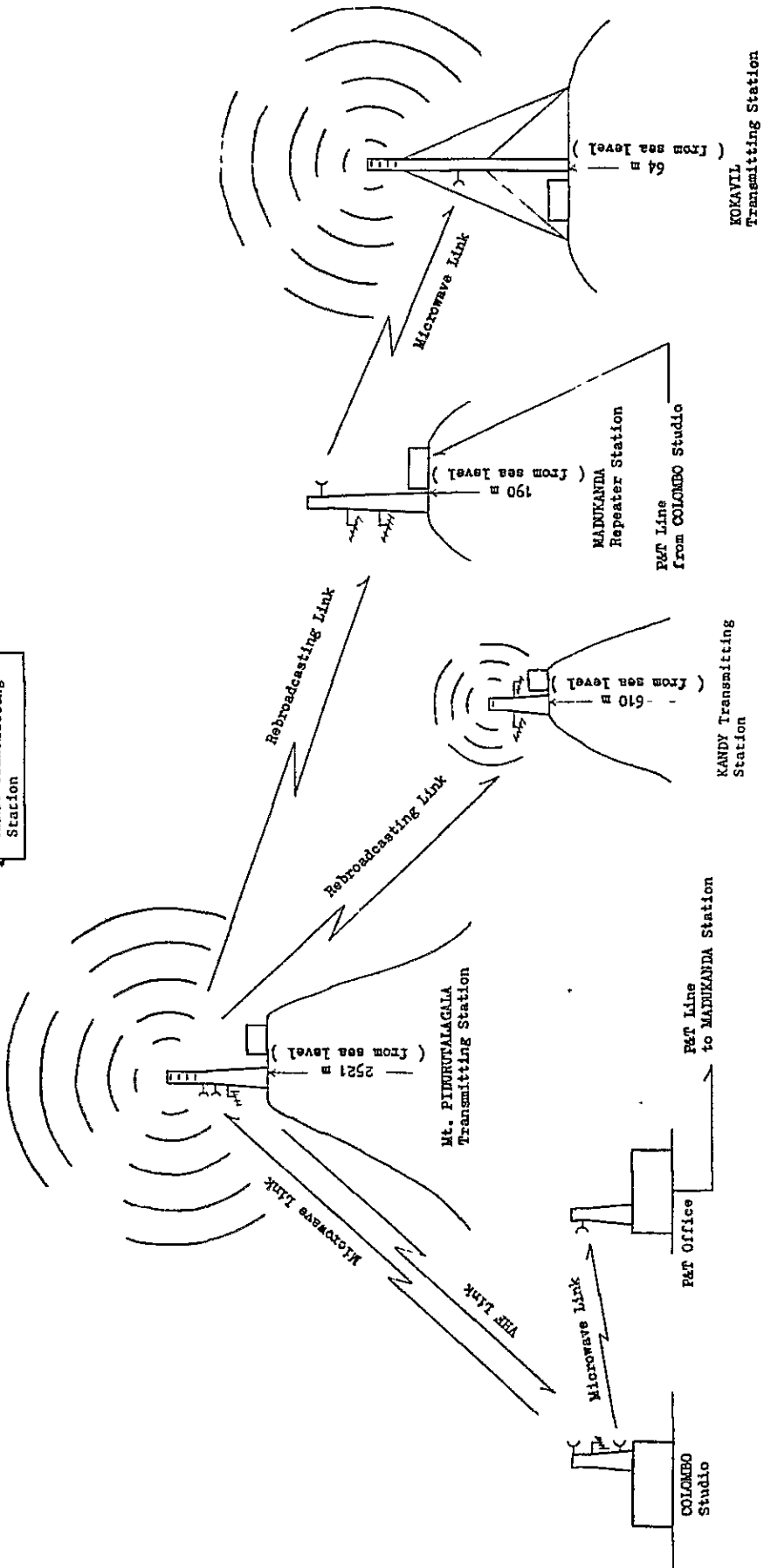

KOKAVIL
Transmitting Station

MADUKANDA
Repeater Station
P&T Line
from COLOMBO Studio

KANDY Transmitting
Station

Mt. PIURUTALAGALA
Transmitting Station

P&T Line
to MADUKANDA Station

P&T Office

COLOMBO
Studio

FIG. 5-2 MAP OF TELEVISION BROADCASTING NETWORK (2)

($K = \frac{4}{3}$)

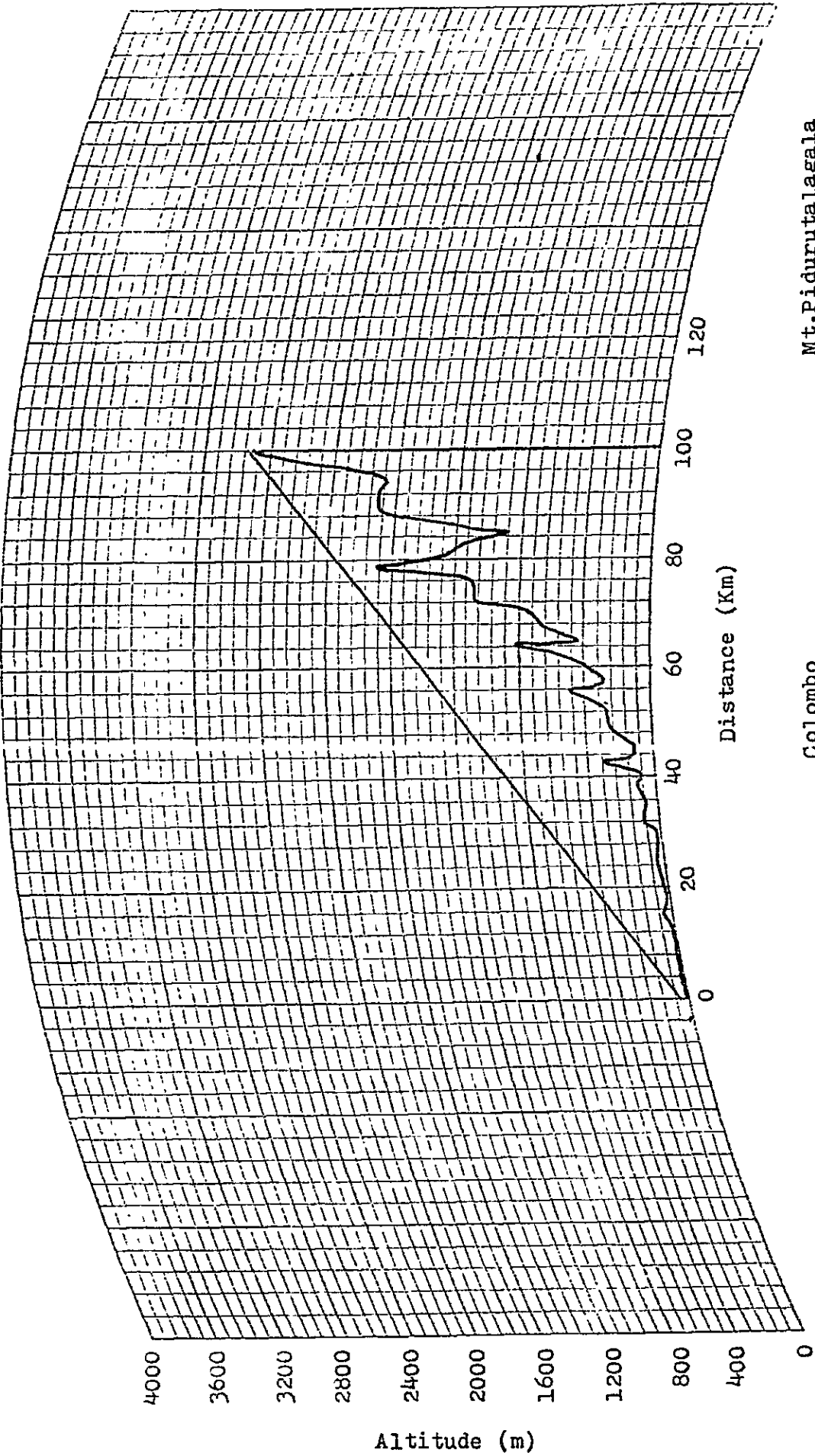

Colombo	Mt. Pidurutalagala
Altitude, 5m	Altitude, 2518m
Antenna Height, 40m	Antenna Height, 25m

Fig. 6-1 Profile Map of Microwave Link (1)

(K = 1/4)

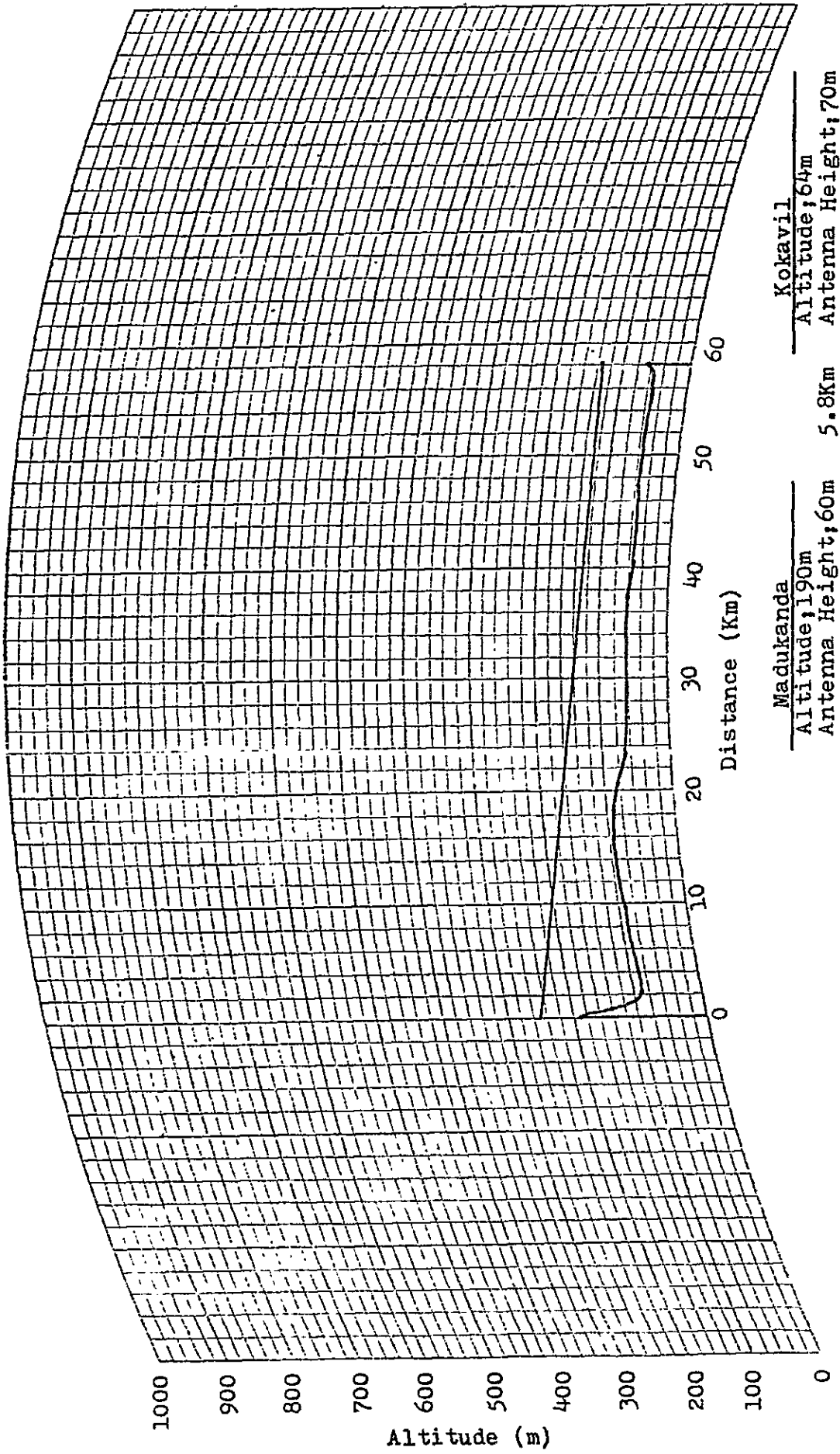

Fig. 6-2 Profile Map of Microwave Link (2)

SECTION 2 FACILITY PLAN

2-1 Broadcast Equipment

2-1-1 Studio Facilities

The outline of the studio facilities is as follows:

(1) Studio room facilities

Two TV studio rooms will be provided: one as wide as about 200 m² and the other about 100m².

The 200 m² studio room will be furnished with three (3) colour cameras to be used in common with the outdoor-broadcast van (OB van), and manual button type lighting facilities. A subcontrol room (studio control room) will be provided but, at the first stage, it will be furnished with no video and audio control facilities, the facilities on the OB van will be used for programme production.

The 100 m² studio room will be furnished with two (2) cameras and suspension type lighting facilities using slide rails. The subcontrol room will be furnished with camera control equipment, a video switching console, a sound mixing console, sound taperecorders, a disk player, a lighting control console, etc.

(2) Master control room facilities

A master control console will be provided to conduct switching/connection of sound and video programmes recorded by VTR, etc., switching of TV programmes, control of programme transmission from field pick up links (FPU) between the studio and Overseas Telecommunications Service (OTS) and between the studio and Post and Telecommunications Bureau (P & T) and programme transmission to Mt. Pidurutalagala Transmitting Station.

(3) Telecine equipment

For telecine equipment, 16 mm film projectors, 35 mm film projectors, 35 mm slide projectors, opaque card projectors, and colour cameras will be furnished. This allows broadcasting 16 mm and 35 mm films, 35 mm slides, and opaque cards (or telops) of 10 cm x 12.5 mm photographs and cards containing characters and graphs to be broadcast in colour. The use of opaque card projector allows cards containing graphs and characters in a given card size to be broadcast with ease effective for broadcasting still pictures.

(4) VTR facilities

The use of VTRs allows recording and reproduction of colour TV programmes.

The type of VTR to be adopted should be selected in consideration of the performances, such as picture quality and stability, interchangeability of tapes for exchange of programmes, availability of consumable component parts, such as VTR heads, and repair scheme.

Two sets of VTRs will be employed in consideration of programme editing by VTRs. The VTR sets will have simple editing capabilities such as "cutting" and SLE (splice-less editor) functions.

VTRs generally used at broadcasting stations these days allow a maximum of about 90 minutes of continued recording or reproduction.

(5) Outdoor programme production and news gathering facilities

For outdoor programme production and news gathering, an OB van and ENG (Electronic News Gathering) unit will be provided.

The OB van will be furnished with three (3) colour cameras, video and audio equipment, and FPU equipment. For the ENG, a hand-held camera, cassette VTR, etc., will be mounted on the OB van.

The facilities of the OB van will also be used as subcontrol facilities for the 200 m² studio room.

(6) Power facilities

Commercial AC power will be used as the power source.

In particular, power for broadcast equipment will be provided through an automatic voltage regulator.

The film projector of telecine, cinecoder, etc., using synchronous motors will be fed from a separate CVCF (constant-voltage constant-frequency) power supply.

Studio lighting facilities will require as large power as about 180 KV.

Thus a total power capacity of about 300 KVA (350 KVA in contract capacity) will be required including power for general use, motor-driven equipment use, and miscellaneous use.

An engine generator for emergency use will also be provided.

Table 8 and Fig. 7 show the main facilities and equipment to be provided for the studio facilities.

Table 8 Main Facilities and Equipment

Classification	Facilities or Equipment
TV Studio 1	Studio floor (about 200 m ²) Color cameras (common with OB van) ... 3 sets Studio lighting facilities Monitoring equipment (common with OB van) Microphones (common with OB van)
TV Studio 2	Studio floor (about 100 m ²) Color cameras 2 sets Studio lighting facilities Monitor equipment Microphone
Subcontrol equipment 1	Used in common with OB van Lighting control panel Monitoring equipment
Subcontrol equipment 2	Control console Monitoring equipment Tape recorder/reproducer Disk reproducer Video control rack Lighting control panel
Master control equipment	Master control console Monitor facilities Audio equipment rack Sync signal rack and distributors Video equipment rack
Telecine VTR	Color telecine and opaque projector rack 2 sets Color VTRs 3 sets (one used in common with OB van)
Programme relay equipment	STL equipment FPU equipment
Programme production and news gathering	OB van 1 set
News gathering	Hand-held camera Cassette VTR Microphones
Maintenance equipment	Test equipment Repair equipment and materials
Power facilities	Automatic voltage regulator Emergency power supply (Engine generator)

2-1-2 Transmitting Station Facilities

The transmitting stations facilities will be as follows.

(1) Transmitter and aerial facilities

1) Mt. Pidurutalagala and Kokavil Transmitting Stations

Two 10 KW television transmitters will be employed for parallel operation at a resultant output power of 20 kW. Parallel operation will assure such reliable operation that when one of the transmitters fail, the broadcasting service can be continued at an output power 1/2 of the normal, by disconnecting the faulty transmitter.

For the transmitting aerial, four 4-dipole aerial panels will be employed for each of the four directions (A, B, C, and D), that is, a total of 16 panels will be employed.

2) Kandy Transmitting Station

A translator system consisting of two 50 W translators, one as stand-by, will be employed.

Each translator will be designed to be all solid-state in order to assure high reliability and labour reduction in maintenance.

One 2-dipole aerial panel will be used for each of the four directions (A, B, C, and D), that is, a total of 4 aerial panels will be employed.

(2) Power facilities

Commercial power will be used as the power source. In particular, power for broadcast equipment will be fed through an automatic voltage regulator. To raise the reliability of power supply, an emergency engine generator will be employed, thus for constituting two separate power systems. The total power capacities of Mt. Pidurutalagala, Kokavil and Kandy Transmitting Stations will be respectively 150 KVA, 150 KVA, and 3 KVA, including power for equipment use and miscellaneous use.

(3) Control and monitoring equipment

1) Mt. Pidurutalagala Transmitting Station (Unattended)

A remote control and monitoring equipment using radio links will be installed, and control and monitoring will be conducted at Colombo Studio.

2) Kokavil Transmitting Station (Attended)

A control and monitoring panel will be furnished to be operated by a monitoring engineer staying at this station.

3) Kandy Transmitting Station (Unattended)

A remote monitoring equipment using the existing telephone lines will be

installed for monitoring at Colombo Studio.

The control and monitoring items of the respective transmitting stations are given in the following tables.

Controls and Monitoring Items

Mt. Pidurutalagala Transmitting Station

Control Item	Monitoring Item
1. Switchover of Terminal Station	1. Fire, Door
2. Clamp AC, DC ON/OFF	2. Control, Automatic
3. No. 1 Transmitter, ON/OFF	3. Control, Remote
4. No. 2 Transmitter, ON/OFF	4. Indication, Retransmission
5. Emergency Engine Generator, Start	5. Carrier Frequency Terminal Equipment Abnormal
6. Emergency Engine Generator, Operating	6. Clamp AC, DC, Operating
7. Emergency Engine Generator, Stop	7. Transmitter Abnormal
8. Power Reception	8. Carrier Frequency Terminal Equipment 1, Operating
9. Control, Automatic/Remote	9. Carrier Frequency Terminal Equipment 2, Operating
10. Retransmission	10. No. 1 Transmitter Stand-by
	11. No. 2 Transmitter Stand-by
	12. No. 1 Transmitter, Operating
	13. No. 2 Transmitter, Operating
	14. Commercial Power Failure
	15. Power Facilities Abnormal
	16. Emergency Engine Generator, Operating
	17. Power Reception, Operating
	18. Emergency Engine Generator, Operating
	19. Control Lines Abnormal
	20. Indication Lines Abnormal
	21. Remote Control, Operating
	22. Remote Control Abnormal

Kandy Transmitting Station

Monitoring Items
1. Transmitter Failure
2. No. 1 Transmitter, Operating
3. No. 2 Transmitter, Operating
4. Mains Power Reception Failure
5. Power Facilities Abnormal
6. Emergency Engine Generator, Operating

Table 9-1 through 9-3 and Figs. 8-1 through 8-3 show the main facilities to be installed at each transmitting station. Examples of layout of transmitting stations and aerial configuration are respectively shown in Figs. 9-1 through 9-3 and Figs. 10-1 through 10-3.

2-1-3 Programme Rebroadcasting Facilities

(1) Mt. Pidurutalagala Transmitting Station

Programmes produced at the studio will be transmitted to Mt. Pidurutalagala Transmitting Station, about 100 km away from the studio site, by means of an STL (Studio-Transmitter Link). Two 7GHz-band 10W transmitters will be provided to form a stand-by transmitting system. Likewise, two receivers will be used to form a stand-by receiving system. By using a 4m ϕ parabolic aerial at the studio site and a 4m ϕ parabolic aerial of space diversity type, at the transmitting station, a high-performance link will be established.

The above-mentioned STL is considered to transmit not only video and audio signals but also superimposed control signals. A TSL (Transmitter-Studio Link) will be established for communication from the transmitting station to the studio and monitoring of the transmitting station at the studio. The TSL will use a 160 MHz-band 10W transmitter with no standby transmitter, and a Yagi aerial.

(2) Kokavil Transmitting Station

Programme transmission to Kokavil Transmitting Station will be made through Madukanda Repeater Station. A 7GHz-band self-managed microwave link will be established between Madukanda Repeater Station and Kokavil Transmitting Station, provided with a stand-by transmitter and receiver equipment. The transmitter output power will be 5W. A 4m ϕ parabolic aerial will be used.

(3) Madukanda Repeater Station

Video and audio signals will be obtained by receiving the broadcast signals of Mt. Pidurutalagala Transmitting Station, until the Indo-Sri.Lanka Microwave System is completed. For this purpose, two receivers of a stand-by system and two 12-element Yagi aerials of space diversity type will be installed at this station.

For the power facilities, commercial power source and an emergency engine generator will be employed to assure high reliability in power supply. The power capacity will be about 1KVA, and an automatic voltage regulator will be used for broadcast equipment.

(4) Kandy Transmitting Station

On account of the topographical and economical conditions, Kandy Transmitting Station will rebroadcast programmes of Mt. Pidurutalagala Transmitting Station. This station will employ a 12-element Yagi aerial for diversity reception. A schematic diagram of microwave links between Mt. Pidurutalagala Transmitting Station, Kokavil Transmitting Station, and Madukanda Repeater Station are shown in Figs. 11-1 and 11-2. Main facilities of Madukanda Repeater Station are given in Table 10, and floor layout of Madukanda Station is shown in Fig. 12. The receiving aerial system of Kandy Transmitting Station is shown in Fig. 13.

2-2 Buildings

2-2-1 Studio

(1) Site

Location: Torrington Square Colombo 7.

The expected site for the television studio is facing the road and in front of the building of Sri Lanka Broadcasting Corporation. At present, the site is used as a Hockey ground with related facilities. This proposed site meets the following conditions and is suitable for a television studio.

- 1) The site is near the radio station building.
- 2) A considerable wide area can be obtained by arrangement.
- 3) The site is near the urban district and the traffic is convenient.
- 4) The site is facing to two roads, assuring ease of access by personnel and vehicles and convenience for carrying in and out equipment and materials.
- 5) Main pipes for gas, water, and drainage are layed under the roads.

However the following requirements should be met before constructing the

studio building.

- 1) The hockey ground and related facilities should be relocated to another place.
- 2) At present, the depth of the site area may be somehow insufficient to meet the requirement of building layout. Such shape and area of site that are shown in the attached layout drawing should be provided in consideration of possible future expansion of the studio building.
- 3) At present, the ground level of the site is lower than that of the road in the front. Banking and leveling should be effected until the site will become at least in level with the road.

For making a detailed design, it is necessary to survey the soil structure in advance and provide necessary data for the structural planning of the studio building and steel tower. See Fig. 14-1.

(2) Building

In planning building construction, the following basic principles were set out.

- 1) At the initial stage for starting television broadcasting, the studio building should be rather small in scale and be furnished with basic facilities, for programme production and transmission.
- 2) Two studio rooms, studio 1 with a floor area of about 200 m² and studio 2 with a floor area of about 100 m², will be provided at the initial stage in consideration of the broadcasting hours and the contents of programmes to be broadcast.
- 3) Studio 1 will be used for producing medium-scale programmes such as drama, music, housekeeping, and programmes for audience to participate, whereas studio 2 will be provided with considerable flexibility in programme production and allow production of up-to-date programmes, such as news, wide programmes, and report programmes.
- 4) Studios 1 and 2 will be furnished with necessary facilities for programme production, such as fixed cyclorama, gas and water supply and drainage facilities.
- 5) By utilizing the advantage of being located near the existing radio station building, such facilities of the radio station that can be used in common for television broadcasting should be used as much as possible, and office room, manager's room, store house, etc., should not be provided in double.
- 6) The studio building should be located in order to reduce the path of flow of those concerned, by facing the entrance of the building to that

of the radio station across the road, and in consideration of smooth flow of men, vehicles, equipment and materials, etc., from or to both facing roads of the studio building.

- 7) The layout of the building in the site should be designed in consideration of future expansion of the studios and others. Necessary consideration should be given in structural design, anticipating expansion on the roof as much as possible (on for example, the roof of the office room).
- 8) Construction materials to be used should be those available in Sri Lanka and convenient for maintenance, so far as they do not provide functional disadvantages when used for the studio building. Construction method, structure, and design of the building should be determined in consideration of the climate, culture, and custom of the country.
- 9) The site is in a comparatively quiet environment. Although the building will somehow be subject to noise of vehicles, proper measures should be taken in designing the studios.
- 10) Airconditioning facilities should be provided separately for the studio rooms, control rooms, VTR & Telecine room, and performers' rooms, etc. See Figs. 14-2 and 14-3.

(3) Steel tower

A selfsupporting steel tower of 35 meters in height will be constructed on the studio building. This steel tower will mount a 4m ϕ parabolic aerial for STL use, a 1.2m ϕ parabolic aerial for link use, and an 8-element Yagi aerial for TSL use. On the top of the tower, a footpace (platform) will be provided to mount a 0.6 m ϕ manual-operated parabolic aerial for FPU use. The design of the aerial structure is to withstand a maximum wind velocity of 54m/sec. See Fig. 15-1.

2-2-2 Transmitting and Relay station

(1) Sites

1) Mt. Pidurutalagala Transmitting Station

Mt. Pidurutalagala is located in the north of Nuwara-Eliya Town and is the highest mountain in Sri Lanka (2524 meters above the sea). The top of this mountain is somehow long towards the east-west direction and flat. The north side abruptly falls down sharply, whereas the south side is moderately inclining. The usable flat area is mostly covered with grass and rocks are exposing on the west side. At present, there is only one climbing path to the mountain top. A vehicle road should

be constructed for transportation of construction machines and materials for the station building and also for transportation of equipment and materials, engine generator fuel, etc., after the broadcasting service is started. The road will be 3 meters in width, 7% in average inclination, and about 10 km in total length.

2) Kokavil Transmitting Station

This site is 64 meters above the sea and is located near a triangulation point, a little away from the "150" milestone of the national road (Route A-9). This site is situated along the road and provides no problem in transportation but in order to procure as large site area as shown in the attached drawing, deforestation (felling) will be required.

3) Kandy Transmitting Station

This site is about 600 meters above the sea and is situated at the south end on the hill which is sandwiched between the national road (route A-1) and the Reiver Mahaweli, which is ranging between Peradeniya and Kandy in the northeast direction. This site will provide no problem in transportation since the access road to the microwave repeater station is usable. A site area will also be available by ground leveling.

4) Madukanda Relay Station

This site is 190 meters above the sea and is located on a hill little away from the national road (Route A-9) and is near the existing microwave repeater station. The microwave repeater station has an access road, so that the site will have no problem in transportation. The proposed area involves many exposed rocks to be removed and deforestation (felling) will also be necessary. Facilities should be located not to hinder the existing microwave link.

For detail designing, it is necessary to make preparatory soil exploration and provide necessary data for the structural design of the station building and steel tower.

(2) Station buildings

The basic principle set out in paragraph 2-2-1, (2) "Building," item 8) should be adopted also to transmitting Station and relay station buildings.

1) Mt. Pidurutalagala Transmitting Station

This station will be designed to be an unattended station. The station will incorporate a transmitter room, engine generator room, a blower and exhaustor room, a small office room and a rest room for personnel

expected to be engaged in daily maintenance and inspection or emergency visit to the station. A water tank should be provided.

2) Kokavil Transmitting Station

This station will be designed to be an attended station. The station will require, in addition to the equipment room and others, similar to those of Mt. Pidurutalagala Transmitting Station, rooms and facilities for residing personnel. A water tank should also be provided without fail.

3) Kandy Transmitting Station

This station will be designed to be an unattended station. A water tank should also be provided.

4) Madukanda Relay Station

This station will be designed to be an unattended station. A water tank should also be provided. For floor plans of these stations, see Figs. 16, 17-1, 17-2 and 18 for reference's sake.

(3) Steel towers/masts

The height and structure of steel towers/masts to be constructed at the respective stations are given in the following table. The maximum wind velocity to be considered in structural design should be 54 m/sec.

Station	Height	Type	Aerial to be mounted
Mt. Pidurutalagala Transmitting Station	50m	Self-supporting type	4-Dipole aerial, 4 stages, Omnidirectional Two(2) 4m ϕ Parabolic aerals, One (1) Yagi aerial (8 elements)
Kokavil Transmitting Station	100m	Guyed-wire type	4-Diople aerial, 4 stages, Omnidirectional One (1) 4m ϕ Parabolic aerial
Kandy Transmitting Station	30m	Self-supporting type	2-Dipole aerial 1 stage, Omnidirectional Two(2) Yagi aerial (12 elements)
Madukanda Relay Station	30m	Self-supporting type	One (1) 4m ϕ Parabolic aerial Two (2) Yagi aerial (12 elements)

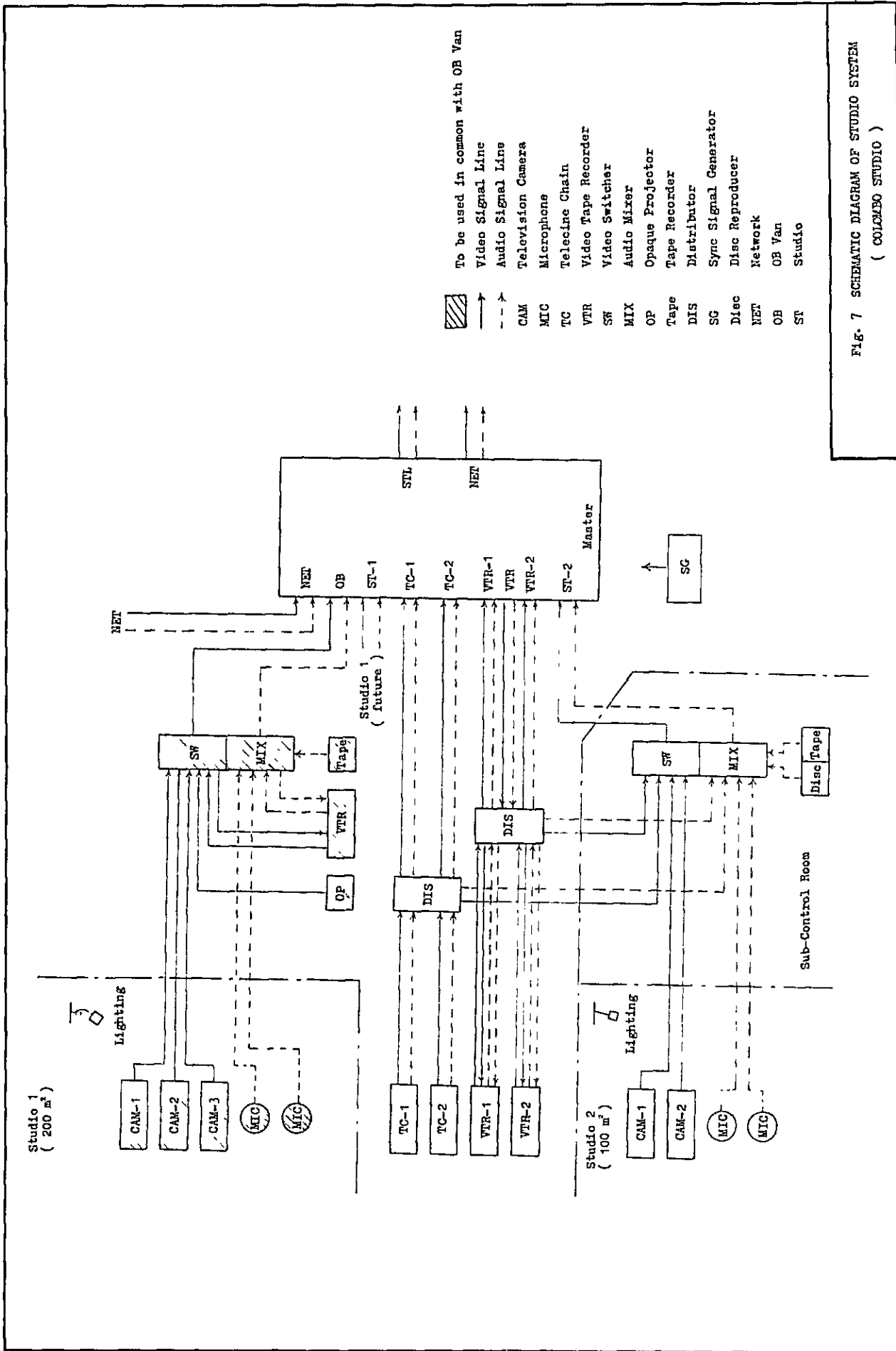

FIG. 7 SCHEMATIC DIAGRAM OF STUDIO SYSTEM
(COLOMBO STUDIO)

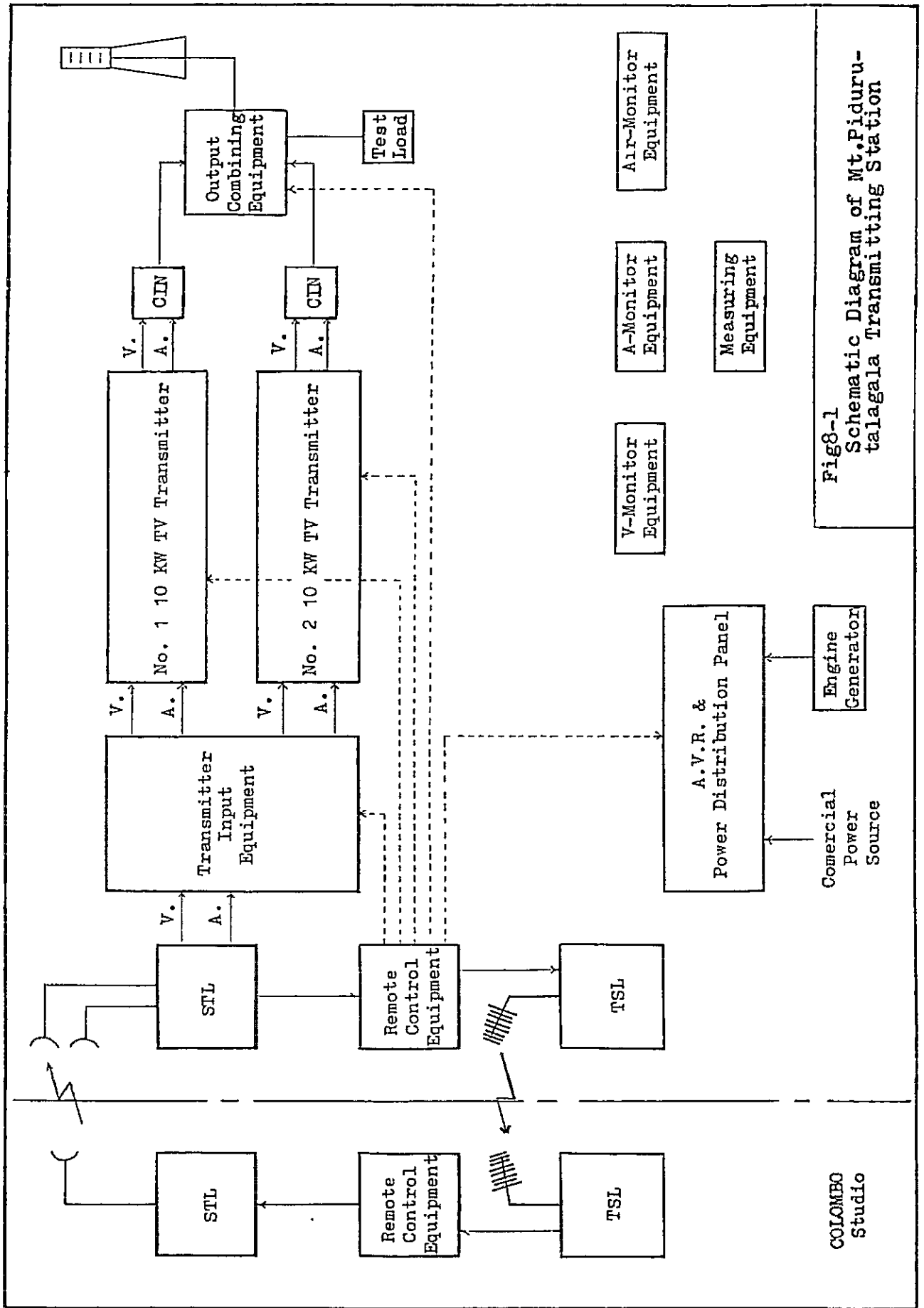

Fig8-1
Schematic Diagram of Mt. Pidurutalagala Transmitting Station

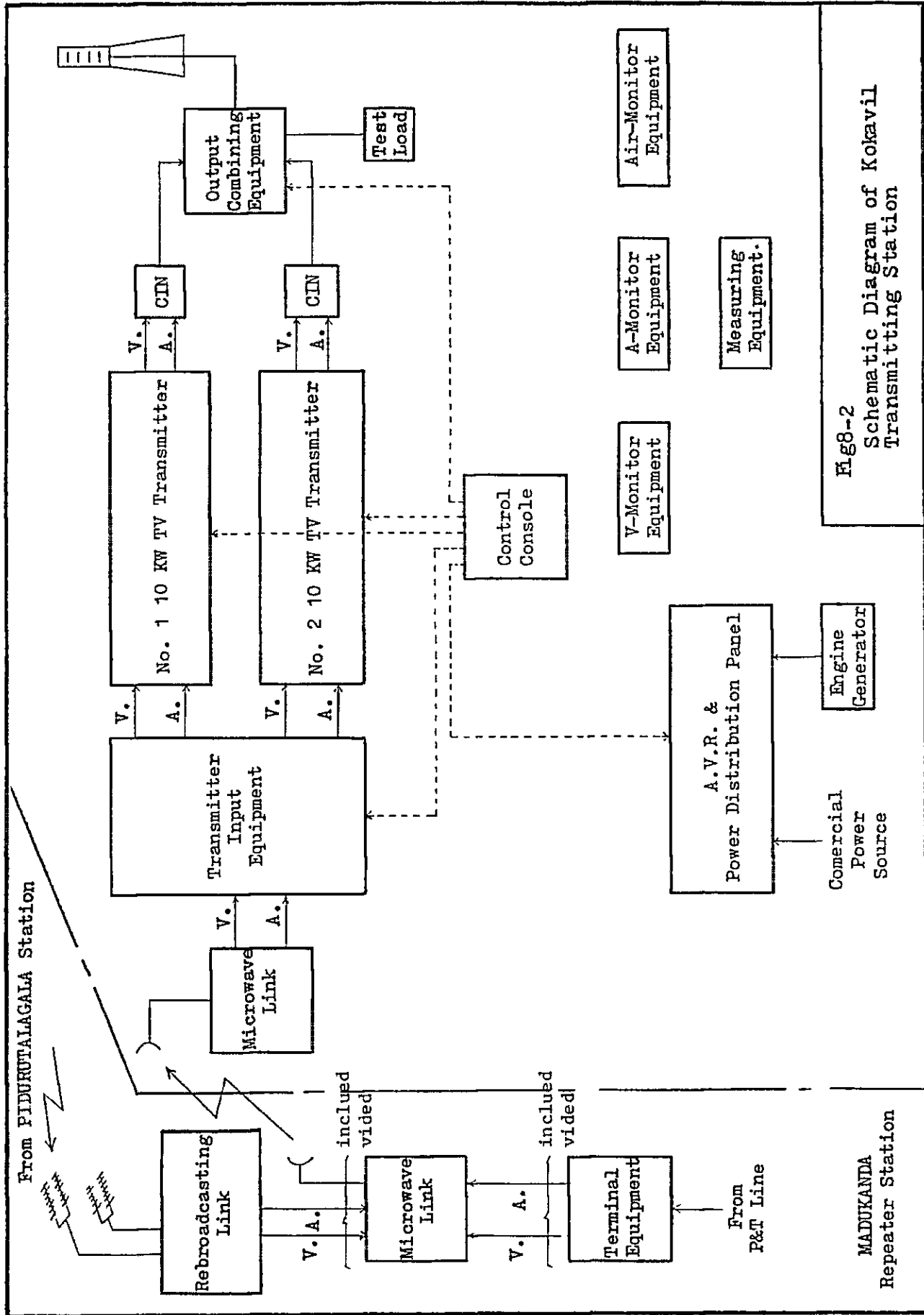

Fig 8-2
Schematic Diagram of Kokavil
Transmitting Station

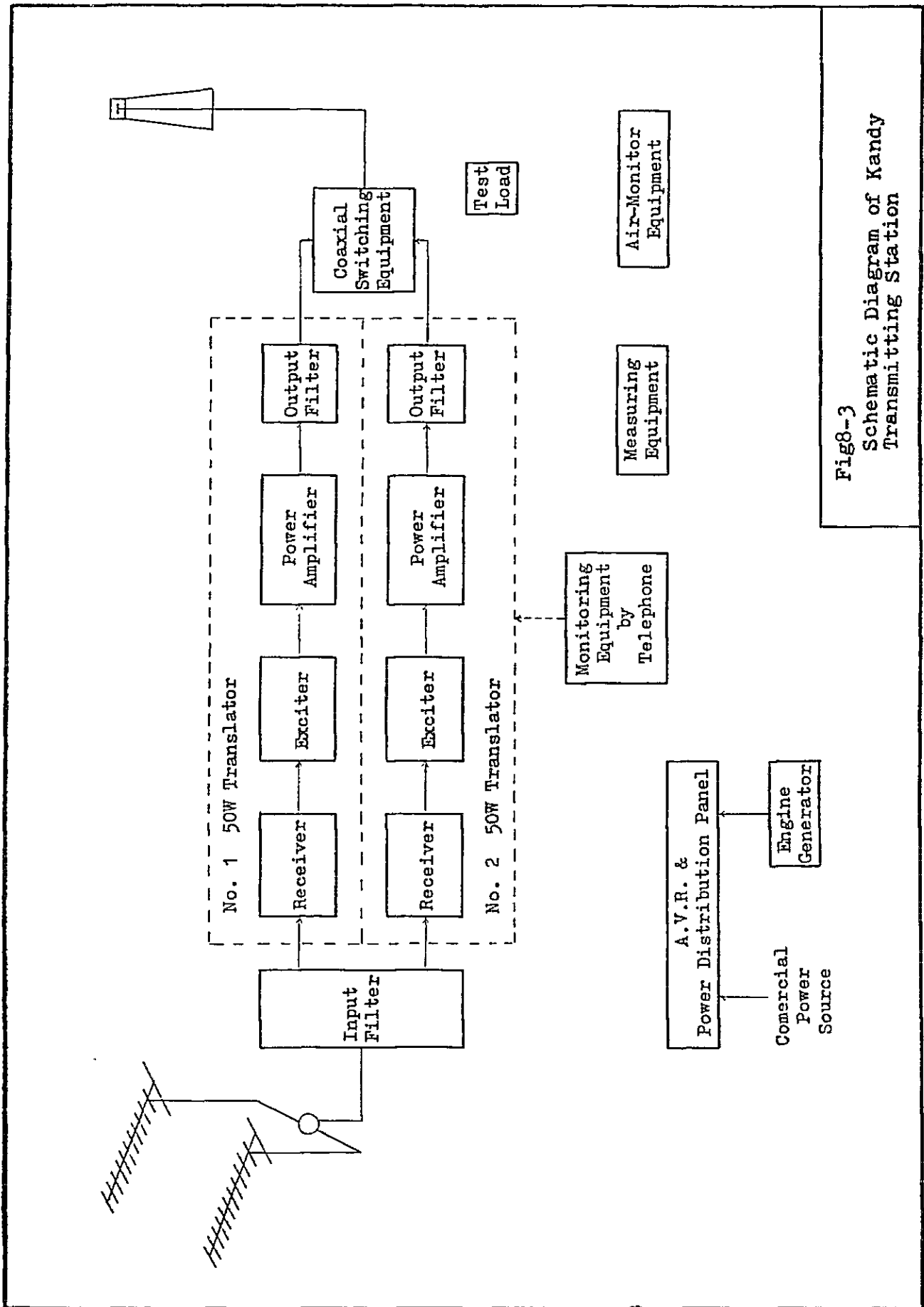
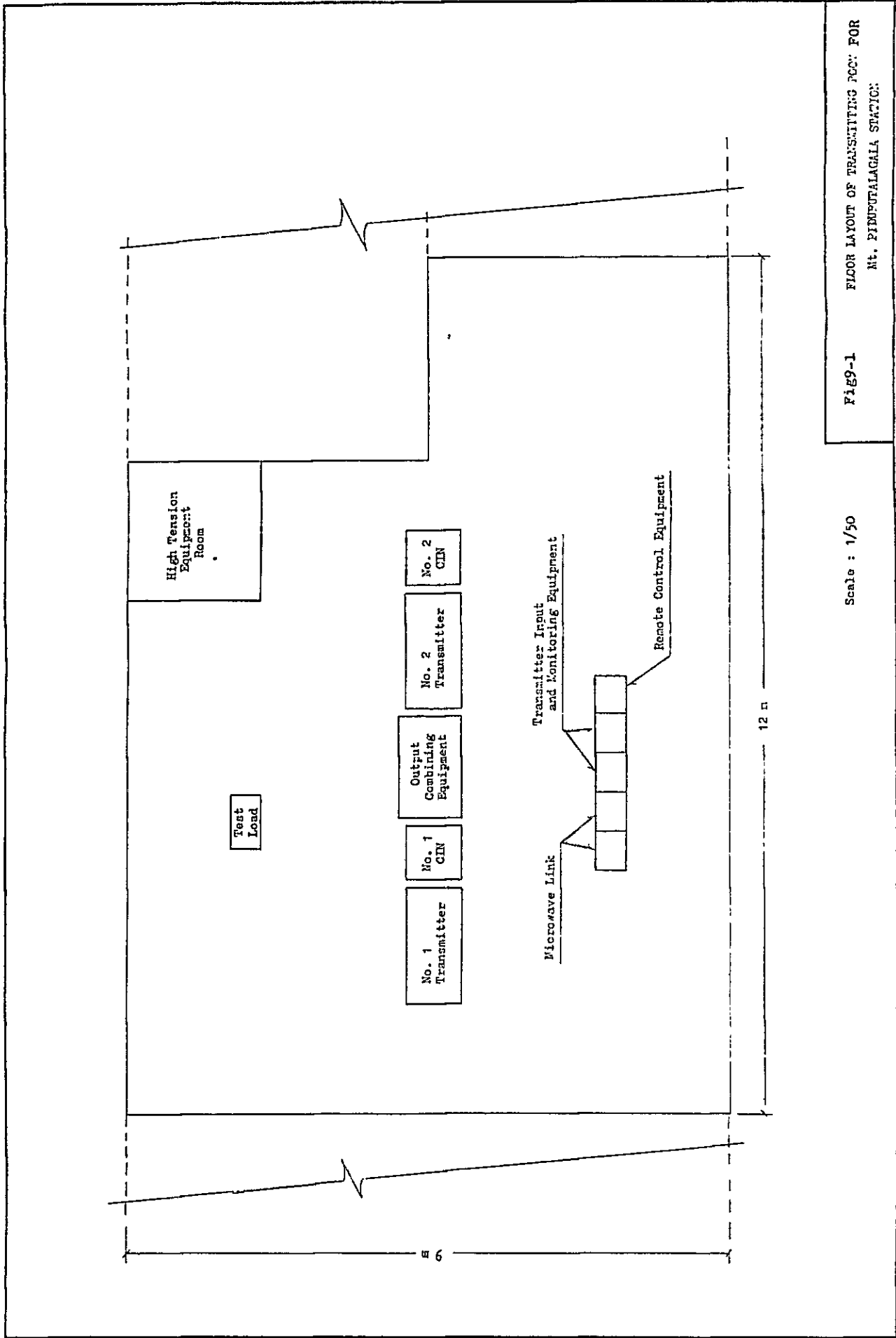

Fig8-3
Schematic Diagram of Kandy
Transmitting Station



Scale : 1/50

Fig9-1 FLOOR LAYOUT OF TRANSMITTING ROOM FOR Mt. PINATUBALAGALA STATION

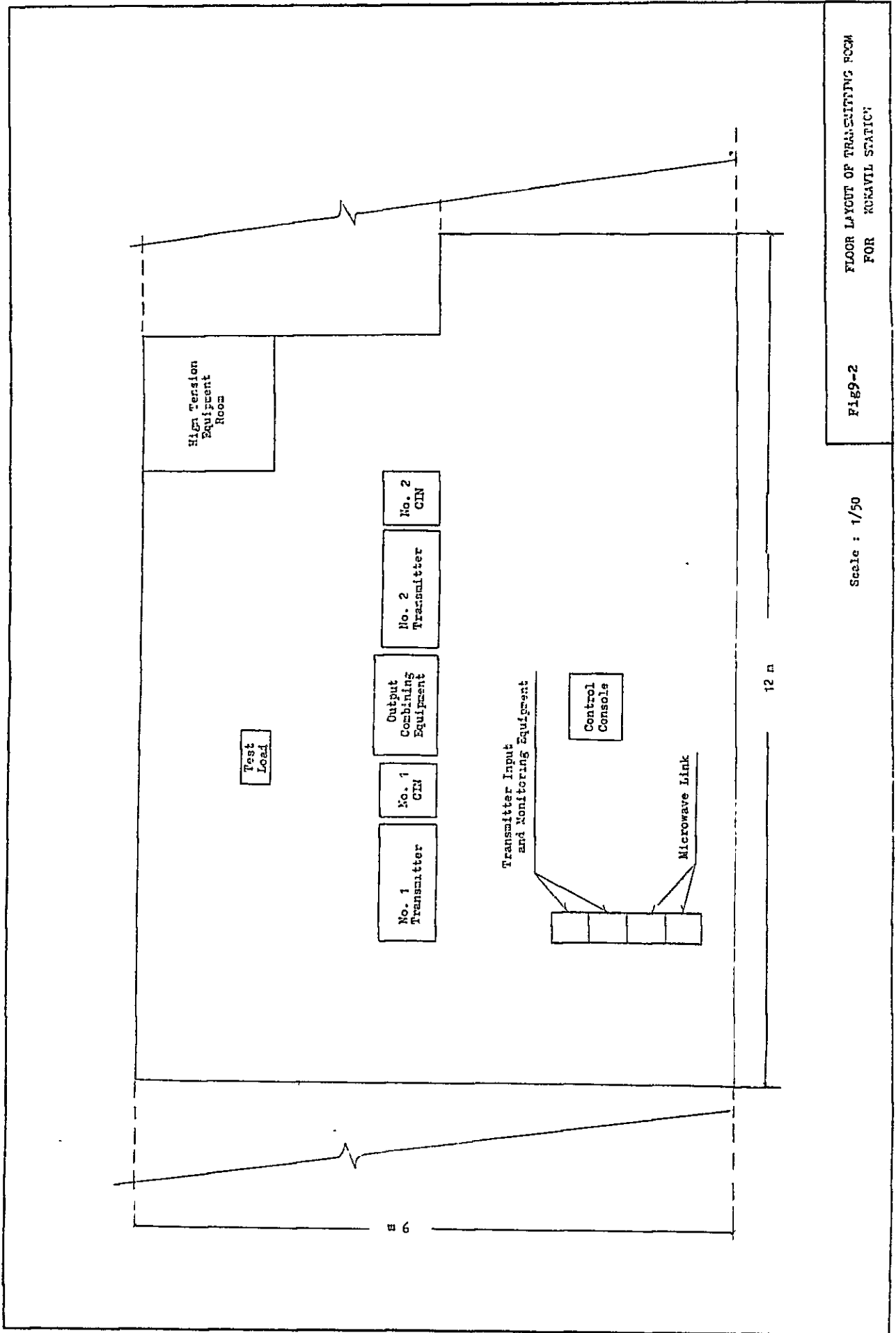
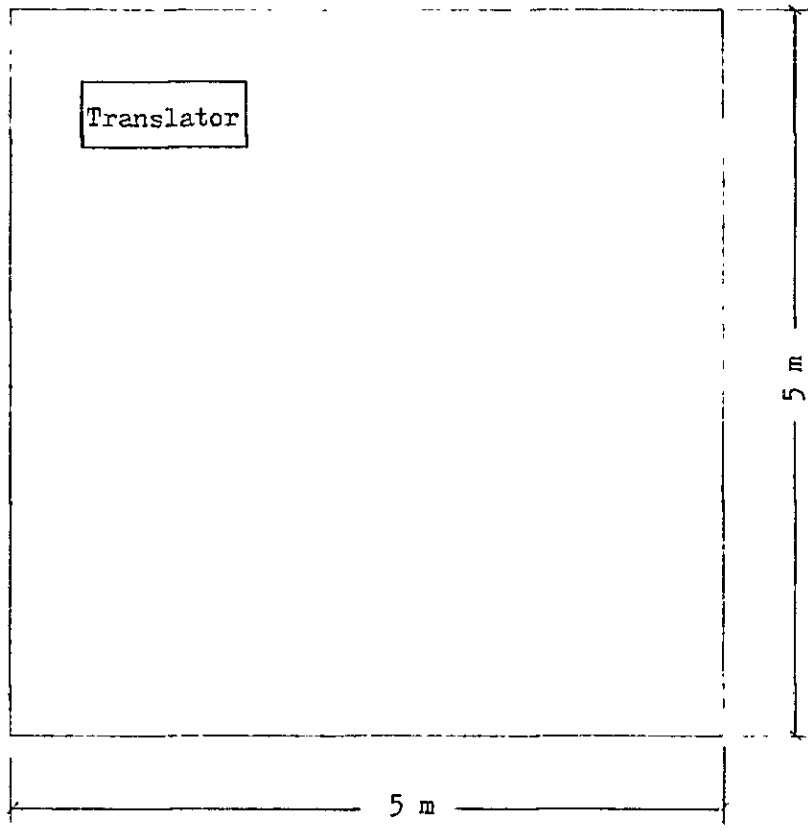

Fig 9-2 FLOOR LAYOUT OF TRANSMITTING ROOM FOR RUMAVIL STATION

Scale : 1/50



Scale : 1/50

Fig9-3

FLOOR LAYOUT OF TRANSMITTING ROOM
FOR KANDY STATION

Table 9-1 MAIN FACILITIES OF
Mt. PIDURUTĀLAGALA TRANSMITTING STATION

1. VHF Television Transmitter (Parallel Running)
 - 1.1 10 KW TV Transmitter 2 sets
 - 1.2 Transmitter Input Equipment
 - 1.3 Monitoring Equipment
2. TV Transmitting Antenna
 - 2.1 4-Dipole Antenna
 - 2.2 77D Semi-Flexible Main Feeder
 - 2.3 CIN Diplexer
 - 2.4 Output Combining Equipment
 - 2.5 Test Load (20 KW)
3. STL and TSL
 - 3.1 Microwave Link
 - 3.2 4 m ϕ Parabolic Antenna
 - 3.3 VHF Telephone Equipment
 - 3.4 Remote Control Equipment
4. Measuring Equipment
5. Power Source Equipment
 - 5.1 Automatic Voltage Regulator
 - 5.2 Engine Generator
 - 5.3 Power Distribution Board

Table 9-2 MAIN FACILITIES OF
KOKAVIL TRANSMITTING STATION

1. VHF Television Transmitter (Parallel running)
 - 1.1 10 KW TV Transmitter 2 sets
 - 1.2 Transmitter Input Equipment
 - 1.3 Monitoring Equipment
 - 1.4 Control Console

2. TV Transmitting Antenna
 - 2.1 4-Dipole Antenna
 - 2.2 77D Semi-Flexible Main Feeder
 - 2.3 CIN Diplexer
 - 2.4 Output Combining Equipment
 - 2.5 Test Load (20 KW)

3. Microwave Link
 - 3.1 Microwave Link
 - 3.2 4 m ϕ Parabolic Antenna

4. Measuring Equipment

5. Power Source Equipment
 - 5.1 Automatic Voltage Regulator
 - 5.2 Engine Generator
 - 5.3 Power Distribution Board

Table 9-3 MAIN FACILITIES OF KANDY
TRANSMITTING STATION

1. VHF Television Translator (Standby System)
 - 1.1 50 W TV Translator 2 sets
 - 1.2 Accessories
2. TV Transmitting Antenna
 - 2.1 2-Dipole Antenna
 - 2.2 CF-10D Coaxial Feeder
 - 2.3 Coaxial Switching Equipment
 - 2.4 Test Load (50 W)
3. Receiving Antenna
 - 3.1 12-Element YAGI Antenna
 - 3.2 10D-2E Coaxial Feeder
4. Monitoring Equipment
 - 4.1 Monitoring Equipment by Telephone Line
 - 4.2 Air-Monitor Equipment
5. Measuring Equipment
6. Power Source Equipment
 - 6.1 Automatic Voltage Regulator
 - 6.2 Engine Generator
 - 6.3 Power Distribution Panel

Table 10 MAIN FACILITIES of MADUKANDA
Repeater Station

1. SHF, FM Transmitter (Standby System)
 - 1.1 SHF, FM Transmitter 2 sets
 - 1.2 Accessories
2. Terminal Equipment for P & T Line
3. Rebroadcasting Link
 - 3.1 VHF Receiver
 - 3.2 12-Element YAGI Antenna
 - 3.3 Accessories
4. Transmitting Antenna
 - 4.1 4 m ϕ Parabolic Antenna
5. Measuring and Monitoring Equipment
6. Power Source Equipment
 - 6.1 Automatic Voltage REGulator
 - 6.2 Engine Generator
 - 6.3 Power Distribution Panel

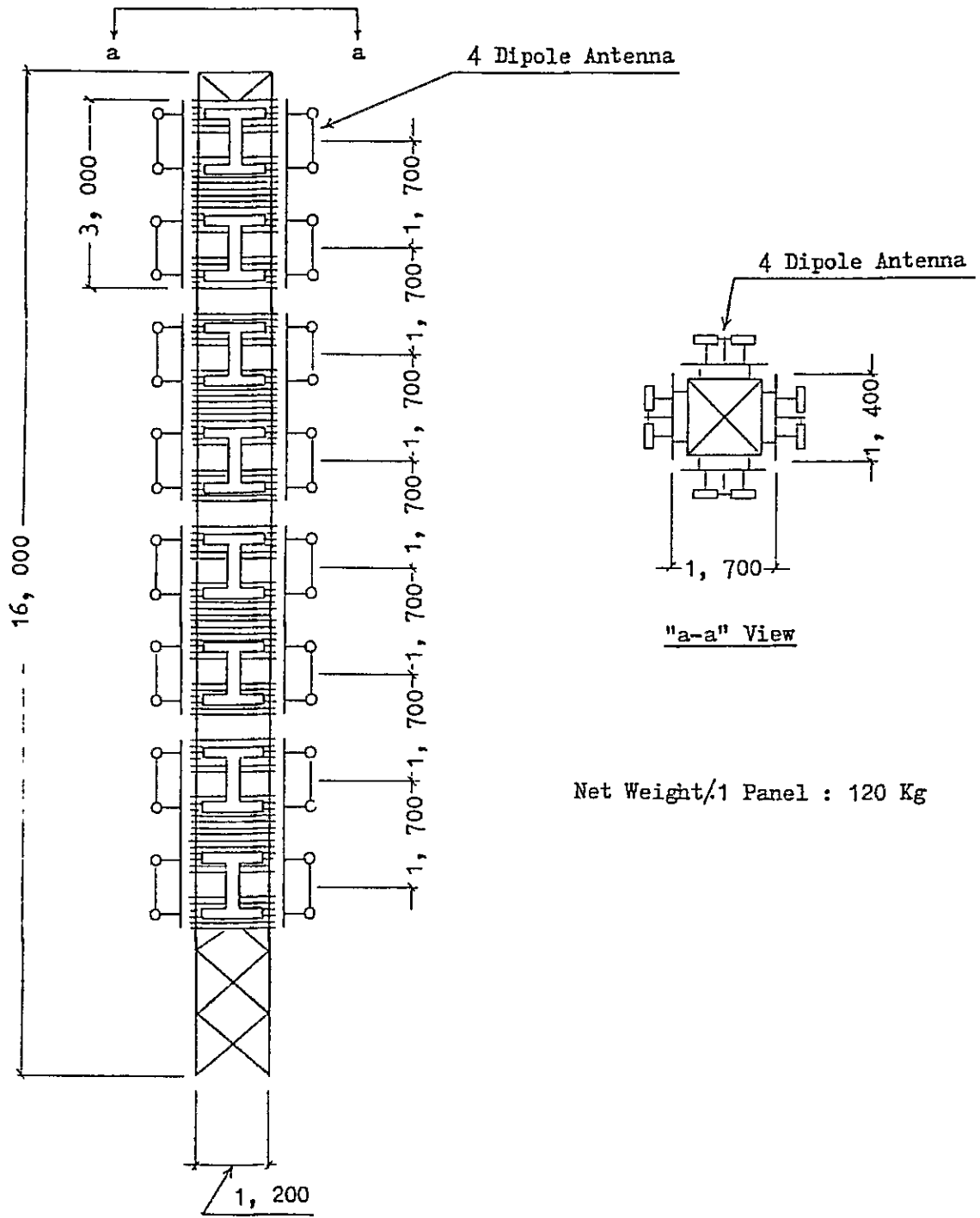

Unit : mm

Fig10-1 CONFIGURATION OF TRANSMITTING ANTENNA
FOR Mt. PIDURUTALAGALA STATION

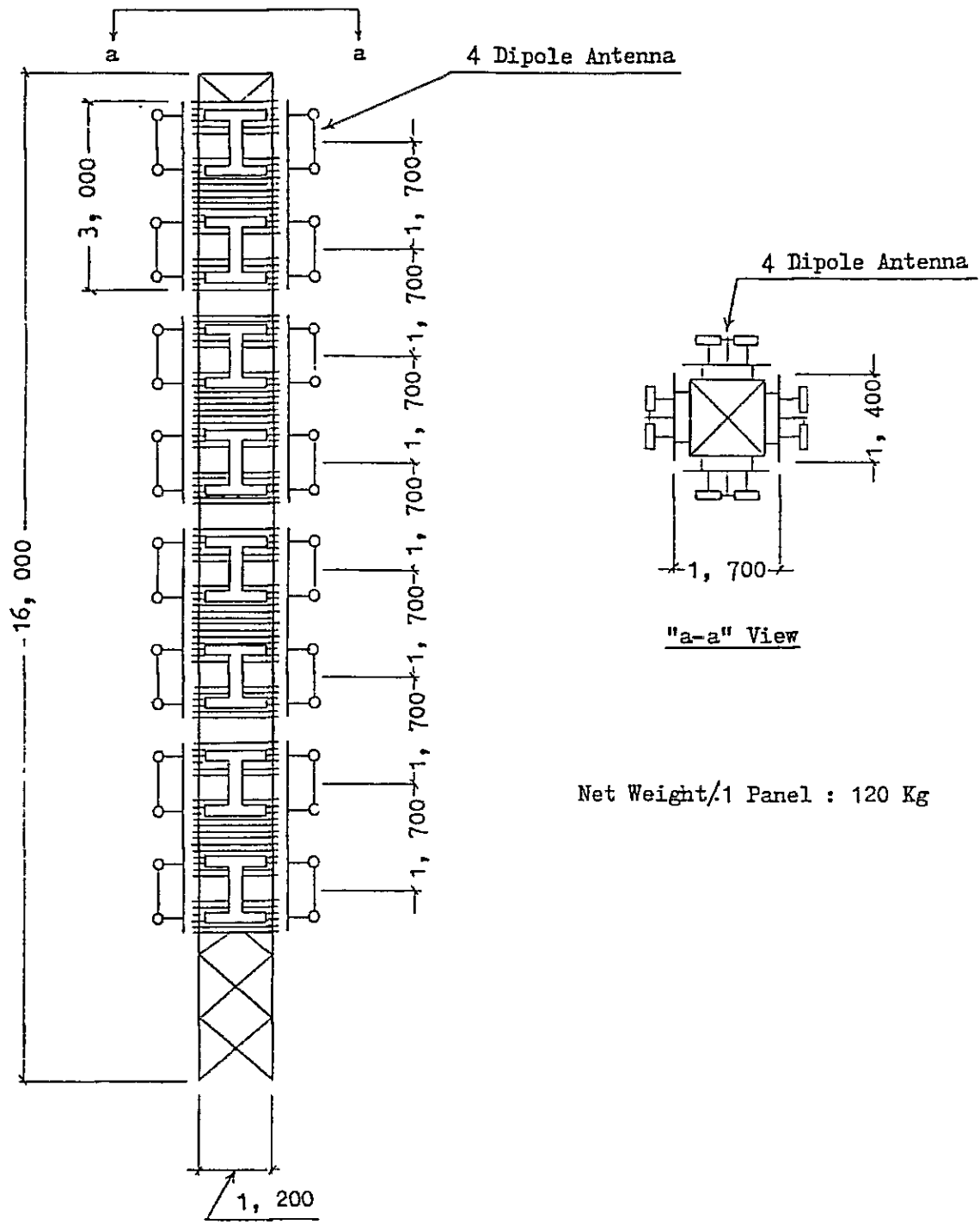

Net Weight/1 Panel : 120 Kg

Unit : mm

Fig10-2 CONFIGURATION OF TRANSMITTING ANTENNA FOR KOKAVIL STATION

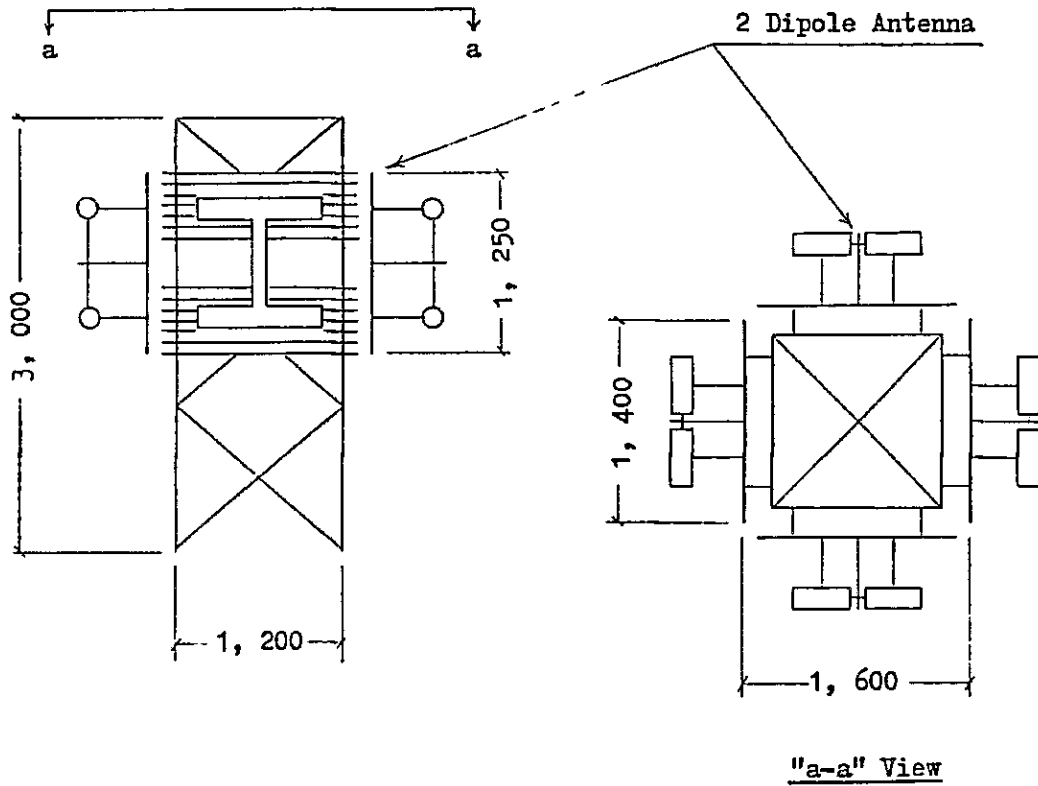

Net Weight/1 Panel : 60 Kg

Unit : mm

Fig10-3 CONFIGURATION OF TRANSMITTING ANTENNA
FOR KANDY STATION

COLOMBO STUDIO

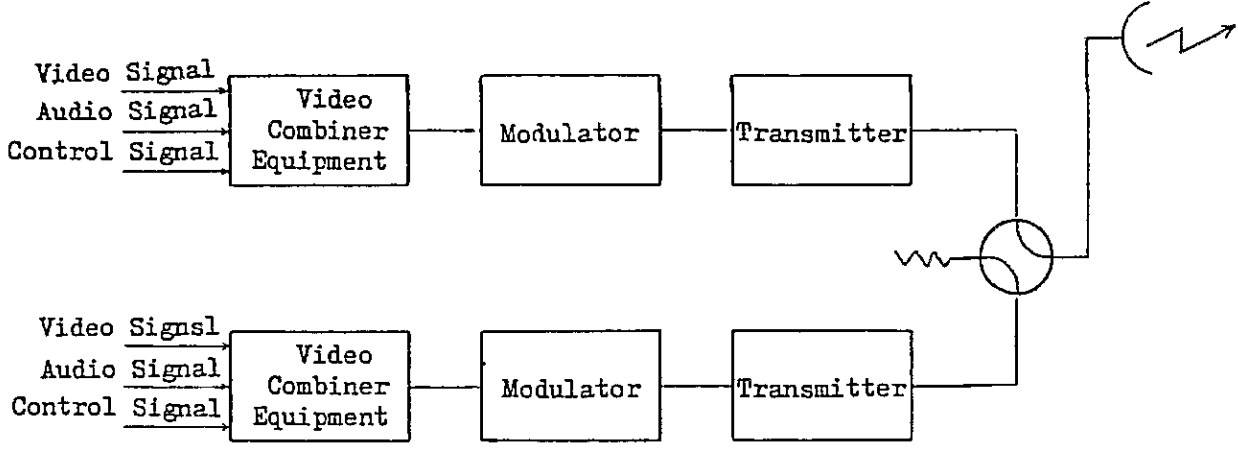

Mt. PIDURUTALAGALA
TRANSMITTING STATION

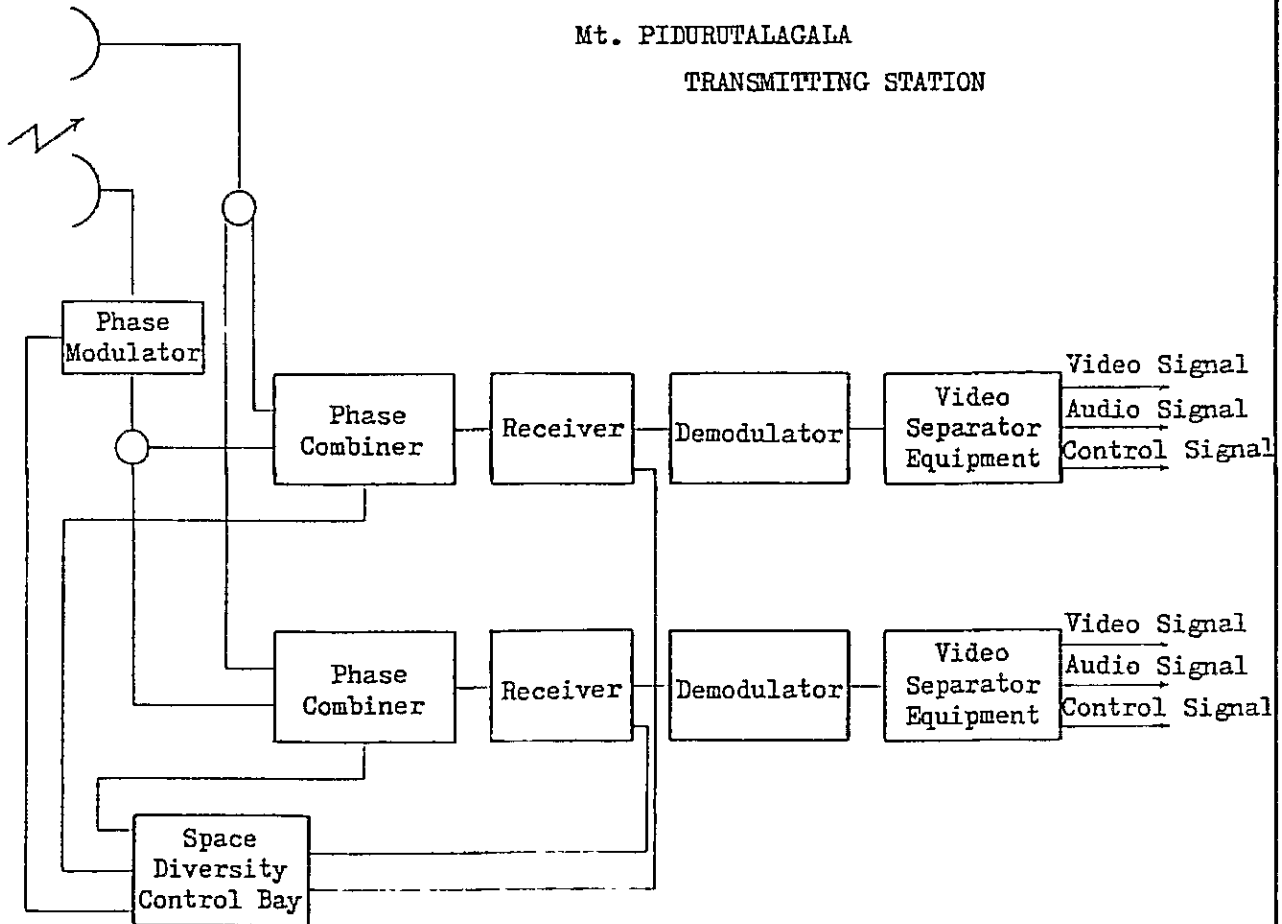

Fig1-1 SCHEMATIC DIAGRAM OF MICROWAVE LINK
(FROM COLOMBO TO Mt. PIDURUTALAGALA)

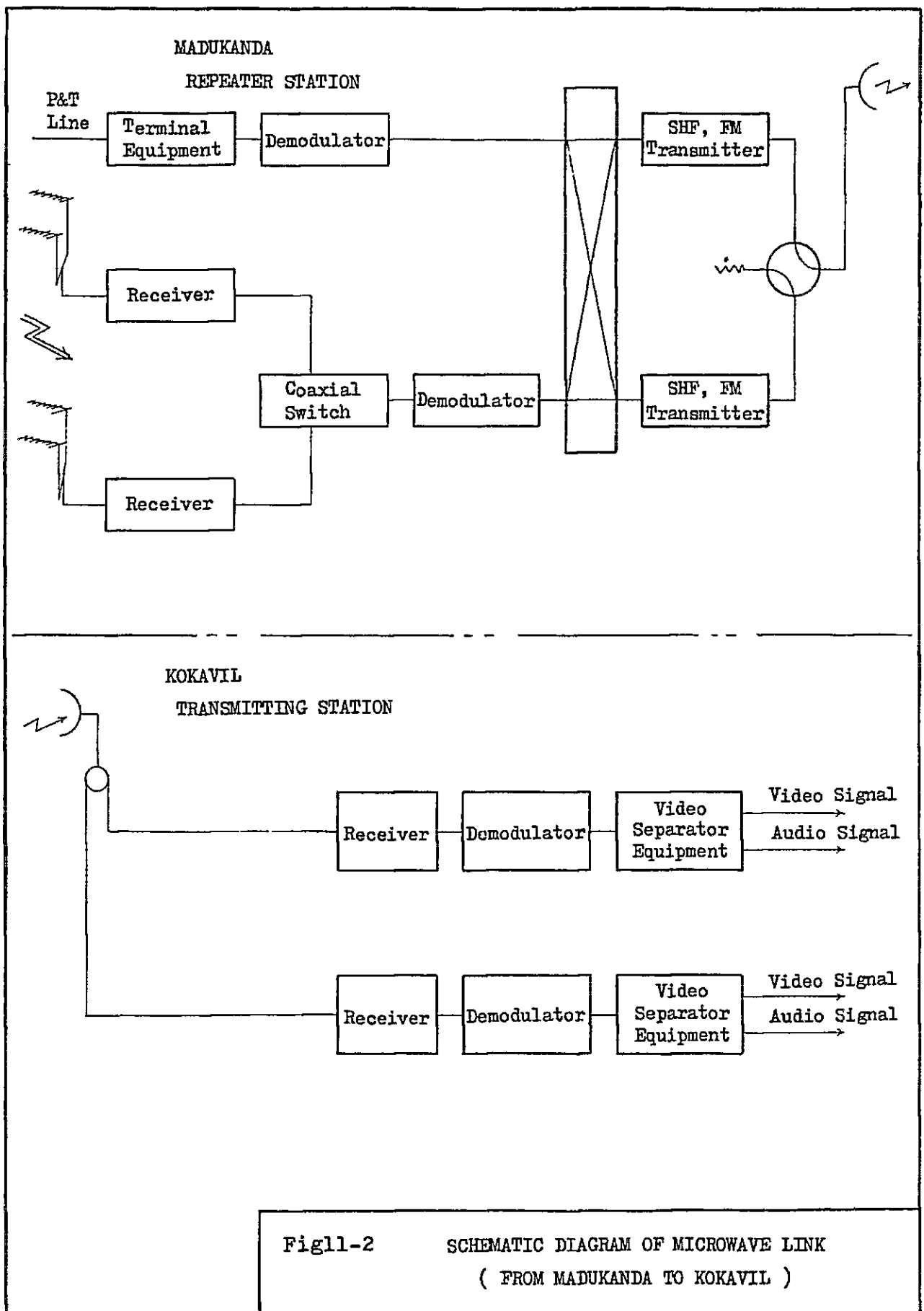
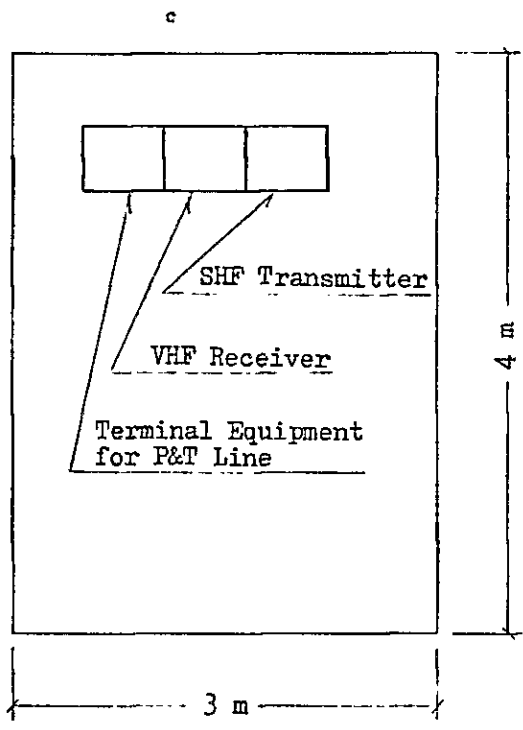

Fig11-2 SCHEMATIC DIAGRAM OF MICROWAVE LINK
(FROM MADUKANDA TO KOKAVIL)



Scale : 1/50

Fig12 FLOOR LAYOUT OF TRANSMITTING ROOM
FOR MADUKANDA STATION

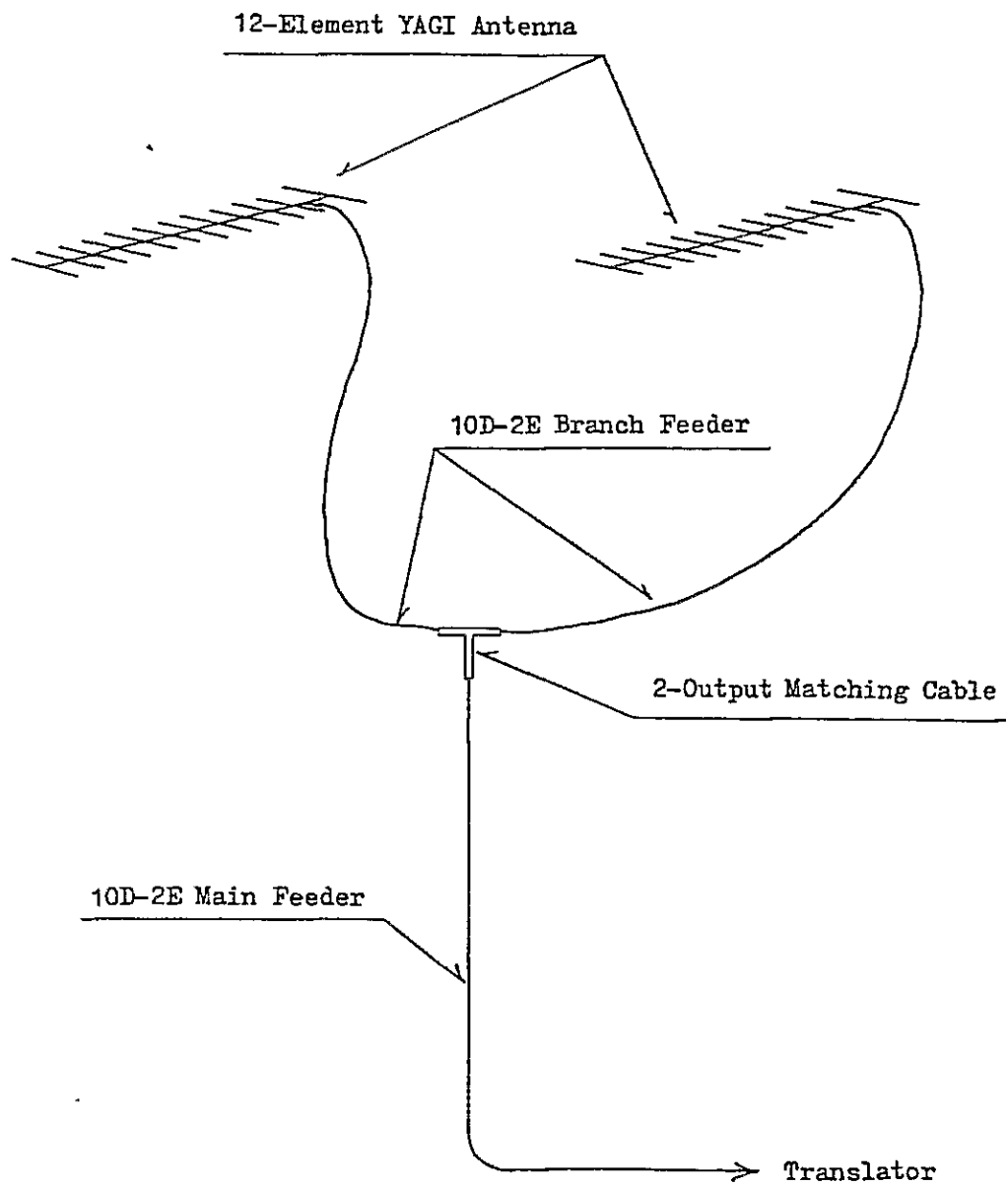

Fig13
Schematic Diagram of Recieving Antenna
System for Kandy Station

TV STUDIO BUILDING

EXISTING FENCE LINE

PROPOSED BORDER LINE

FOOD STUFFS BUILDING EQUIPMENT

SCENERY PROPERTIES

EXTENSION SPACE

HOCKEY CLUB

EXISTING TRANSFORM STATION

ROAD

ROAD

ROAD

COURT

OFFICE BLOCK

ENTRANCE

GREEN

GREEN

GREEN

GREEN

GREEN

TOWER

STUDIO BLOCK

CANOPY

GREEN

GREEN

GREEN

GREEN

GREEN

PARKING AREA

GREEN

GREEN

GREEN

GREEN

GREEN

GREEN

GREEN

EXISTING S.I.B.C. BUILDING

EXISTING S.I.B.C. BUILDING

EXISTING S.I.B.C. BUILDING

EXISTING S.I.B.C. BUILDING

EXISTING S.I.B.C. BUILDING

EXISTING S.I.B.C. BUILDING

EXISTING S.I.B.C. BUILDING

EXISTING S.I.B.C. BUILDING

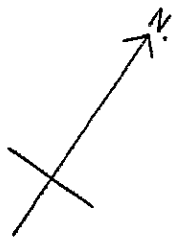

FIG.14-1 PLOT PLAN

S = 1/192

IV. STUDIO BUILDING

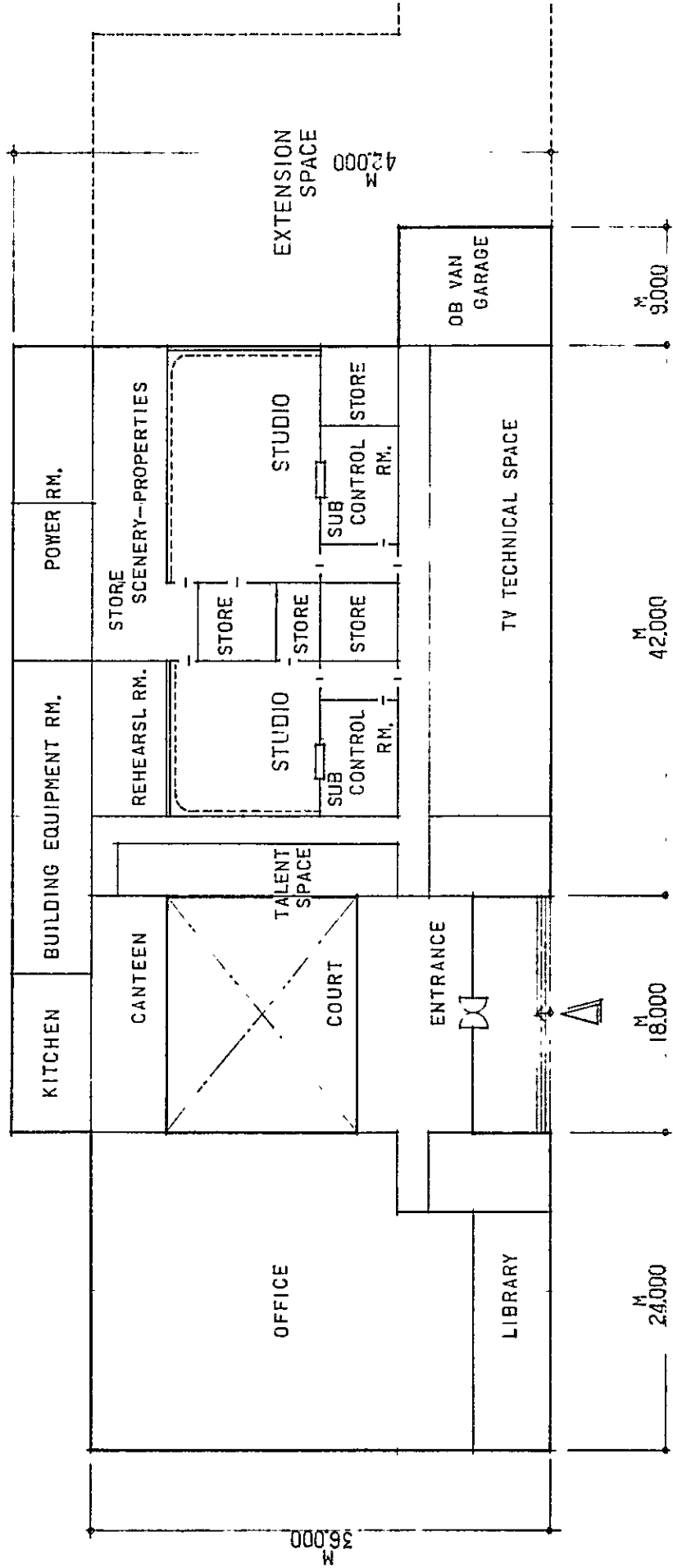
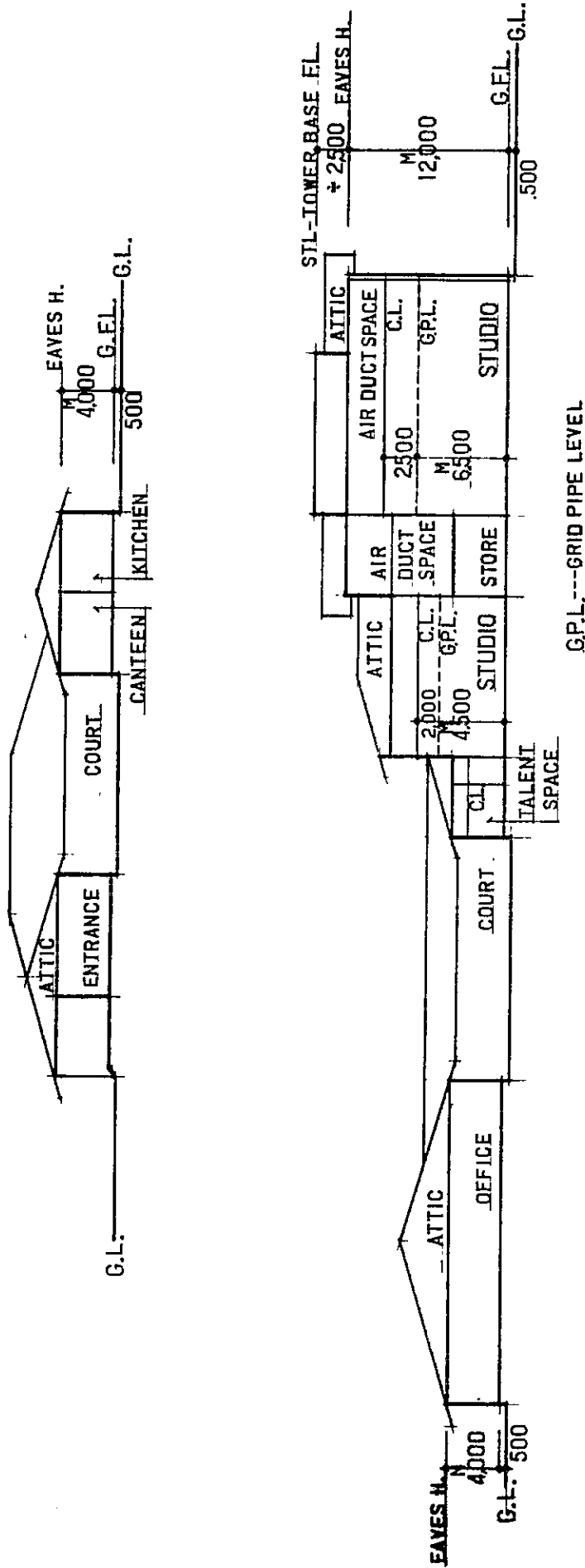

FIG.14-2 FLOOR PLAN

S = 1/300

TV STUDIO BUILDING



E18.14-3 SECTION

S - 1/300

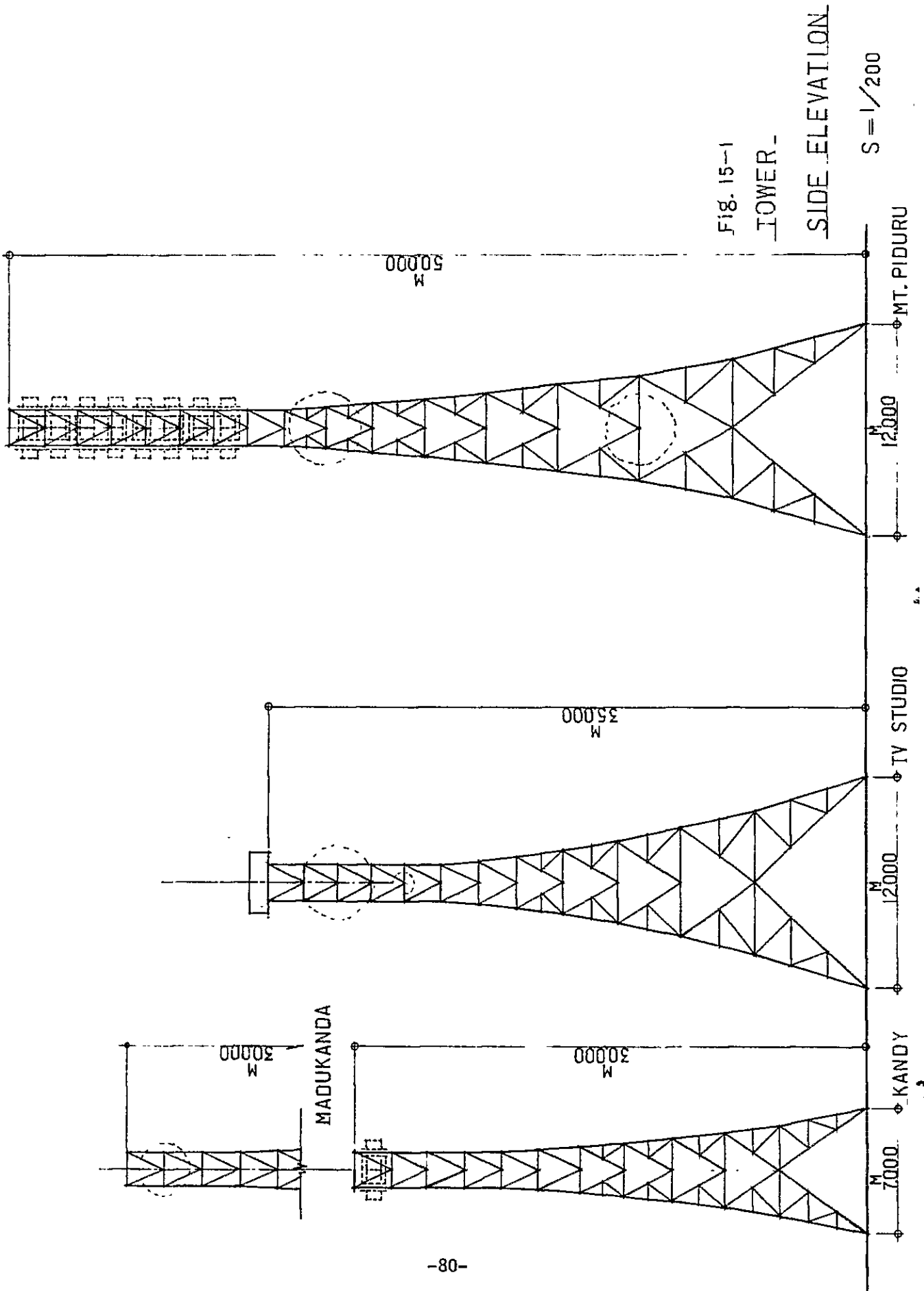

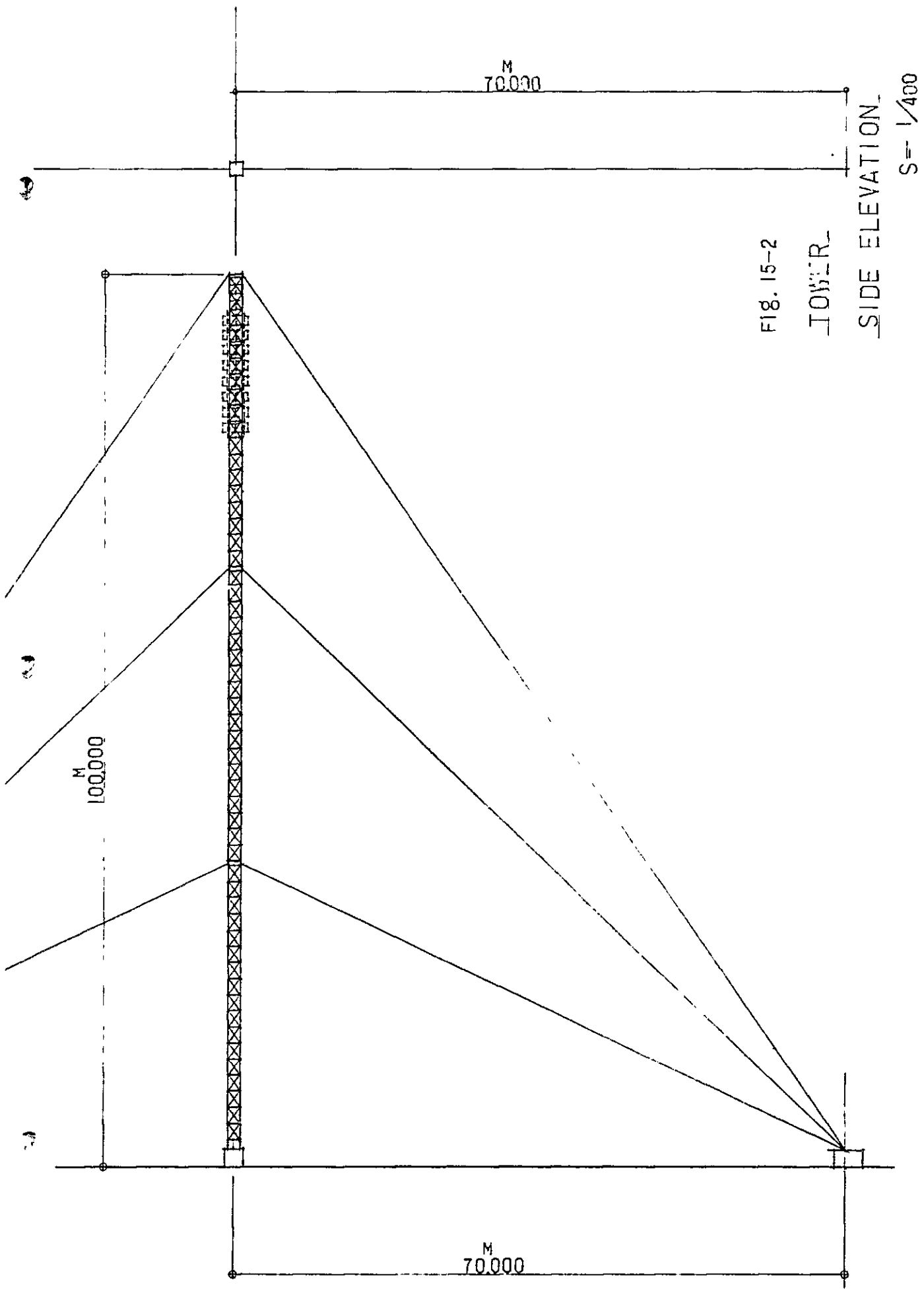
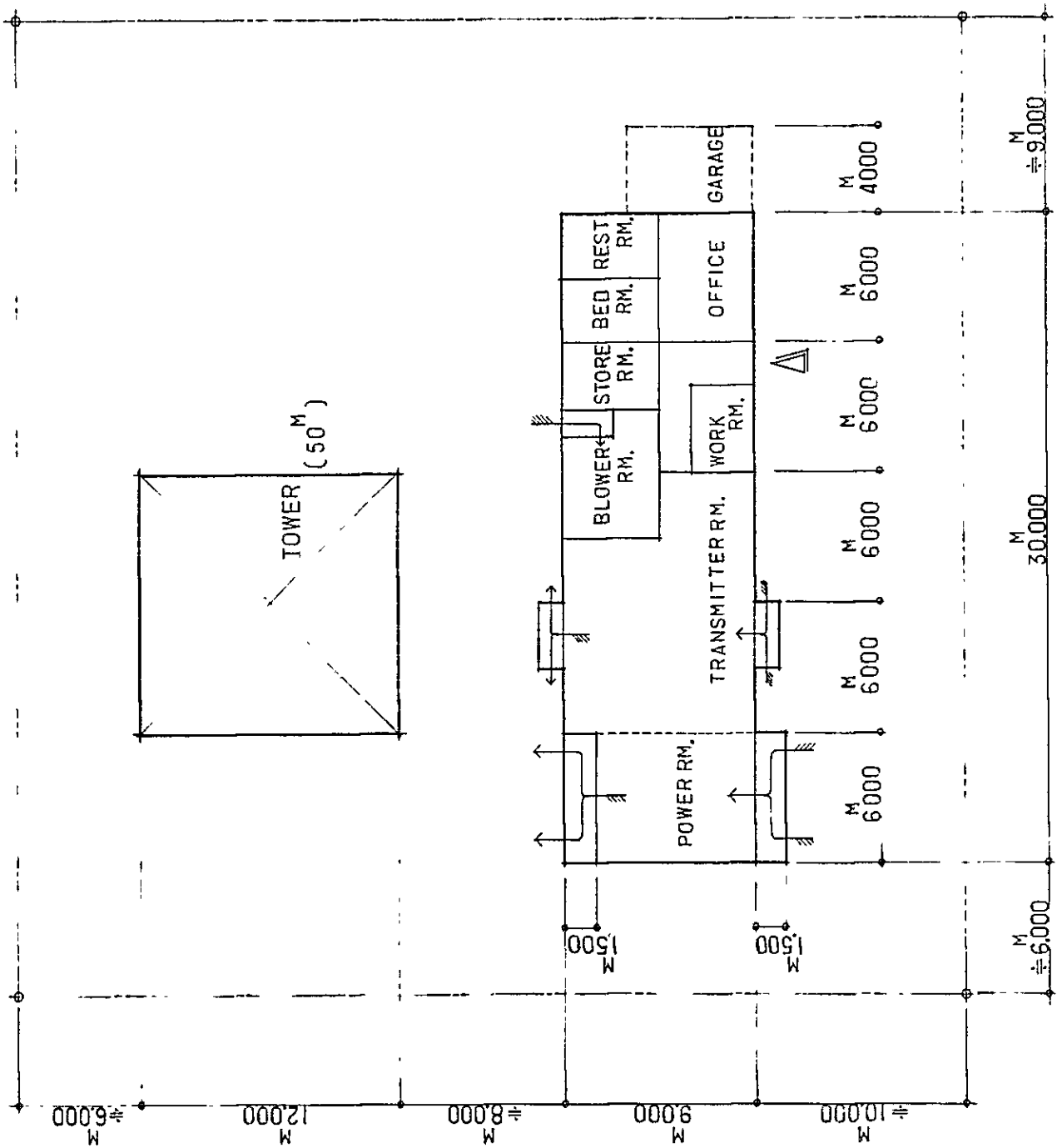

FIG. 15-2
TOWER

SIDE ELEVATION
S = 1/400

M
70,000

M
100,000



TRANSMITTING STATION
(MT. PIDURUTALAGALA)

FIG. 16 PLOT AND
FLOOR PLAN

S = 1/200

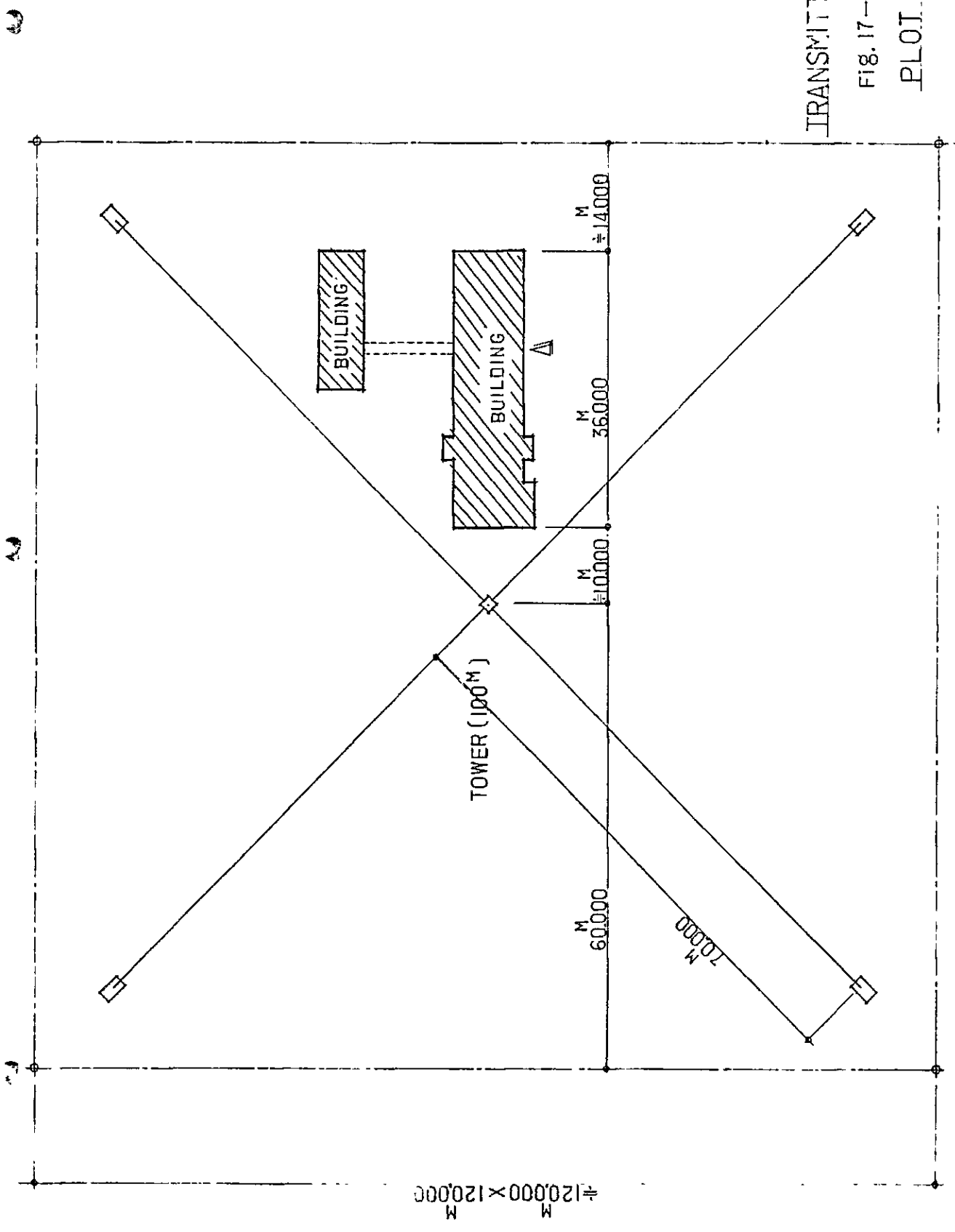

TRANSMITTING STATION
[KOKAVIL]

FIG. 17-1

PLOT PLAN

S = 1/500

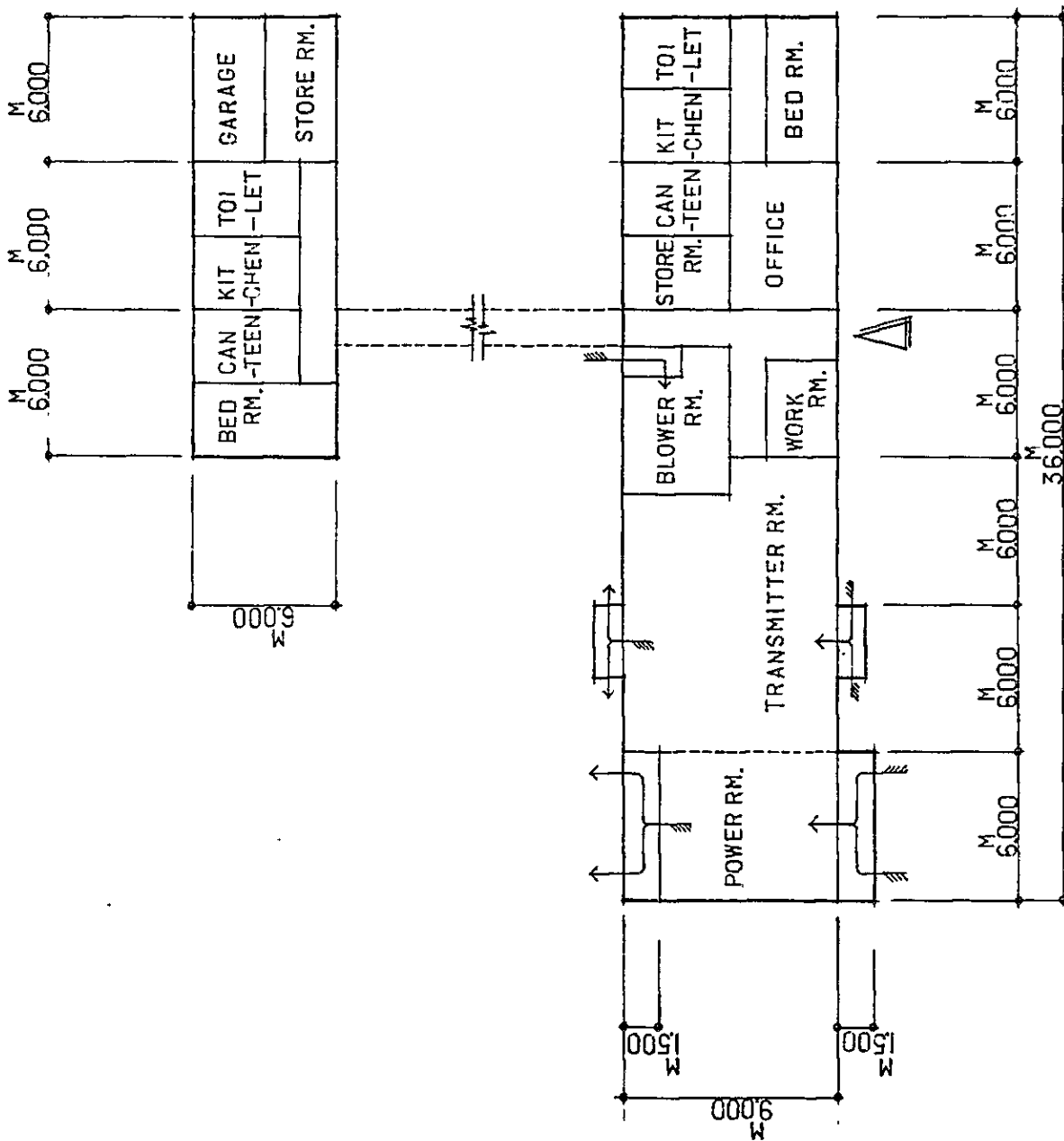

TRANSMITTING STATION
(KOKAVIL)

Fig. 17-2 FLOOR PLAN

S = 1/200

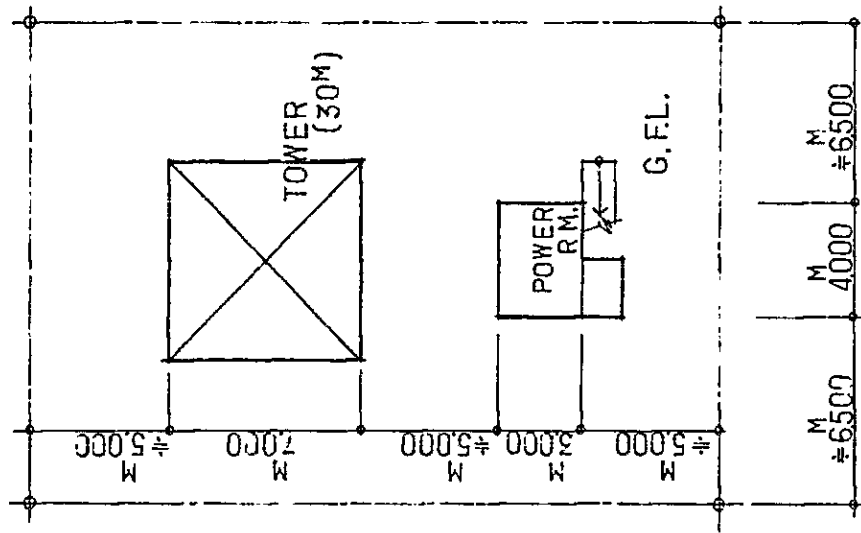
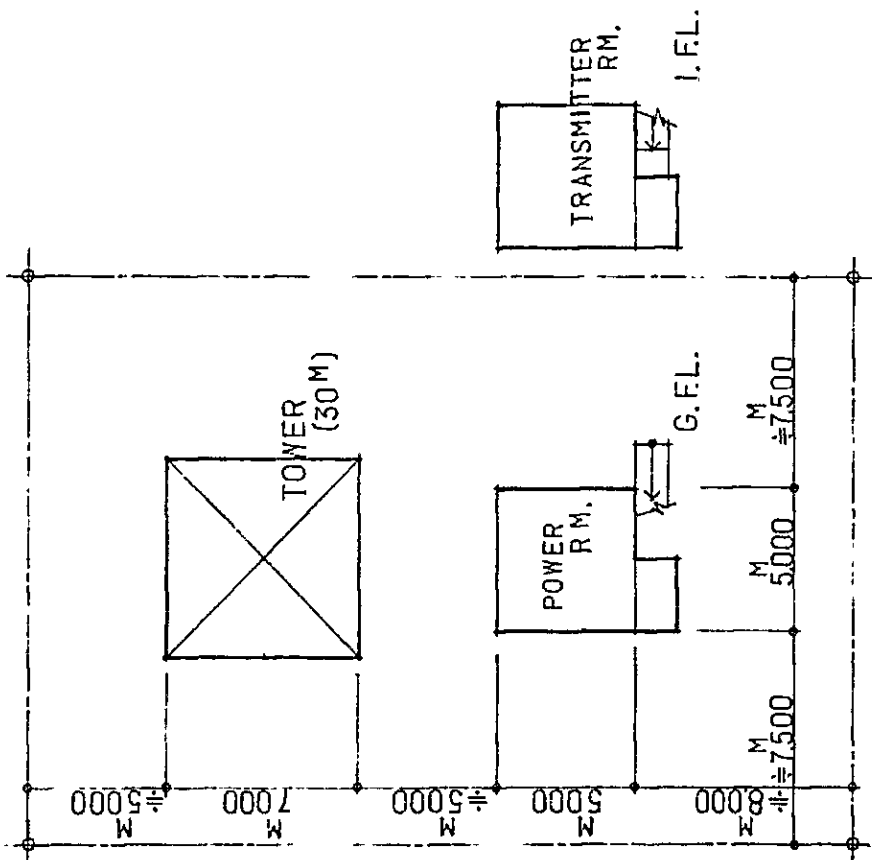

Fig. 18

RELAY STATION
(MADUKANDA)

FLOOR PLAN

S = 1/200



TRANSMITTING STATION
(KANDY)

SECTION 3 IMPLEMENTATION PLAN

3-1 Construction Schedule

In planning the construction schedule of the nationwide television broadcasting network, the following items were considered.

- (1) The entire construction work should be finished within 21 months.
- (2) For the purpose of saving manpower, the construction work for each station should be arranged so that there will be no duplication. Equipment installation should be accomplished in the following order of stations.
 - 1) Kokavil Transmitting Station
 - 2) Madukanda Relay Station
 - 3) Kandy Transmitting Station
 - 4) Mt. Pidurutalagala Transmitting Station and Colombo Studio

Although it is desirable to progress equipment installation in the order of off-air relay, the equipment installation at Mt. Pidurutalagala Transmitting Station will be required to come at the end of the entire construction schedule, after completion of access roads and succeeding station building construction and so the equipment installation is planned to be started with Kokavil Transmitting Station. The overall adjustment of the respective transmitting stations by off-air is planned to be conducted as a "final test" during the last month of the construction schedule. The construction schedule is shown in Table 11.

The construction schedule is prepared on the following premises.

- 1) The construction schedule is tabulated for the total number of months from the start.
- 2) For proper control of the construction process, detailed part/time schedule should be made on the basis of the construction process.
- 3) For the construction of Mt. Pidurutalagala Transmitting Station, interruption of construction which may be caused by rainy seasons is not considered. Work necessary for ground leveling should be started prior to the completion of the access road for contraction of the construction period.
- 4) The terms of works assigned in the construction schedule are as follows:
 - a) Equipment manufacture (excluding preparation): 10 months
 - b) Manufacture of steel tower/mast and aerial
(excluding preparation): 6 months
 - c) Ground leveling: 1 ~ 3 months
 - d) Transmitting station building construction
Mt. Pidurutalagala: 7 months

Table 11 Construction Schedule

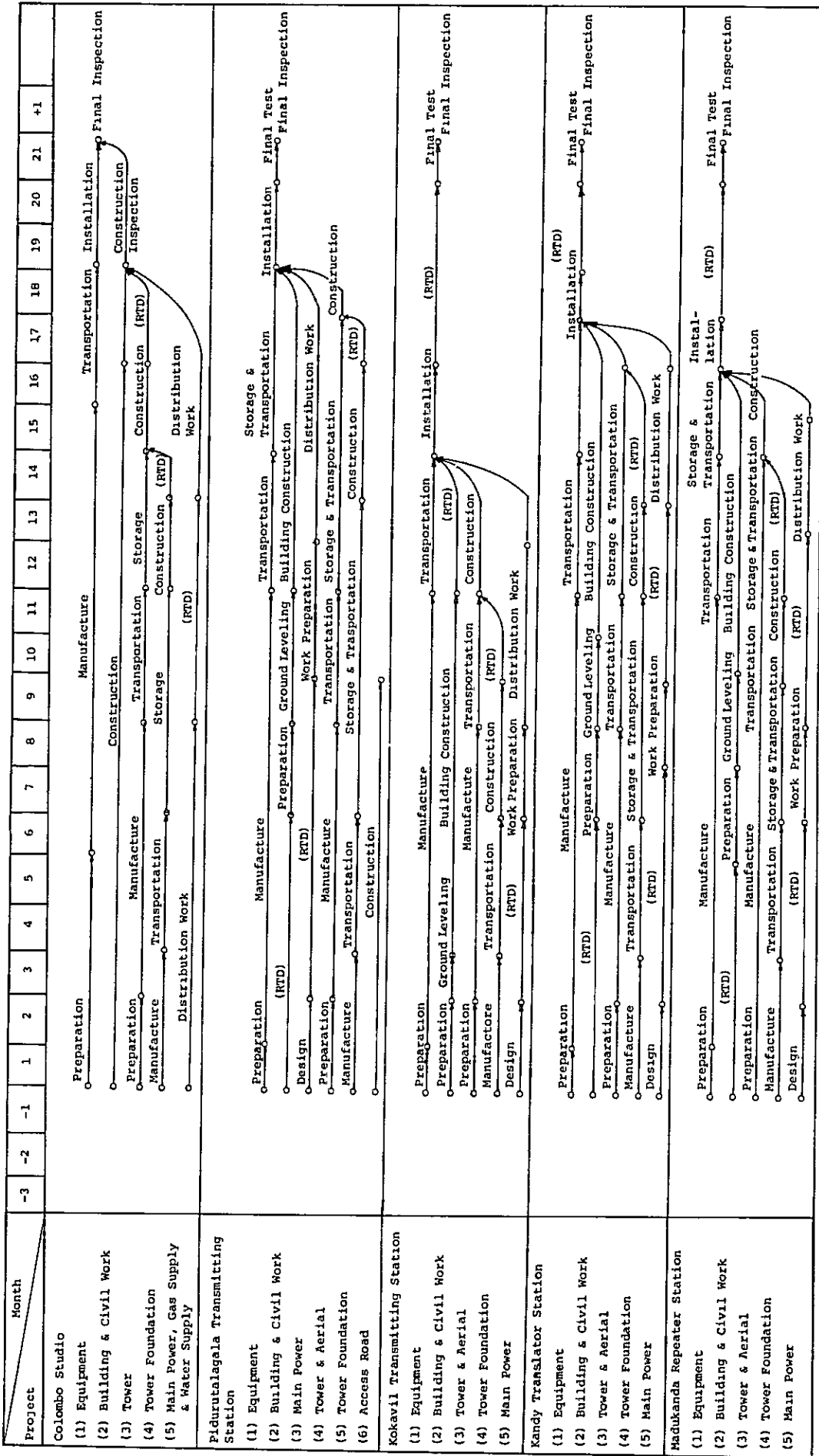

Legend

- Circle (o): Event (Time when managerial judgement is required.)
- Solid line (-): Activity (Work which requires time or resource)
- Solid line (RTD): Real time dummy (Dependency which requires time but no work)

Kokavil: 8 months

Kandy: 7 months

e) Building construction at Madukanda

Relay Station: 7 months

f) Building construction at Colombo Studio: 21 months

5) Equipment installation at the studio will be completed within 3 months after the interim building inspection.

6) Equipment installation at the respective transmitting stations and relay stations will be completed by the following periods after the final building inspection is over. Construction work of steel tower/mast and aerial will be completed before equipment installation.

Name of Transmitting Station and Relay Station	Equipment Installation	Tower/Mast and Aerial Construction
Mt. Pidurutalagala Transmitting Station	2 months	2 months
Kokavil Transmitting Station	2 months	3 months
Kandy Transmitting Station	1 month	1.5 months
Madukanda relay Station	1 month	1.5 months

7) After completion of the foundation, construction of steel tower/mast will be started.

8) In implementing the construction work of the television broadcasting network, particular care should be taken in selection of broadcasting facility consultant and architectural consultant. They should have profound experience in the construction of broadcasting stations and their personnel should also have the ample experience. For smooth progress of construction work, close contact should be made between the broadcasting facilities consultant and architectural consultant and it is recommendable to select such a consultant that will cover both fields of work. The variety of broadcasting facilitates goes over a wide range and the construction schedule affords no ample margin, so that it is extremely difficult to progress the construction work as expected without profound experience. In addition, the studio building has a specific construction as a building and its architectural work and the consulting should be performed in detail and with profound experience for allowing smooth programme production.

3-2 Construction Budget

The total construction budget necessary for the implementation of this project (excluding expenses for incidental works) is 3,500 million yens (276 million ruppees). The breakdown of the budget is given in Table 12. The estimation of the expenses is made on the following conditions in preparing the budget.

- 1) Estimation is made as of August 1978.
- 2) All equipment and materials for the construction are estimated on the condition of CIF Colombo.
- 3) Economic change if caused during the period of construction will be compensated for by part of the contingency.
- 4) Foreign exchange rates are as follows:
 - US \$1 = ¥190
 - US \$1 = Rs. 15
 - Rs. 1 = ¥12.7

The breakdown of the total construction budget into respective items is given below.

- 1) Expense for Equipment
 - 1,422 million yen (112 million rupees)
- 2) Expense for installation
 - 242 million yen (19 million rupees)
- 3) Expenses for station buildings and steel towers/mast
 - 1,417 million yen (112 million rupees)
- 4) Consultant fee
 - 126 million yen (10 million rupees)
- 5) Contingency
 - 293 million yen (23 million rupees)

In addition to these expenses, the expense for inland transportation and expense for work incidental to building construction will be required, as follows.

- 1) Expense for inland transportation
 - Since the expense for the equipment and materials is estimated on the condition of CIF Colombo, it is necessary to estimate 12.1 million yen (0.9 million rupees) for inland transportation in Sri Lanka (including warehouse charges).
- 2) Expense for works incidental to building construction
 - Expenses for the civil work of sites and access roads, etc., provision of power line, water, etc., are given below for reference's sake.

Table 12 Construction Budget

Item	Expense for Equipment	Expense for Installation	Expense for Buildings and Steel Tower/Mast	Thousand Yen (Thousand Rs)
Colombo Studio	950,184 (74,818)	85,975 (6,770)	874,600 (68,866)	1,910,759 (150,454)
Pidurutalala Transmitting Station	220,418 (17,356)	78,785 (6,204)	196,200 (15,449)	495,403 (39,009)
Kokavil Transmitting Station	172,388 (13,574)	60,465 (4,761)	257,000 (20,236)	489,853 (38,571)
Kandy Transmitting Station	36,115 (2,844)	13,691 (1,078)	49,000 (3,858)	98,806 (7,780)
Madukanda Repeater Station	43,091 (3,393)	3,190 (251)	40,300 (3,173)	86,581 (, 817)
Total	1,422,196 (111,985)	242,106 (19,064)	1,417,100 (111,532)	3,081,402 (242,631)
Consultant Fee			125,742 (9,901)	
Total			3,207,144 (252,532)	
Contingency			292,856 (23,060)	
Grand Total			3,500,000 (275,592)	

References

(1) Colombo Studio

Waterworks	Th. Rs. 5	(Th.₹ = 63.5)
Drainage works	Th. Rs. 5	(Th.₹ = 63.5)
Gas fitting works	Th. Rs. 7.5	(Ths.₹ =95.3)
Total	Th. Rs.17.5	(Th.₹ =222.3)

(2) Power Line

Station	Length (km)	Expense Th.Rs. (Th.₹)	Remarks
Colombo Studio	1	50 (635)	To branch from power line to SLBC.
Pidurutalagala Transmitting Station	3	150 (1,905)	To construct 33KV power line from Nuwara Eliya
Kokavil Transmitting Station	14.4	720 (9,144)	To construct 33 kV power line from Kilinochchi Grid Substation.
Kandy Transmitting Station	0	0	To branch from power line to Primrose Hill Microwave Station.
Madukanda Relay Station	0	0	To branch from power line to Madukanda Microwave Station
Total		920 (11,684)	

Power Line Construction Expense (per km)

33KV.....Th. Rs.50
 11KV.....Th. Rs.45
 Low voltage...Th. Rs.40

(3) Expenses for Electric Main Facilities and Installation

Name of Station	Installed Capacity (KVA)	Facilities Th. Rs (Th.₹)	Installation Th.Rs (Th.₹)	Total Th.Rs (Th.₹)
Colombo Studio	300	1,980 (25,146)	594 (7,544)	2,574 (32,690)
Pidurutalagala Transmitting Station	200	630 (8,001)	202 (2,565)	832 (10,566)
Kokavil Transmitting Station	200	720 (9,144)	238 (3,023)	958 (12,167)
Kandy Transmitting Station	30	360 (4,572)	126 (1,600)	486 (6,172)
Madukanda Relay Station	10	129 (1,638)	46 (584)	175 (2,222)
Total		3,819 (48,501)	1,206 (15,316)	5,025 (63,817)

(4) Expenses for Civil Work

Name of Station	Item	Th.Rs (Th.₹)
Colombo Studio	Leveling of Site (12,000 m ²)	462 (5,867)
Pidurutalagala Transmitting Station	Leveling of Site (2,000 m ²)	1,846 (23,444)
Pidurutalagala Transmitting Station	Access road (10 km)	9,231 (117,234)
Kandy Transmitting Station	Leveling of Site (600 m ²)	19 (241)
Kandy Transmitting Station	Access road (1 km)	112 (1,422)
Madukanda Relay Station	Leveling of Site (400 m ²)	23 (292)
Total		11,693 (148,500)

3-3 Maintenance and Operating Expense

Table 13 gives the maintenance and operating expense of the nationwide television broadcasting network which was estimated on the following condition.

- 1) Expenses necessary for five (5) years after starting service are estimated on the condition of opening all stations at a time.

- 2) The equipment maintenance expense is an expense for the replacement of pick-up tubes and transmitting tubes, repair of failed equipment, inspection of steel towers/mast, replenishment of consumable parts, etc. The equipment maintenance expense is estimated to be equal to 0.5% of the total equipment expense.
- 3) The film programme expense is estimated for the purchase of two (2) film programmes per month.
- 4) The electric charge is estimated on the condition of operating Colombo Studio for five (5) hours a day and each transmitting and the relay station for three (3) hours a day.
- 5) The expense for fuel for engine generators for emergency use is estimated on the assumption of operating each station for six (6) hours a month.
- 6) Personnel expense is not estimated since SLBC personnel is expected to work concurrently.

Table 13 Maintenance and Operating Expense

Item	Th. Rs (Th. ₹)				
	1	2	3	4	5
1. Equipment Maintenance	533 (6,769)	565 (7,176)	599 (7,607)	635 (8,064)	673 (8,547)
2. Film Programme	540 (6,858)	573 (7,277)	607 (7,709)	643 (8,166)	692 (8,788)
3. Electric Charge	9,704 (123,241)	10,286 (130,632)	10,903 (138,468)	11,557 (146,787)	12,251 (155,588)
4. Expense for Engine Generator Fuel	5 (64)	5 (64)	6 (76)	6 (76)	6 (76)
5. Miscellaneous	1,078 (13,691)	1,143 (14,516)	1,212 (15,392)	1,284 (16,307)	1,361 (17,285)
Total	11,860 (150,623)	12,572 (159,665)	13,327 (169,252)	14,127 (179,400)	14,983 (190,284)

SECTION 4 OPERATION PLAN

4-1 Organization and Management

It is necessary, before everything, to determine the management form of the television broadcast enterpriser. Two different forms of broadcast enterpriser (broadcaster) can be considered: public and private. Which of these forms should be adopted is determined by the purposes of the television broadcasting service and the expected reveue/expenditure of the broadcast enterpriser.

Let us first consider the purposes of the television broadcasting service. The nationwide television broadcasting to be established in Sri Lanka has the following three (3) purposes.

- 1) Equalization in level of people and provision of equal opportunity to all people
- 2) Economical development through spread and development of techniques in agriculture, fishing, small-scale industries, etc.
- 3) Development in education

These purposes are among policies of the country. In order to achieve these purposes operation by a public broadcast enterpriser will be suitable. Now, let us discuss from the expected revenue/expenditure of the broadcast enterpriser. A private operator must be managed mostly by the income from commercials. At present, the Sri Lanka Broadcasting Corporation (hereinafter referred to as SLBC) is presenting radio broadcasting service, and broadcasting hours of commercials amount to 192 hours a week. According to the SLBC's revenue/expenditure table given below, the expected income from commercials is 9,400 thousand Rs. in 1978 or 942 Rs. $(9,400 \text{ Th Rs} \times \frac{1}{192 \text{ hours} \times 52 \text{ weeks}})$ per hour. In Japan, a TV commercial for a given period of time is about 6 times as expensive as radio commercial for the same period of time. If this rate is applicable in Sri Lanka, the TV commercial rate in Sri Lanka will be 5,652 Rs per hour. Accordingly, when the broadcasting is performed three (3) hours per day by a private broadcast enterpriser, it can be estimated that the following maximum annual income can be expected.

$$5,652 \text{ Rs} \times 3 \text{ hours} \times 365 \text{ days} \doteq 6,189 \text{ Th Rs.}$$

In Japan, the operating expense of a television broadcast enterpriser is about eight (8) times as large as that of a radio broadcaster of the same scale. If this ratio is applicable in Sri Lanka, the operating expense of SLBC can be estimated on the basis of the SLBC's expenditure of 1978 under the condition that the broadcasting hours of LSBC are 85 hours in total including international broadcasting and the operating expense is proportional to the broadcast hours.

$$27,614 \text{ Th.Rs.} \times 8 \times \frac{3 \text{ hours}}{85 \text{ hours}} = 7,797 \text{ Th.Rs.}$$

If the addition of capital expenditure is also considered, it can be estimated that it is rather difficult to manage and operate the television broadcast enterpriser by commercial fees only.

To summarise, it is desirable that the television broadcast enterpriser in Sri Lanka should be public and not private. Now, suppose the broadcast is a public operator which is better --- to construct a new organization or expand the existing SLBC so as to be able to incorporate the television broadcaster as well? Since it is rather difficult to train and produce broadcasting engineers newly and some of the existing SLBC facilities are usable for television broadcasting also, also, it is desirable to expand the existing SLBC so as to be able to present both radio and television broadcasting.

The incoming sources of the expanded SLBC will be television receiving charge, television commercial fees, radio receiving charge, radio commercial fees, and government subsidy.

A proper television receiving charge should be determined in consideration of SLBC's revenue/expenditure.

Revenue/Expenditure of Sri Lanka Broadcasting Corporation

(Unit: Thousand Rs.)

FY Item	1974	1975	1976	1977 (Expected)	1978 (Budget)
Revenue	16,204	18,970	19,617	21,269	23,614
Receiving Charge	8,250	8,525	8,870	8,750	9,500
Commercial Fee	5,063	7,010	7,024	8,400	9,400
Expenditure	16,530	19,489	20,037	24,721	27,614
Personnel Expense	10,622	11,922	12,374	14,368	16,354
Surplus	-326	-519	-420	-3,452	-4,000

Note 1: The shortage of 4 million rupees of 1978 should be supplied from the Government subsidy.

Note 2: Capital incomes in capital balance: from Government subsidy

4-2 Popularization Plan

4-2-1 Estimation of Spread of TV Receivers

Now, let us estimate, by the following two methods, the rate of spread of TV receivers when television broadcasting is introduced in Sri Lanka.

(1) Estimation from correlation with GNP per person

The GNP's per person of 20 major countries in 1973 and the rate of spread

of TV receivers vs. population (%) are given in Table 14. The regression equation which indicates the correlation between GNP per person and the rate of spread of TV receivers vs. population can be obtained by the method of least squares and is as follows.

$$Y = 143.54 x + 97.99$$

x: Rate of spread of TV receiver vs. population (%)

y: GNP per person (US \$)

The regression curve obtained is shown in Fig. 19.

Now, let us estimate future GNP per person of Sri Lanka by the following method.

A. Estimation of population

The average increase of population for the past ten (10) years is 1.8%.

It is assumed that this tendency will not change.

B. GNP

The average annual GNP increase of the past ten (10) years is 13.7%.

It is assumed that this tendency will not change.

By thus estimating the future population, GNP, and GNP per person, the rate of spread of TV receivers and the total number of TV receivers can be given as shown in Table 15. Values for 1977 and 1978 are estimated on the assumption that TV broadcasting has been already introduced in these years.

(2) Estimation based on Rate of Spread of TV Receivers in Different Strata of Income in Japan

Table 16 gives estimated household constitution (1977) for different strata of income in Sri Lanka as obtained on the basis of data of 1973. (Estimation was made in consideration of the 1:2 GNP ratio of 1973 and 1977.)

By considering also the percentage of households having TV receivers for different strata of income in Japan, the percentage of households capable of possessing TV receivers in 1977 was estimated and given in Table 17. According to this estimation, 5.18 households out of 100 households appeared to be capable of possessing TV receivers. Suppose the number of household members per household in Sri Lanka is 5.18, the rate of spread of TV receivers vs. population becomes 1%, meeting the estimation of item (1) above. Actually, the number of household members per household is 5.33 as of 1971. In consideration of the recent tendency of increase of smaller households by adoption of the family plan and others, the figure of 5.18 may not be so far from the actual situation.

Fig19 Regression Line for GNP Per Person and Rate of Spread of

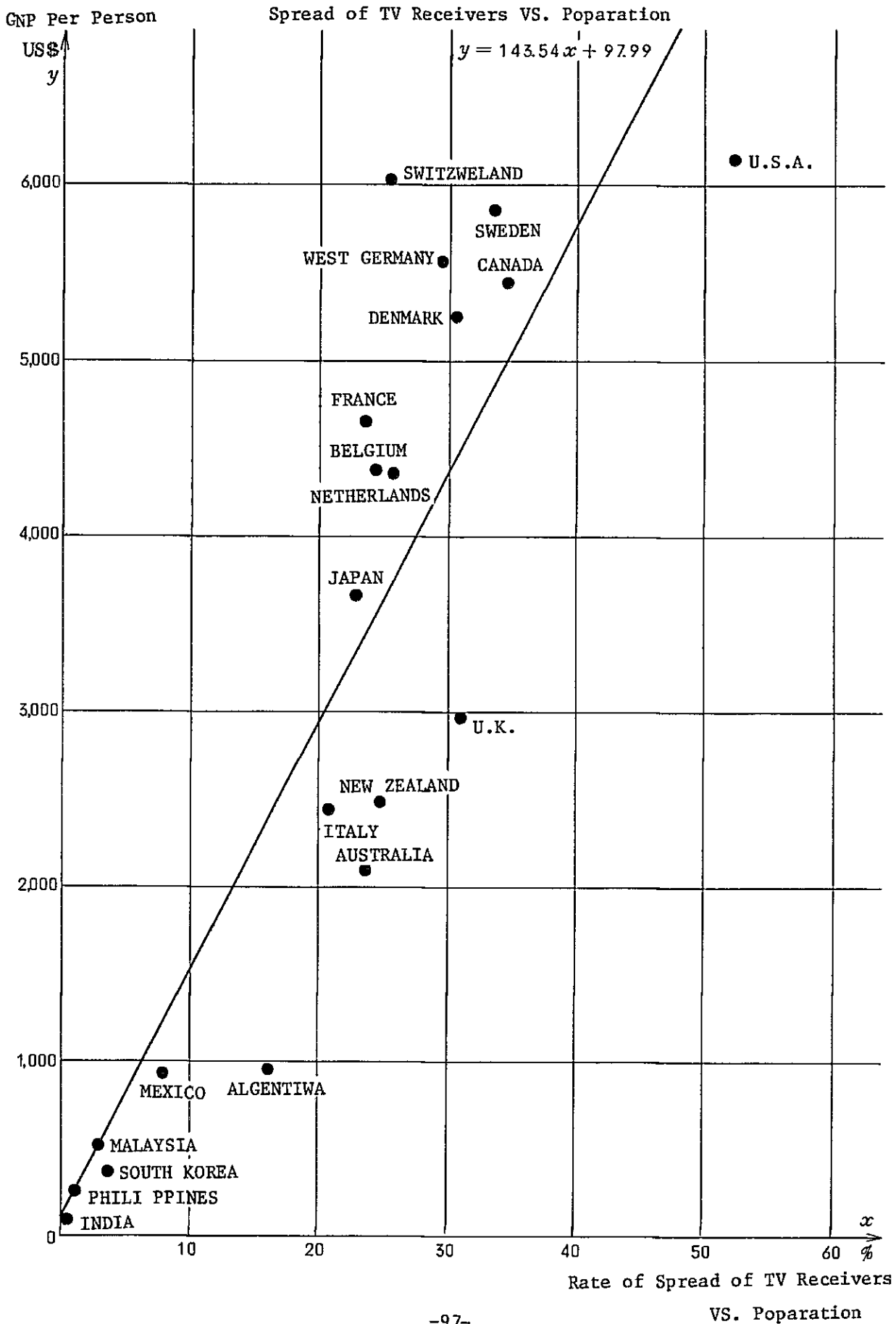

Table 14 GNP's per Person and Rate of Spread of TV
Receivers vs. Population

No.	Country	Rate of Spread of TV Receivers vs. Population (%)	GNP per Person (\$)
1	Japan	22.9	3,660
2	U.S.A.	52.3	6,154
3	England	30.9	2,994
4	West Germany	29.8	5,554
5	France	23.7	4,660
6	Italy	20.8	2,415
7	Belgium	24.4	4,379
8	Netherland	25.8	4,366
9	Denmark	30.4	5,254
10	Sweden	33.9	5,869
11	Switzerland	25.3	6,036
12	Kanada	34.8	5,436
13	Australia	23.7	2,078
14	New Zealand	24.7	2,467
15	Mexico	8.0	915
16	Argentina	16.3	976
17	India	0.03	99
18	Malaysia	3.1	529
19	Philippines	1.1	257
20	Korea	3.6	379

Table 15 Estimation of Spread of TV Receivers

	Population (Thousand) (Increase ratio: 1.8%)	GNP (\$ million) (Increase ratio: 13.7%)	GNP/CAP (\$)	Rate of Spread (%)	Total Number of TV Receivers (Thousand)
1977	13,971	3,387	242	(1.00)	(140)
1978	14,222	3,851	271	(1.21)	(172)
1979	14,478	4,379	302	1.42	206
1980	14,739	4,979	338	1.67	246
1981	15,004	5,661	377	1.94	291
1982	15,274	6,437	421	2.25	344
1983	15,549	7,319	471	2.60	404
1984	15,829	8,322	526	2.98	472
1985	16,114	9,462	587	3.41	549
1986	16,404	10,758	656	3.89	638
1987	16,699	12,232	732	4.42	738
1988	17,000	13,908	818	5.02	853
1989	17,306	15,813	914	5.68	983
1990	17,618	17,979	1,020	6.42	1,131

Table 16 Household Constitution for Different Strata of Income

Stratum of Income (Rs per month)	Percentage of Households(%)	Stratum of Income (Rs per month)	Percentage of Households(%)
~ 100	26.28	~ 200	26.28
100 ~ 200	29.40	200 ~ 400	29.40
200 ~ 300	21.54	400 ~ 600	21.54
300 ~ 400	11.44	600 ~ 800	11.44
400 ~ 500	4.96	800~1,000	4.96
500 ~ 600	2.66	1,000~1,200	2.66
600 ~ 700	1.31	1,200~1,400	1.31
700 ~ 800	0.60	1,400~1,600	0.60
800 ~ 900	0.42	1,600~1,800	0.42
900~1,000	0.31	1,800~2,000	0.31
1,000~1,250	0.48	2,000~2,500	0.48
1,250~1,500	0.20	2,500~3,000	0.20
1,500~	0.40	3,000~	0.40

(As of 1973)

(Estimation for 1977)

Table 17 Percentage of Households Capable of Possessing TV Receivers (1977)

Stratum of Income (Rs per month)	Percentage of Households (%)	Percentage of Households Capable of Possessing TV Receivers	
		v. Households in the Corresponding Stratum of Income	vs. All Households
200	26.28	0	0
200 ~ 400	29.40	0	0
400 ~ 600	21.54	0	0
600 ~ 800	11.44	5	0.57
800 ~ 1,000	4.96	25	1.24
1,000 ~ 1,200	2.66	40	1.06
1,200 ~ 1,400	1.31	50	0.66
1,400 ~ 1,600	0.60	55	0.33
1,600 ~ 1,800	0.42	60	0.25
1,800 ~ 2,000	0.31	65	0.20
2,000 ~ 2,500	0.48	70	0.34
2,500 ~ 3,000	0.20	85	0.17
3,000 ~	0.40	90	0.36
Total	100.00		5.18

4-2-2 Popularization Plan

Rapid spread of TV receivers can not be expected for the time being in Sri Lanka as estimated from the economic condition of the country in the foregoing paragraphs. In order to progress the spread of TV receivers, it is necessary to take some measures or others. The following will be useful for expediting the spread of TV receivers among people.

(1) Installation of TV receivers at public institutions

By installing TV receivers at municipal halls, schools and other public institutions, people's interest in television will be raised, which will expedite the spread of TV receivers into local communities.

(2) Installation of TV receivers at busiest quarters

By installing TV receivers at busiest quarters in urban areas, stimulation will be given to people to raise the desire or will for purchase of TV receivers and thus progress the spread thereof.

- (3) Introduction of programmes participated in by audience
Formation of programmes participated in by general people will contribute to raising people's interest in television and spreading TV receivers.
- (4) Favourable treatment in tax for price reduction of TV receivers
Although TV receivers may be produced domestically in future, it can not be helped for the time being but TV receivers will be imported from abroad. It is necessary to effect favourable treatment of TV receivers in customs and others for price reduction of TV receivers.
- (5) Establishment of "aftercare" system for repair, etc., of receivers
It is important to provide training courses by SLBC engineers for techniques for repair, etc., thus for establishing an ample aftercare scheme.

4-3 Personnel Training

From the standpoint of smooth management and reduction in expenses, such personnel engaged in radio broadcasting that are capable of working concurrently for television broadcasting should desirably be assigned to the project. The rest of personnel to be engaged in television broadcasting should be selected among SLBC staff (299 Technical Personnel plus 306 programme personnel).

The following are general requirements for personnel for television broadcasting,

- (1) Personnel having experience in radio broadcasting operation
- (2) Personnel having grounding or knowledge on television broadcasting
- (3) Personnel with ample aptitude for team work

Since it is desired that personnel should be well acquainted with television broadcasting service in as short a time as possible, experience in radio broadcasting operation is the most important requirement. In the field of TV Programme production, programmes are produced by a larger number of personnel than in radio broadcasting and ample aptitude for team work is required. A list of personnel necessary at the early stage of television broadcasting is given in Table 18.

For personnel training, the following two types of training will be effective.

(1) Overseas training

This type of training is conducted at foreign broadcasting organizations to acquire knowledge and techniques on television broadcasting. Since the trainees of the overseas training are expected to be in charge of on-the-job training when they return home, it is necessary to complete the overseas training before the television broadcasting started.

(2) On-the-job training

The following types of on-the-job training will be conducted to broadcasting personnel under those personnel having completed overseas training.

- 1) Before starting broadcasting service
 - a) General knowledge on television broadcasting.
 - b) Techniques related to operation and maintenance of equipment to be installed at studio and transmitting stations.
 - 2) After starting broadcasting service
 - a) Training of transmitter engineers at an attended transmitting station (Kokavil).
 - b) Training of assistant producers in programme production at the studio
- (3) Others

It is very advantageous for the development of a broadcast organization, to send their management staff to overseas countries for study of administrative and operating schemes of these countries. A schedule for television broadcasting personnel training necessary for the preparation of the initial broadcasting plan is given in Table 19.

Table 18 List of Broadcasting Personnel

1. Personnel for Programme Production

(A) News programmes		Studio 2 live and VTR
(1) Producer	1	Every other day 2 persons in total (SLBC concurrent)
(2) Assistant producer	1	" 2 persons in total (SLBC concurrent)
<u>Note:</u> Including recording operation of news programme.		
(B) Adult education (2) ~ (9).		See Table 1-3-1.
(1) Producer	8	(SLBC concurrent)
(2) Assistant producer	8	(SLBC concurrent)
(C) Official report and information		Studio 2 live
(1) Producer	1	Every other day 2 persons in total (SLBC concurrent)
(2) Assistant producer	1	" 2 persons in total (SLBC concurrent)
(D) Entertainment (1) ~ (4)		
(1) Producer	4	(SLBC concurrent)
(2) Assistant producer	4	(SLBC concurrent)
(E) Entertainment (5) and Sport		
(1) Producer	1	(SLBC concurrent)
(2) Assistant producer	1	(SLBC concurrent)
(F) Rebroadcast programme and adult education (1)		
(1) Producer	1	(SLBC concurrent)
(2) Assistant producer	1	(SLBC concurrent)
<u>Total</u>		
(1) Producer	18	
(2) Assistant producer	18	

2. Technical Personnel

(A) Transmission group (residing at Kokavil Transmitting Station) (in full service)

(1) TD 2

(2) Transmitter engineer 3

Total 5

(B) Master control group (in full service)

(1) TD 1

(2) Master control engineer 3

(3) Telecine engineer 4

(4) VTR engineer 4

Total 12

(C) Maintenance group

(1) Maintenance of transmitter 3 (SLBC concurrent)

(2) Maintenance of studio 3 (SLBC concurrent)

Total 6

(D) Programme production group 1 (in charge of Studio 1) (in full service)

(1) TD 1

(2) Cameraman 3

(3) Mixer 1 (SLBC concurrent)

(4) Mixer assistant 2 (SLBC concurrent)

(5) LD 1

(6) LD assistant 2

Total 10

(E) Programme production group 2 (in charge of Studio 2) (in full service)

(1) TD 1

(2) Cameraman 2

(3) Mixer 1

(4) Mixer assistant 1

(5) LD 1

(6) LD assistant 1

Total 7

(F) ENG production group (Personnel in charge of ENG or standing by for production) (in full service)

(1) TD	1
(2) Cameraman	1
(3) Mixer	1 (SLBC concurrent)
(4) Mixer assistant	1 (SLBC concurrent)
(5) LD	1
(6) LD assistant	1
<hr/>	
Total	6

(G) Art group

(1) Makeup designer	3 (in full service)
(2) Stage designer	2 (SLBC concurrent)
(3) Stage carpenter	4 (SLBC concurrent)
(4) Property man	2 (SLBC concurrent)
<hr/>	
Total	11

3. Necessary Number of Personnel

(1) Personnel for programme production	36
(2) Engineers	57
<hr/>	
Total	93

Note: Assumed working conditions for personnel

1. One holiday per week

2. Working scheme

(1) Programme production personnel

(A) News and official report and Information programmes
Every-other-day shift (TV in full service)

(B) Separate programmes (adult education, entertainment, etc.)
In charge of one programme during a week (SLBC concurrent)

(2) Technical personnel

By bar chart

(Audio engineers and art group in TV are covered by SLBC personnel concurrently and other personnel in TV are in full service)

Table 19 Television Broadcasting Personnel Training Schedule (Phase 1)

Type of Occupation	Necessary Number of Personnel		Number of Trainees		Remarks
	Concurrent	Full Service	Overseas Training	On-the-Job Training	
Producer	18		18		
Assistant producer	18			18	
Transmitter engineer		5	2	3	
Master control engineer		4	1	3	
Telecine personnel		4		4	
VTR personnel		4	2	2	
Personnel for maintenance of transmitter	3		1	2	
Personnel for maintenance of studio	3		1	2	
TD		3	3		
Cameraman		6		6	
LD		3	3		
LD assis ant		4		4	
Mixer	3			3	
Mixer assistant	4			4	
Makeup		3	2	1	
Stage designer	2		1	1	
Stage carpenter	4			4	
Property man	2			2	
Subtotal	57	36	34	59	
Ground total		93		93	

SECTION 5 ECONOMIC EVALUATION

Television broadcasting gives a larger influence to people than other mass media because of the instantaneousness, simultaneousness, diffusibility and information transmission capability of the radio signal used for television broadcasting. For economic evaluation of a television broadcasting service, comparison of the estimated expenditure for the broadcasting service with benefits to be brought about is useful.

In the case of television broadcasting service, the benefits should comprise receiving charge, commercial fee, and also the effects of broadcasting in a figured form. However, varieties of effects of television broadcasting are given to people and these effects are not uniform and different for different people. In addition, it is extremely difficult to figure out the value of the respective types of information broadcast by television, and measure and express quantitatively the degree of contribution of television broadcasting to economy, education, culture, and regional development, etc. Accordingly, analysis is limited here only to qualitative analysis of the effects of television broadcasting.

When television broadcasting is introduced in Sri Lanka, a considerably large influence will be given to the politics, economy, and culture of the country by the mass media of television. Of course, the influence may change with the contents of programmes to be telecast, broadcasting hours, coverage of the broadcasting network, etc.

Let us now consider the effects of television broadcasting on the premisis that dominating programmes will be technical education in agriculture, fishing, etc., the broadcasting will be performed for three (3) hours a day, and about 87% of the whole population of the country will be covered by the broadcasting network.

(1) Mutual understanding among people

At present, Sri Lankan has Sinhala, Tamil and other races. These races have their own peculiarity in language, culture, etc. By introducing such a mighty information medium as television and introducing the cultures unique to respective races, mutual understanding among people can be achieved.

(2) Uniformity of culture

The cultural level in Sri Lanka greatly differs from area to area. In particular, differences in culture between Colombo and other areas are remarkable. The advantage of television as an information medium capable of sending identical information to all viewers at a time in a nationwide scale by overcoming distance in time and space will contribute to solving

regional differences in cultural level and forming a unified cultural zone of a nationwide scale in Sri Lanka.

(3) Spread of education and enhancement of culture

The Government of Sri Lanka expends about 15% of the entire ordinary expenditure as annual educational expense for enriching and enhancing education in the country. Governmental elementary schools, junior highschools and senior highschools have been established throughout the country, and education is conducted free of charge. The percentage of school attendance reaches over 70%. Thus the Government of Sri Lanka has been putting a great stress on the spread of education. By introducing television into school education and compiling and putting into the curriculum most suitable educational programmes by close cooperation between the broadcaster and school authorities, spread of education and development of the national educational level can be enhanced.

In addition, a great volume of information and knowledge can be presented to people to allow them to deepen their culture through news and cultural TV programmes.

(4) Enrichment of home life by entertainment

At present, there are about 350 cinema houses in Sri Lanka, which are all enjoying prosperity. This proves how much people wish for entertainment. Television broadcasting will answer people in achieving entertainment. When brought into home, television will enrich home life with tastefulness.

(5) Briskness of economic activities

By conducting technical education of agriculture, fishery, and small-scale industries through television broadcasting, human resources can be secured, production techniques in respective fields can be developed, and thus the productivity can be raised.

By broadcasting commercials, the will of consumers for purchase is stimulated, the demand can be increased, and thus economical activities can be made brisk.

The introduction of television broadcasting by the Government of Sri Lanka is aimed at developing the overall development plan of the country and achieving positive cooperation of people through achievement of understanding and recognition of people for the national project. The introduction of television is a national scheme and it is desirable to operate television broadcasting by a public organization or corporation. Insufficiency of receiving charges and commercial fees will be subsidized by the National Treasury. In consideration of unmeasurable contribution to be given by television to national measures or policies, the overall evaluation of television broadcasting is extremely high, and thus realization of this project at an early time is anticipated.

۱۱۹