

DRAWING 8b. COAL SEAM COLUMNAR SECTION OF DD25
Scale = 1:20

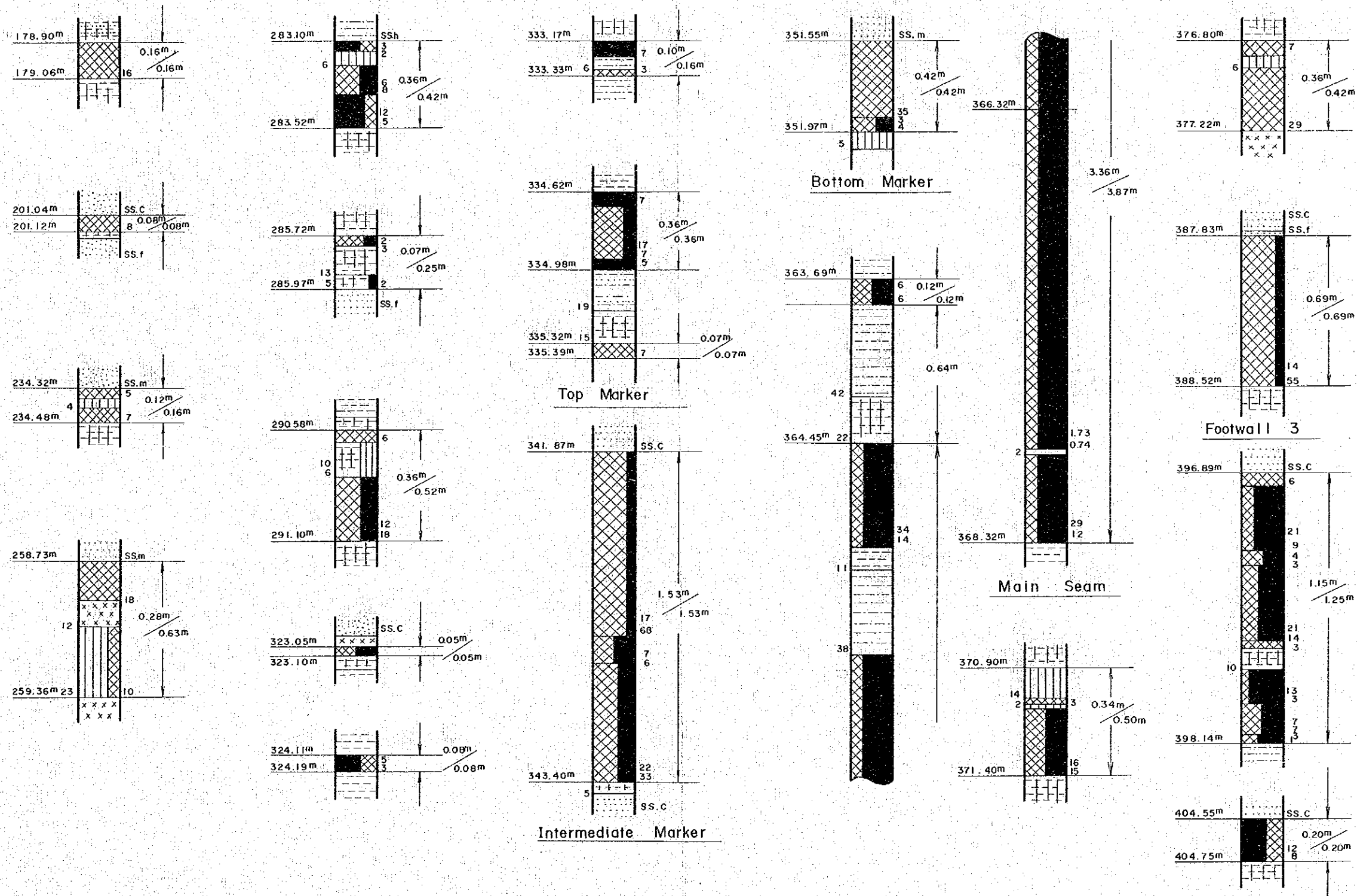

DRAWING 8m. COAL SEAM COLUMNAR SECTION OF DD26

Scale = 1 : 20

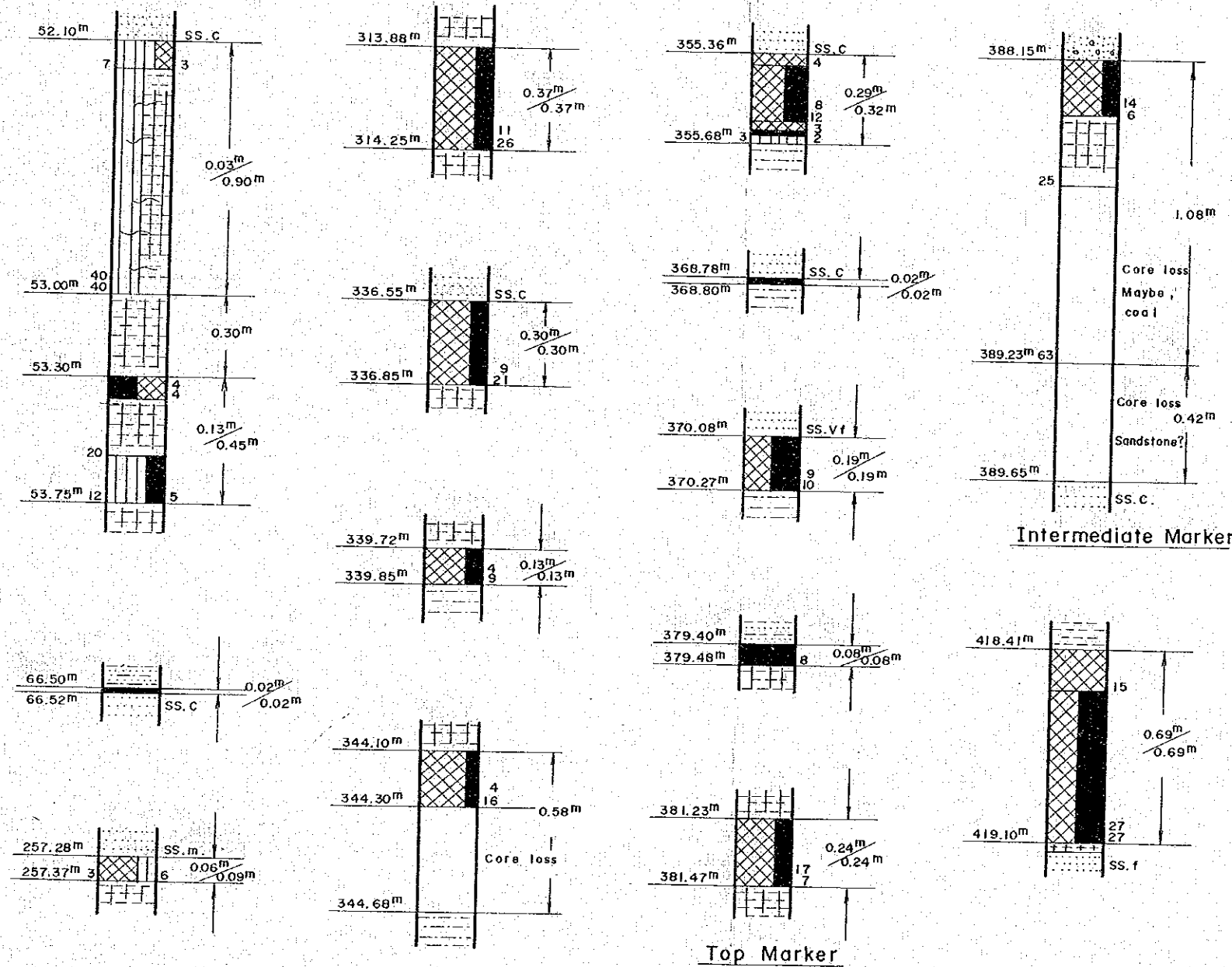

DRAWING 8n COAL SEAM COLUMNAR SECTION OF DD28

Scale = 1:20

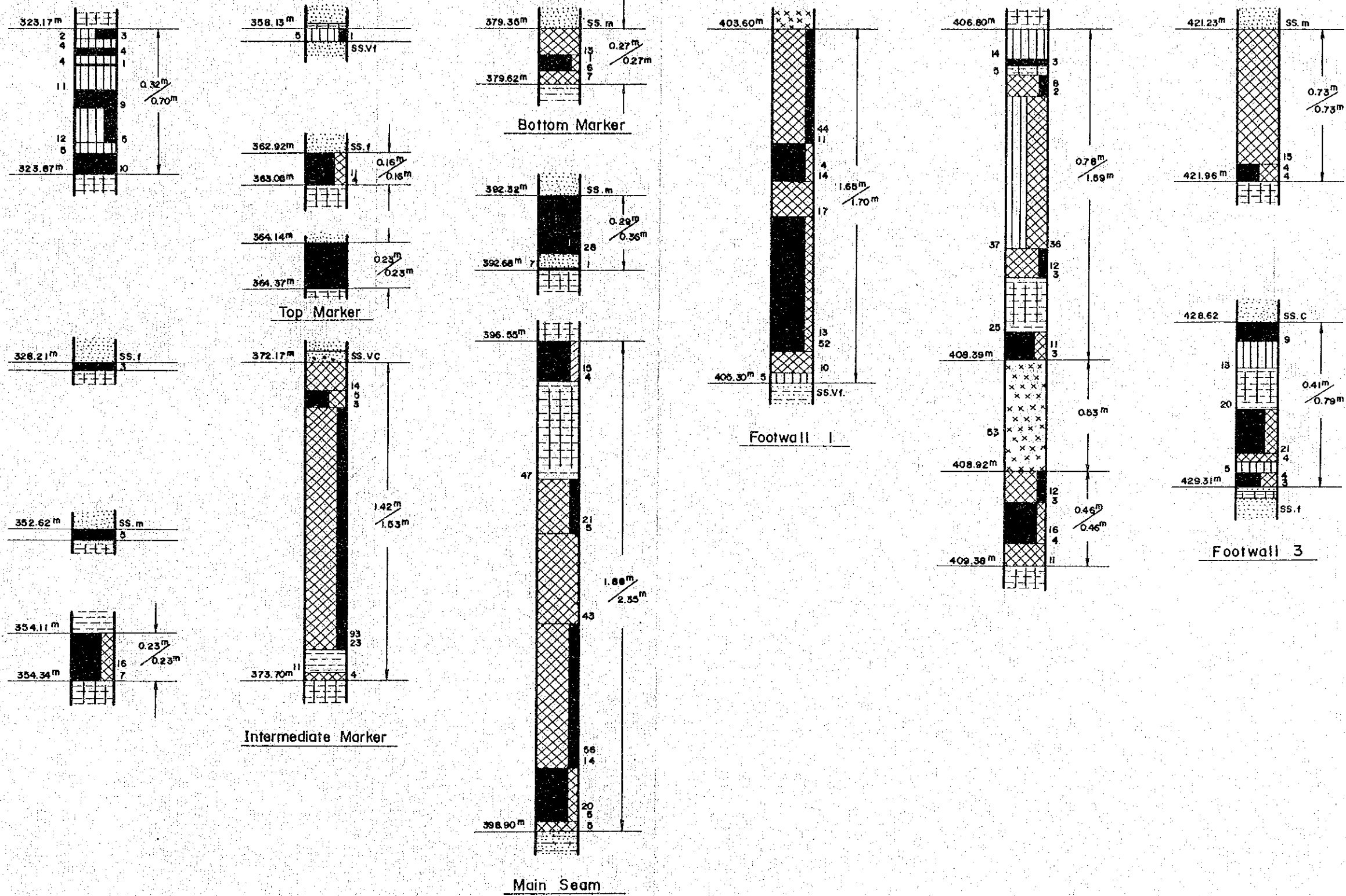

DRAWING 80. COAL SEAM COLUMNAR SECTION OF DD29

Scale = 1 : 20

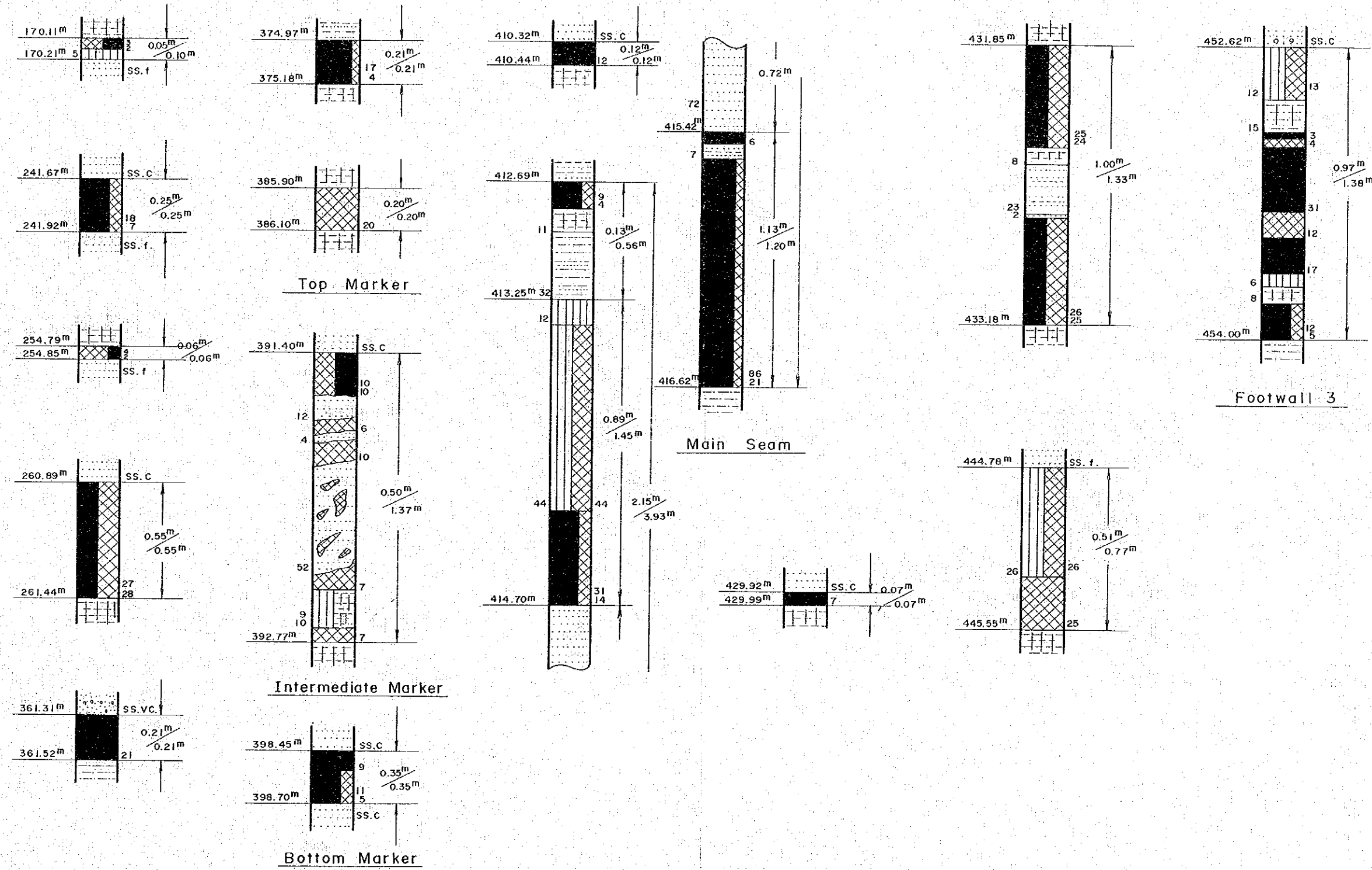

DRAWING 8p. COAL SEAM COLUMNAR SECTION OF DD31
 Scale = 1 : 20

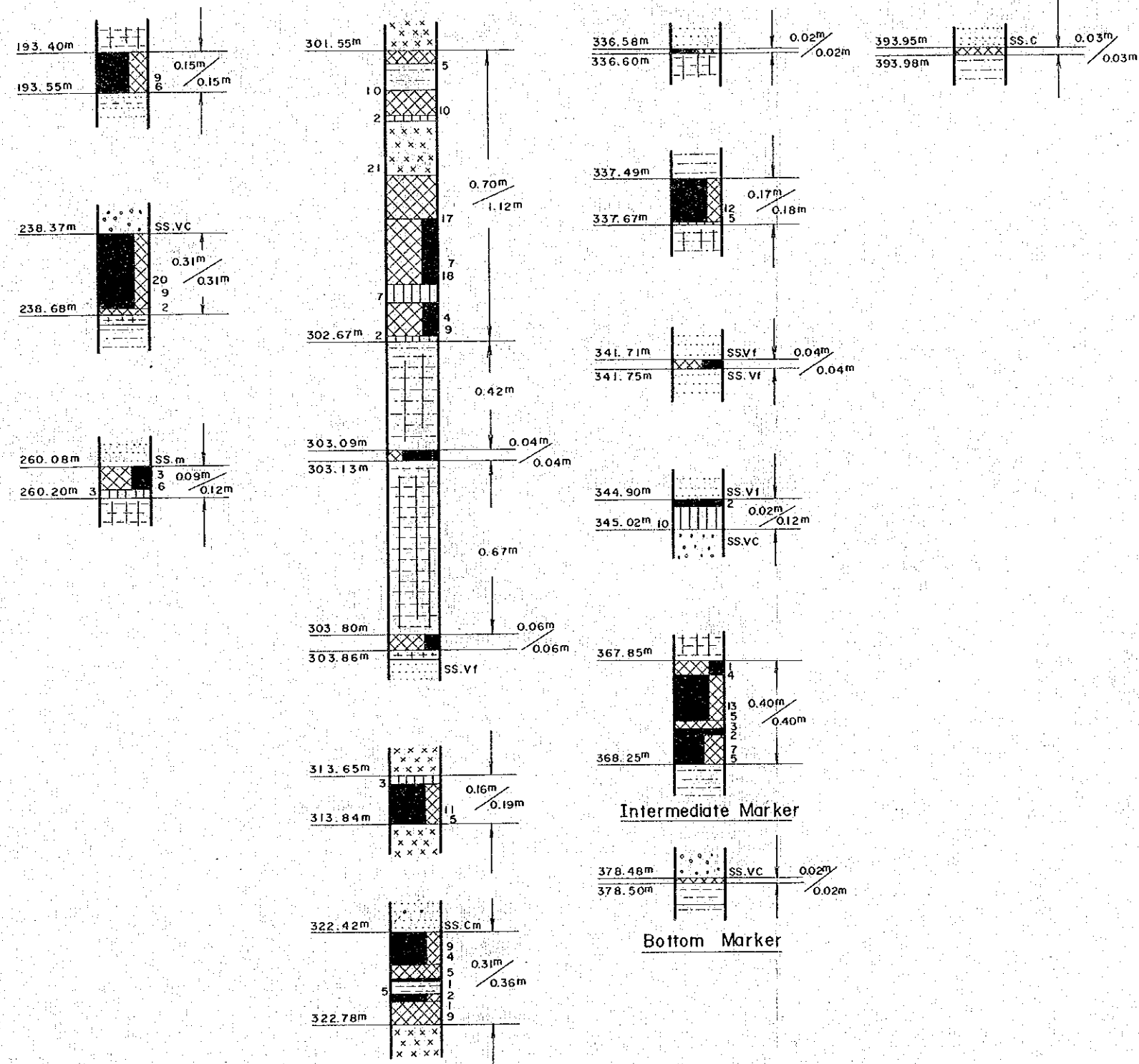

DRAWING 8q. COAL SEAM COLUMNAR SECTION OF DD36

Scale = 1:20

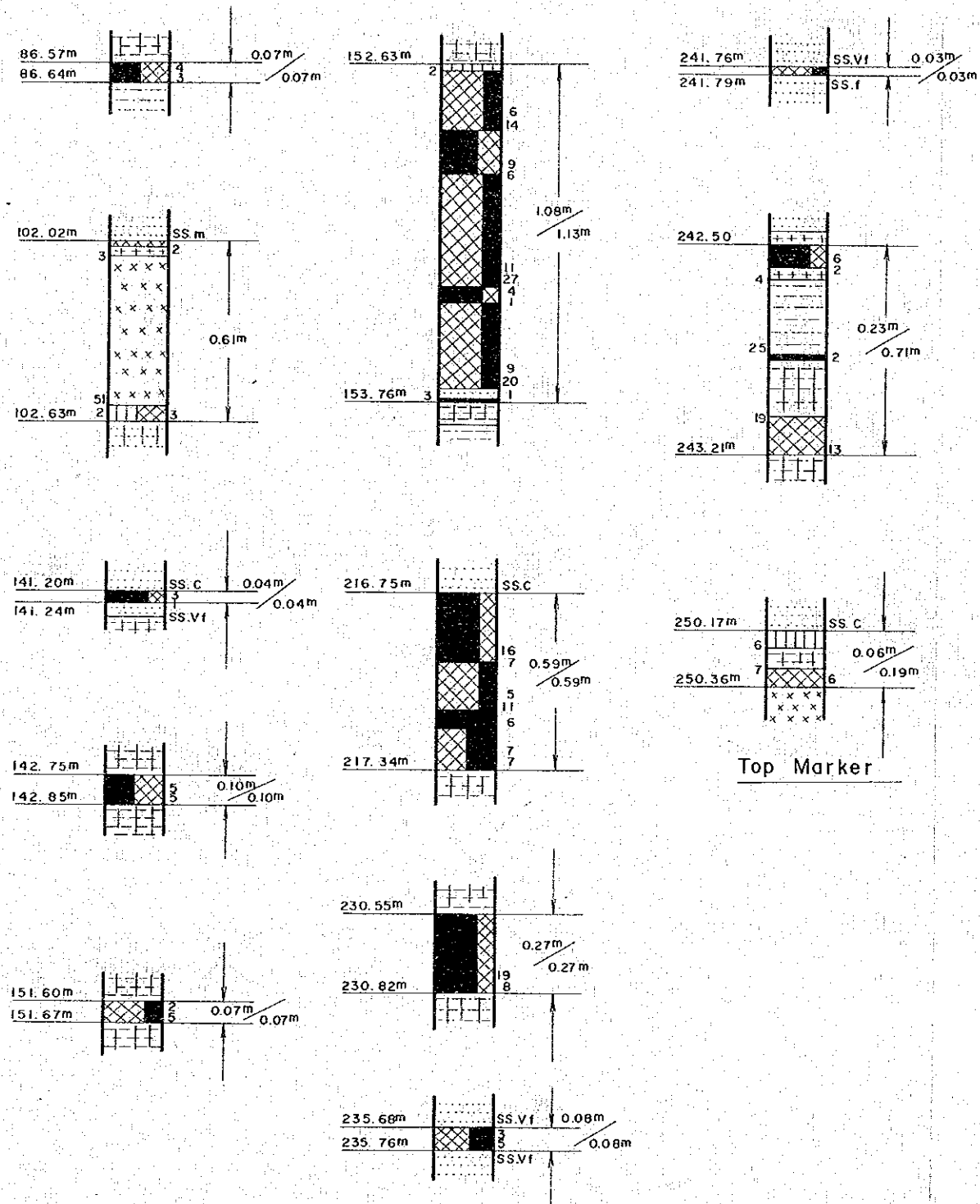

DRAWING 8r. COAL SEAM COLUMNAR SECTION OF DD 38

Scale 1 : 20

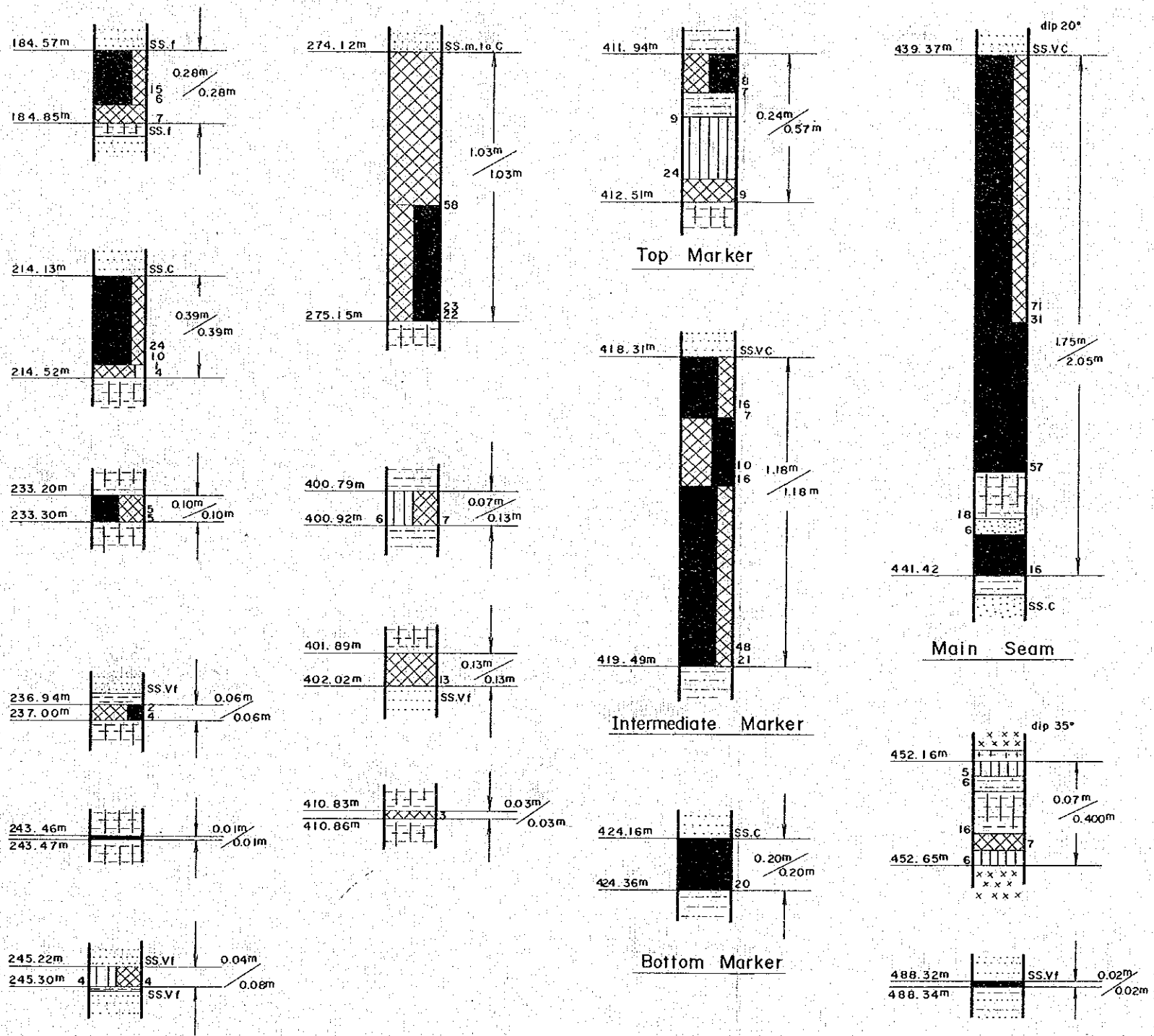

DRAWING 8s. COAL SEAM COLUMNAR SECTION OF DD43

Scale = 1:20

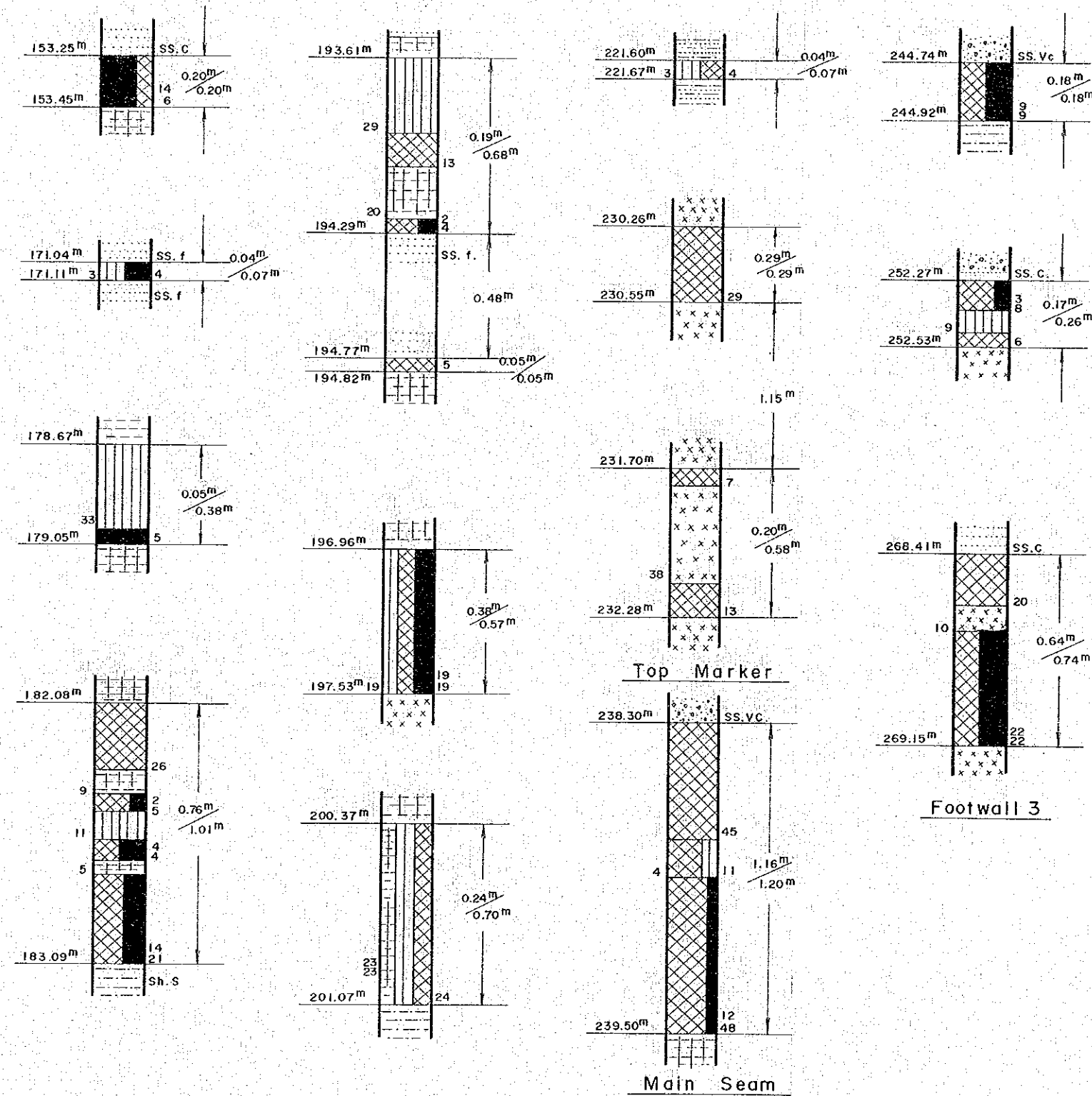

DRAWING 8t. COAL SEAM COLUMNAR SECTION OF DD48

Scale = 1 : 20

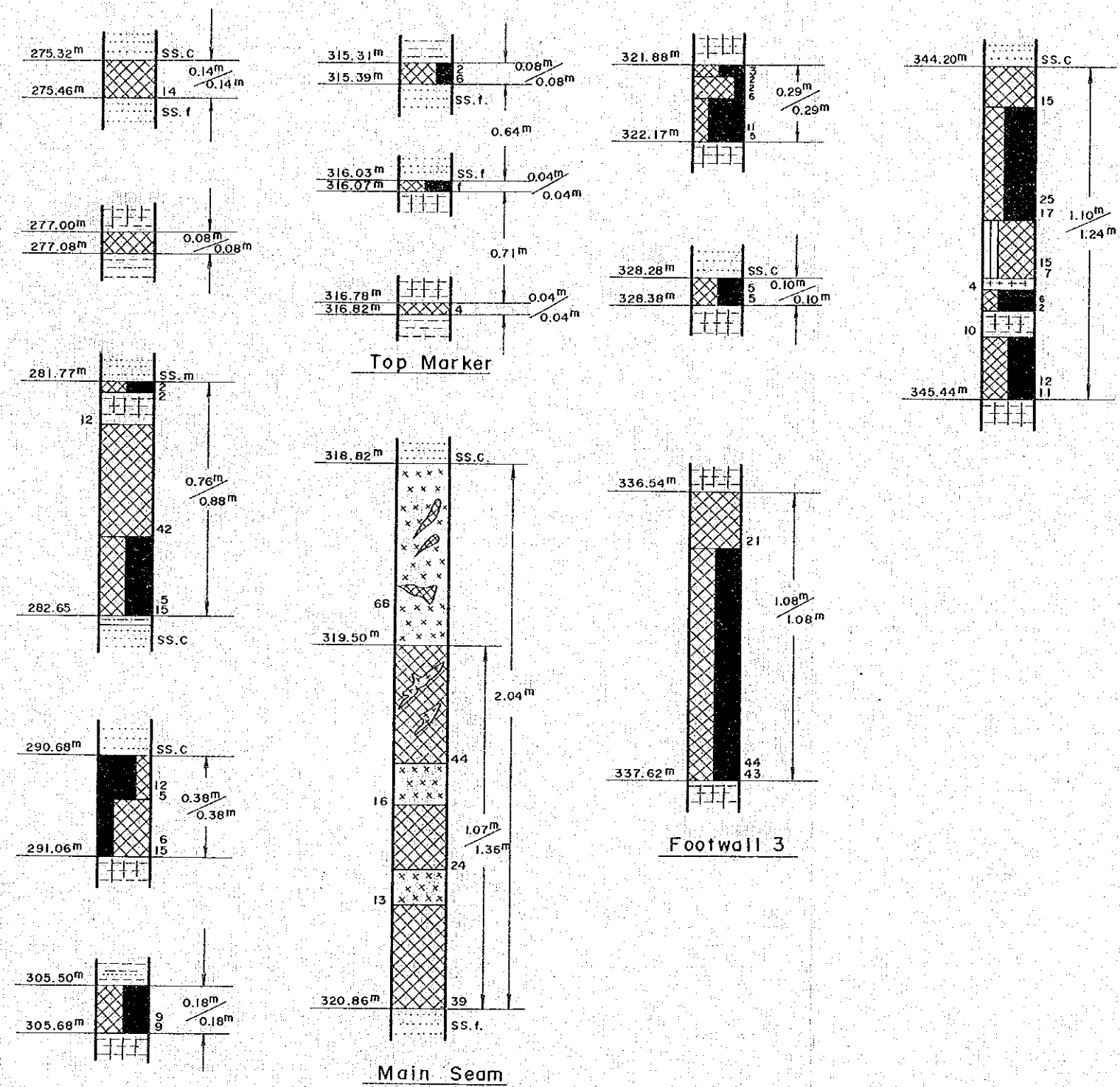

DRAWING 8w. COAL SEAM COLUMNAR SECTION OF DD51
Scale=1:20

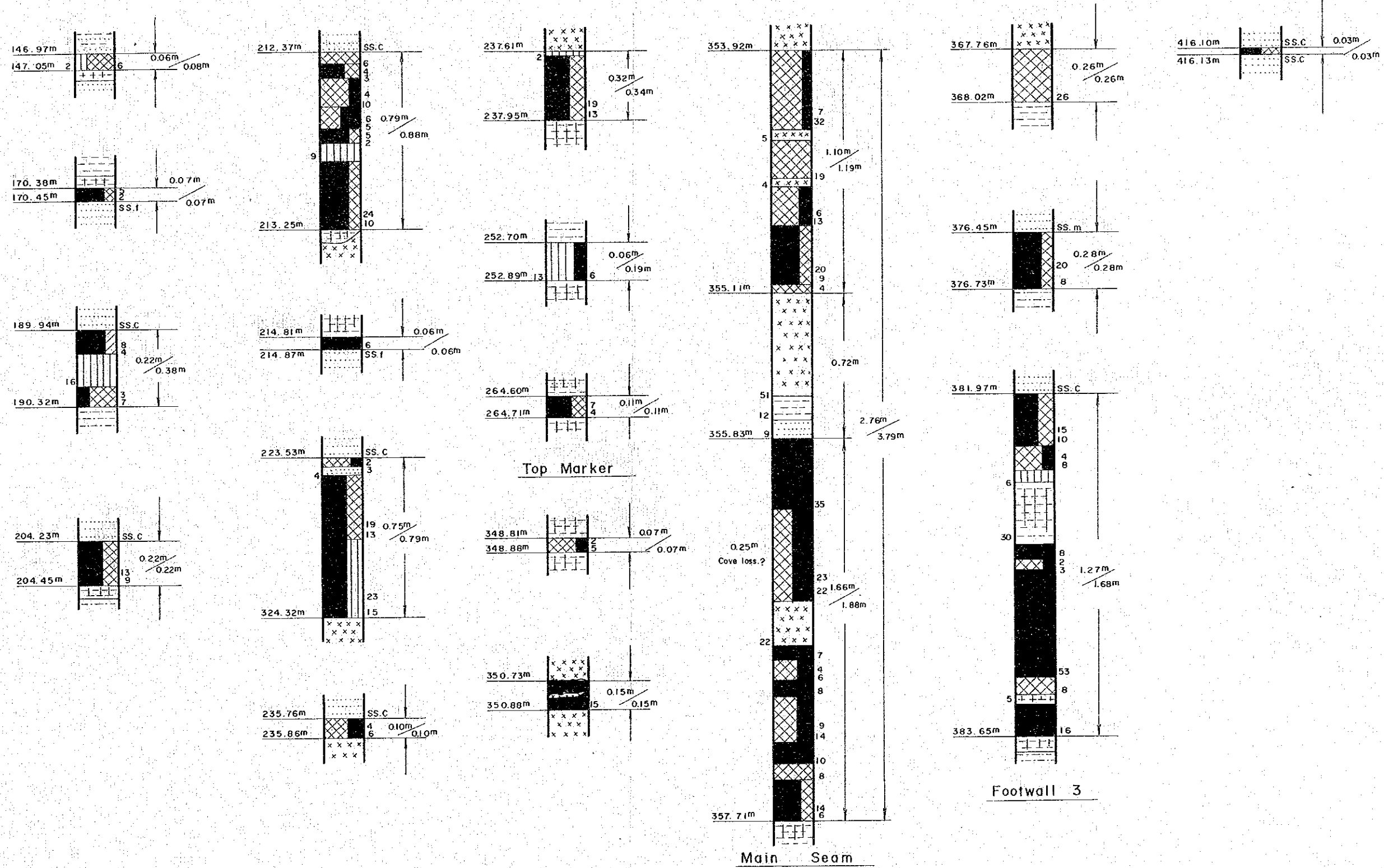

DRAWING 8x. COAL SEAM COLUMNAR SECTION OF DD 52

Scale = 1 : 20

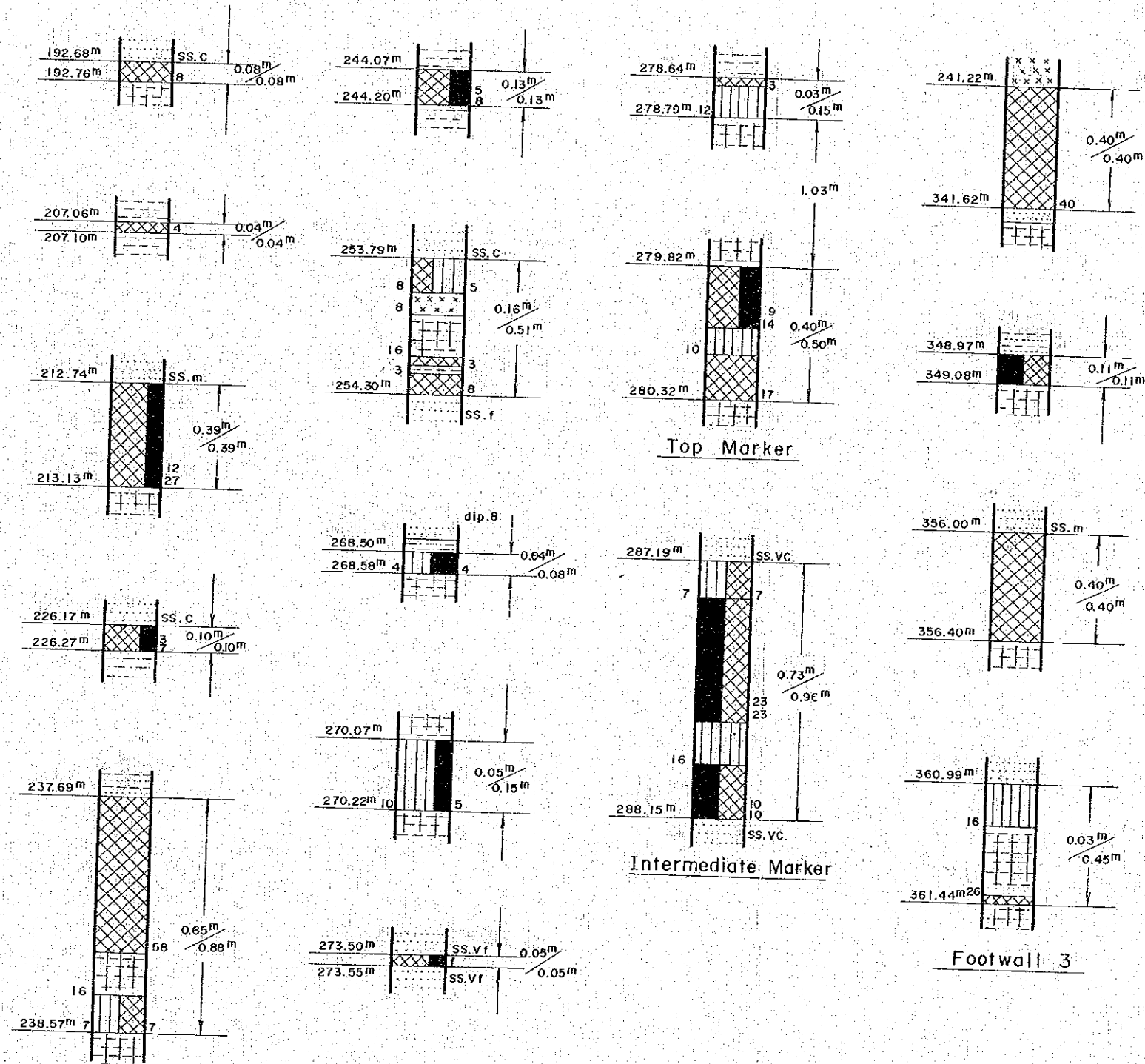

DRAWING 8y. COAL SEAM COLUMNAR SECTION

Scale = 1 : 20

DD 9

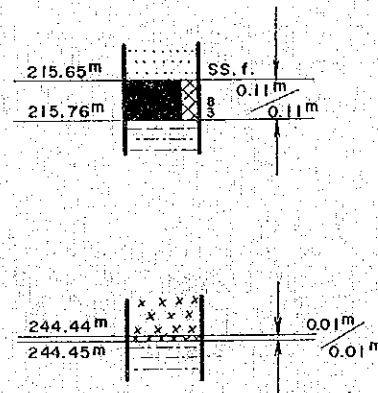

DD 34

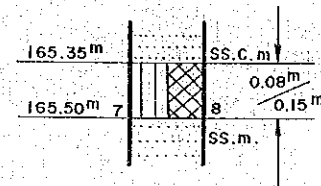

DD 41

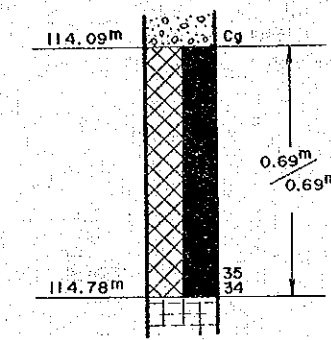
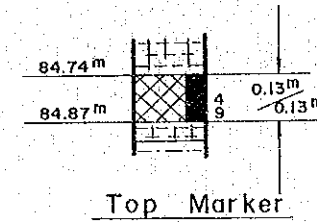
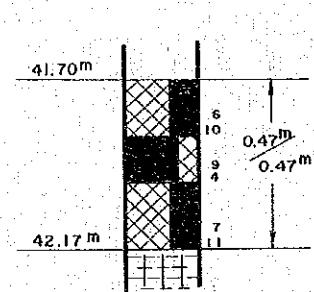

DD 45

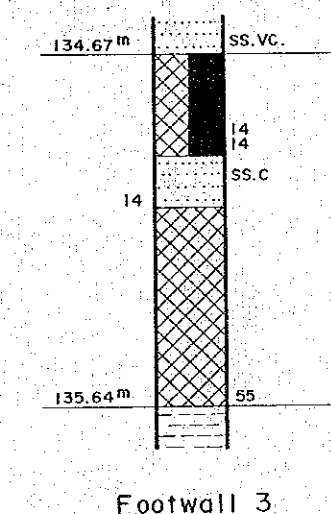
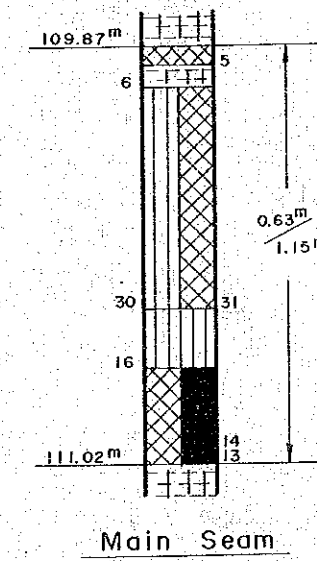
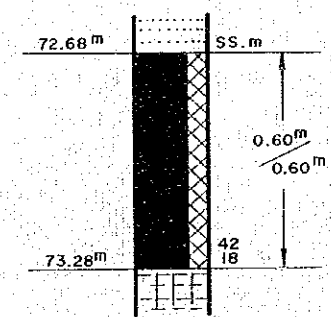
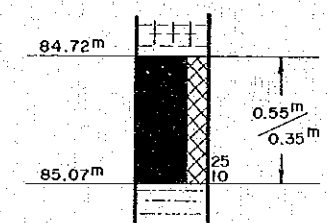
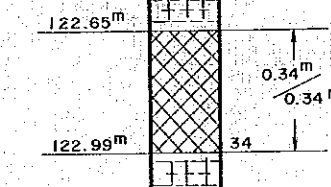
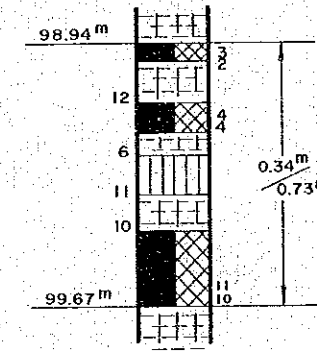
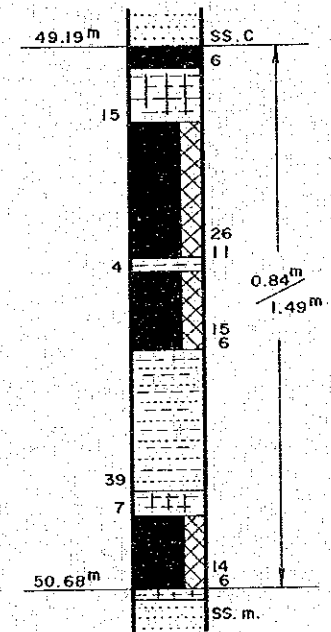
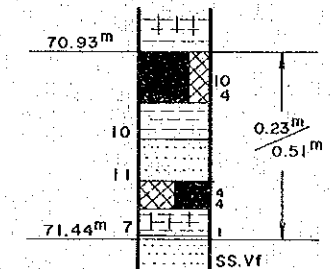

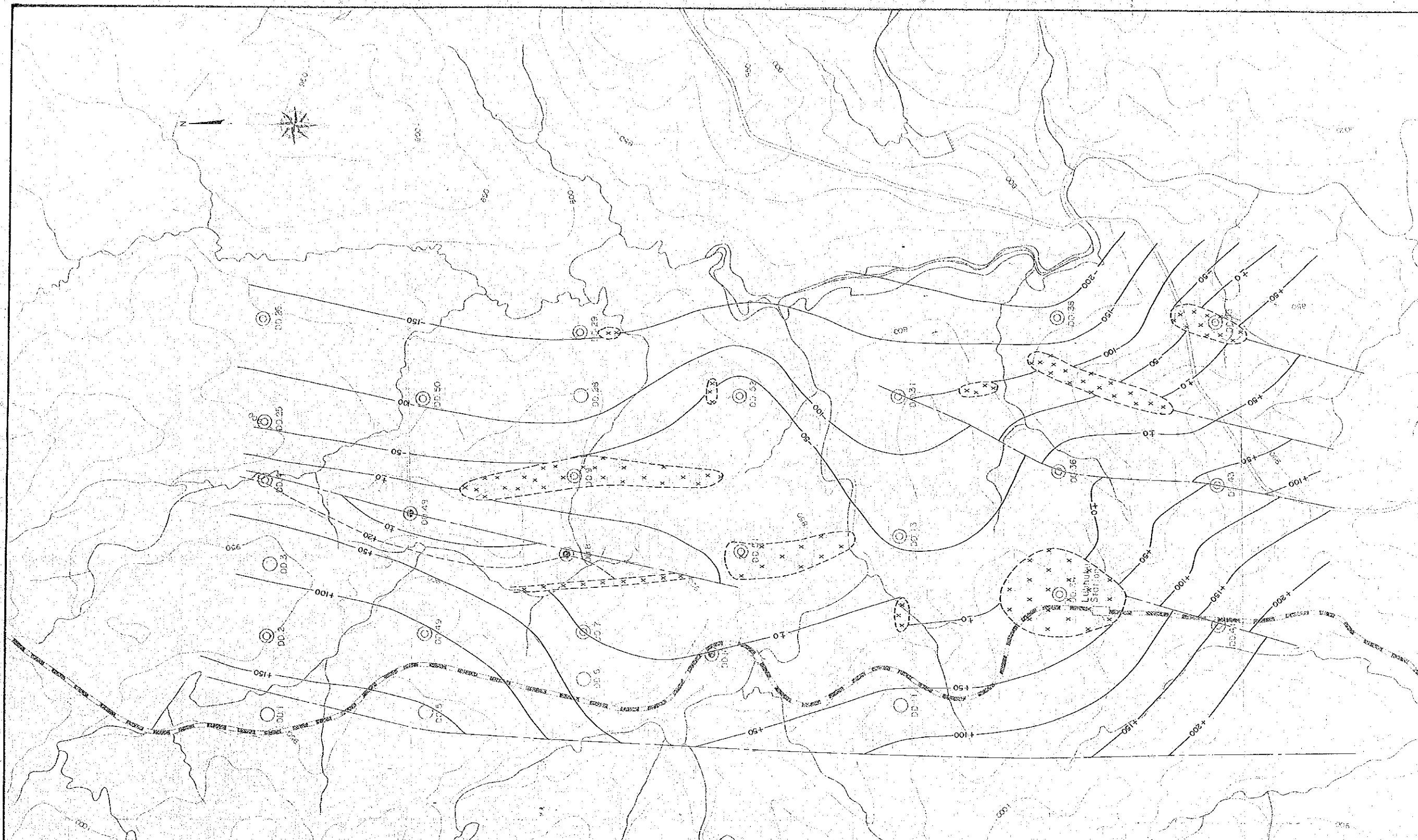

LEGEND

- +50 isodepth. Line in Meter
- ±0 (Floor of the Seam)
- Fault, Assumed
- Coal seam horizon
- Dolerite

(Surface contour in feet)

JAPAN INTERNATIONAL COOPERATION AGENCY

Structure Contour Map
- Intermediate Marker Seam-

Dwg. NO.	9 c	Scale	1 : 25000
Date	Sep., 1962	Prepared by	H. Nozaki
		By	N. Ishihara

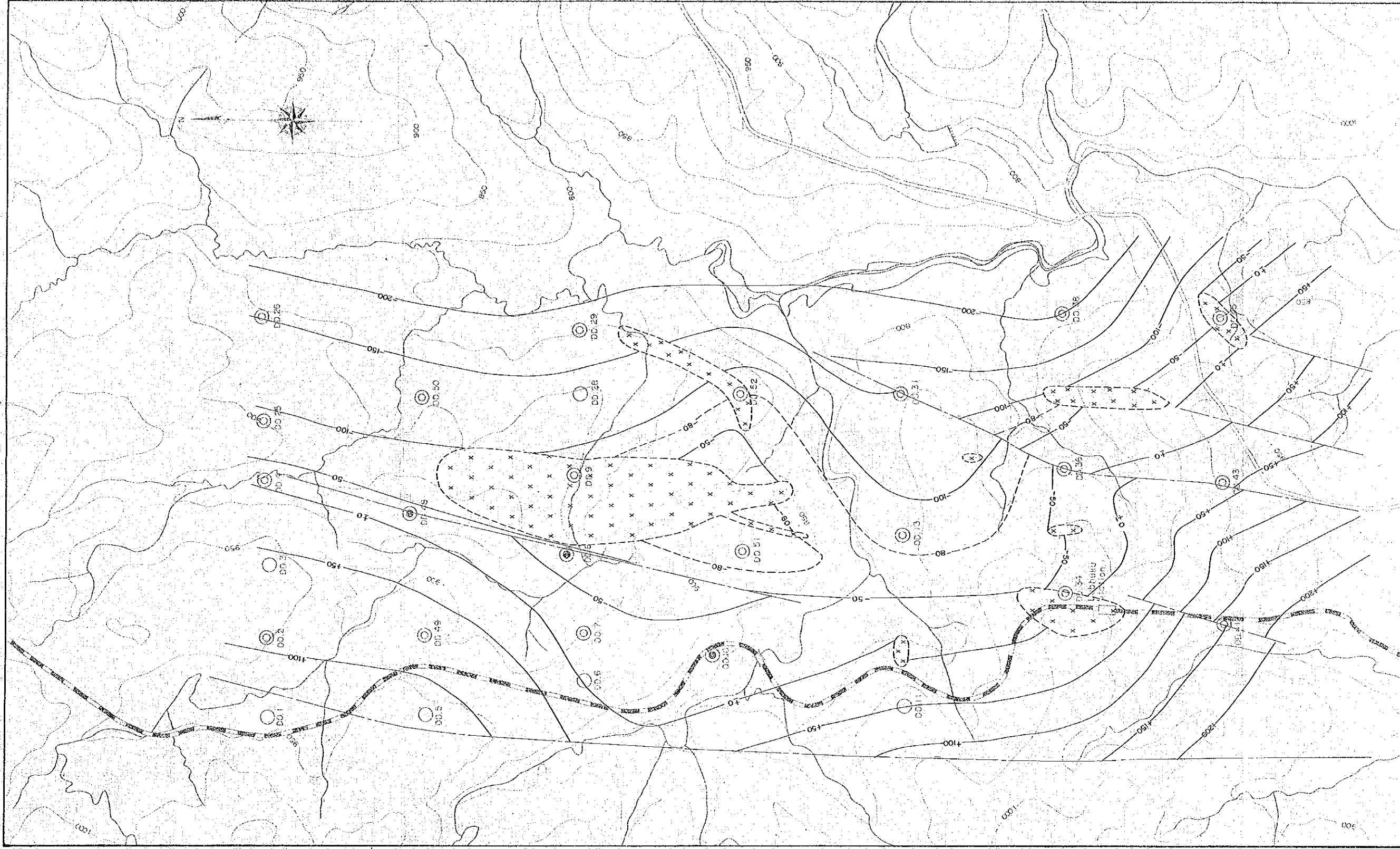

LEGEND

- Isodepth Line in Meter (Floor of the Seam)
- Fault, Assumed (Coal seam horizon)
- Dolerite
- (Surface contour line in feet)

JAPAN INTERNATIONAL COOPERATION AGENCY

Structure Contour Map
- Main Seam -

Dwg. No.	9 b	Scale	1:25,000
Date	See 1982	Prepared By	H. Nozaki
		By	N. Ishihara

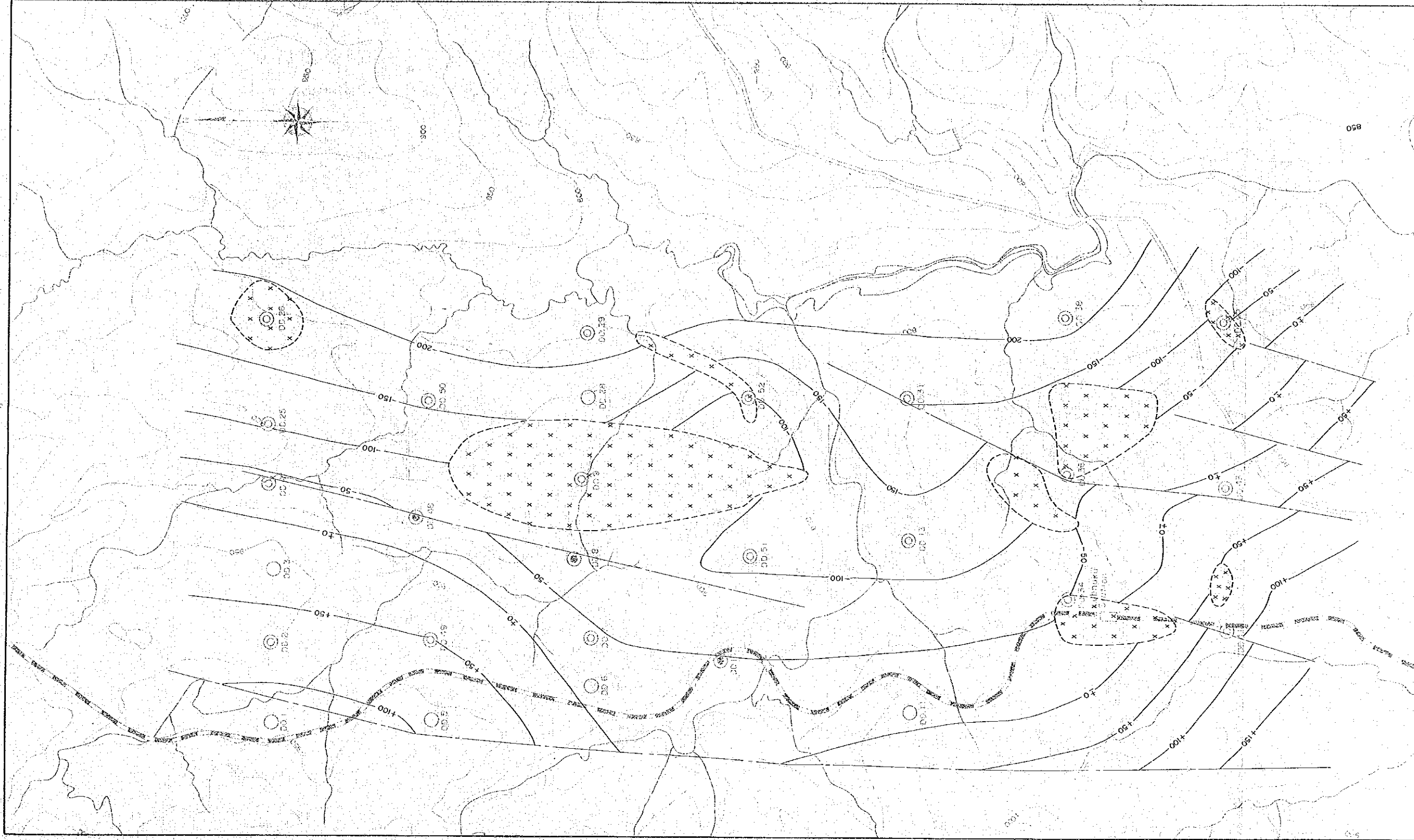

LEGEND

- +50 Isodepth Line in Meter
- +0 (Floor of the seam)
- Fault, Assumed (Coal seam horizon)
- [x x x] Dolerite

(Surface contour in feet)

JAPAN INTERNATIONAL COOPERATION AGENCY

Structure Contour Map
 - Footwall 3 -

Dwg. No.	9C	Scale	1:25,000
Date	Sep. 1982	Prepared by	H. Nozaki
			N. Ishihara

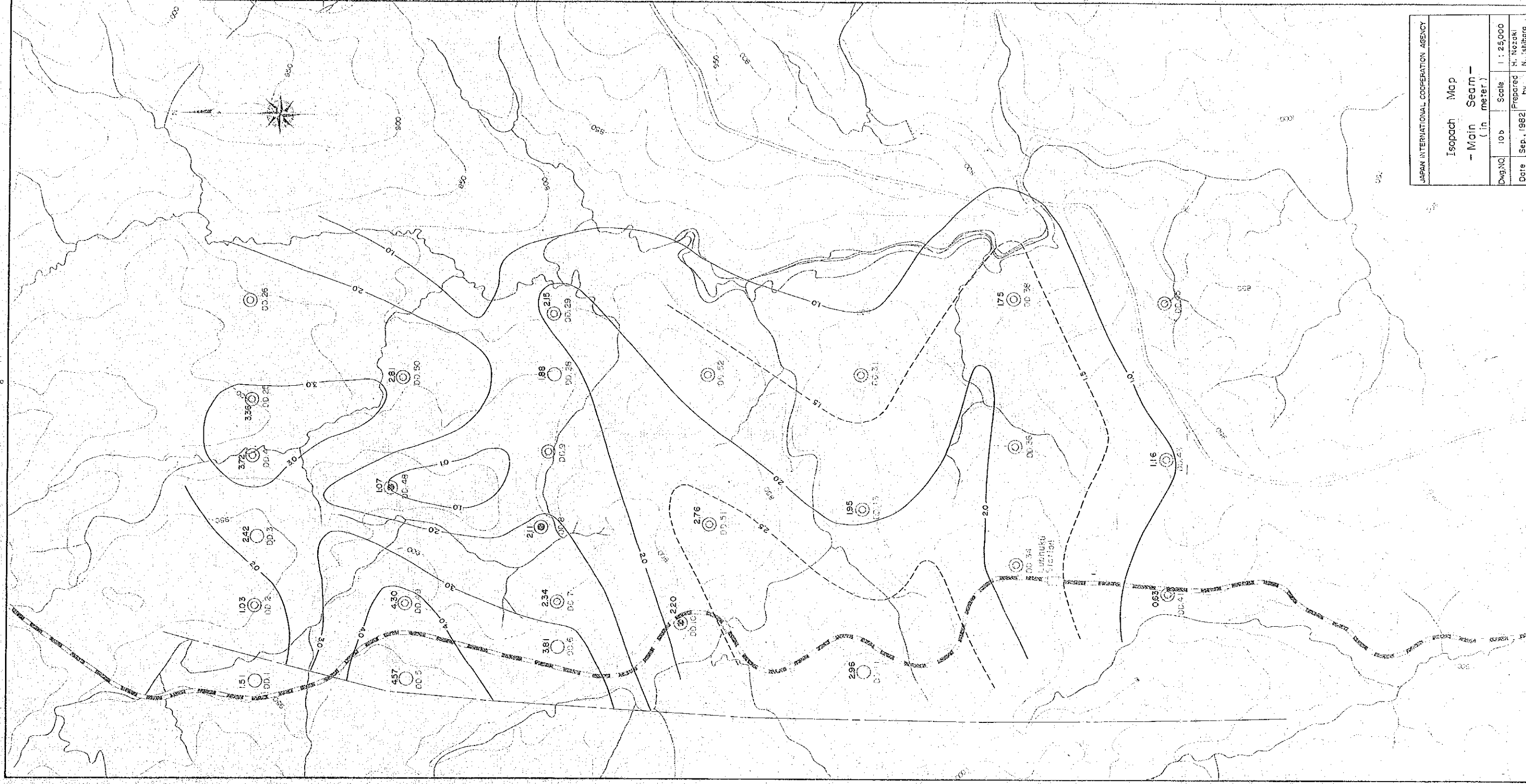

JAPAN INTERNATIONAL COOPERATION AGENCY

Isopach Map
 - Main Seam -
 (in meter)

Dwg. No.	10b	Scale	1 : 25,000
Date	Sep. 1962	Prepared By	H. Nozaki
			N. Ishihara

DD 25

Gamma Ray LSD Caliper

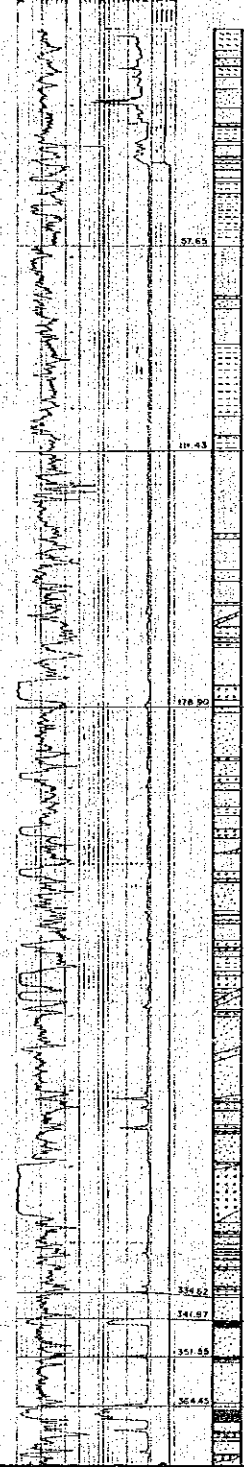

Upper Coal Zone

Upper Transition Beds

DD 49

Gamma Ray LSD Caliper

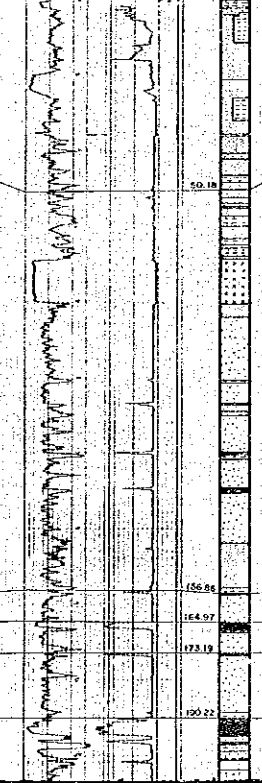

Upper Sandstone

Lower Coal Zone

Top Marker
Intermediate Marker
Bottom Marker

Main Seam

DD 6

Gamma Ray LSD Caliper



DD 13

Gamma Ray LSD Caliper

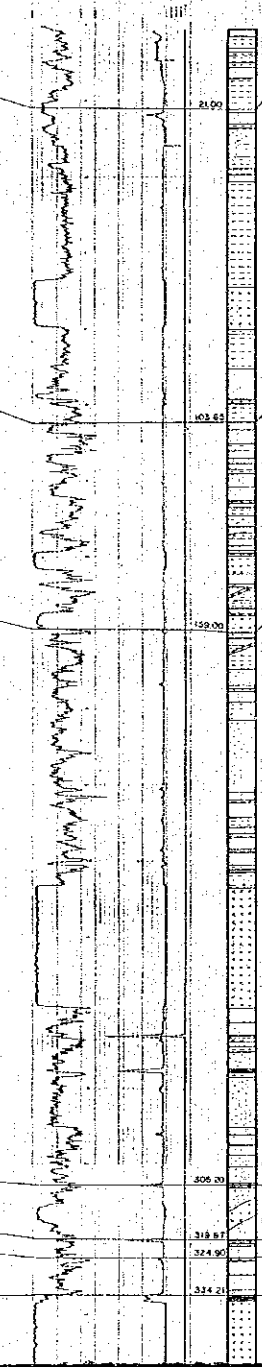

Upper Coal Zone

Upper Transition Beds

Upper Sandstone

Lower Coal Zone

Top Marker

Intermediate Marker
Bottom Marker

Main Seam

DD 38

DD 13

DD 6

DD 49

Upper Coal Zone

Upper Transition Beds

Upper Sandstone

Lower Coal Zone

Top Marker
Intermediate Marker
Bottom Marker

Main Seam

Upper Coal Zone

Upper Transition Beds

Upper Sandstone

Lower Coal Zone

Top Marker
Intermediate Marker
Bottom Marker

Main Seam

Gamma Ray LSD Caliper

Gamma Ray LSD Caliper

Gamma Ray LSD Caliper

Gamma Ray LSD Caliper

