

DUST

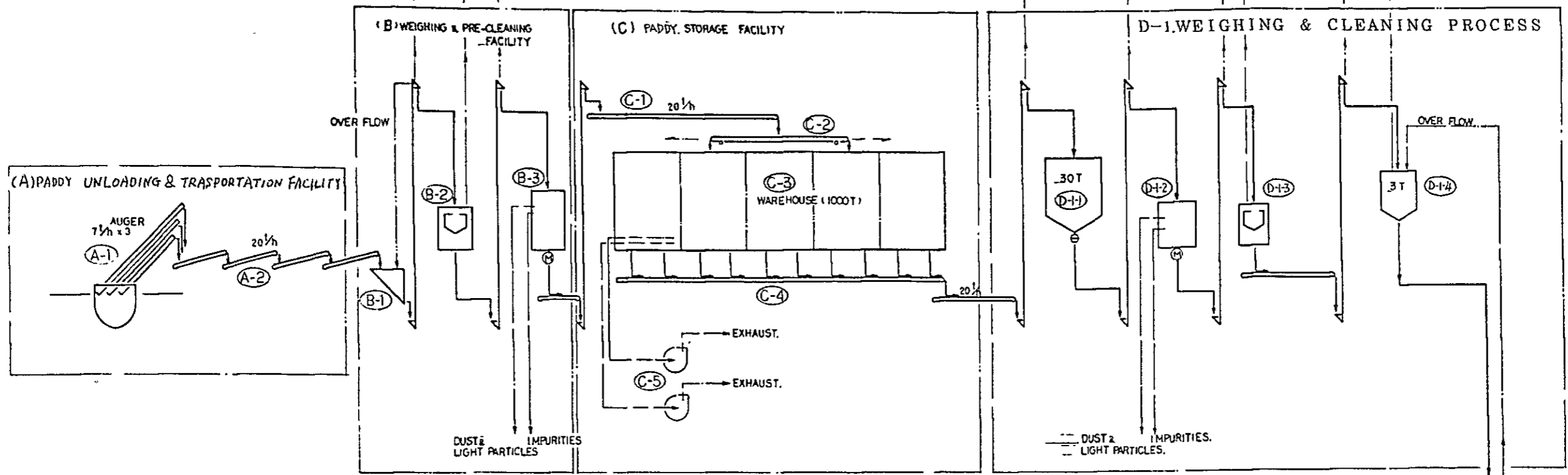

D-5) DUST COLLECTION SYSTEM

DUST

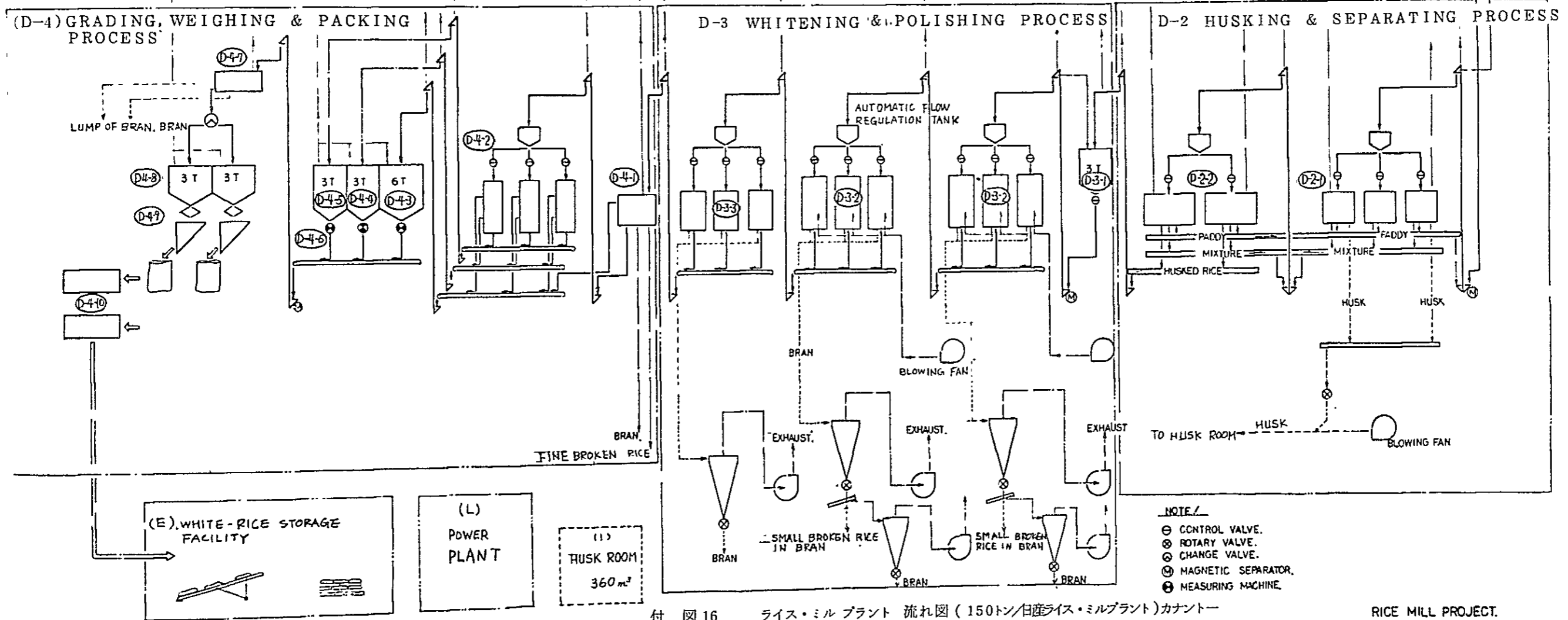

付 図 16
 Fig. 16

ライス・ミルプラント 流れ図 (150トン/日産ライス・ミルプラント) カナントー
 AN EXAMPLE OF FLOW CHART OF RICE MILL PLANT, KANAUNGTOE (150 TONS PER DAY RICE MILL PLANT)

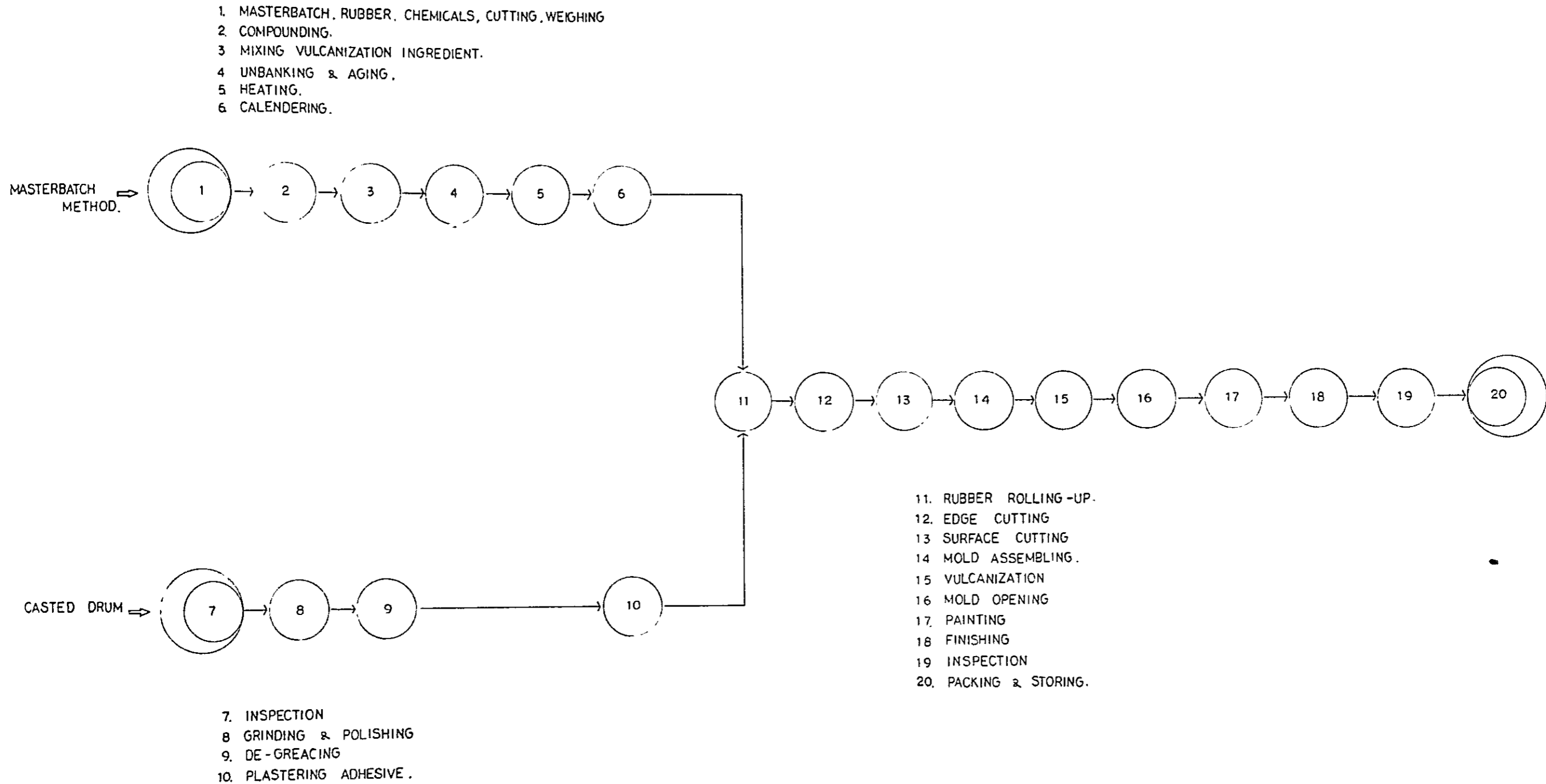

付 図 17
 Fig. 17

ゴムロール工場 流れ図 ラングーン
 AN EXAMPLE OF FLOW CHART OF RUBBER
 ROLL FACTORY, RANGOON

_____ RICE MILL PROJECT.

THE SOCIALIST REPUBLIC OF THE UNION OF BURMA.

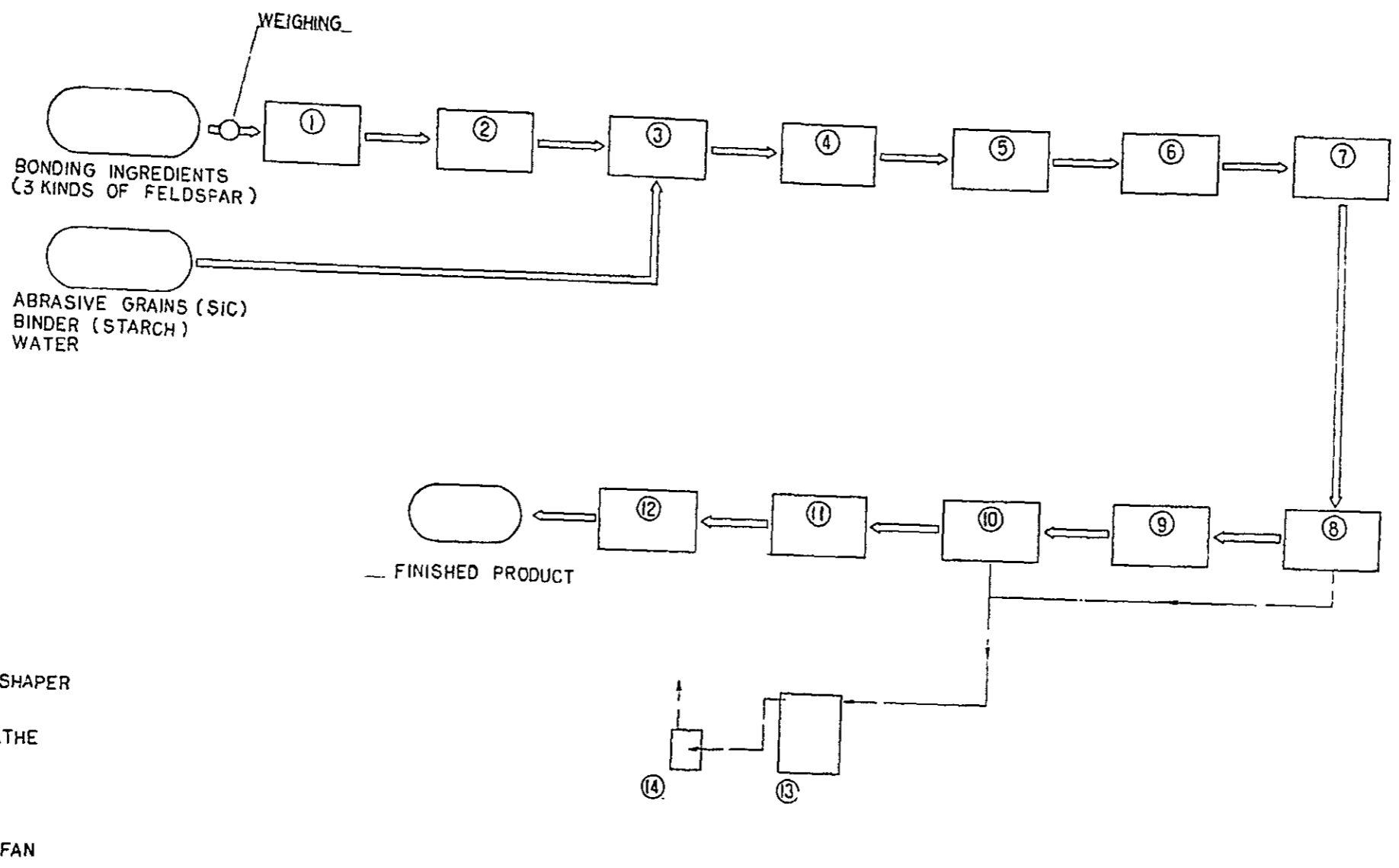

- ① AGITATER
- ② VIBRATING SIEVE
- ③ MIXER
- ④ BELT CONVEYOR
- ⑤ VIBRATING SIEVE
- ⑥ MOULDING
- ⑦ DRYING OVEN
- ⑧ ROLL PERIPHERAL SHAPER
- ⑨ KILN
- ⑩ ABRASIVE ROLL LATHE
- ⑪ BALANCER
- ⑫ HARDNESS
- ⑬ DUST COLLECTER
- ⑭ EXHAUST SUCTION FAN

付 図 18 研削ロール工場 流れ図 ラングーン
 Fig. 18 AN EXAMPLE OF FLOW CHART OF ABRASIVE ROLL FACTORY, RANGOON

RICE MILL PROJECT
 THE SOCIALIST REPUBLIC OF THE UNION OF BURMA
 RANGOON

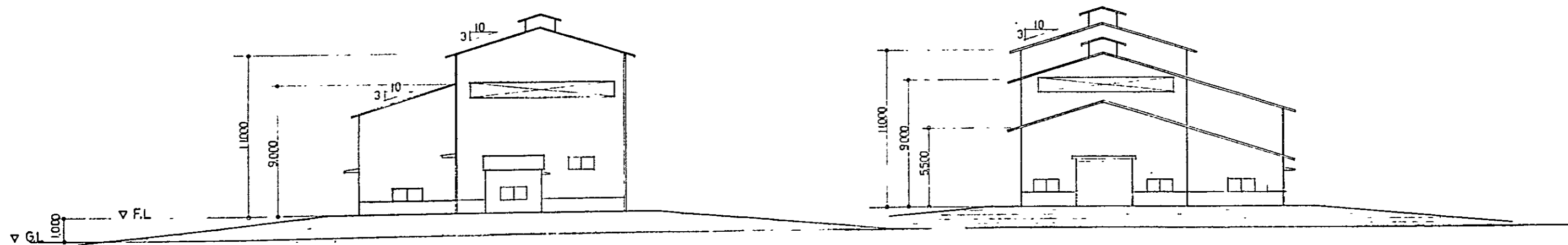
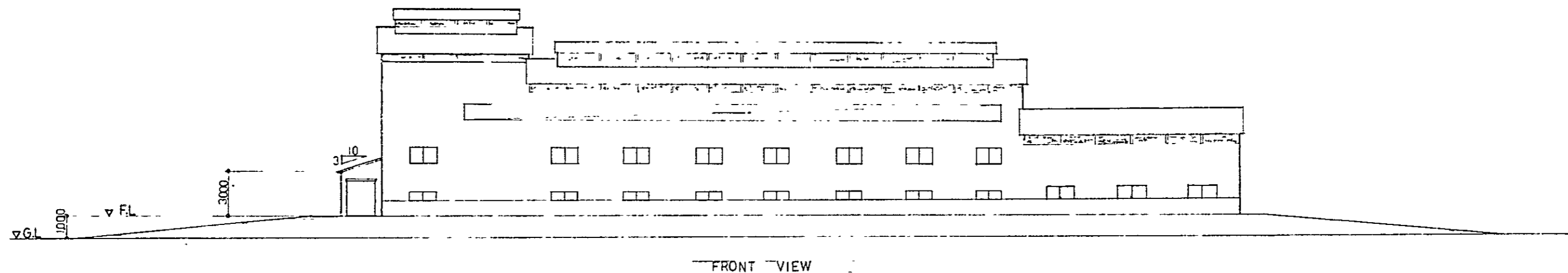
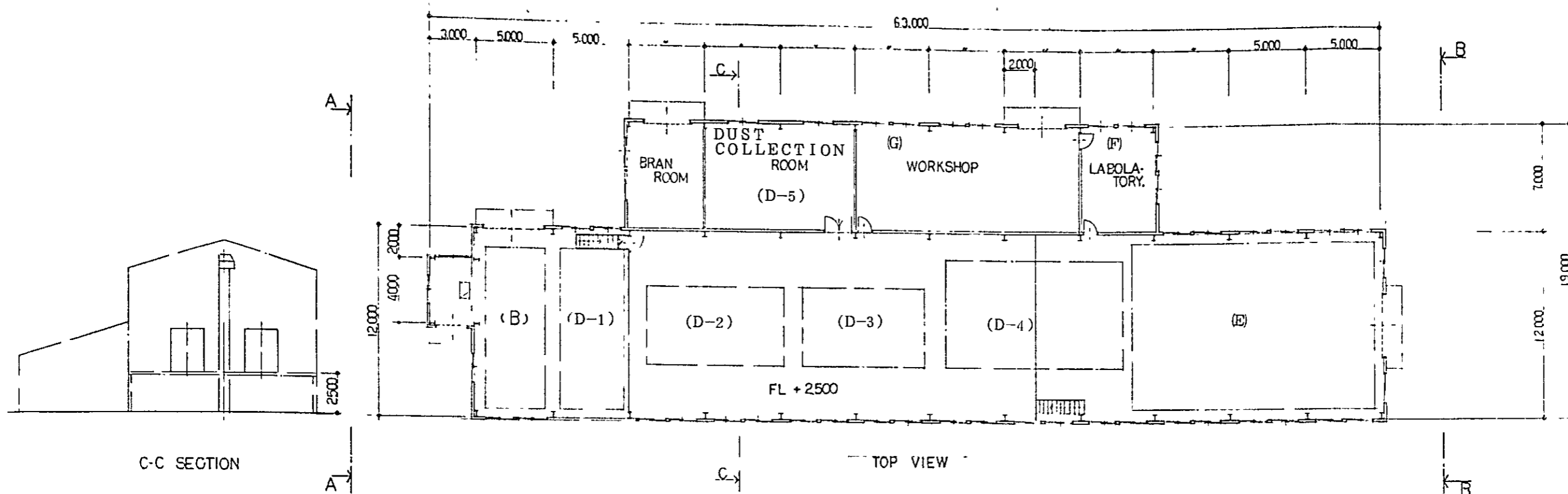

A - A VIEW 付 図 19

ライス・ミル建物 (150トン/日産ライス・ミル)
 バセイン, カナントー
 Fig. 19 BUILDING FOR RICE MILL PLANT BASSEIN &
 KANAUNGTOE (150 TONS PER DAY RICE MILL)

B - B VIEW

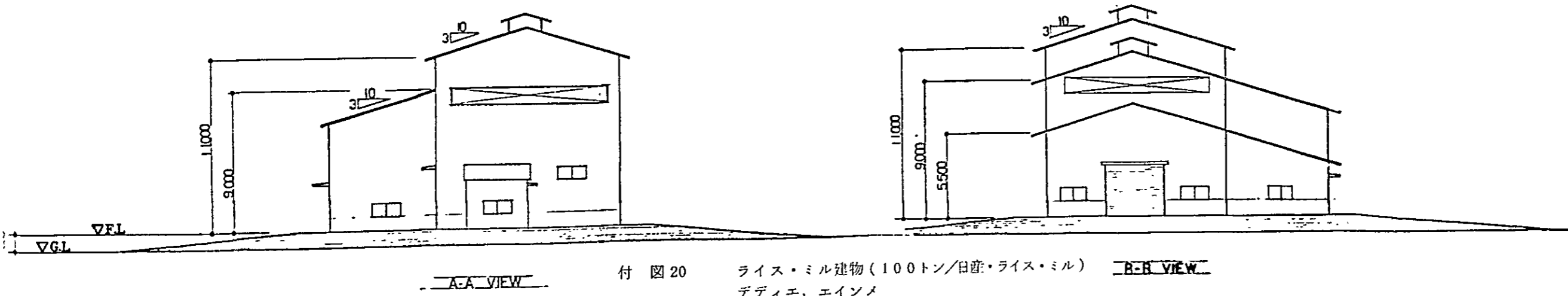
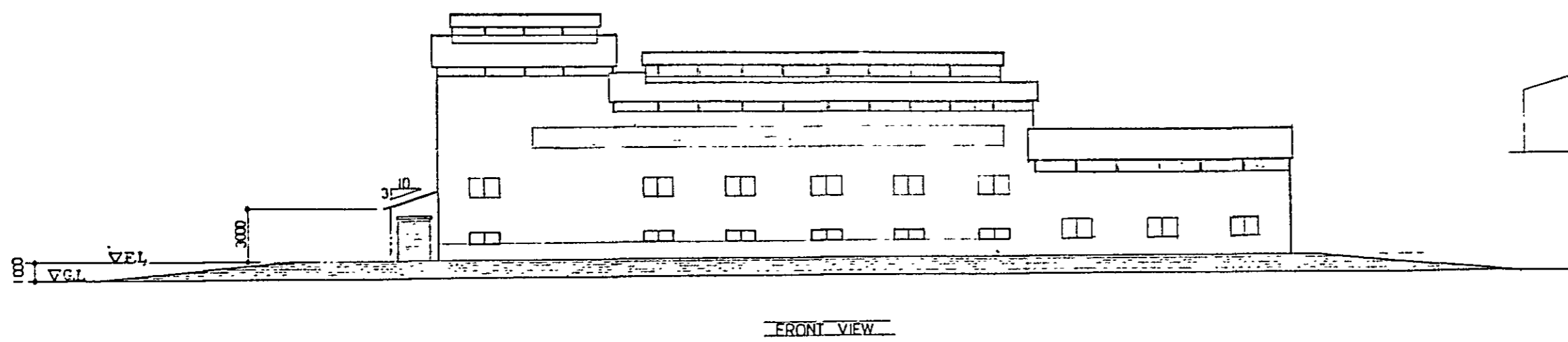
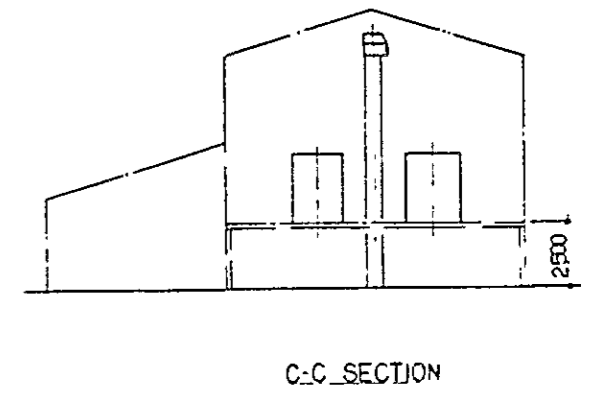
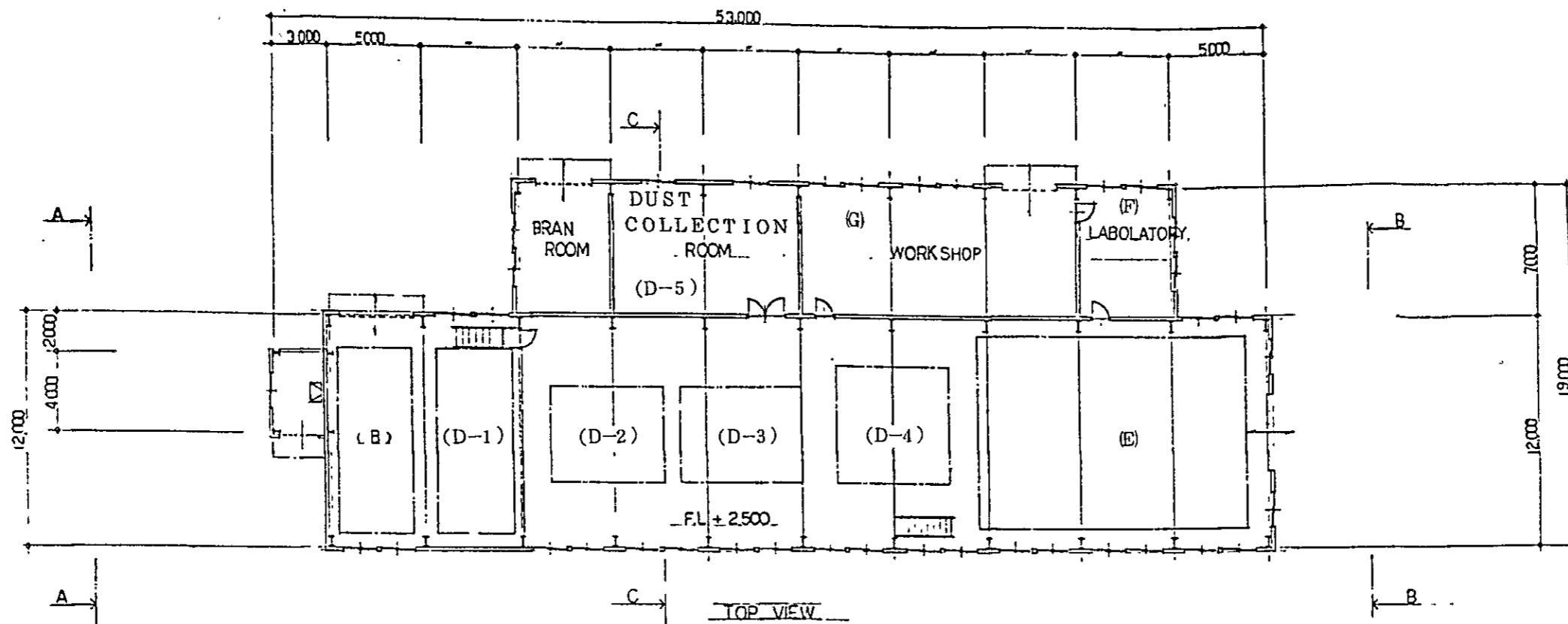

付 図 20 ライス・ミル建物 (100トン/日産・ライス・ミル)
 デディエ, エインメ
 Fig. 20 BUILDING FOR RICE MILL PLANT, DEDAYE & EINME
 (100 TONS PER DAY RICE MILL)

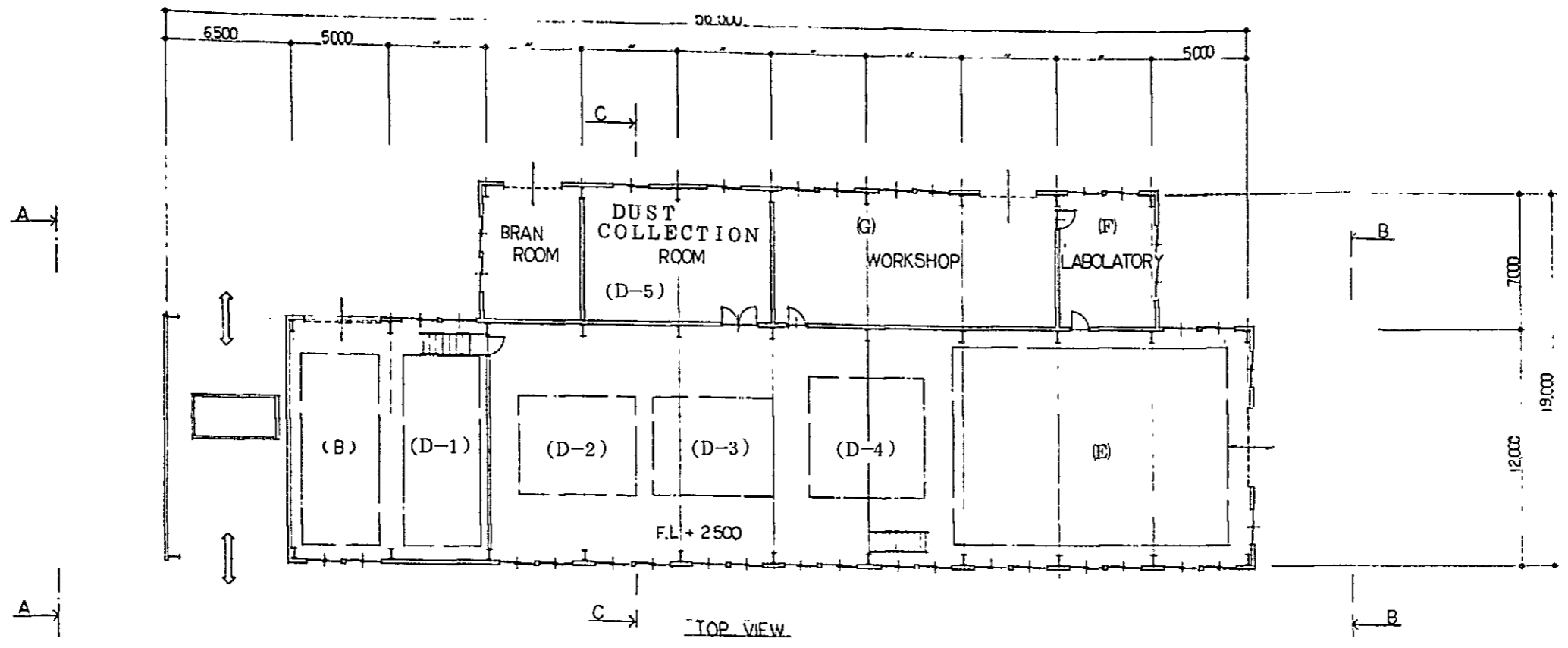

TOP VIEW

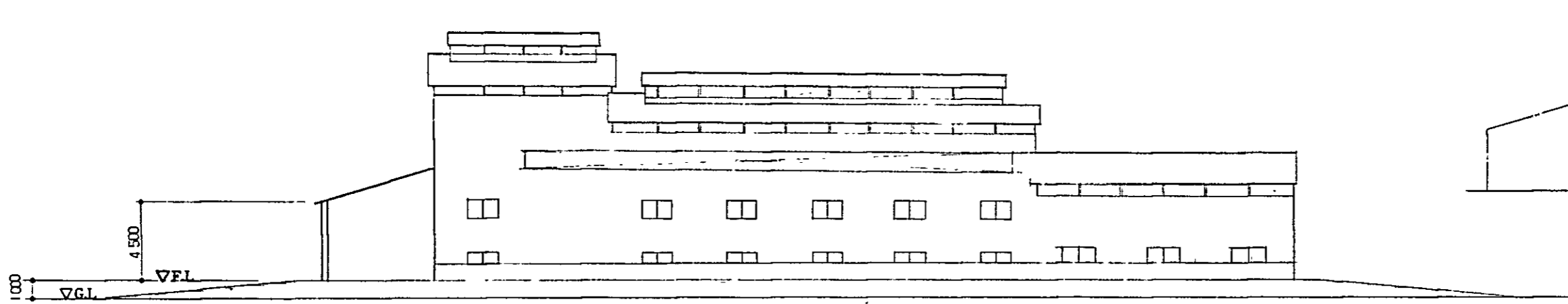

FRONT VIEW

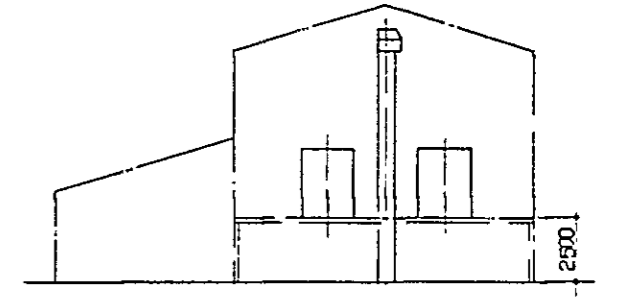

C-C SECTION

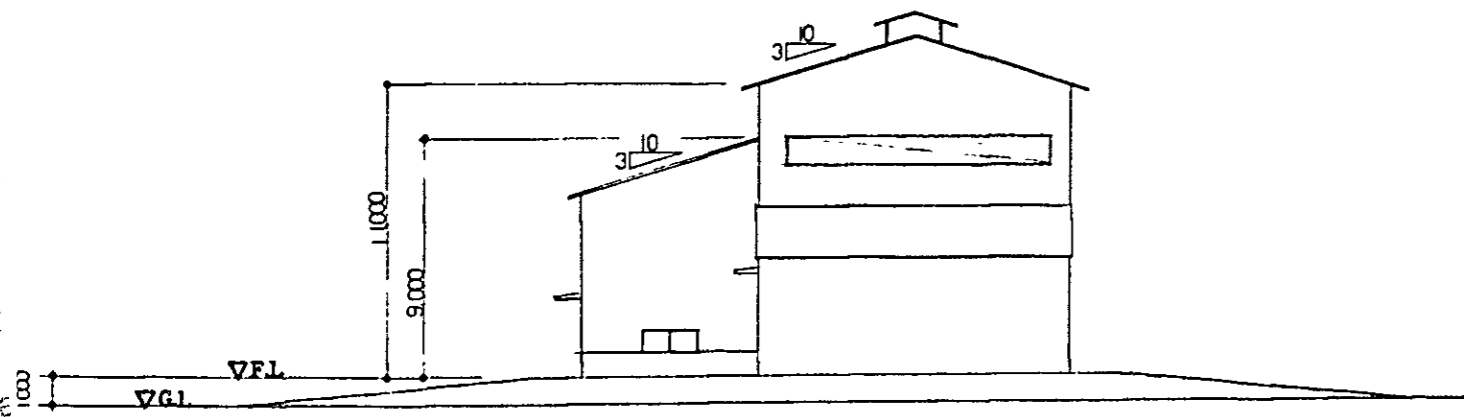

A-A VIEW

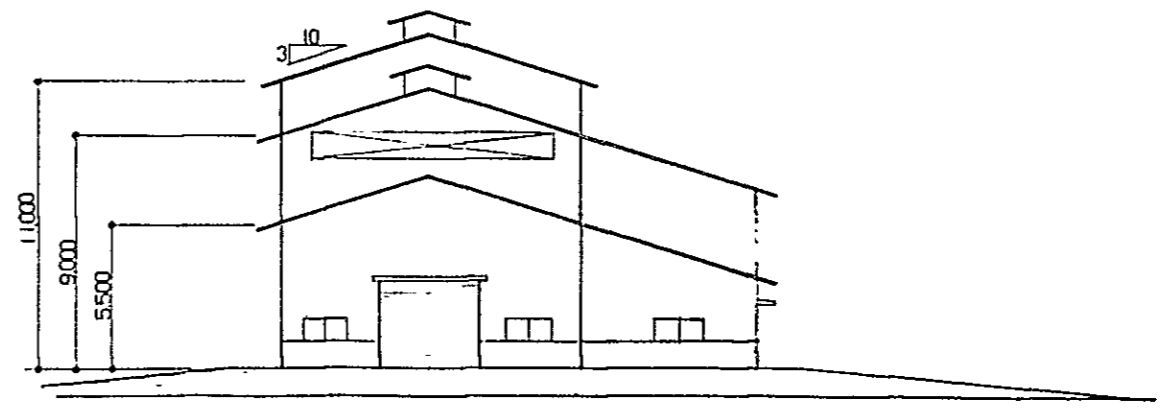

B-B VIEW

付 図 21 ライス・ミル建物 (100トン/日産ライス・ミル)
 レグー, ダニユビュー, カワ, チャウタガ
 Fig. 21 BUILDING FOR RICE MILL, HLEGU, DANUBYU,
 KAWA, & KYAUKTAGA (100 TONS PER DAY RICE MILL)

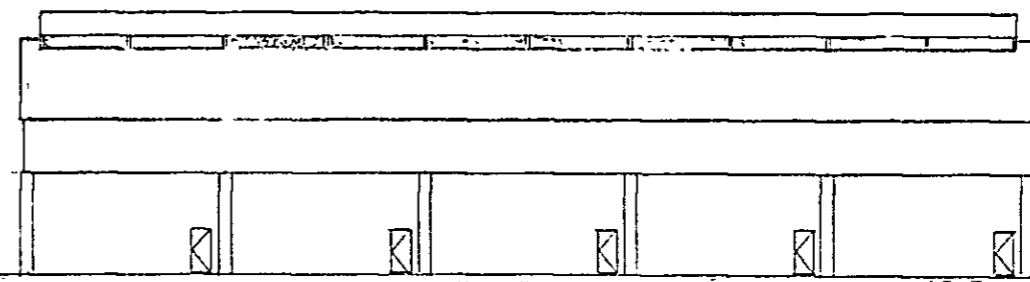
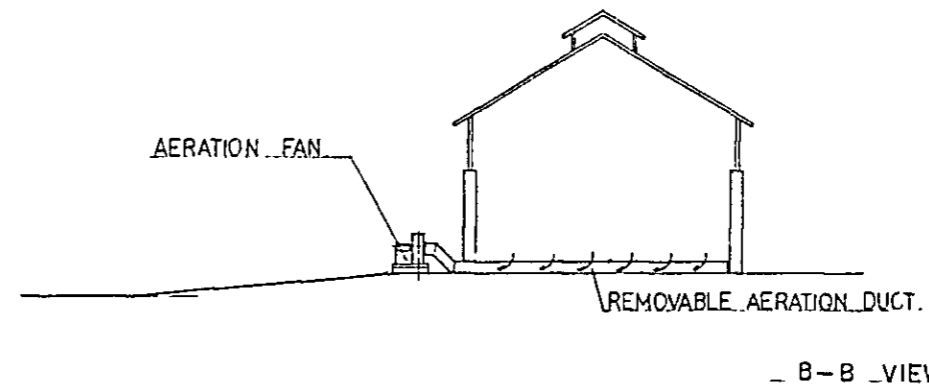
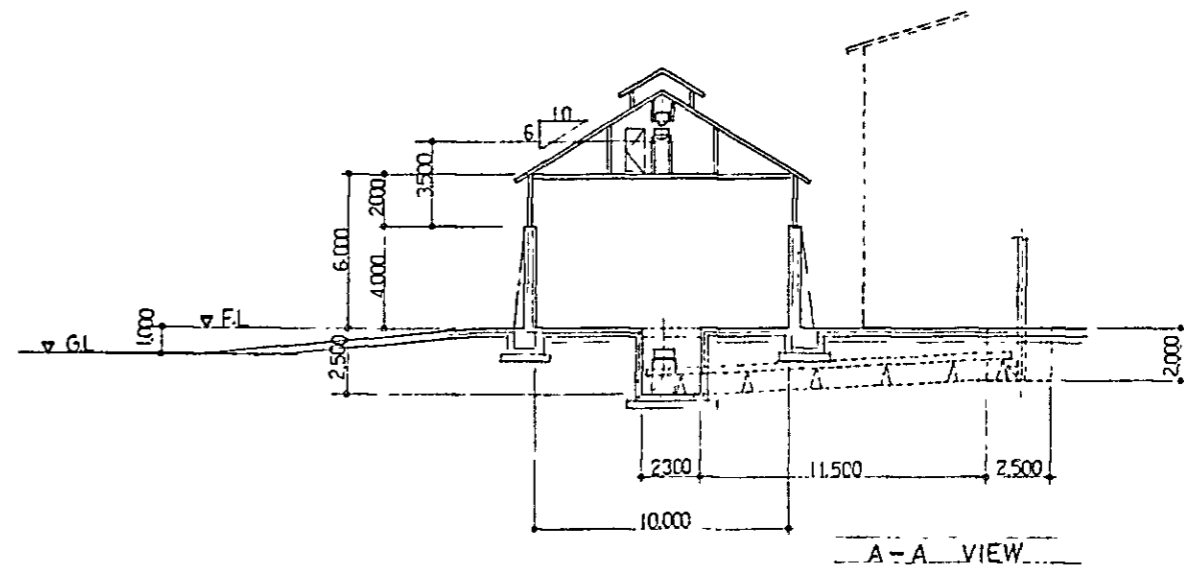
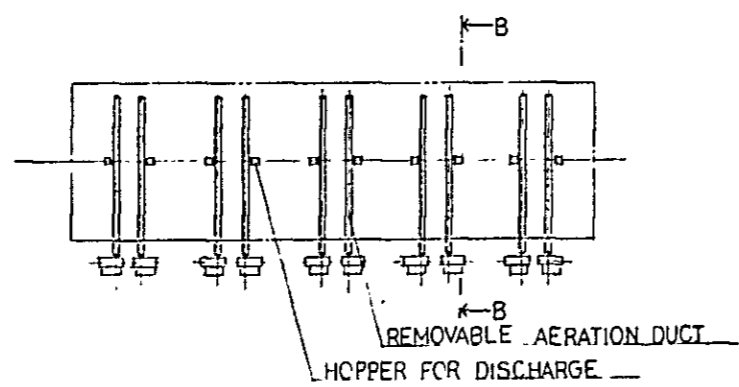
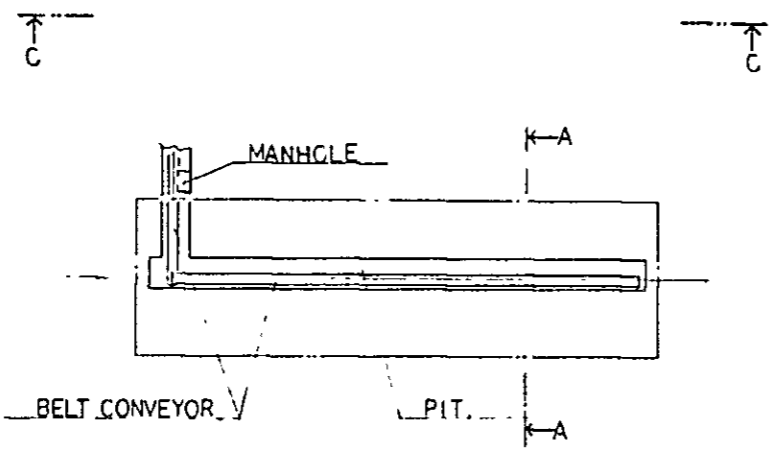
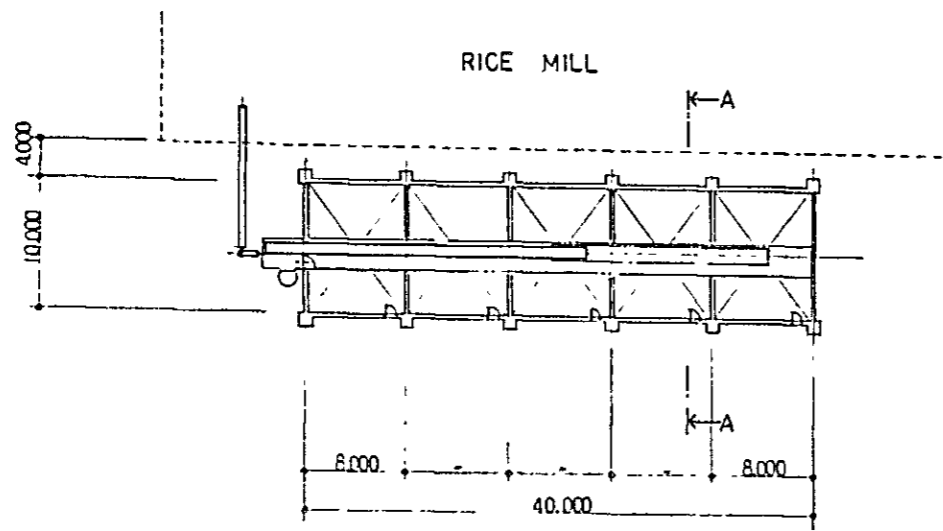

付 図 22

初 倉 庫 1,000T 予 定 地 8ヶ 所

C-C VIEW

Fig. 22

PADDY STORAGE 1,000T AT 8 PROJECT SITES

RICE MILL PROJECT

THE SOCIALIST REPUBLIC OF THE UNION OF BURMA,
 BASSEIN, KANAUNGTOE, DEDAYE, HLEGU, DANUBYU, KAWA, EINME, KYAUKTAGA

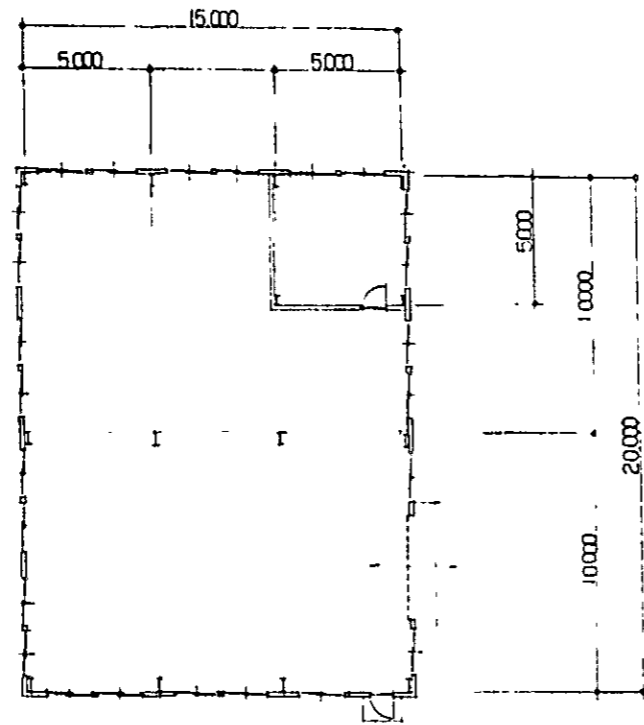

TOP VIEW

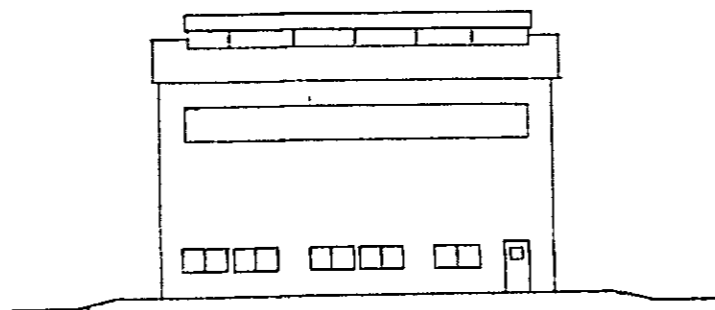

FRONT VIEW

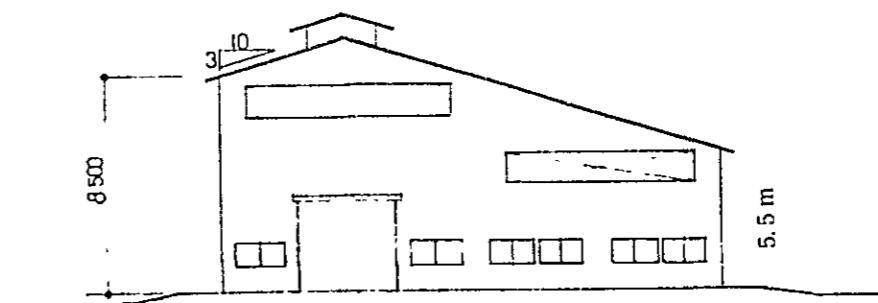

SIDE VIEW

付 図 23 発電室建物 カナントー, デディエ
Fig. 23 BUILDING FOR POWER PLANT
KANAUNGTOE & DEDAYE

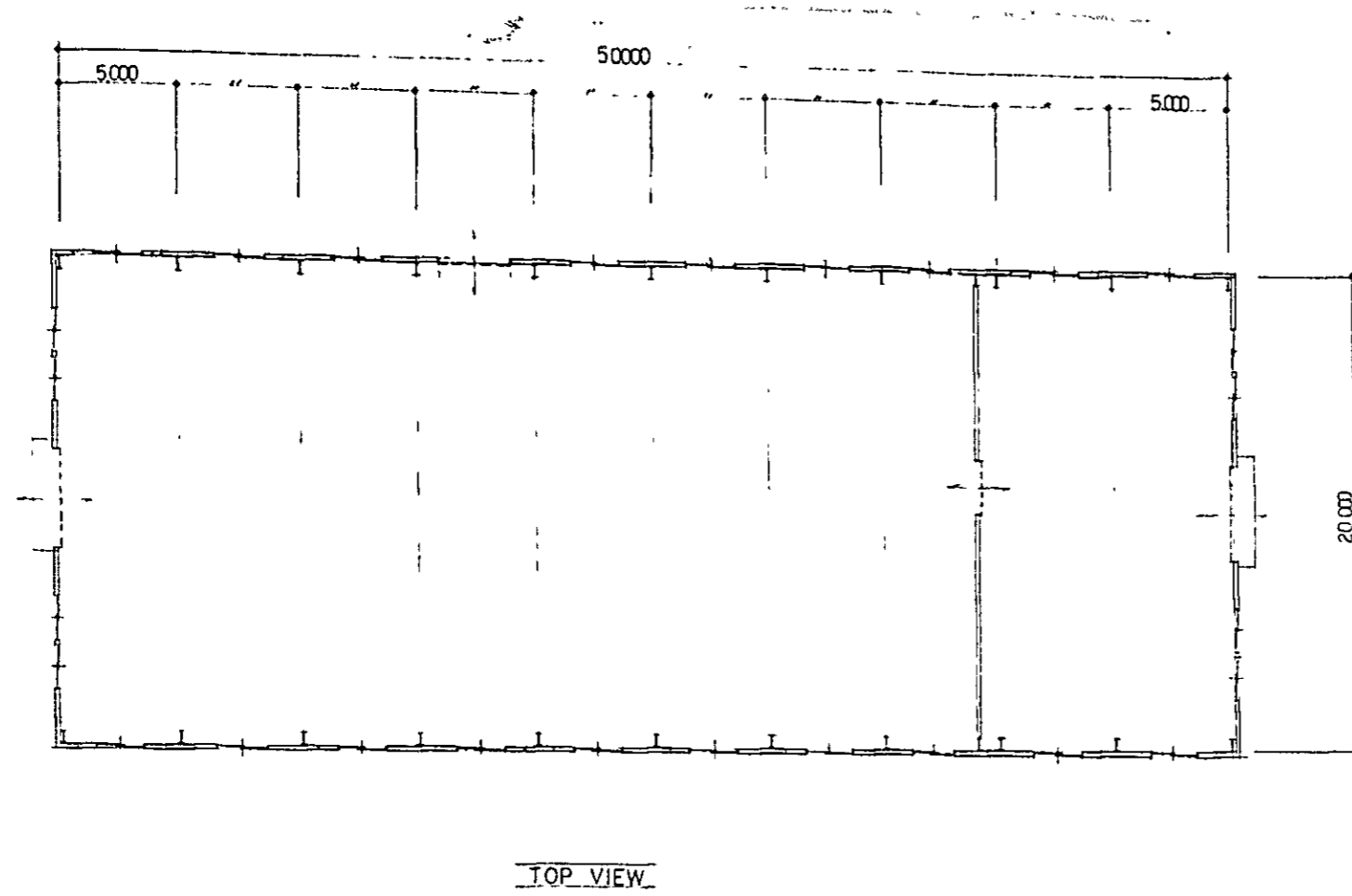

TOP VIEW

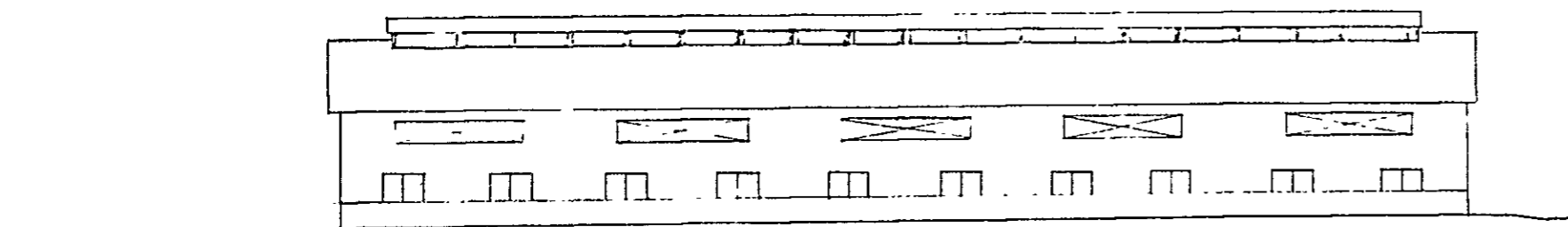
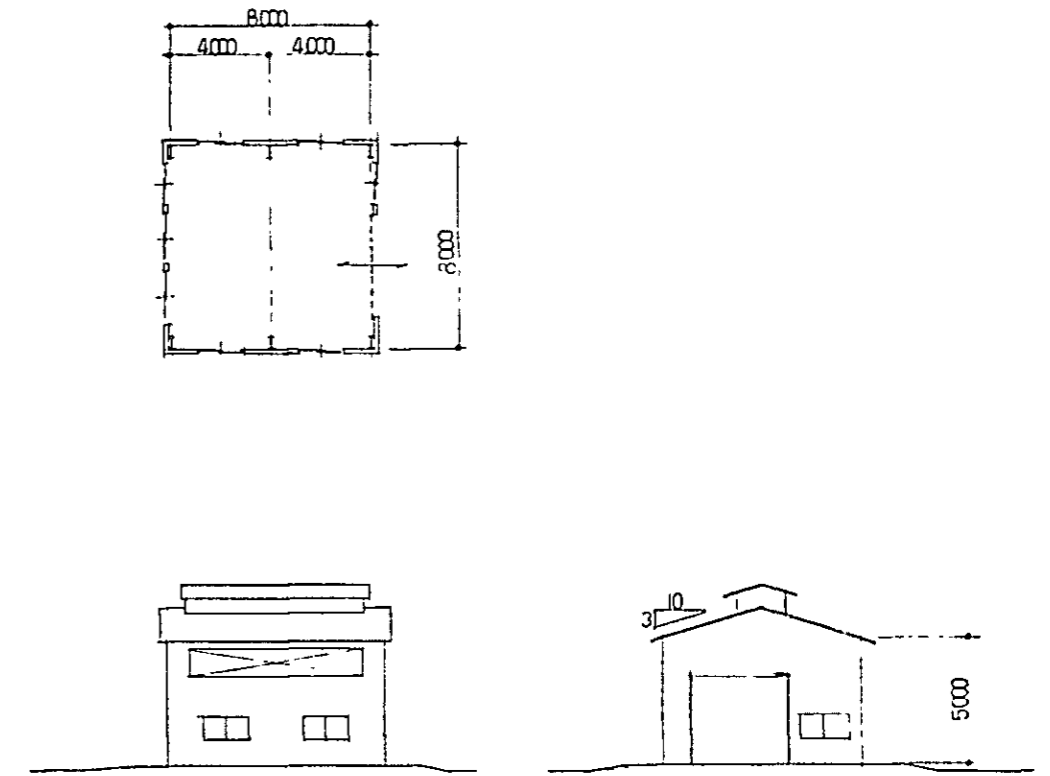

FRONT VIEW

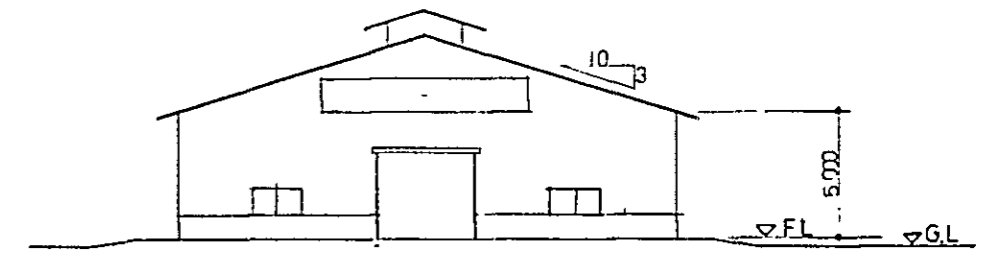

SIDE VIEW

付 図 24 ゴムロール工場建物 ラングーン
 Fig. 24 BUILDING FOR RUBBER ROLL FACTORY, RANGOON

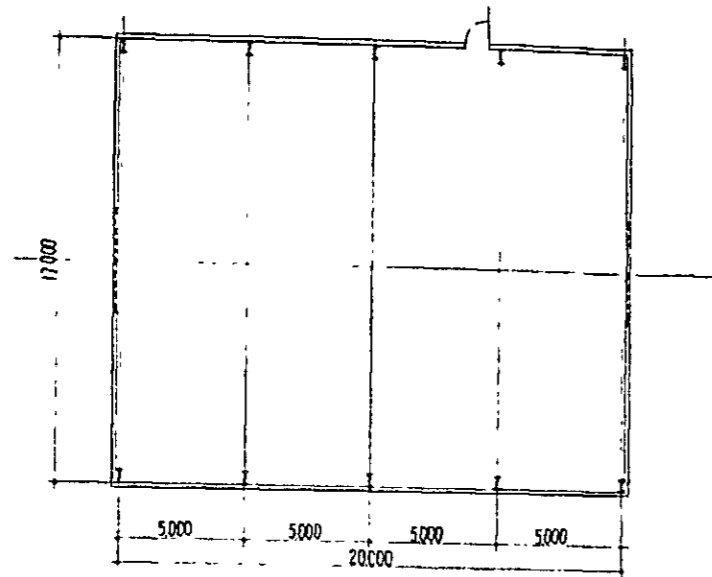

TOP VIEW

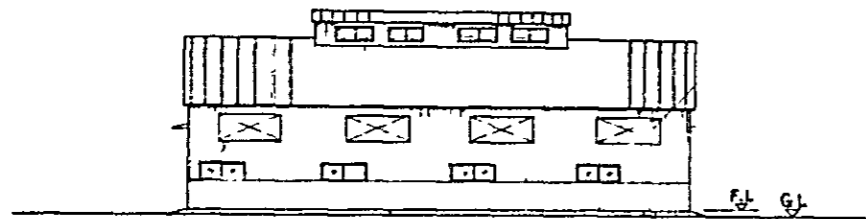

FRONT VIEW

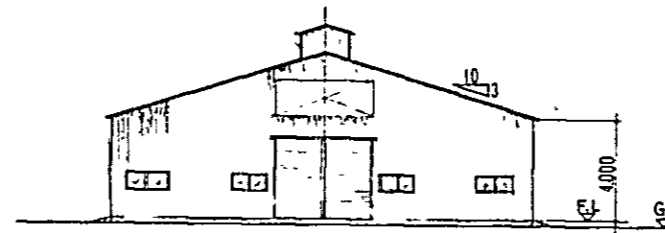

SIDE VIEW

RICE MILL PROJECT
 THE SOCIALIST REPUBLIC OF THE UNION OF BURMA
 RANGOON

付 図 25 研削ロール工場建物 ランダーン
 Fig. 25 BUILDING FOR ABRASIVE ROLL FACTORY, RANGOON

付 図 26 荷役用 ベルトコンベアー バセイン, カナント, デディエ, エインメ

Fig. 26 UNLOADING & TRANSPORTATION FACILITY,
BASSEIN, KANAUNGTOE, DEDAYE & EINME

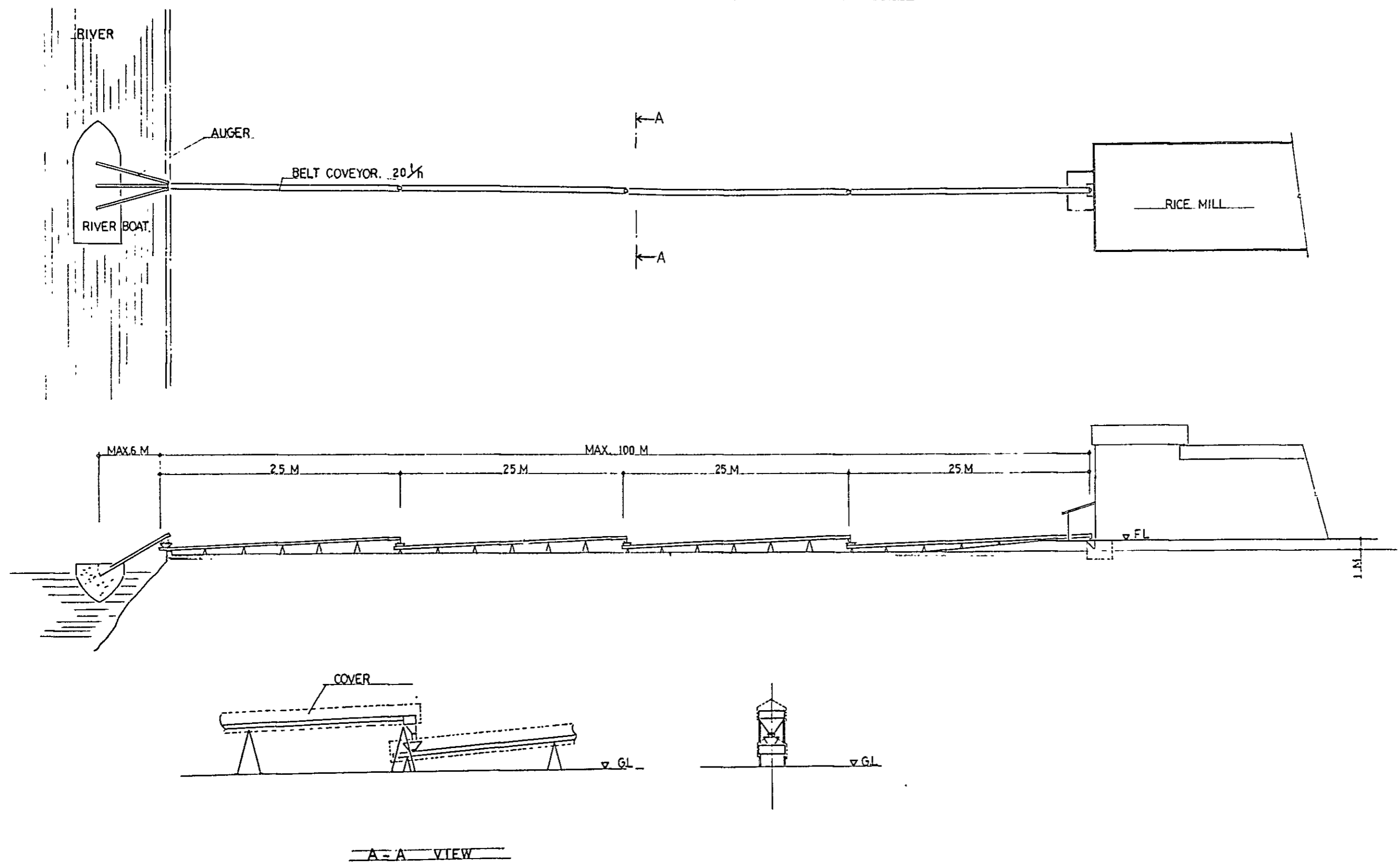

— RICE MILL PROJECT.

— THE SOCIALIST REPUBLIC OF THE UNION OF BURMA
BASSEIN, KANAUNGTOE, DEDAYE, EINME

1
2
3
4
5

6

7

8

9

10

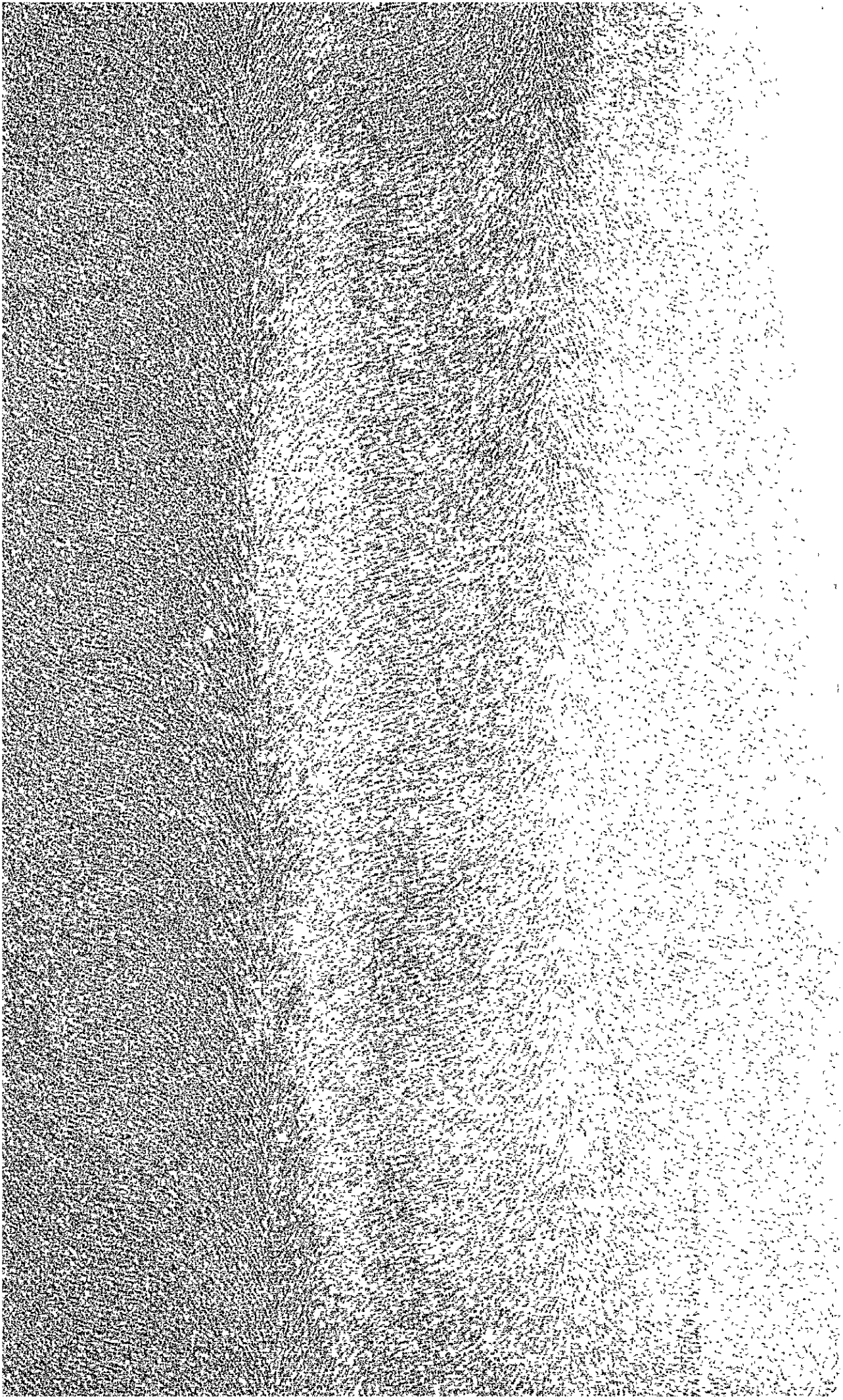

JICA