

ナウル國政府行政組織圖

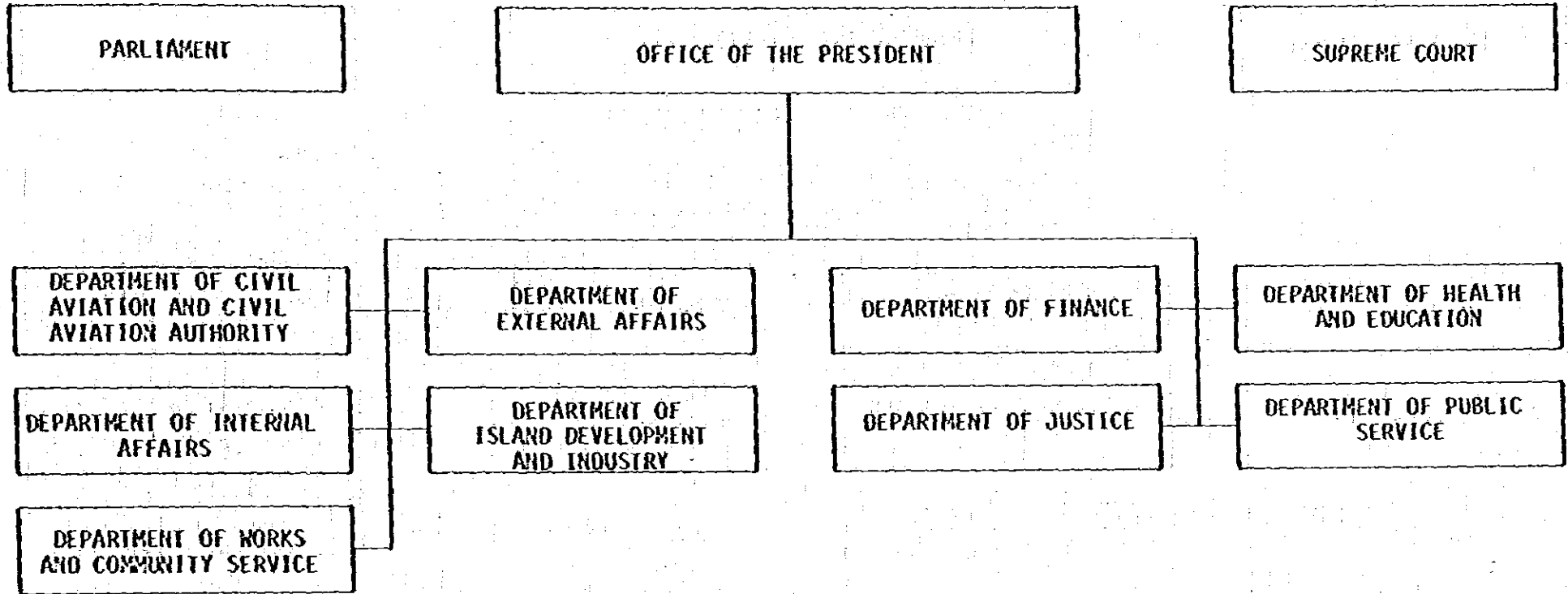

ナ  
ウ  
ル

行  
政  
組  
織

パ  
プ  
ア  
・  
ニ  
ュ  
ー  
ギ  
ニ  
ア

NATIONAL PARLIAMENT

OFFICE OF THE GOVERNOR-GENERAL

SUPREME COURT

DEPARTMENT OF THE PRIME MINISTER

OFFICE OF THE DEPUTY PRIME MINISTER AND  
DEPARTMENT OF TRANSPORT AND CIVIL AVIATION

OFFICE OF  
INFORMATION

OFFICE OF NATIONAL  
PLANNING AND  
DEVELOPMENT

DEPARTMENT OF COMMERCE  
AND INDUSTRY

DEPARTMENT OF  
DECENTRALIZATION

DEPARTMENT OF DEFENCE

DEPARTMENT OF EDUCATION

DEPARTMENT OF FINANCE

OFFICE OF HOME AFFAIRS

DEPARTMENT OF HEALTH

DEPARTMENT OF JUSTICE  
CORRECTIVE INSTITUTIONS  
SERVICE

DEPARTMENT OF PRIMARY  
INDUSTRY

DEPARTMENT OF LANDS,  
NATIONAL MAPPING AND  
ENVIRONMENT

DEPARTMENT OF MINERALS  
AND ENERGY

DEPARTMENT OF POLICE

OFFICE OF FORESTS

DEPARTMENT OF PUBLIC  
UTILITIES

DEPARTMENT OF THE  
PUBLIC SERVICES  
COMMISSION

DEPARTMENT OF URBAN  
DEVELOPMENT

DEPARTMENT OF LABOUR  
AND EMPLOYMENT

DEPARTMENT OF WORKS  
AND SUPPLY

OFFICE OF SCIENCE,  
CULTURE AND TOURISM

行  
政  
組  
織

STRUCTURE OF THE  
PAPUA NEW GUINEA GOVERNMENT

LEGISLATIVE

EXECUTIVE

JUDICIAL

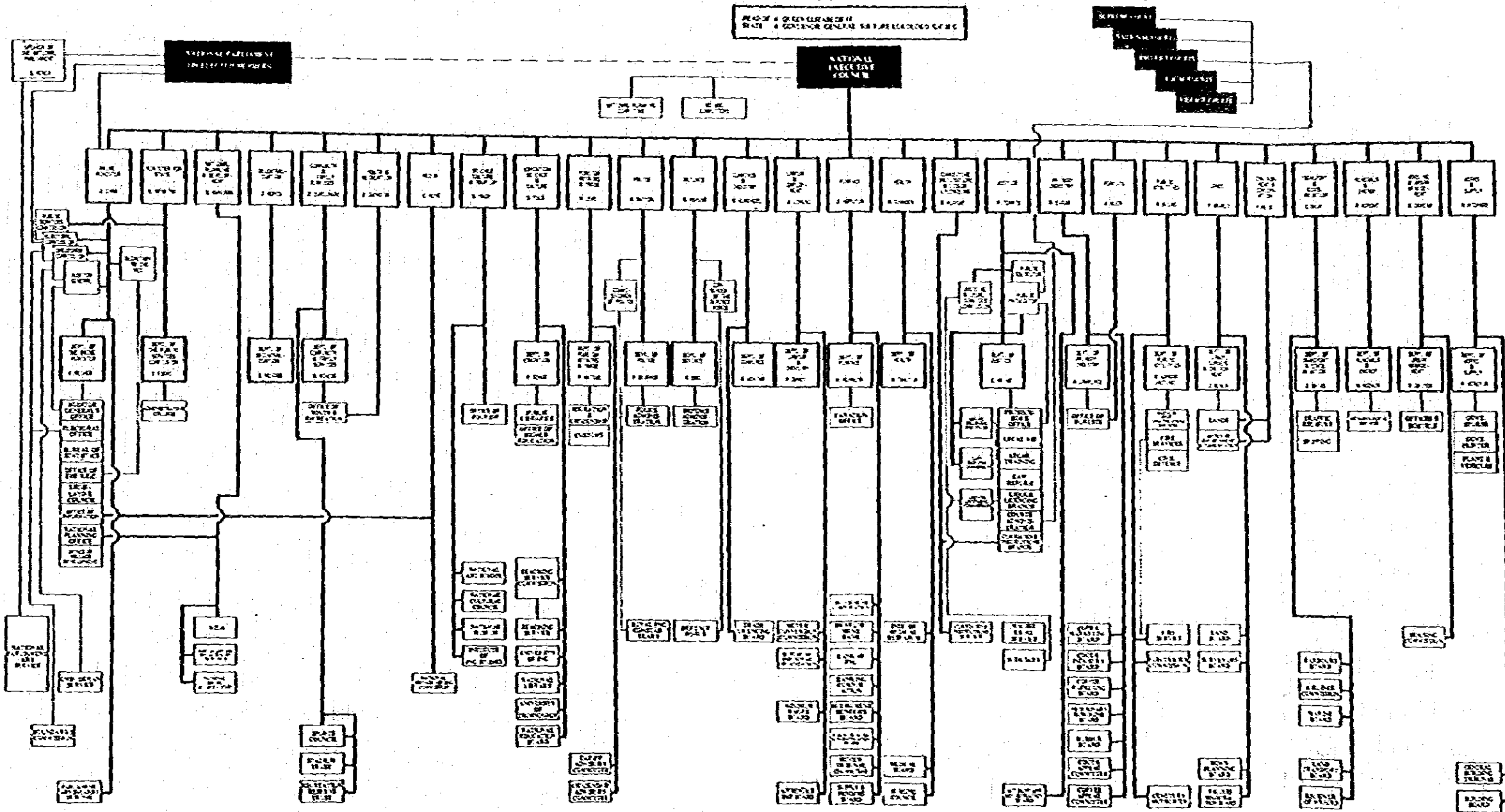

パプア・ニューギニア

行政組織(詳細図)

(NATIONAL PARLIAMENT)

ソロモン諸島政府行政組織図

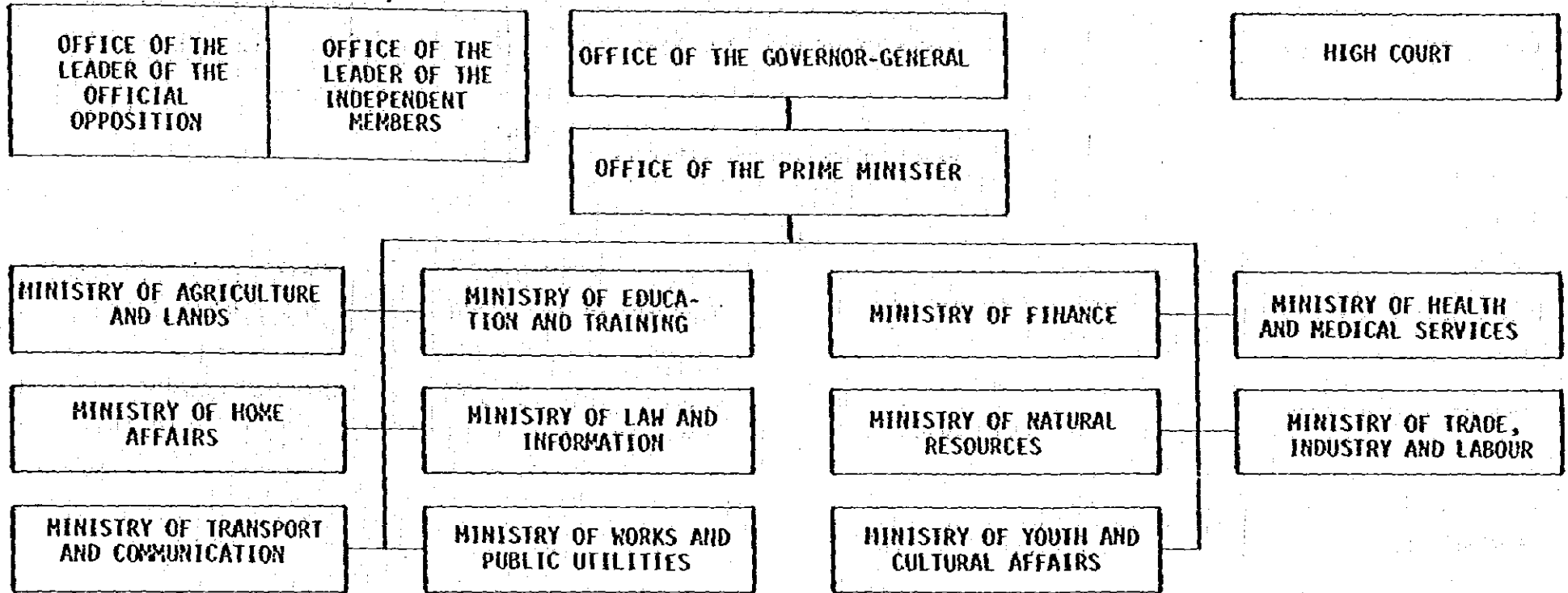

ソ  
ロ  
モ  
ン  
諸  
島

行  
政  
組  
織

トンガ国政府行政組織図

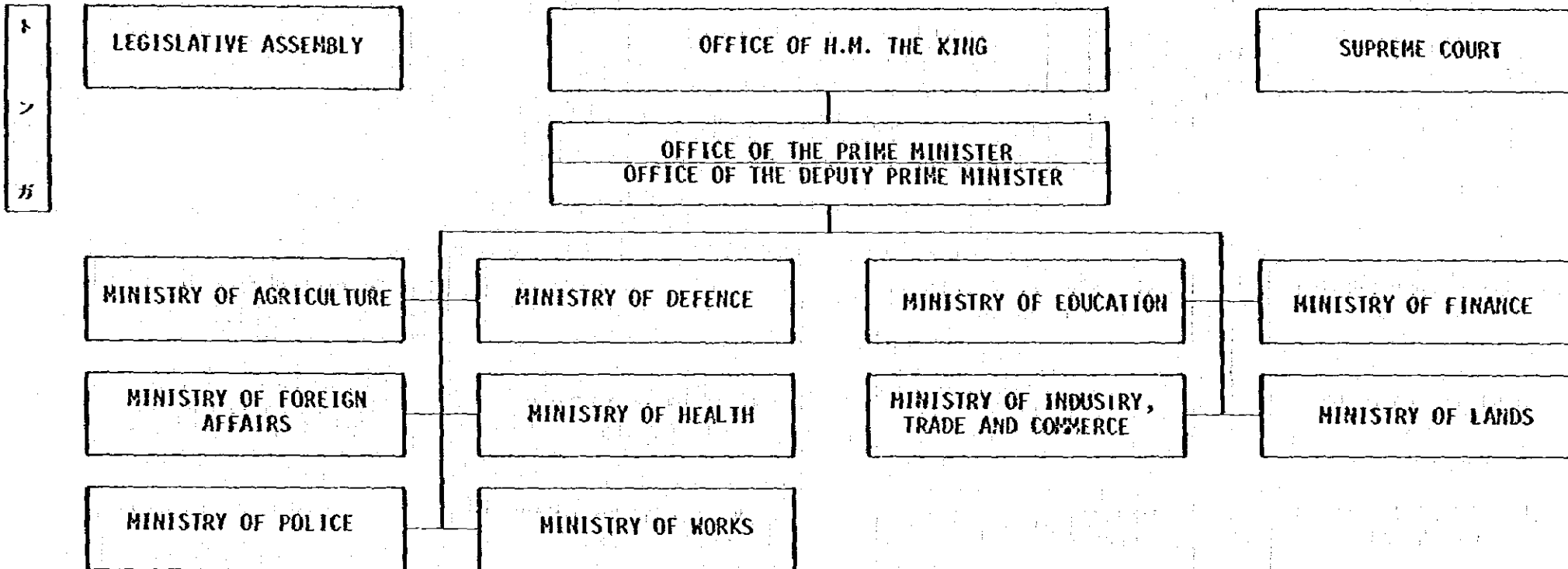

行  
政  
組  
織

トウバル国政府行政組織図

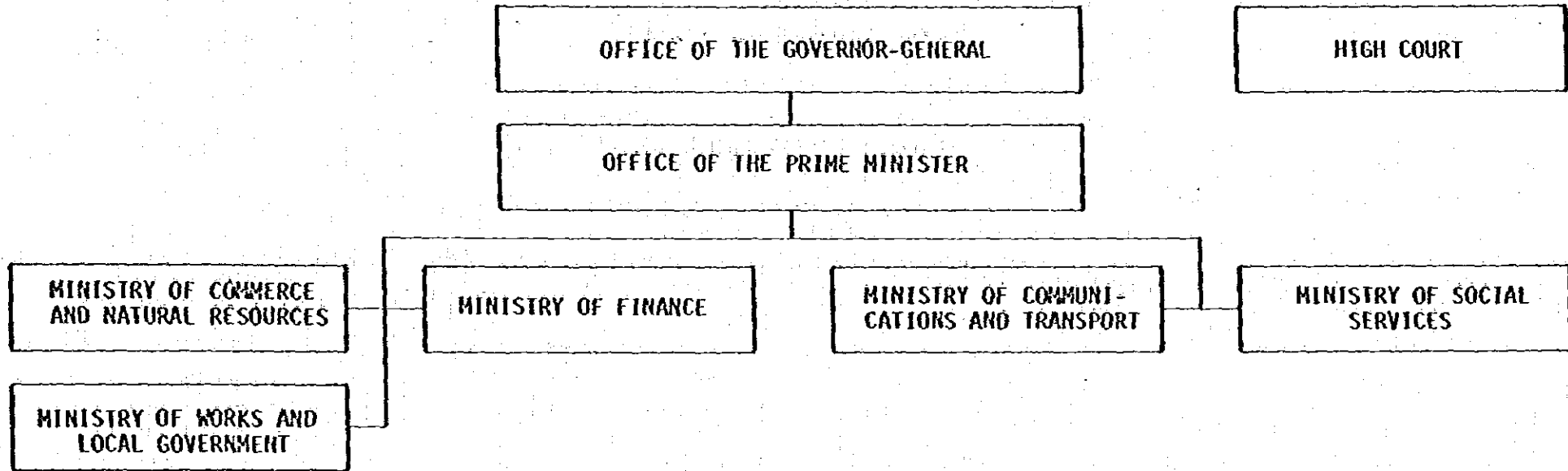

ト  
ウ  
バ  
ル

行  
政  
組  
織

西サモア国政府行政組織図

西  
サ  
モ  
ア

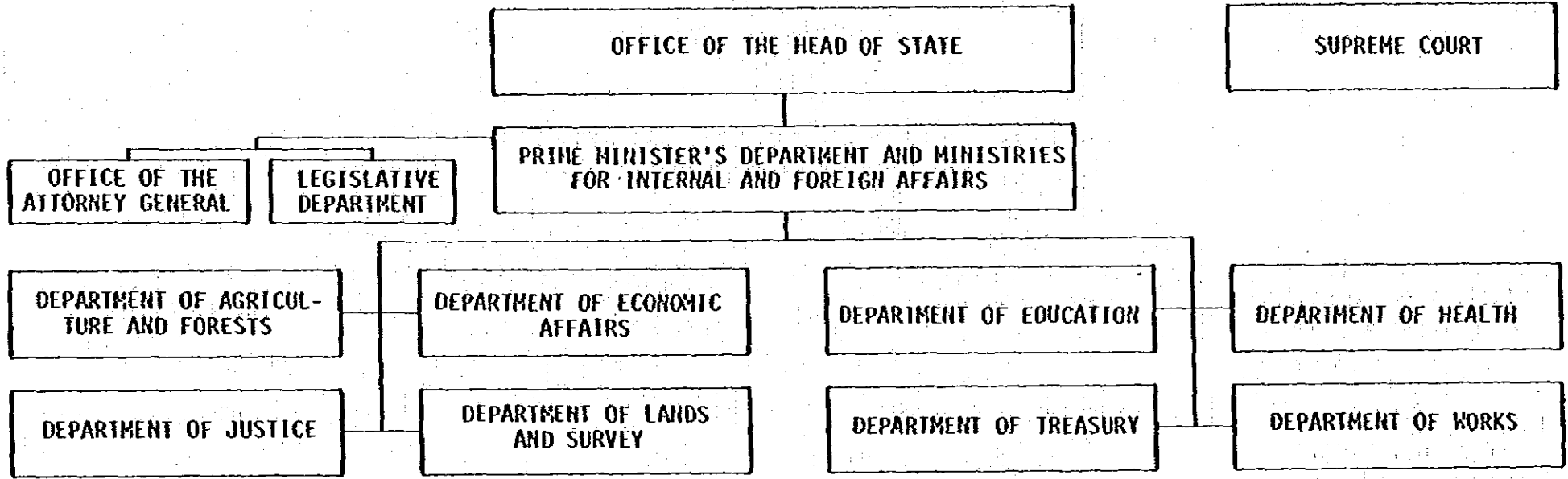

行  
政  
組  
織

# ヨーロッパ地域



サイプラス国政府行政組織図

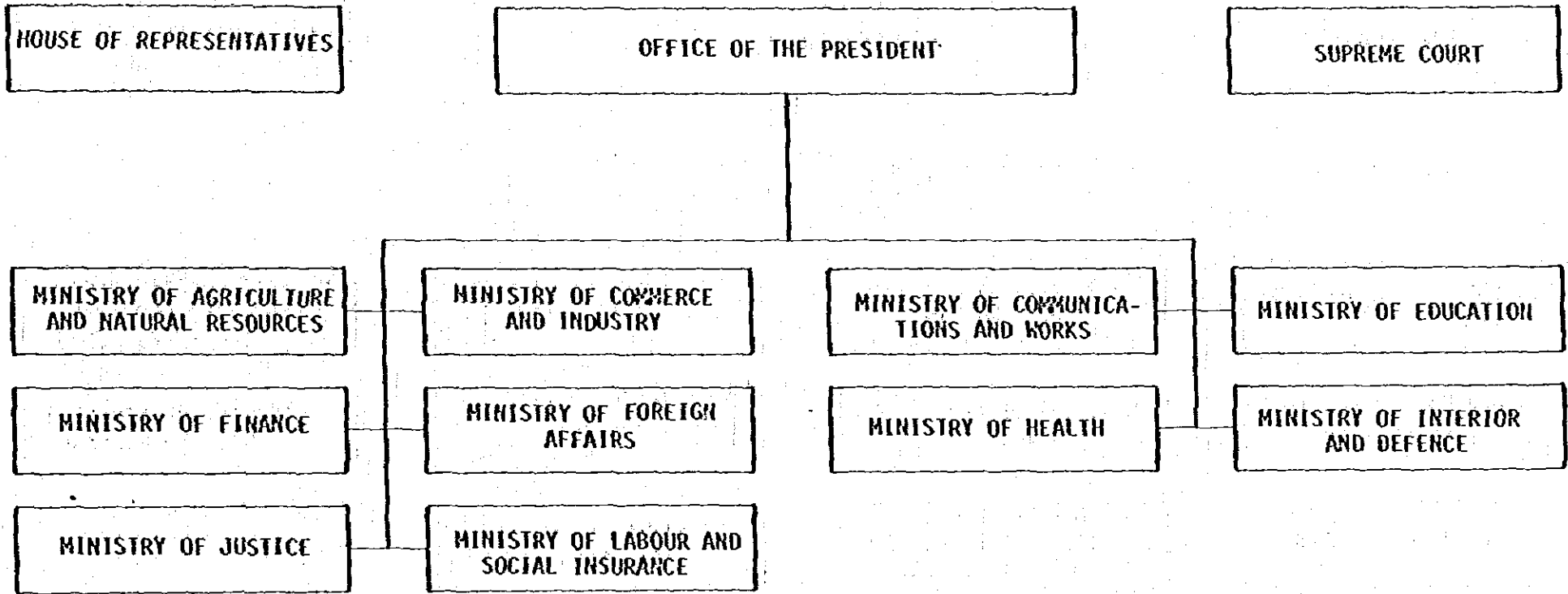

サイ  
プ  
ラ  
ス

行  
政  
組  
織

マ  
ル  
タ

HOUSE OF REPRESENTATIVES

OFFICE OF THE PRESIDENT

CONSTITUTIONAL COURT AND COURT OF APPEAL

OFFICE OF THE PRIME MINISTER AND MINISTER OF FOREIGN AFFAIRS AND INTERIOR

MINISTRY OF AGRICULTURE AND FISHERIES

MINISTRY OF DEVELOPMENT, ENERGY, PORT AND TELECOMMUNICATIONS

MINISTRY OF EDUCATION

MINISTRY OF FINANCE, CUSTOMS AND PEOPLE'S FINANCIAL INVESTMENTS

MINISTRY OF FOREIGN AFFAIRS AND INTERIOR

MINISTRY OF HEALTH AND ENVIRONMENT

MINISTRY OF JUSTICE, LANDS, HOUSING AND PARLIAMENTARY AFFAIRS

MINISTRY OF LABOUR, CULTURE AND WELFARE

MINISTRY OF TOURISM

MINISTRY OF TRADE, INDUSTRY, PARASTATAL AND PEOPLE'S INDUSTRIES

MINISTRY OF WORKS AND SPORT

行  
政  
組  
織



JICA