

夕
イ

交
通
省
(3)

商 務 省 組 織 圖

夕
1

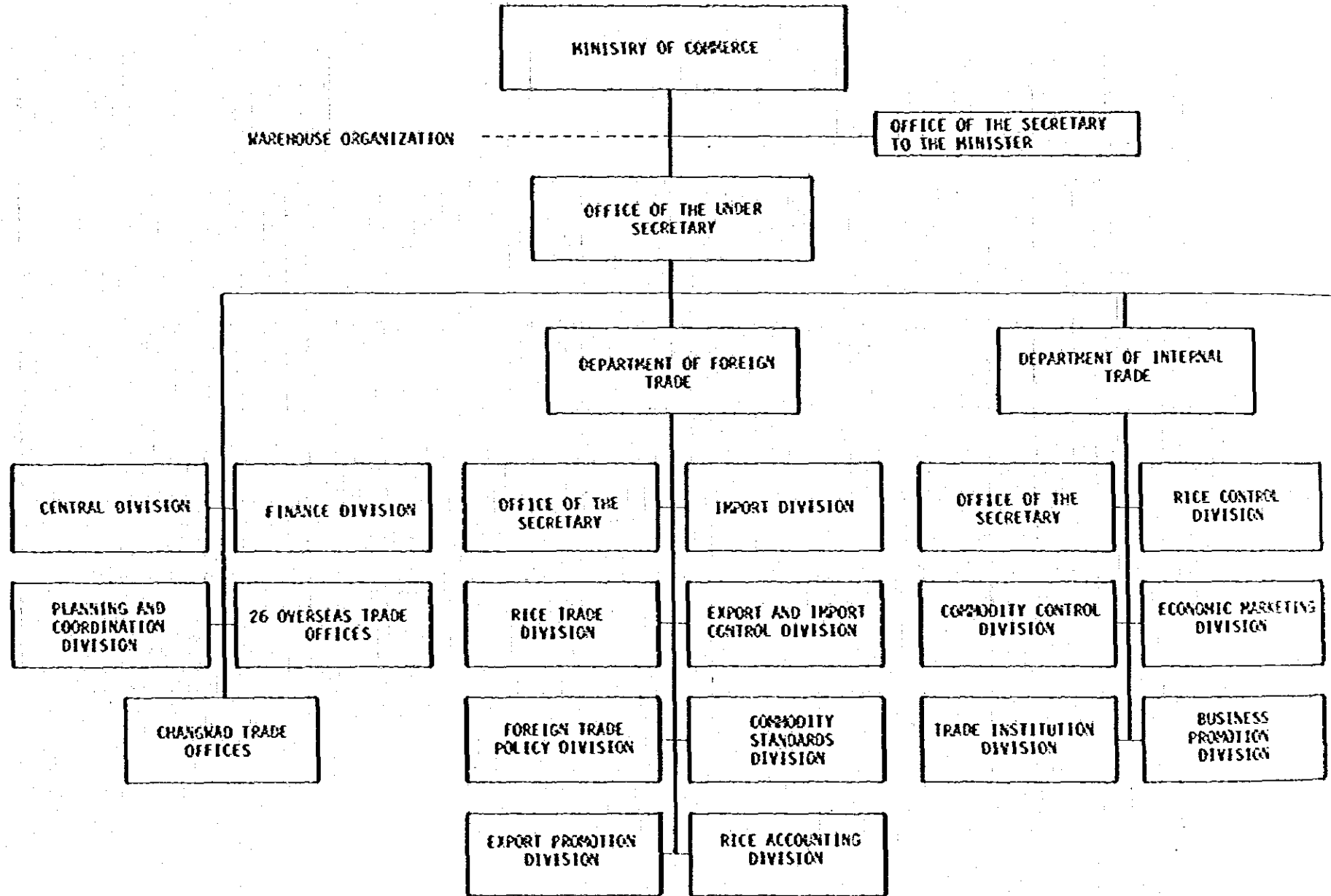

商
務
省
(1)

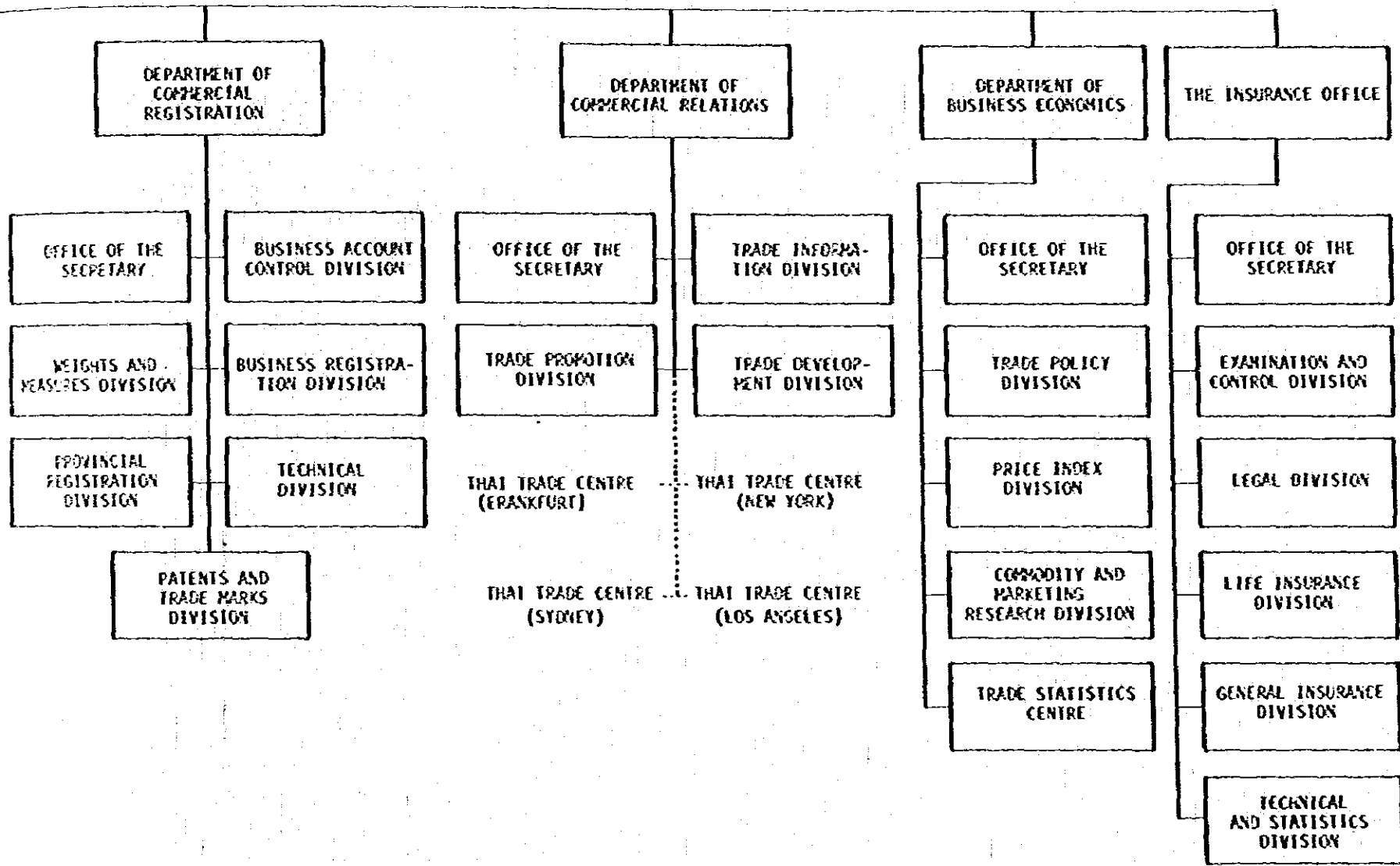

内務省組織図

夕
イ

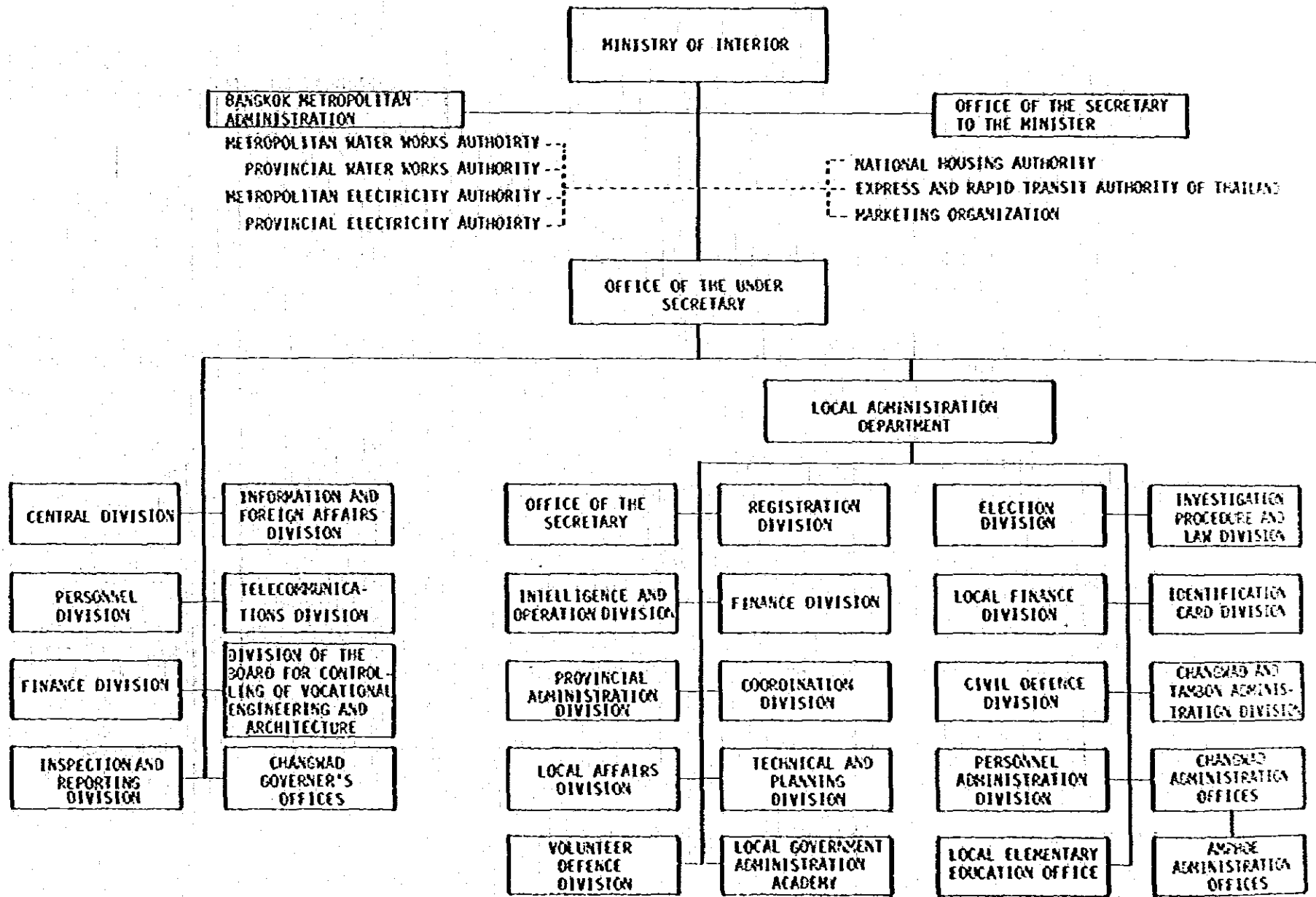

内務省
(1)

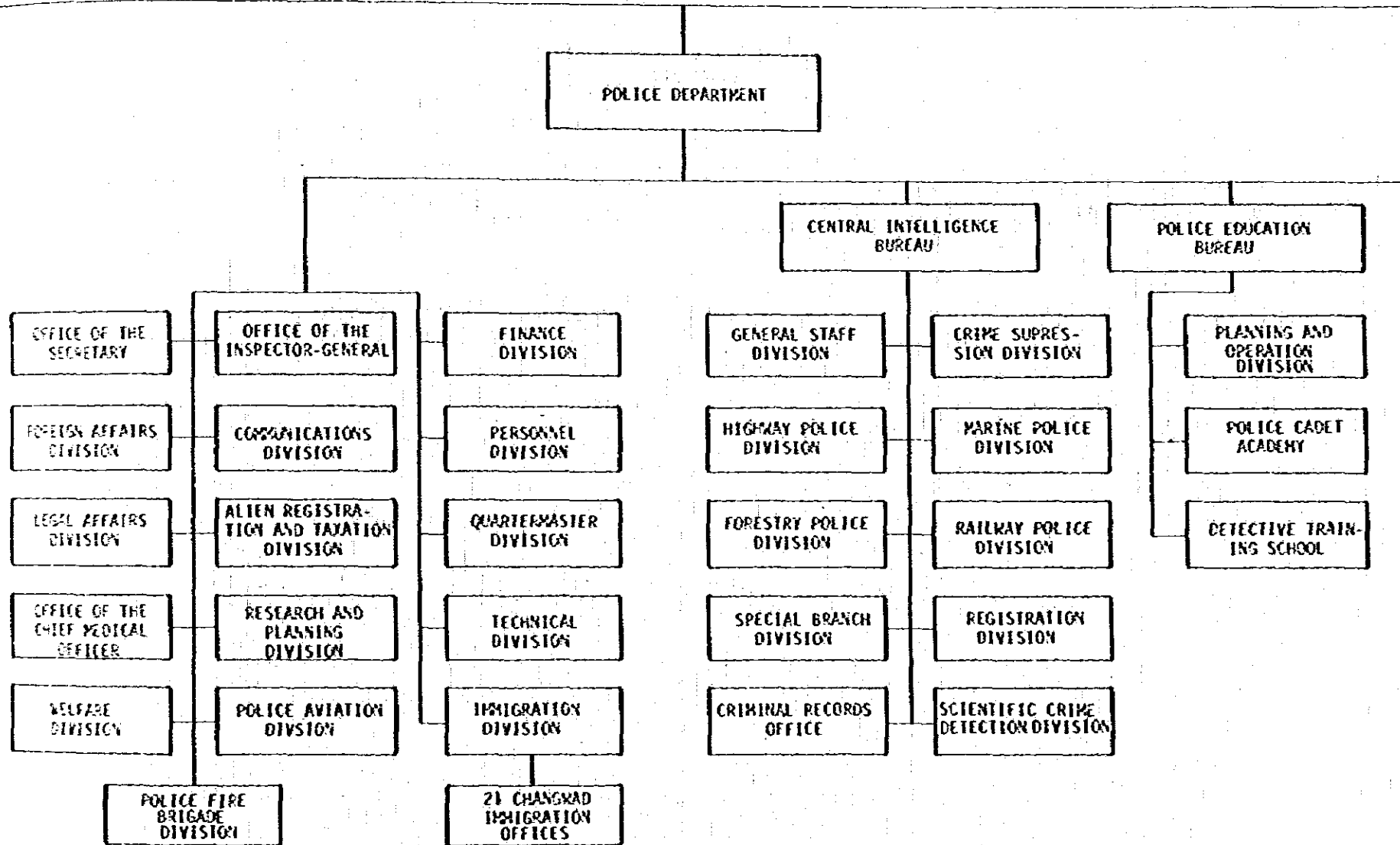

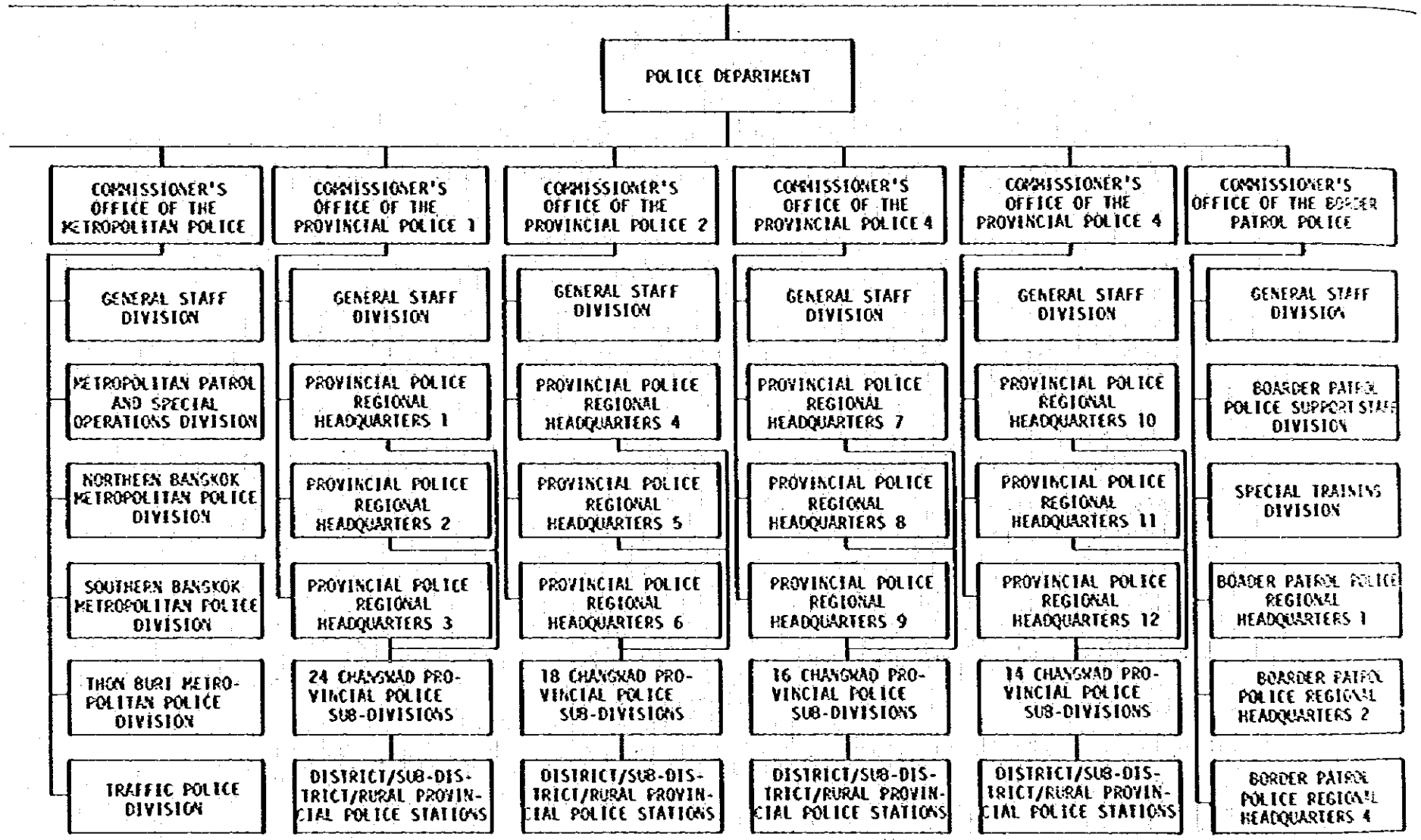

内務省

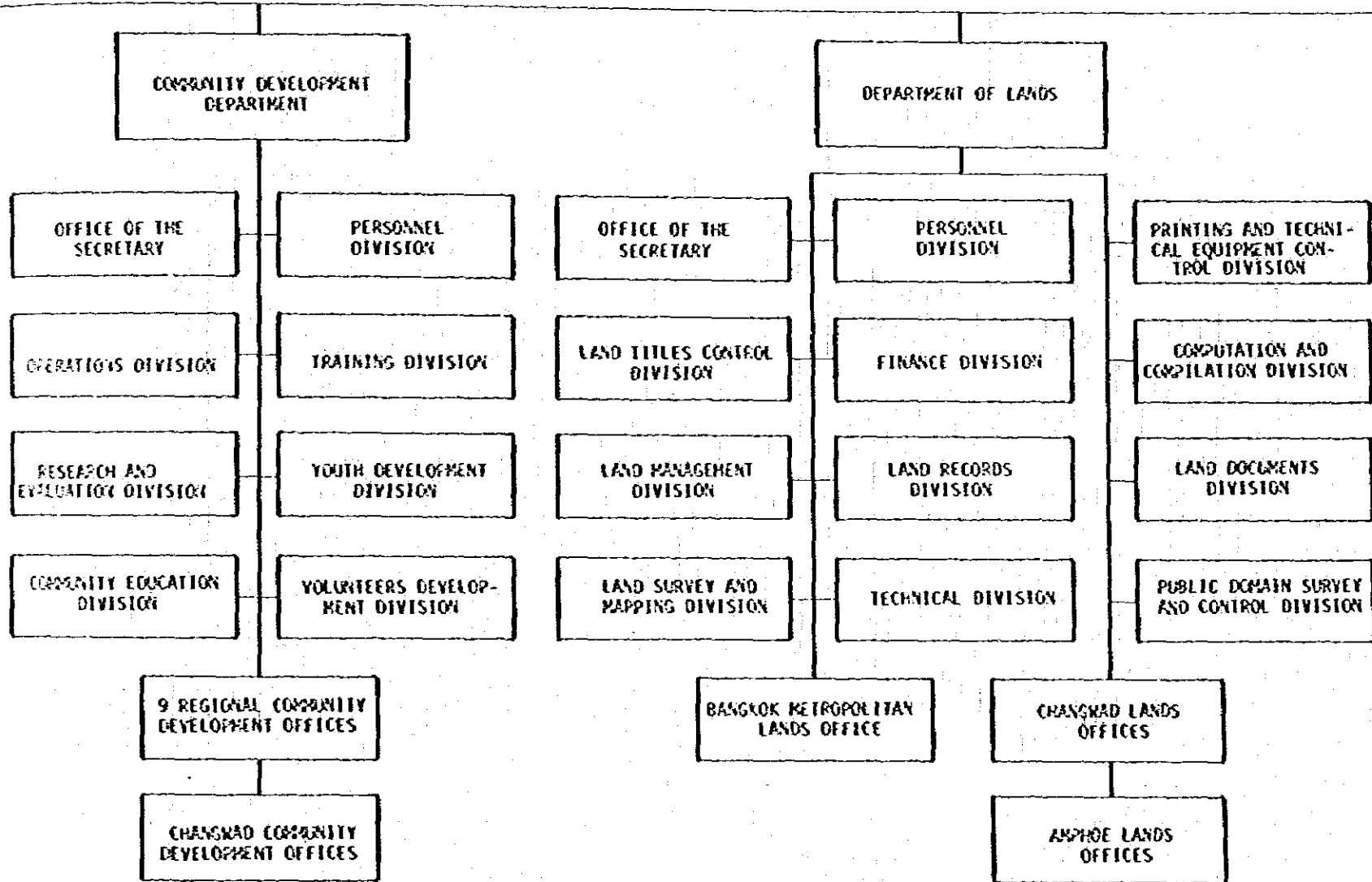

夕
イ

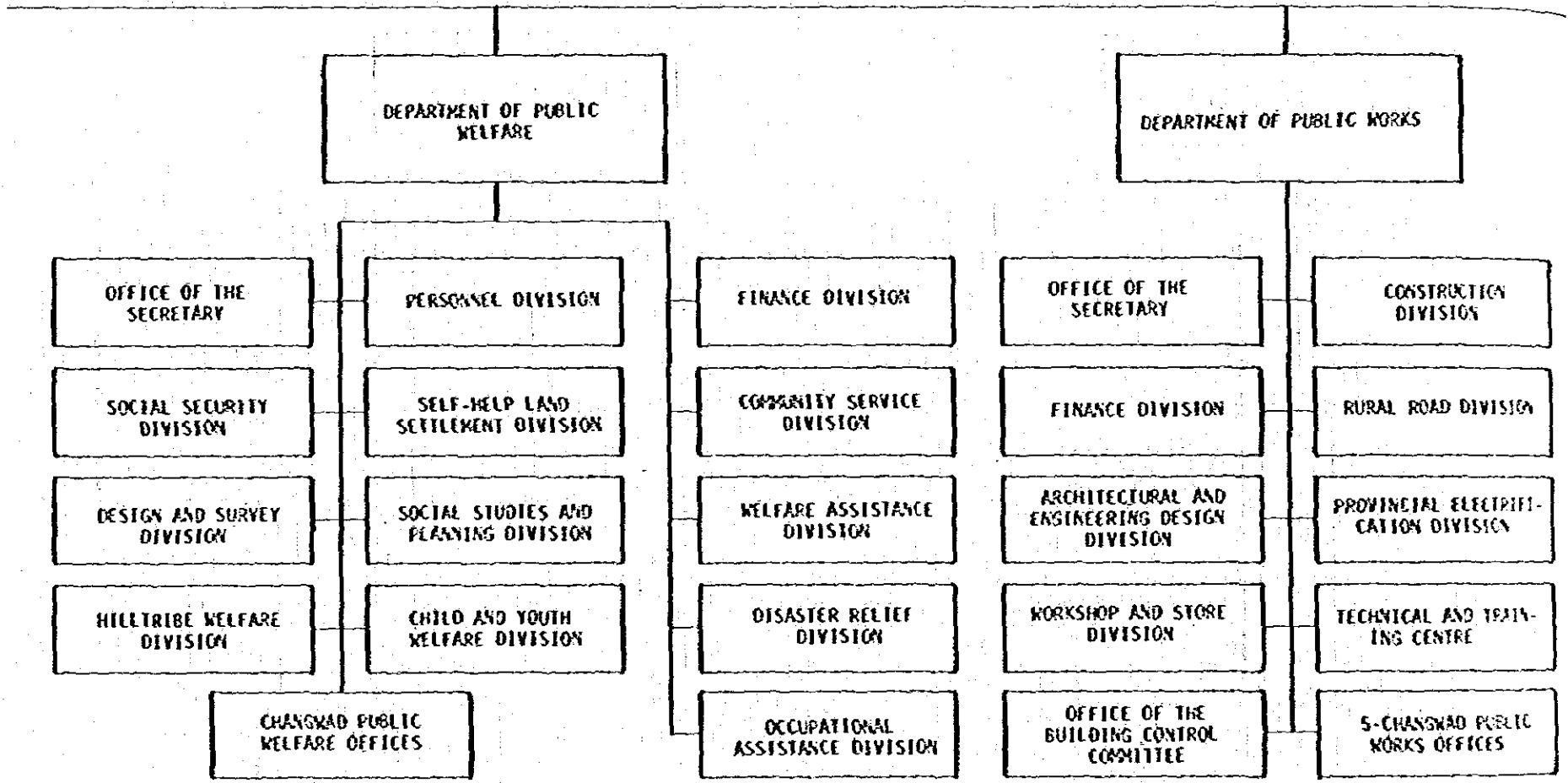

内
務
省
(5)

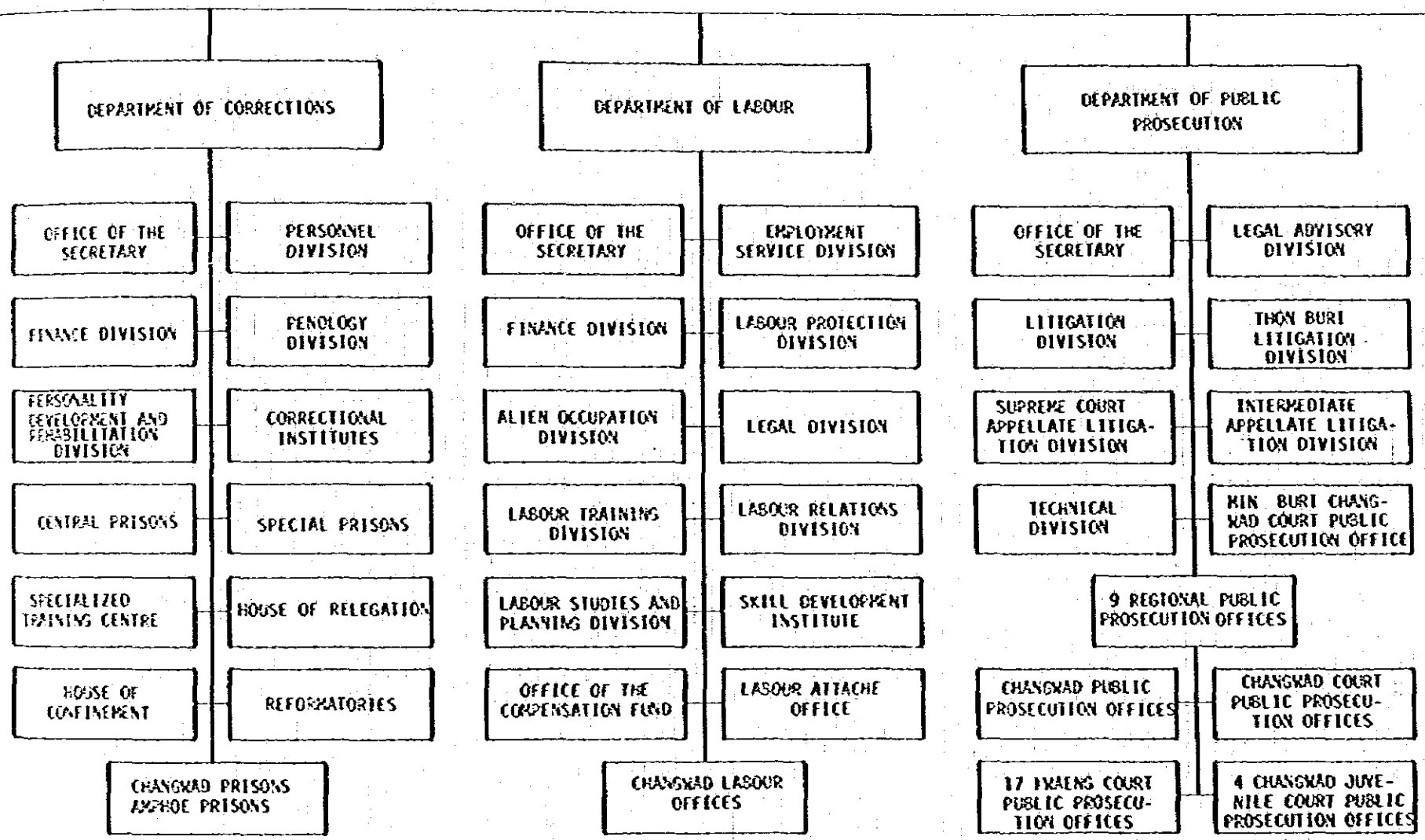

夕
1

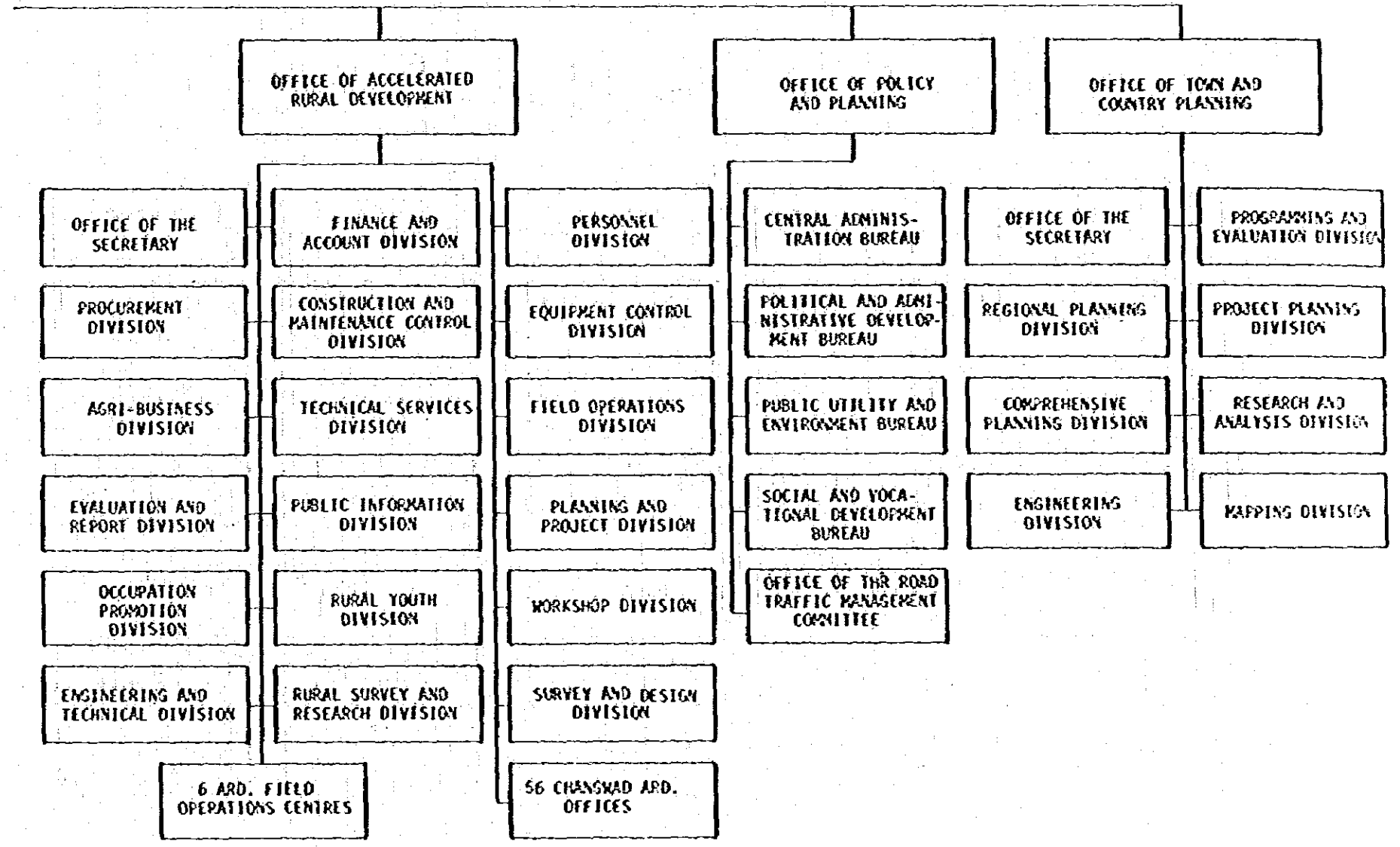

内
務
省
(1)

司 法 省 組 織 圖

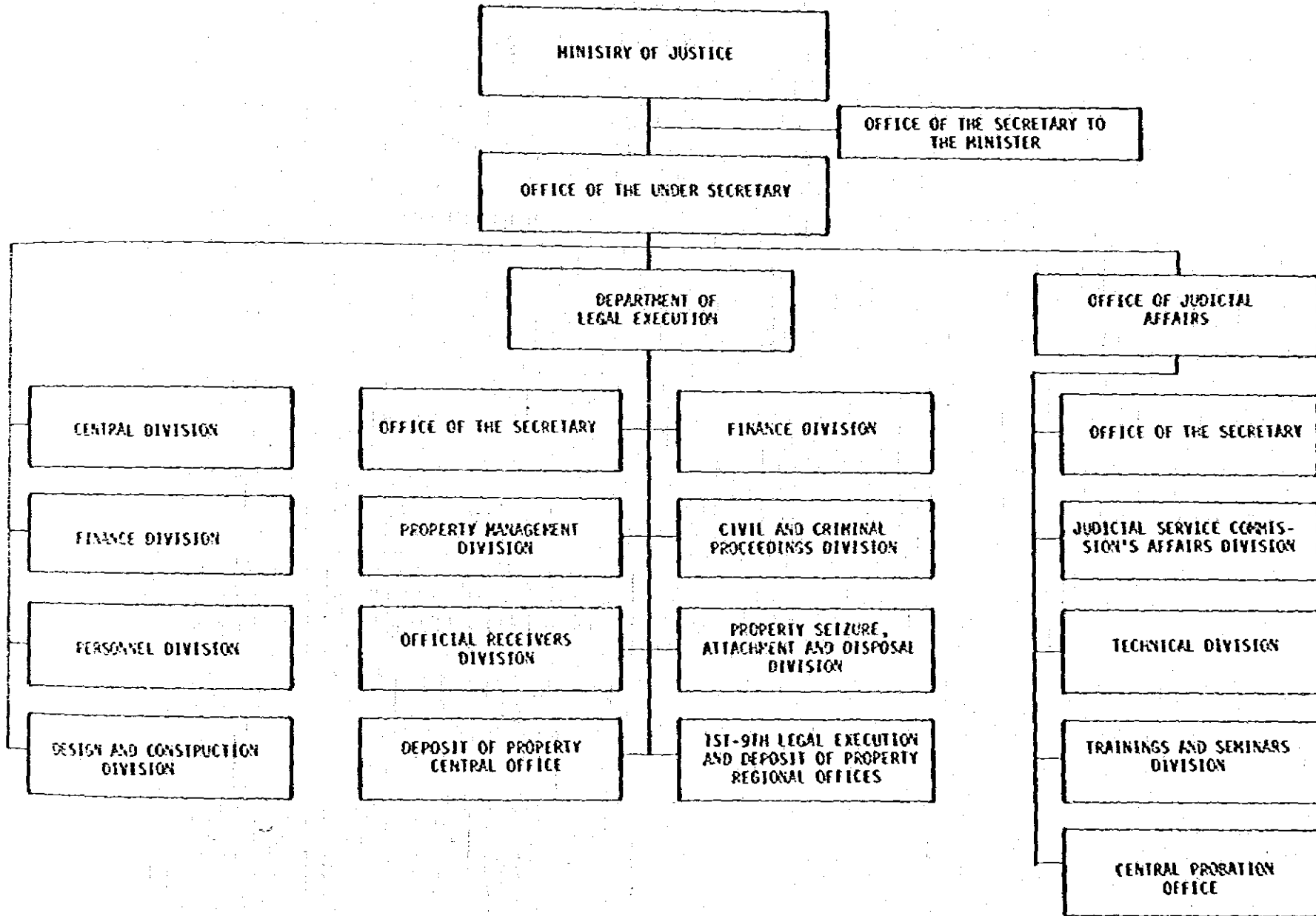

夕
イ

司
法
省
①

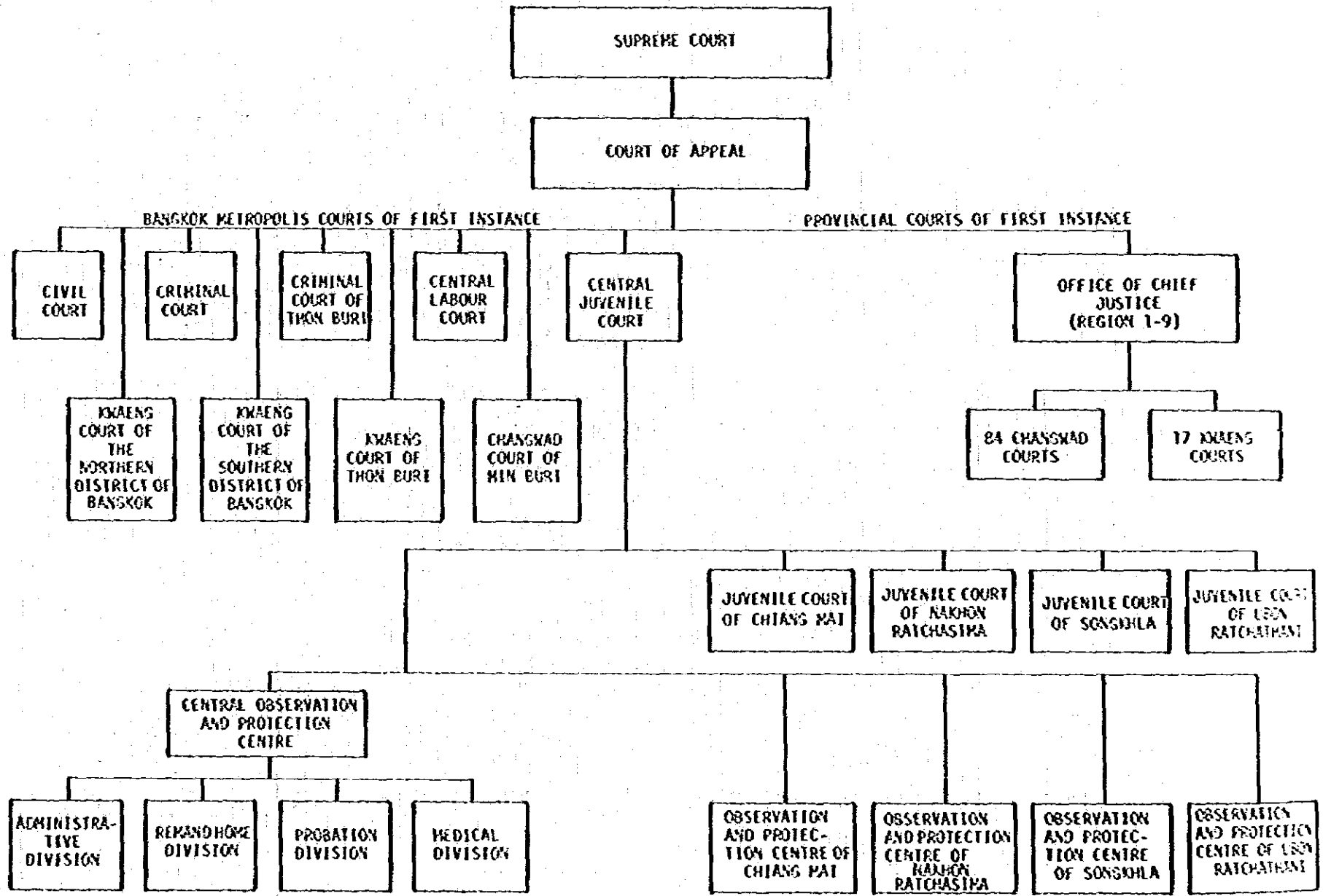

科学技術エネルギー省組織図

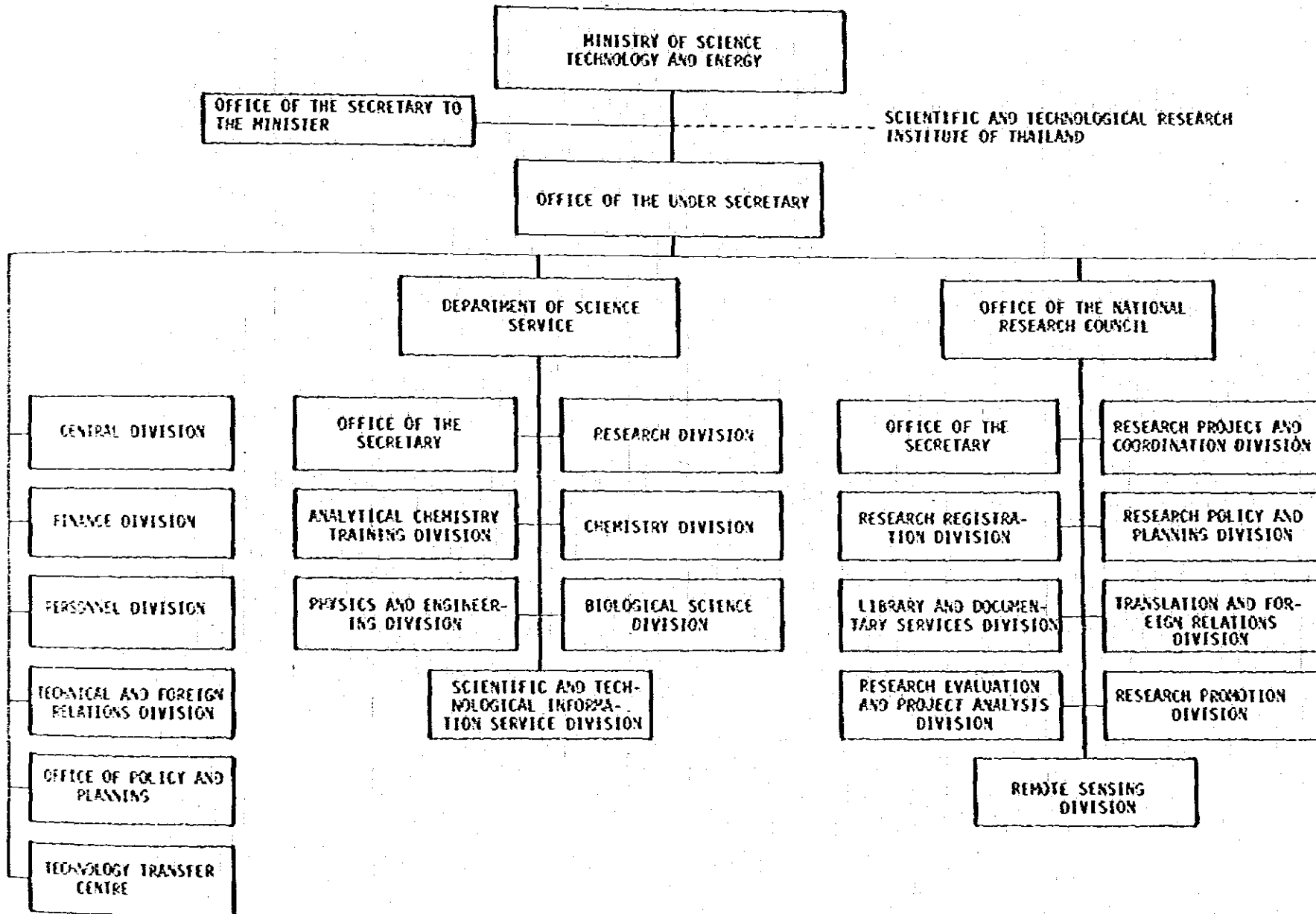

夕
イ

科学技術エネルギー省 (1)

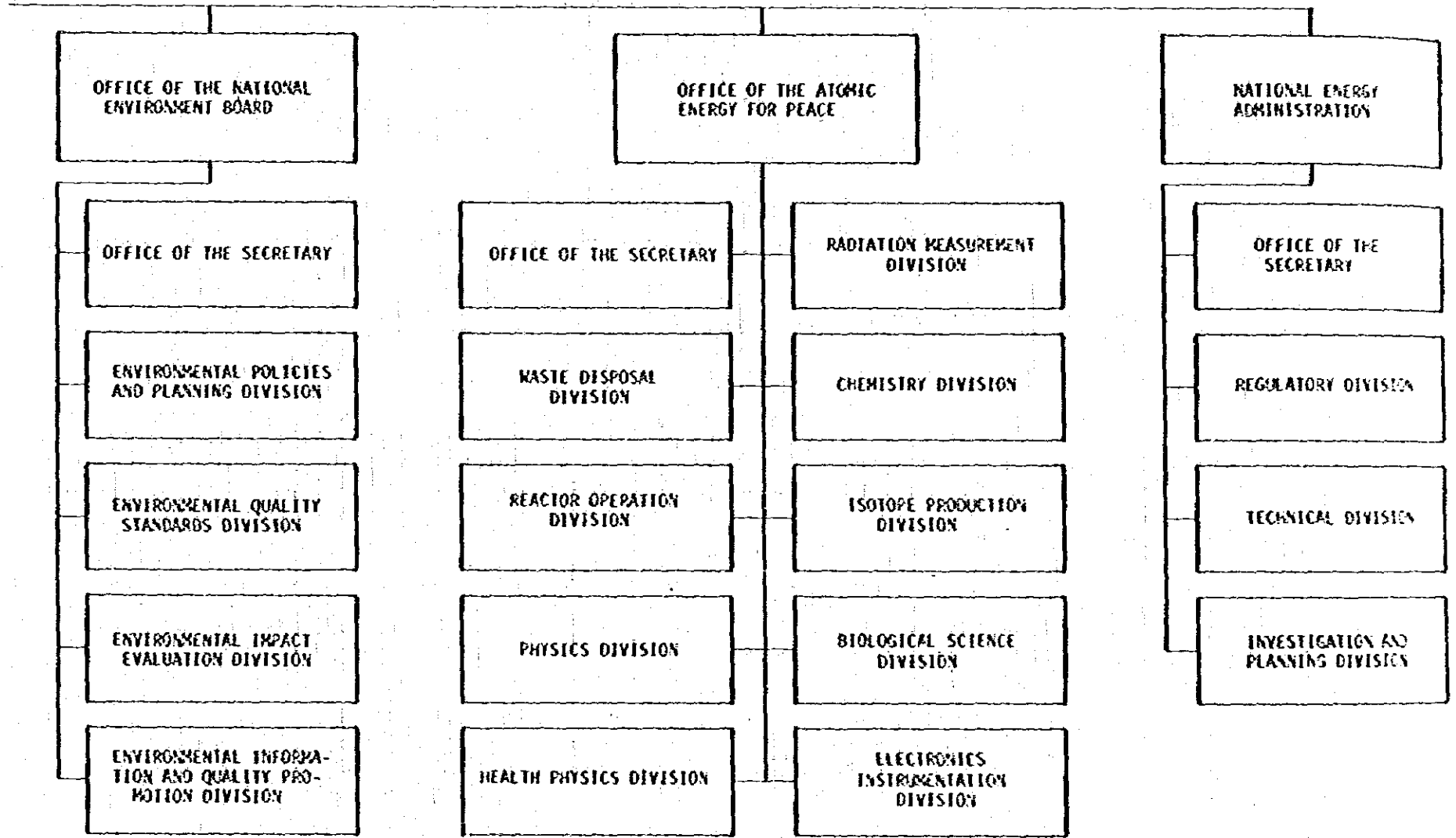

教 育 省 組 織 圖

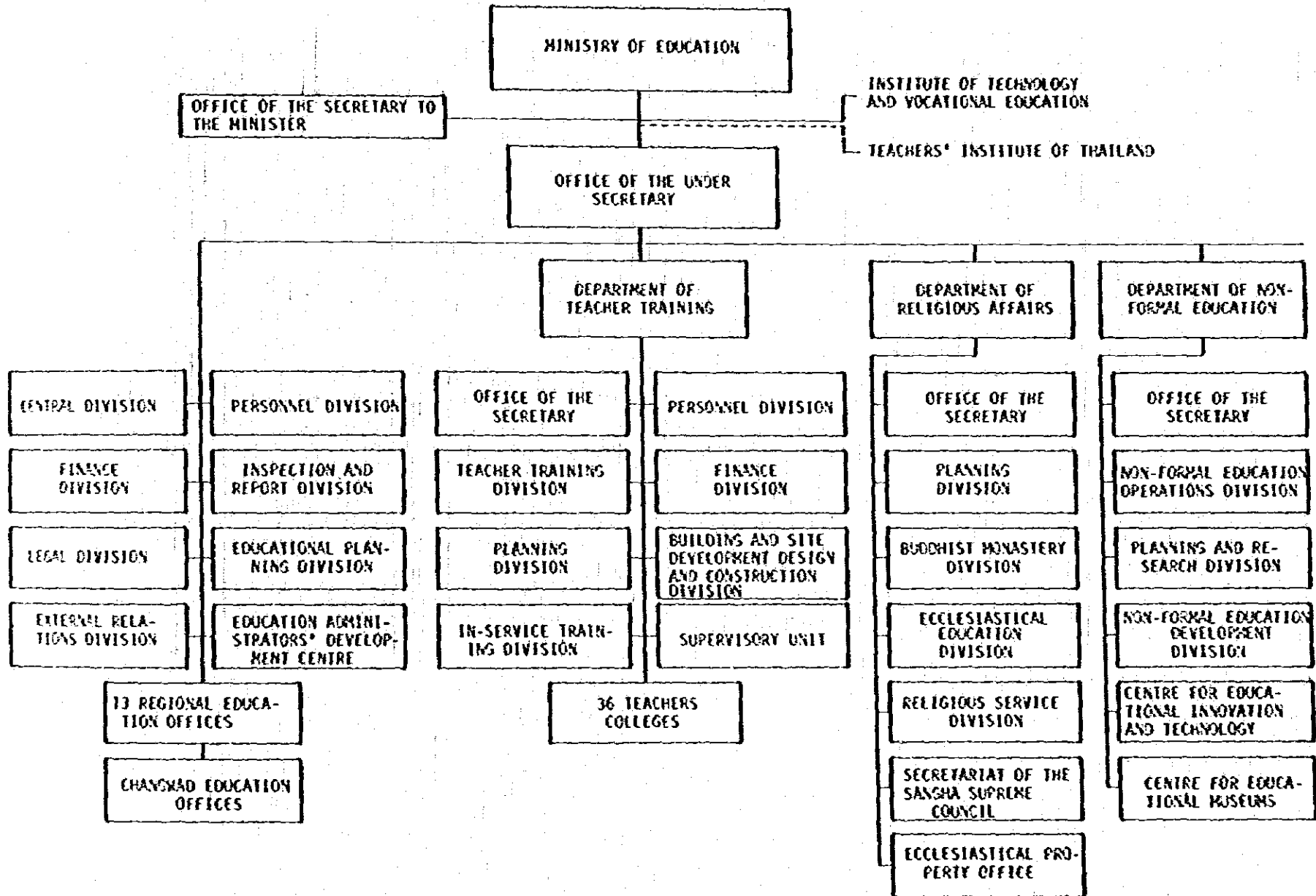

夕
1

教 育 省
(11)

夕
イ

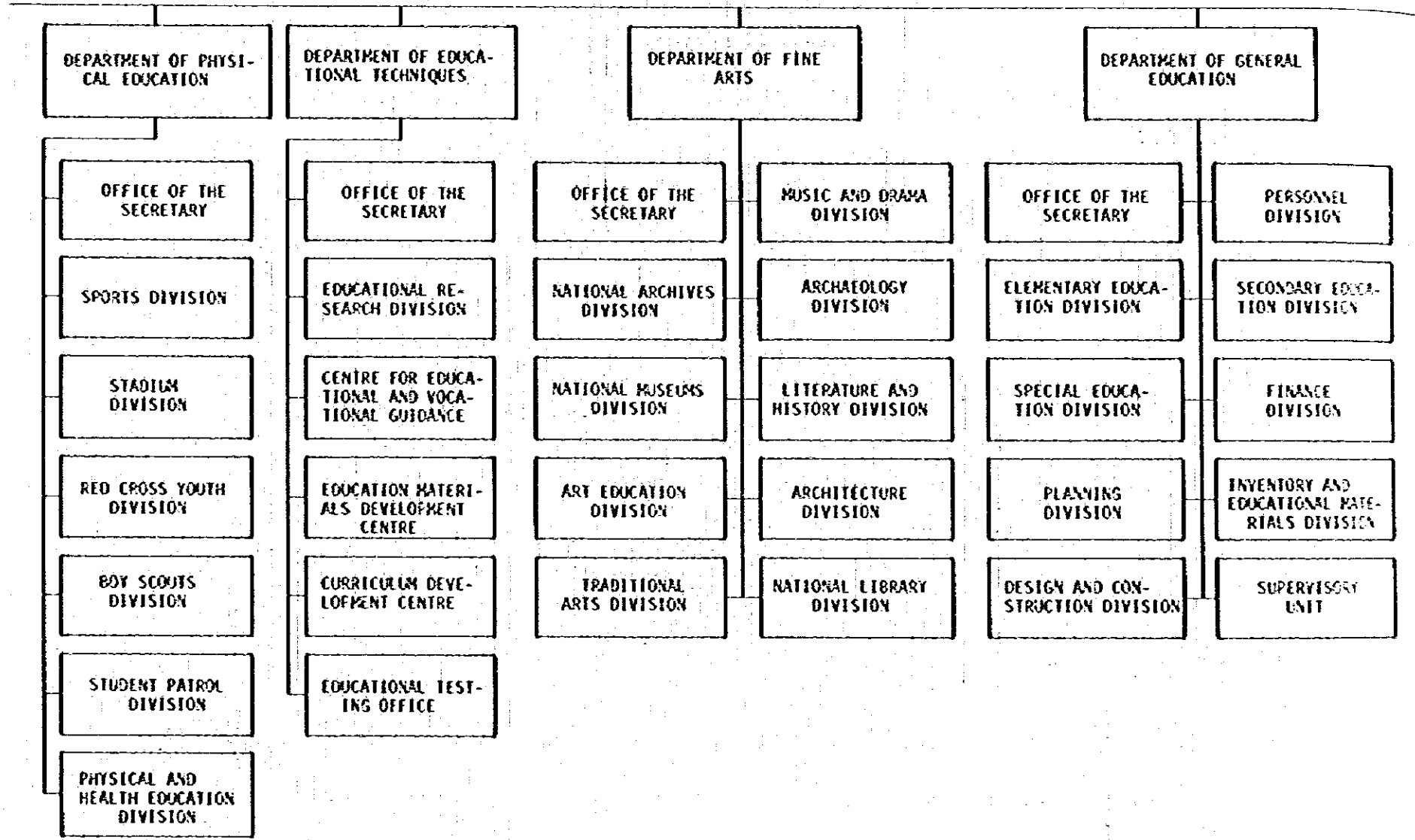

教
育
省
(2)

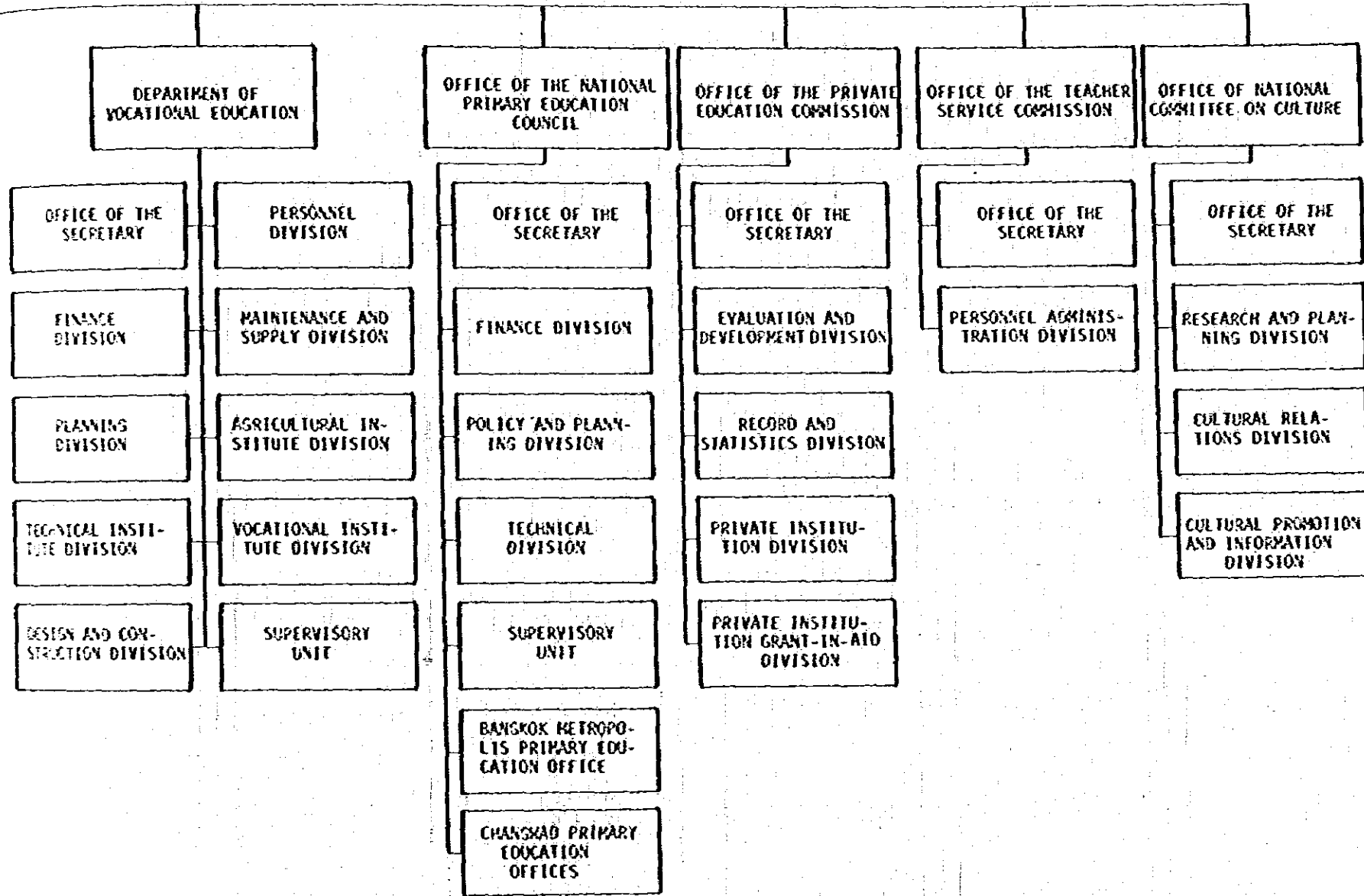

厚生省組織圖

夕
イ

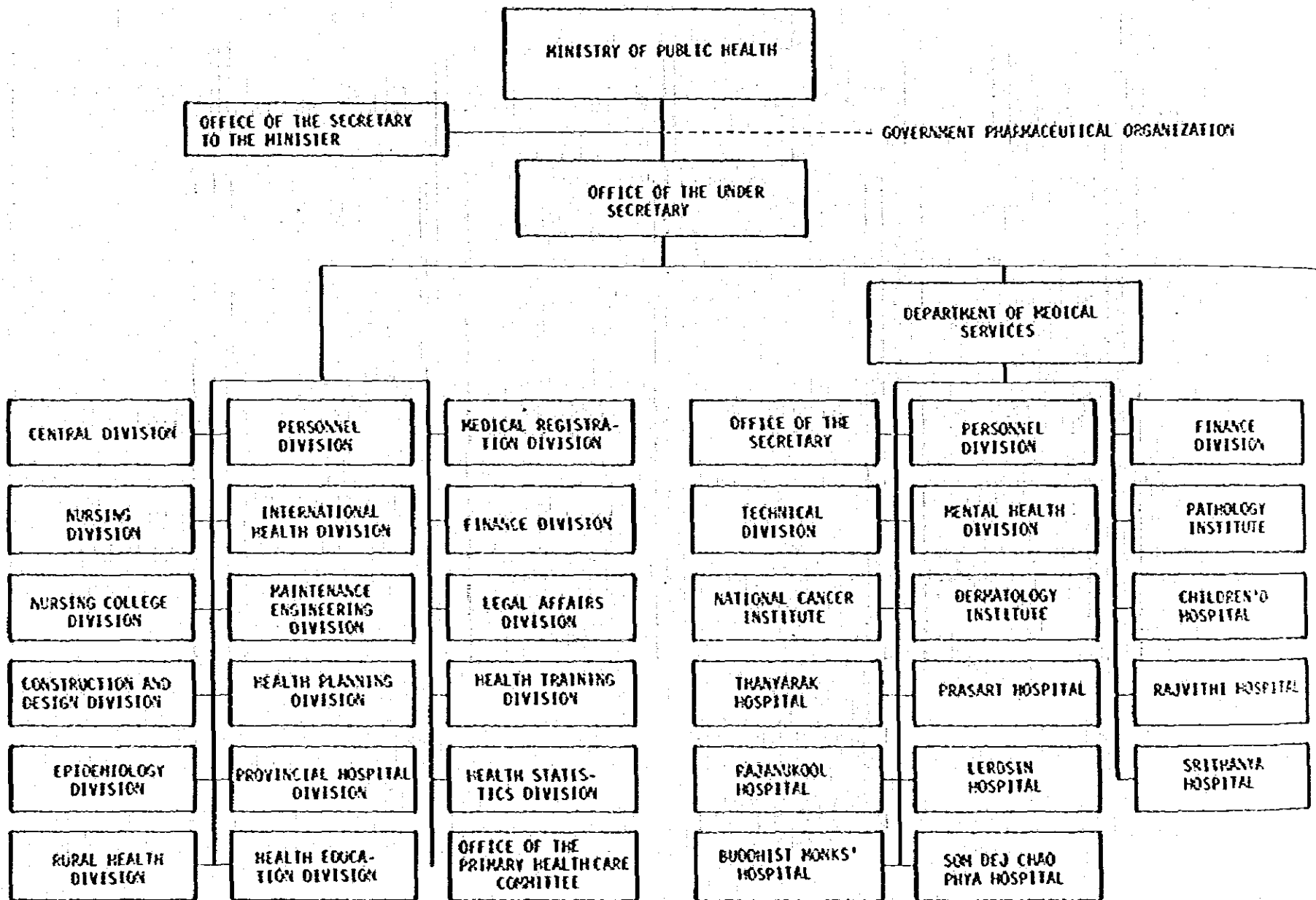

厚生省
(1)

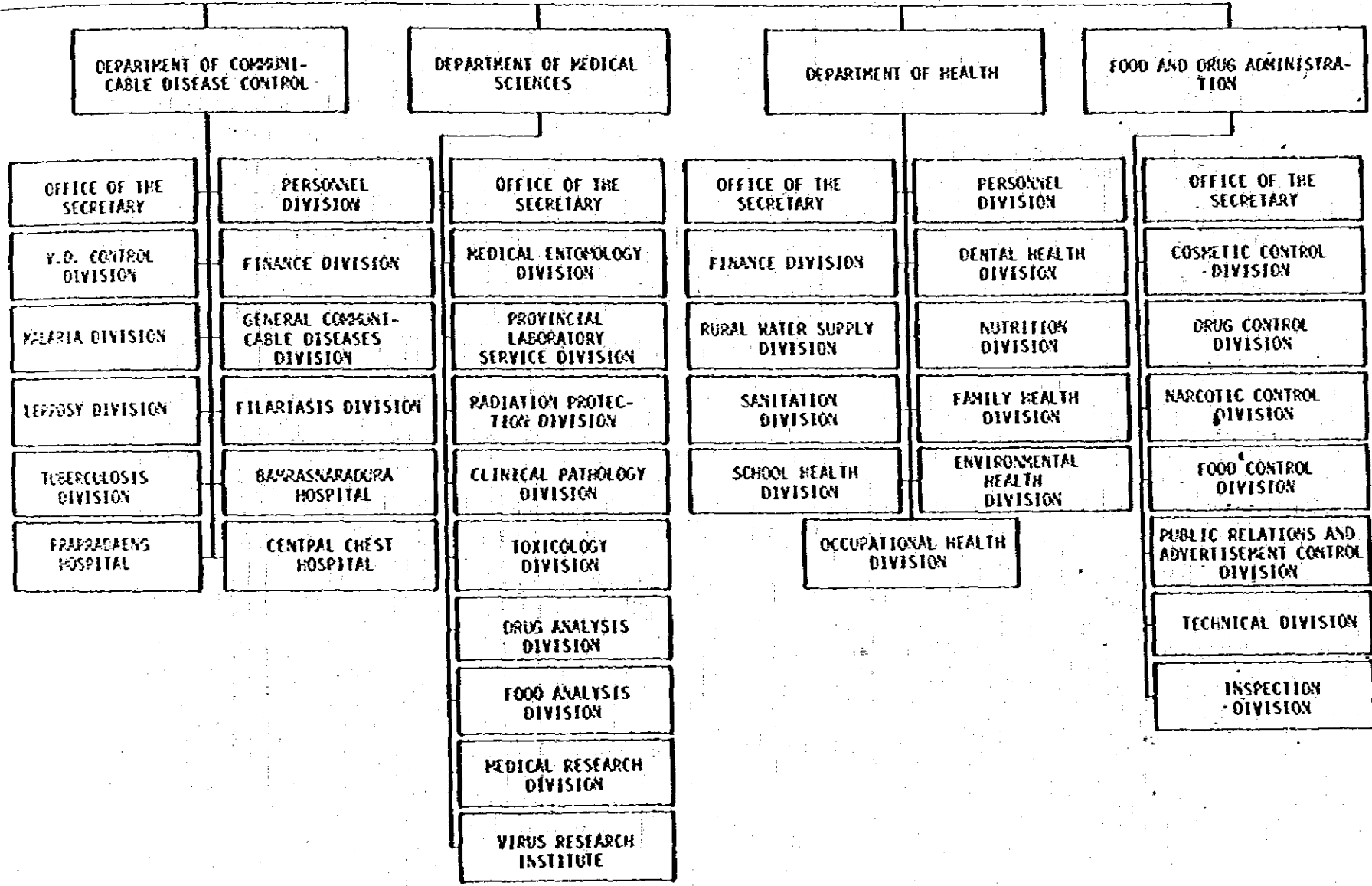

工業省組織圖

夕
イ

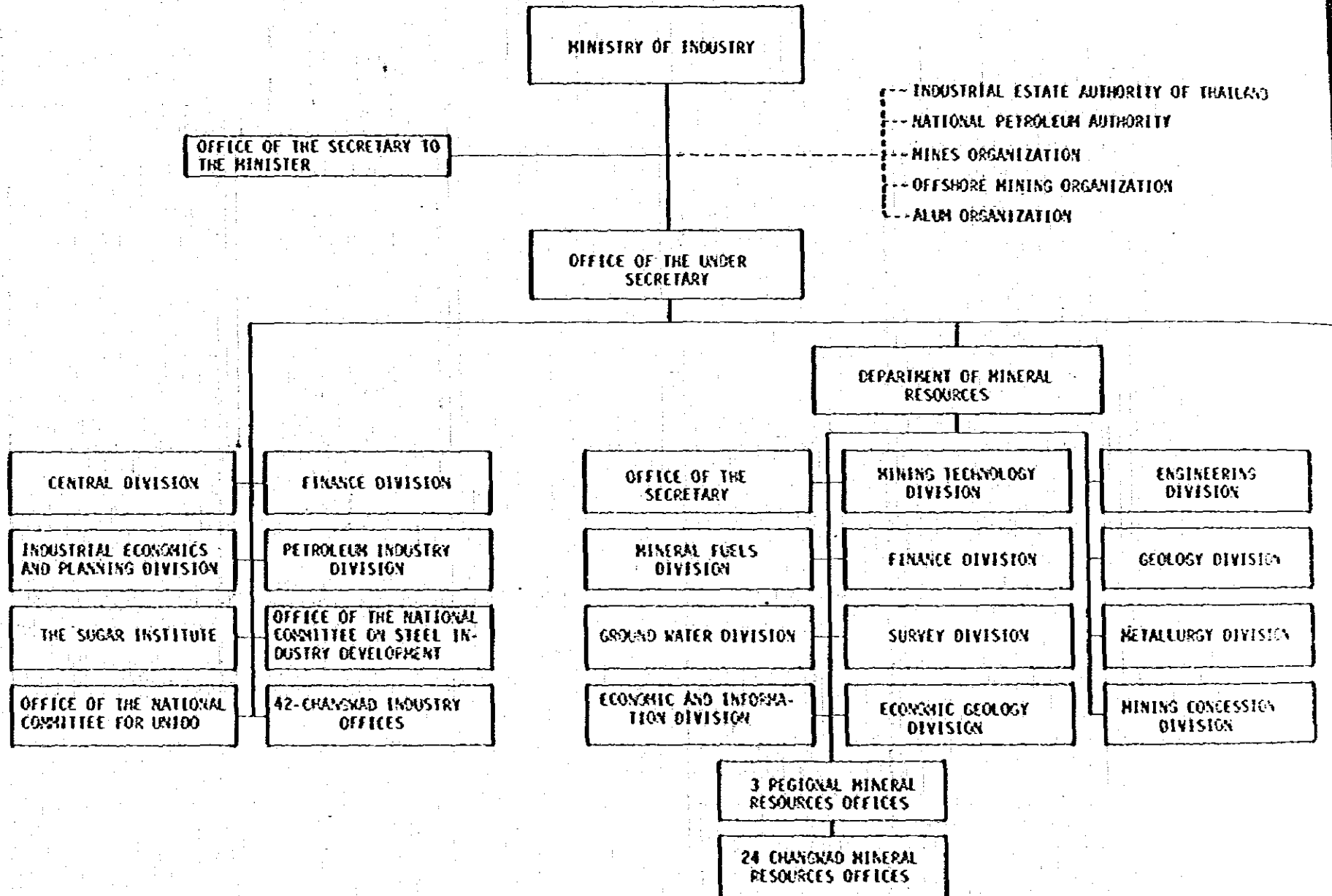

工業省
(11)

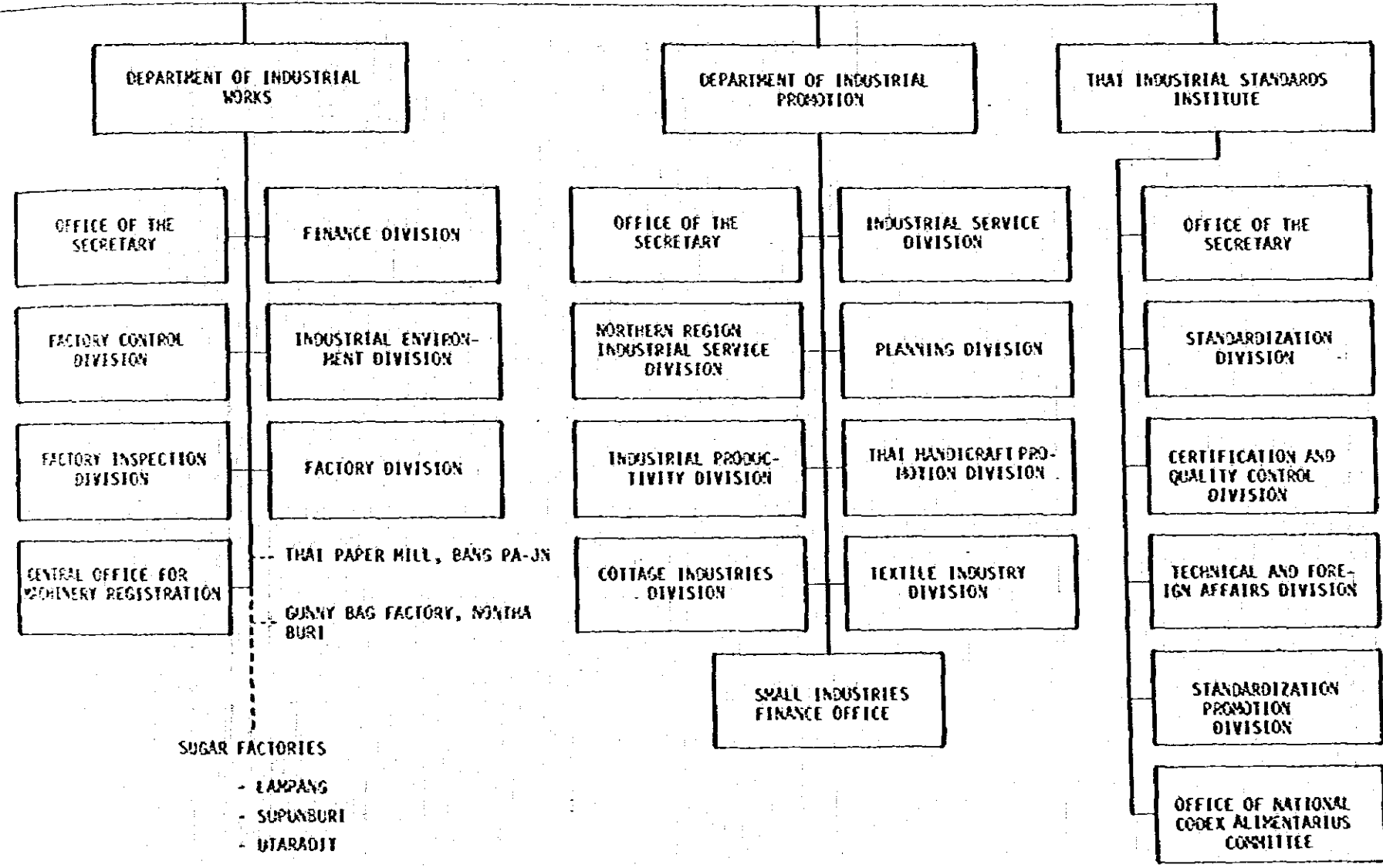

大 学 省 组 织 图

夕

イ

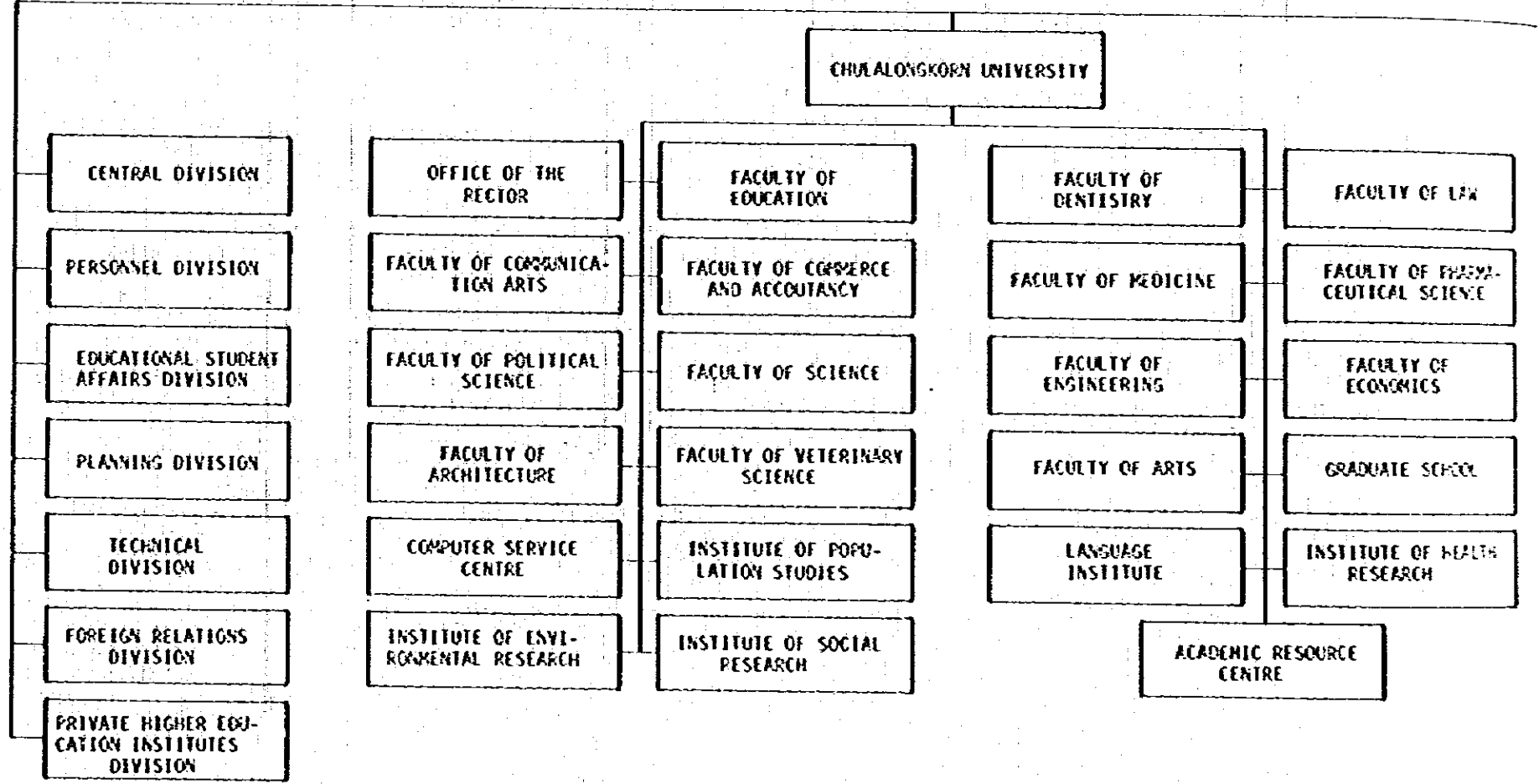
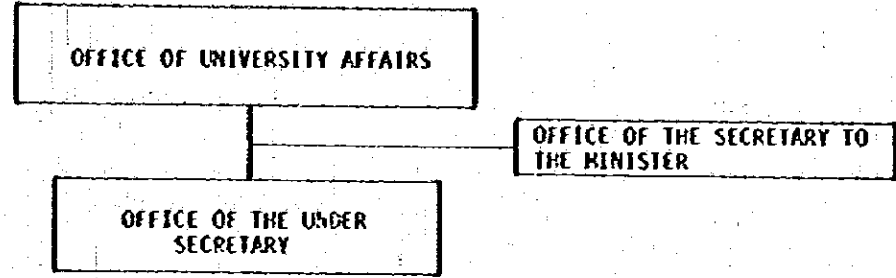

大 学 省 (11)

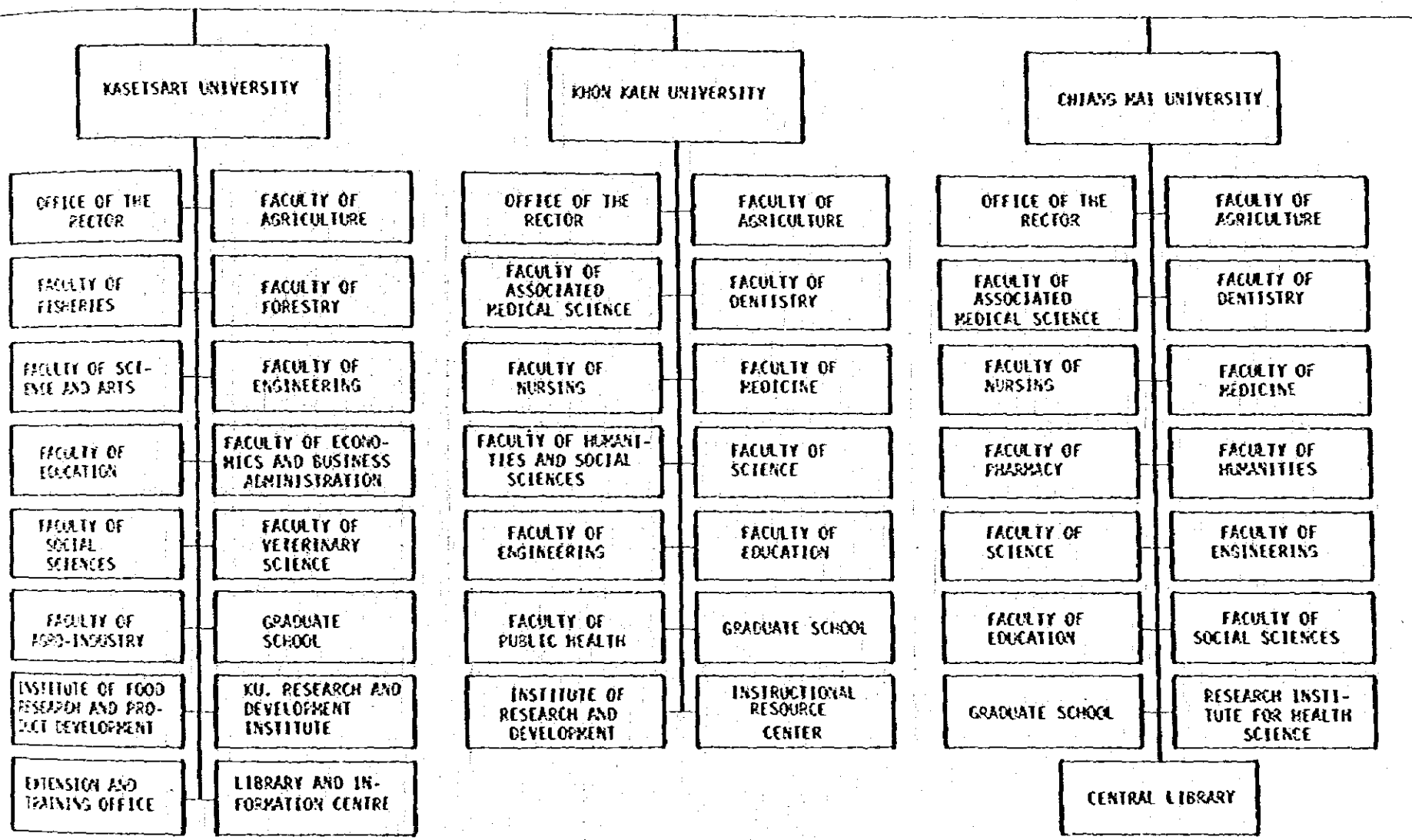

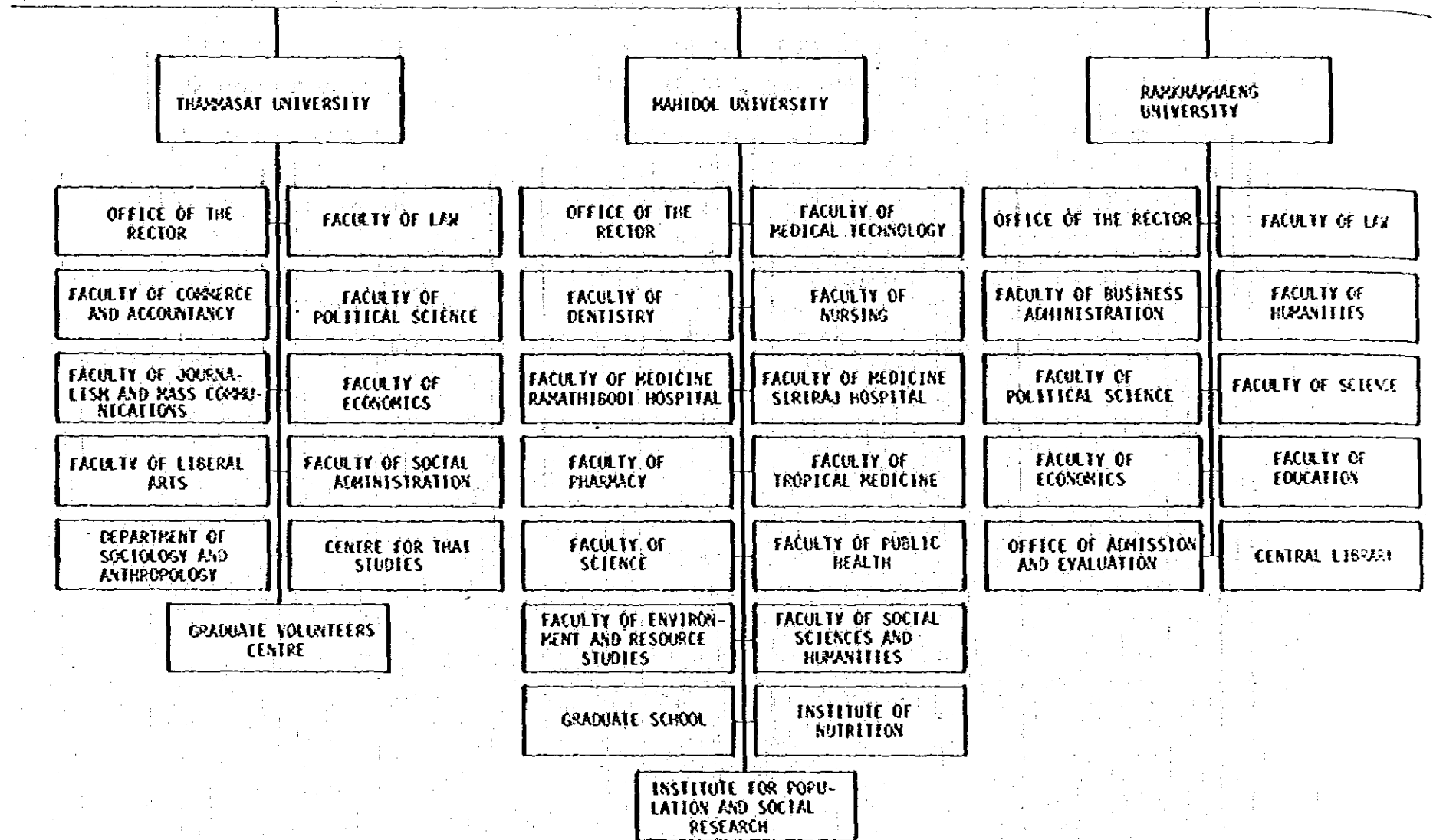

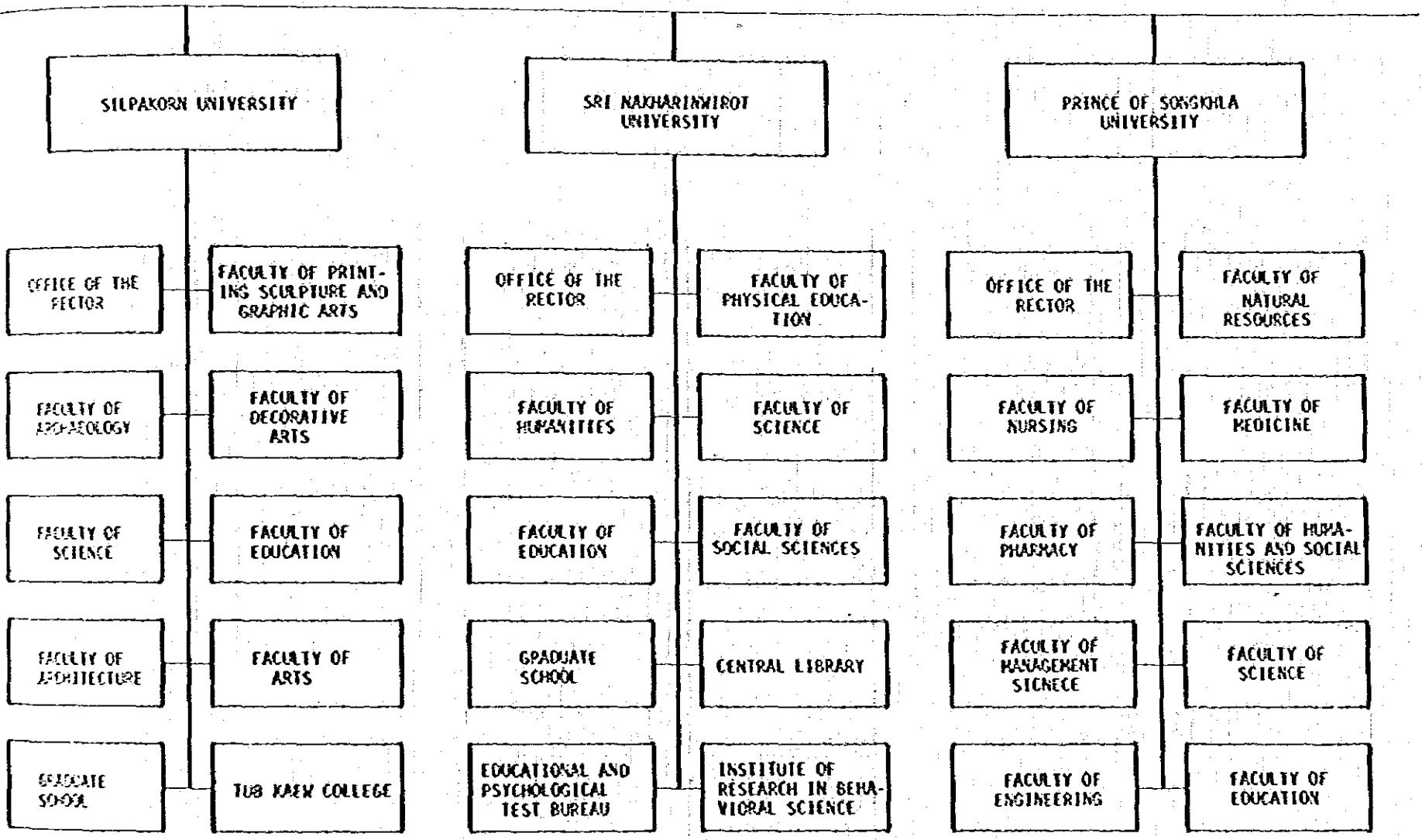

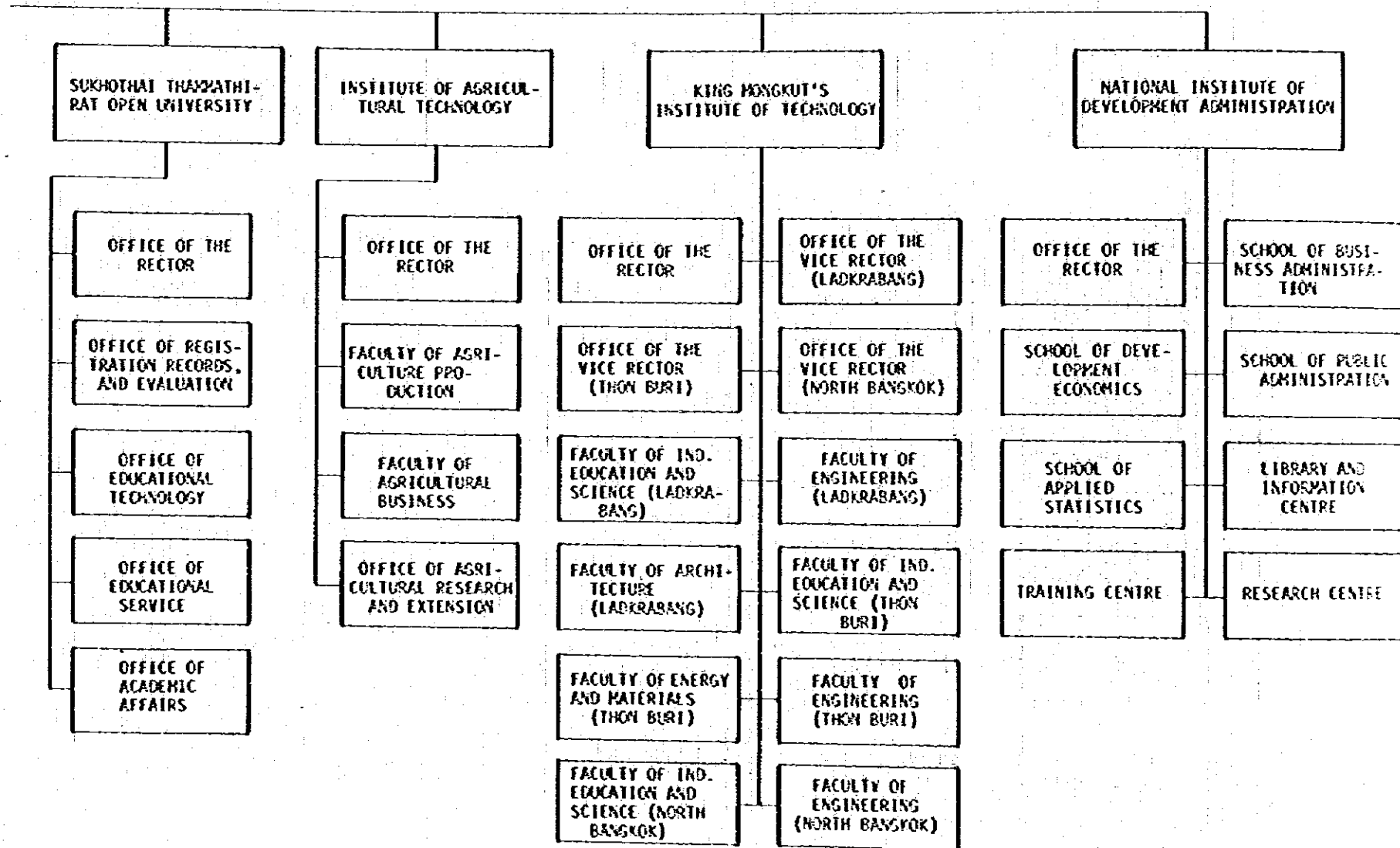

D T E C 組織圖

DTEC ORGANIZATION CHART

夕
1

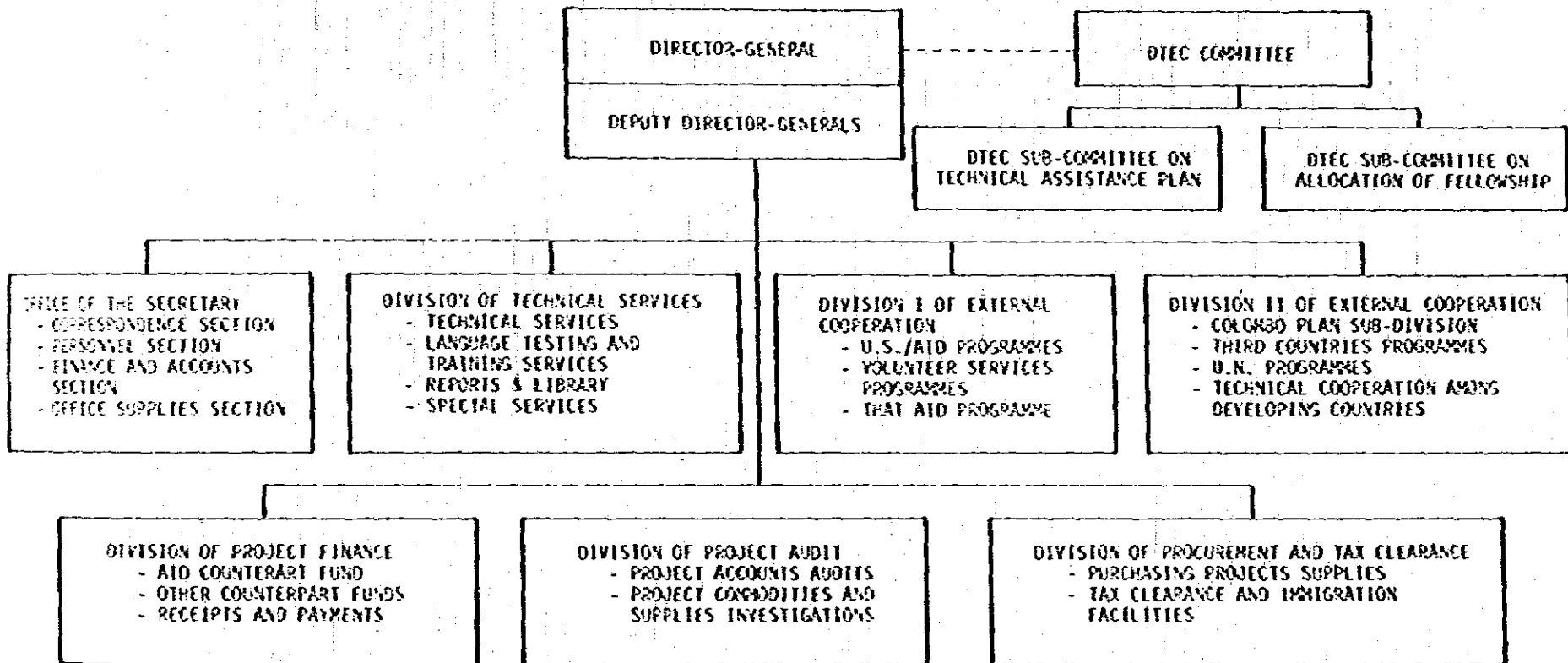

D
T
E
C

DTEC OPERATIONAL CHART

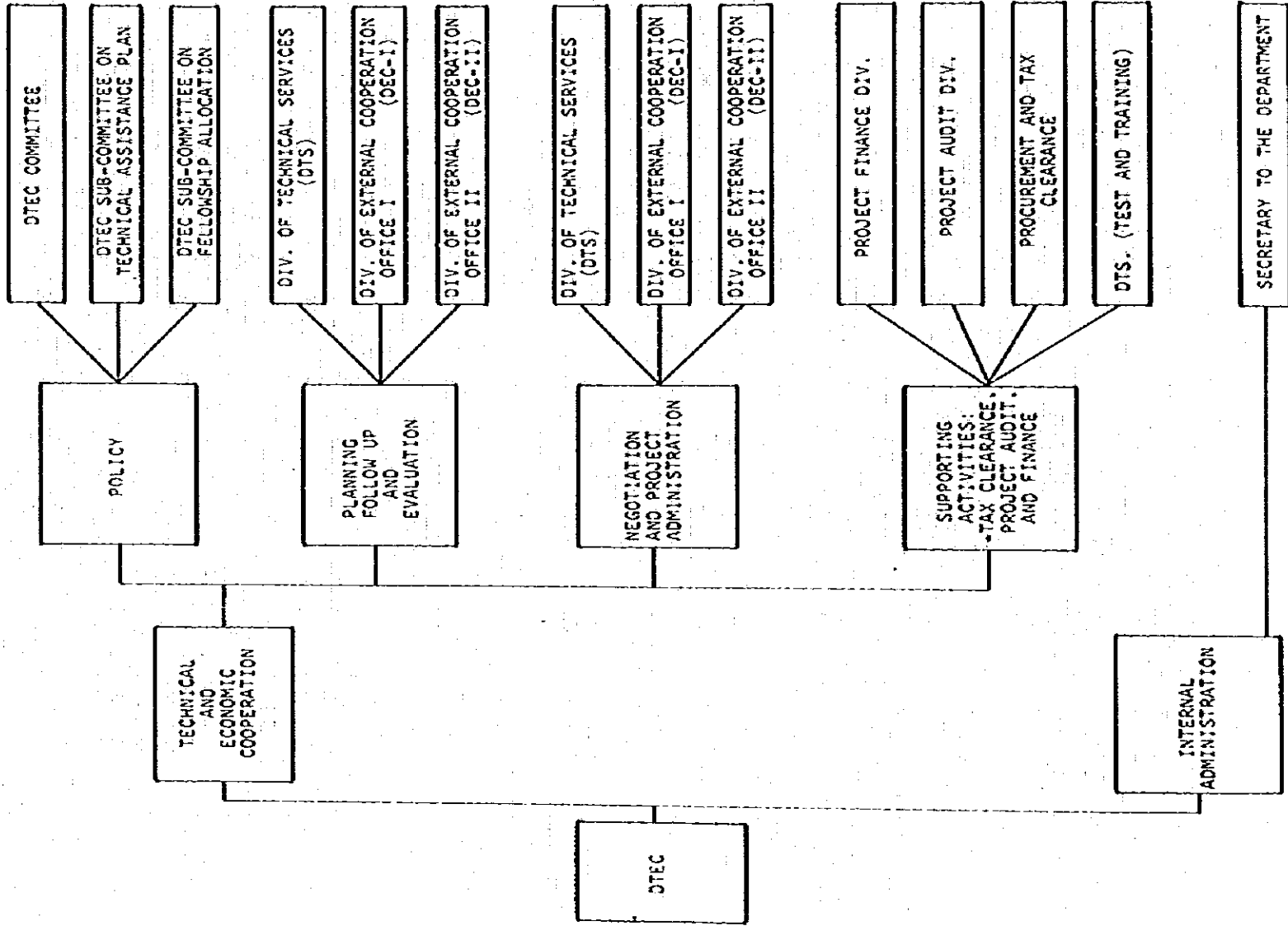

RELATIONSHIPS BETWEEN DTIC AND AUTHORITIES CONCERNING WITH TECHNICAL AND ECONOMIC COOPERATION

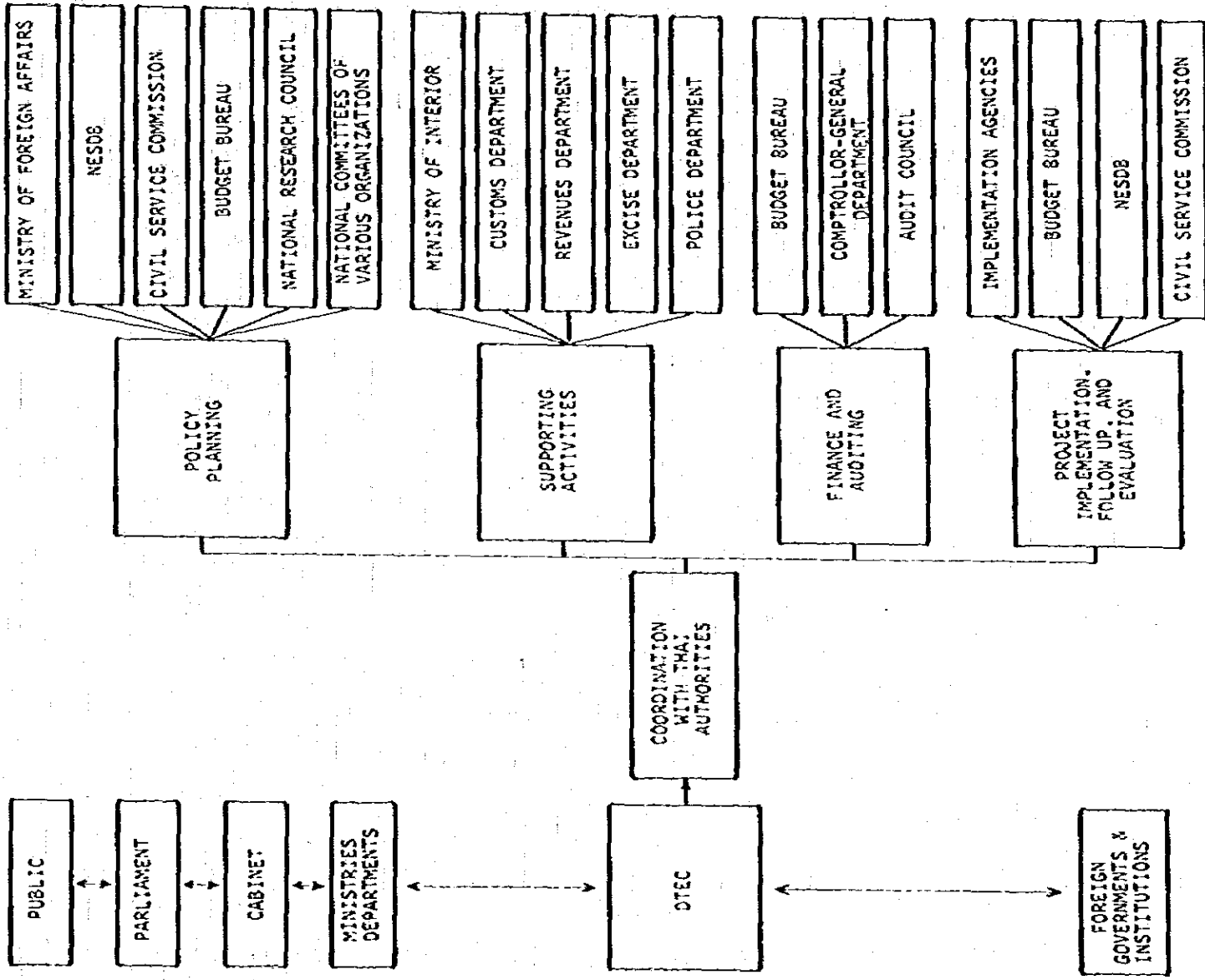

D T E C

1 7

タ
1

TECHNICAL AND ECONOMIC COOPERATION

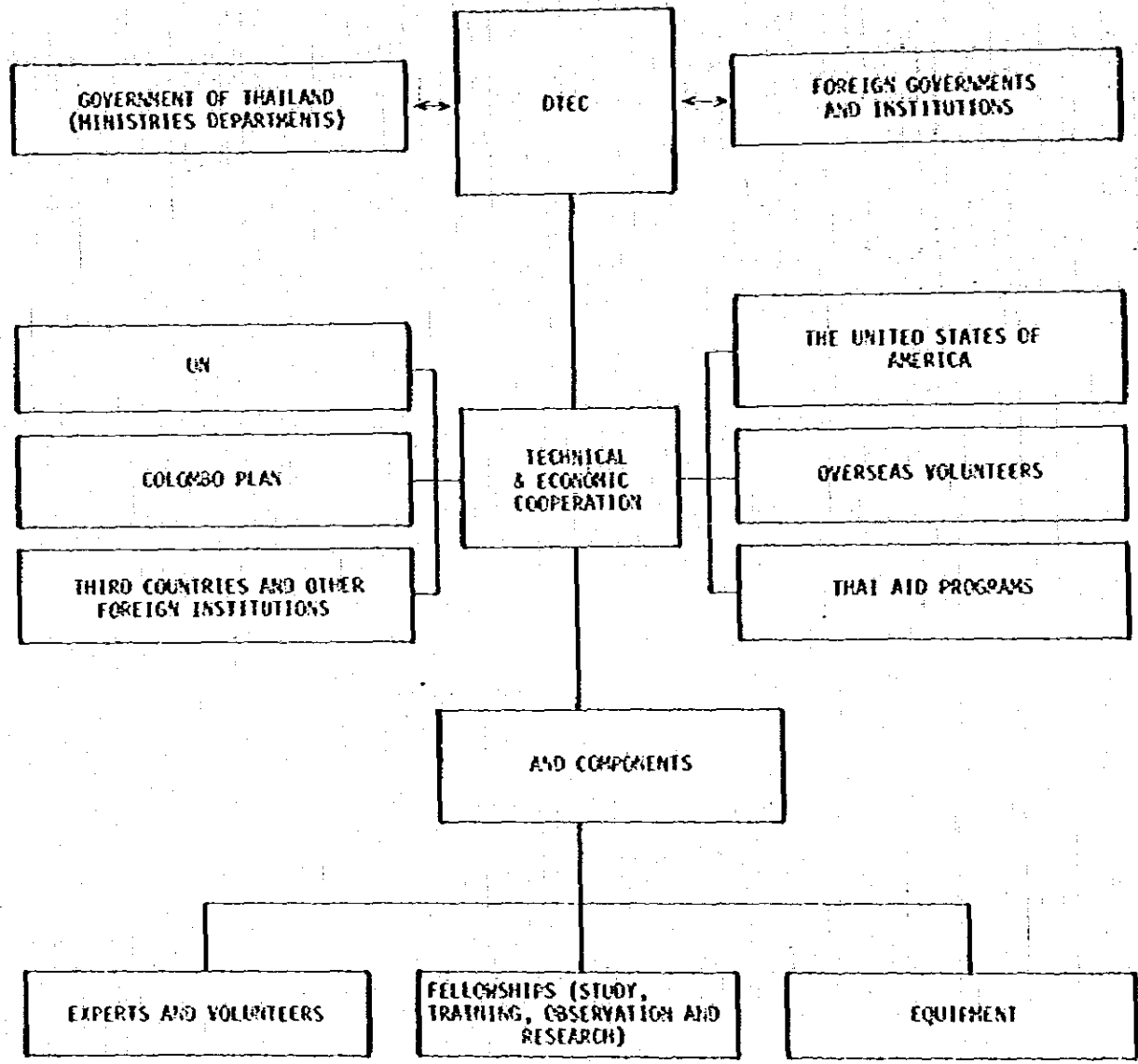

D
T
E
C

グイエトナム国政府行政組織図(1)

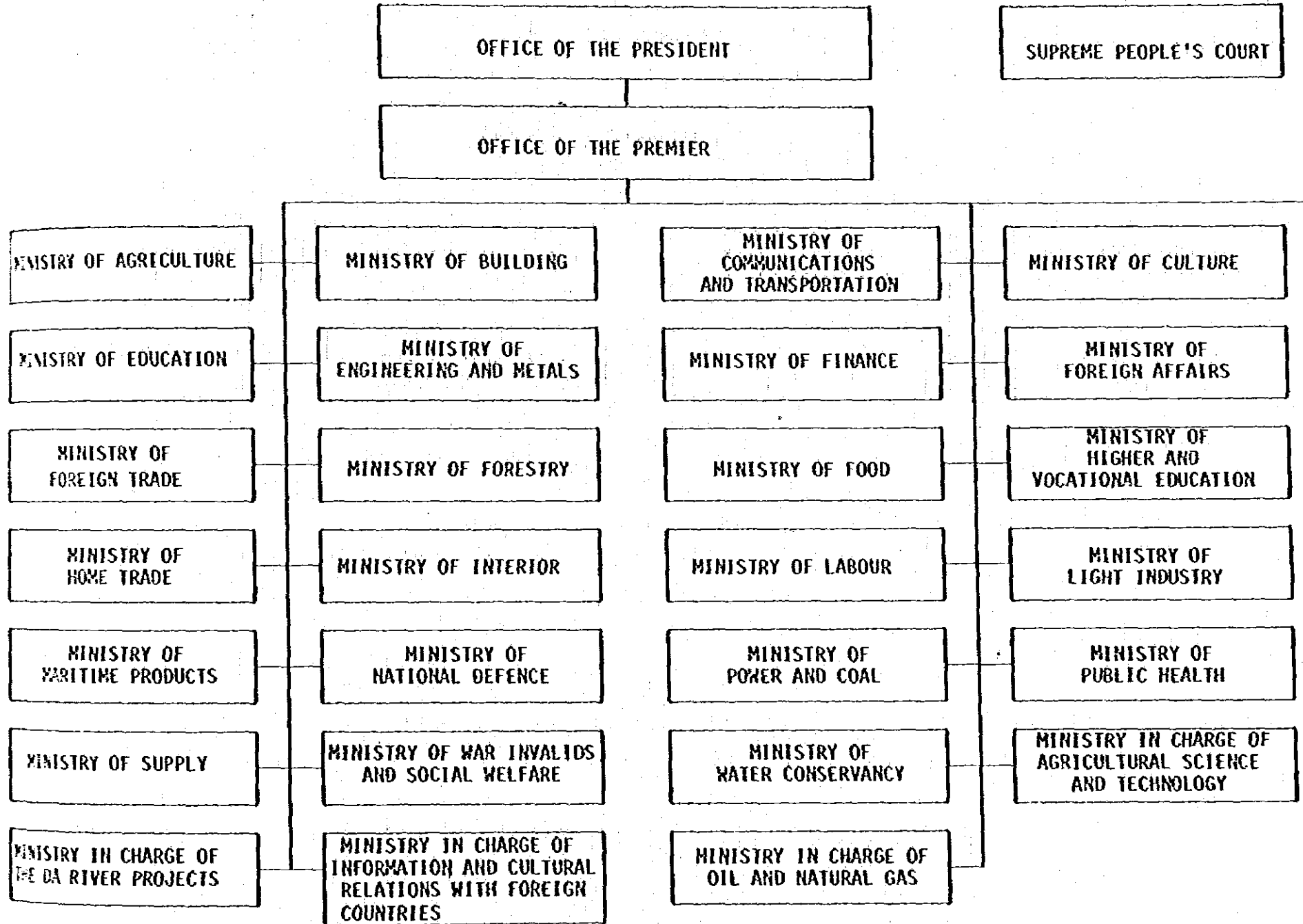

グ
イ
エ
ト
ナ
ム

行
政
組
織
(1)

グイエトナム国政府行政組織図(2)

グ
イ
エ
ト
ナ
ム

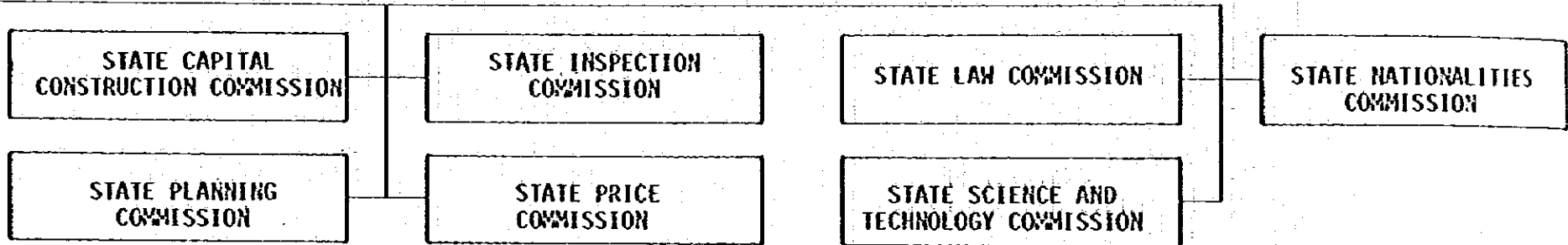

行
政
組
織
(2)

ブルネイ國政府行政組織圖

(LEGISLATIVE COUNCIL)
DUN BAHARU NEGERI

OFFICE OF H.H. THE SULTAN

SUPREME COURT

ブルネイ

OFFICE OF THE GENERAL ADVISER
TO H.H. THE SULTAN

OFFICE OF THE MENTERI
BESAR (CHIEF MINISTER)

OFFICE OF
THE STATE SECRETARY

OFFICE OF THE STATE
FINANCIAL OFFICER

OFFICE OF
THE ATTORNEY GENERAL

OFFICE OF THE HEAD OF
RELIGIOUS AFFAIRS

行政組織

中近東地域

OFFICE OF THE GENERAL SECRETARY OF THE
CENTRAL COMMITTEE, PRESIDENT OF THE
REVOLUTIONARY COUNCIL AND PRIME MINISTER

SUPREME JUDICIAL
COUNCIL

アフガニスタン

MINISTRY OF AGRICULTURE
AND LAND REFORM

MINISTRY OF COMMERCE

MINISTRY OF
COMMUNICATIONS

MINISTRY OF EDUCATION

MINISTRY OF FINANCE

MINISTRY OF
FOREIGN AFFAIRS

MINISTRY OF
FRONTIER AFFAIRS

MINISTRY OF
HIGHER EDUCATION

MINISTRY OF INFORMATION
AND CULTURE

MINISTRY OF INTERIOR

MINISTRY OF JUSTICE
AND OFFICE OF THE
ATTORNEY GENERAL

MINISTRY OF MINES
AND INDUSTRIES

MINISTRY OF NATIONAL
DEFENCE

MINISTRY OF PLANNING
AFFAIRS

MINISTRY OF PUBLIC
HEALTH

MINISTRY OF PUBLIC
WORKS

MINISTRY OF TRANSPORT

MINISTRY OF WATER
AND POWER

行政組織

アルジェリア国政府行政組織図

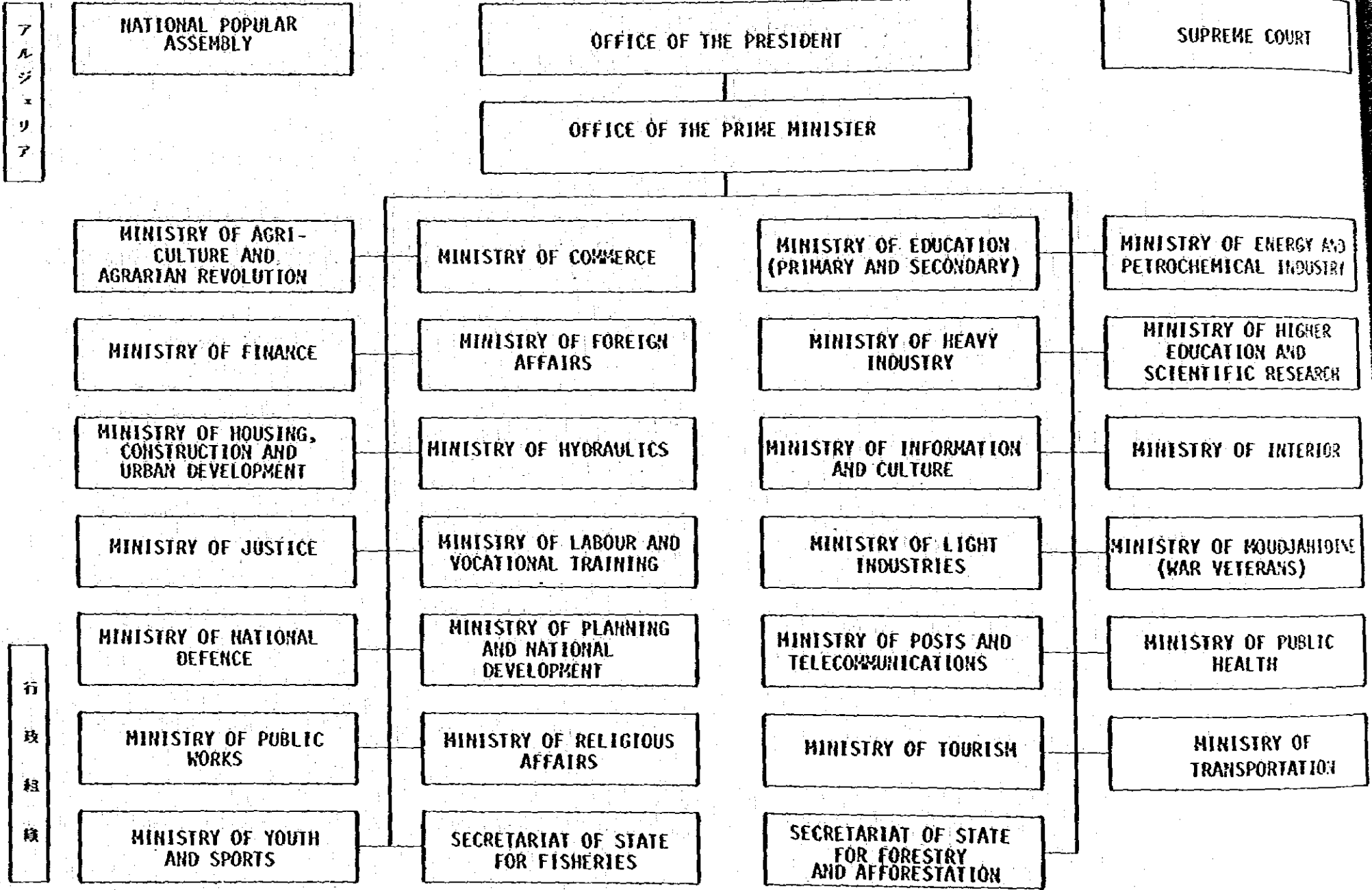

アル
ジ
エ
リ
ア

行
政
組
織

MINISTÈRE DE L' AGRICULTURE

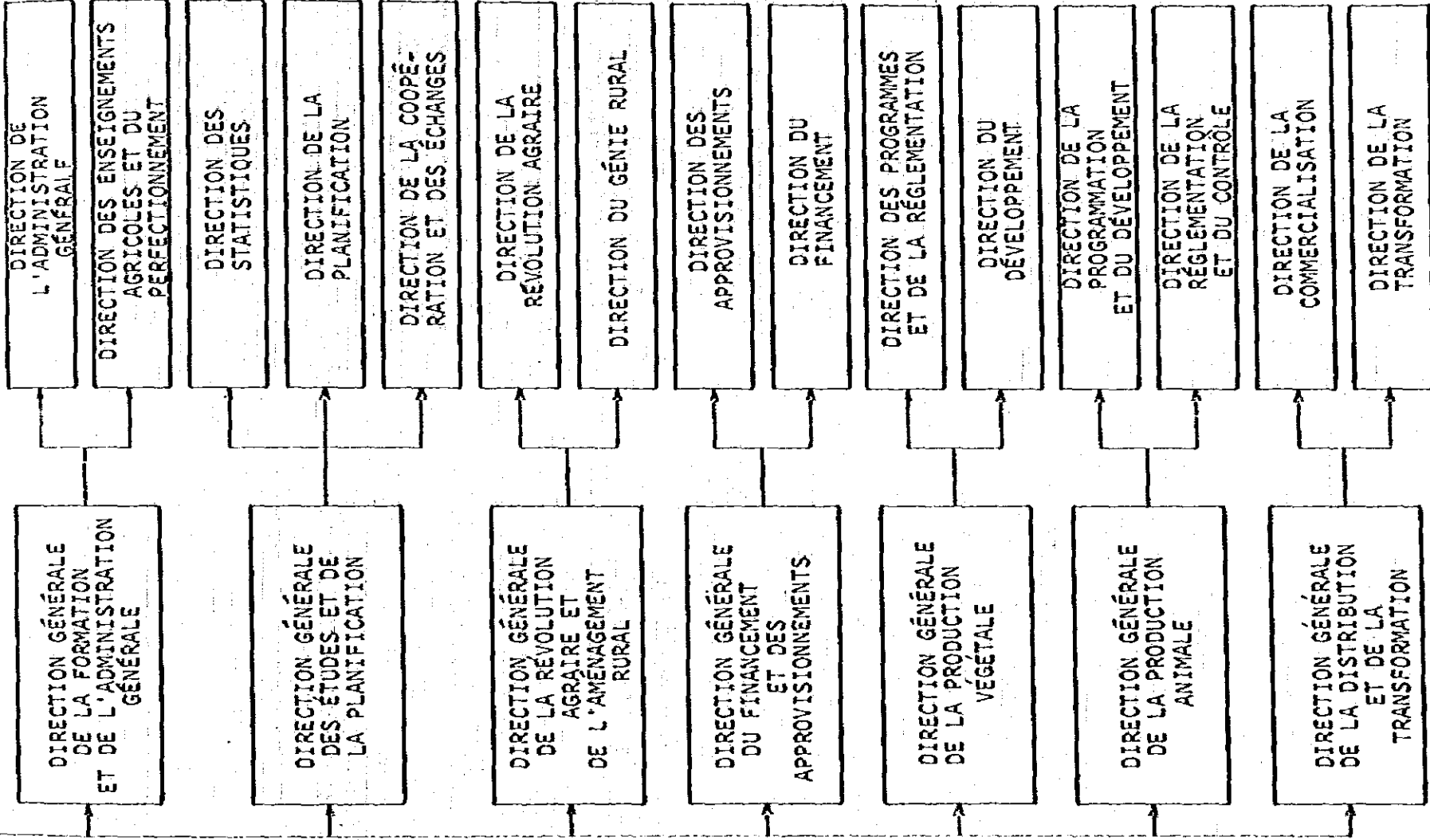

商 業 省 組 織 図

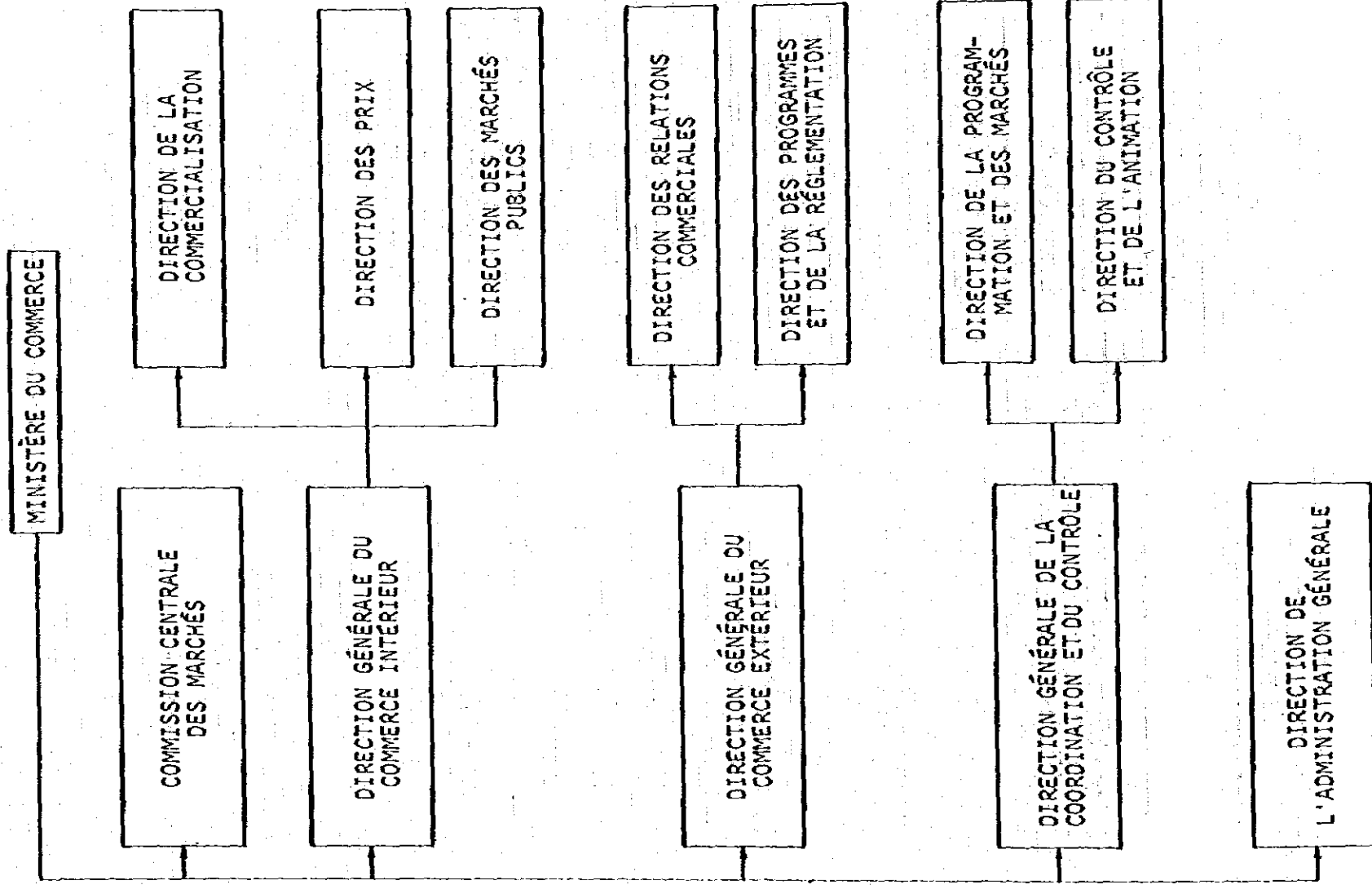

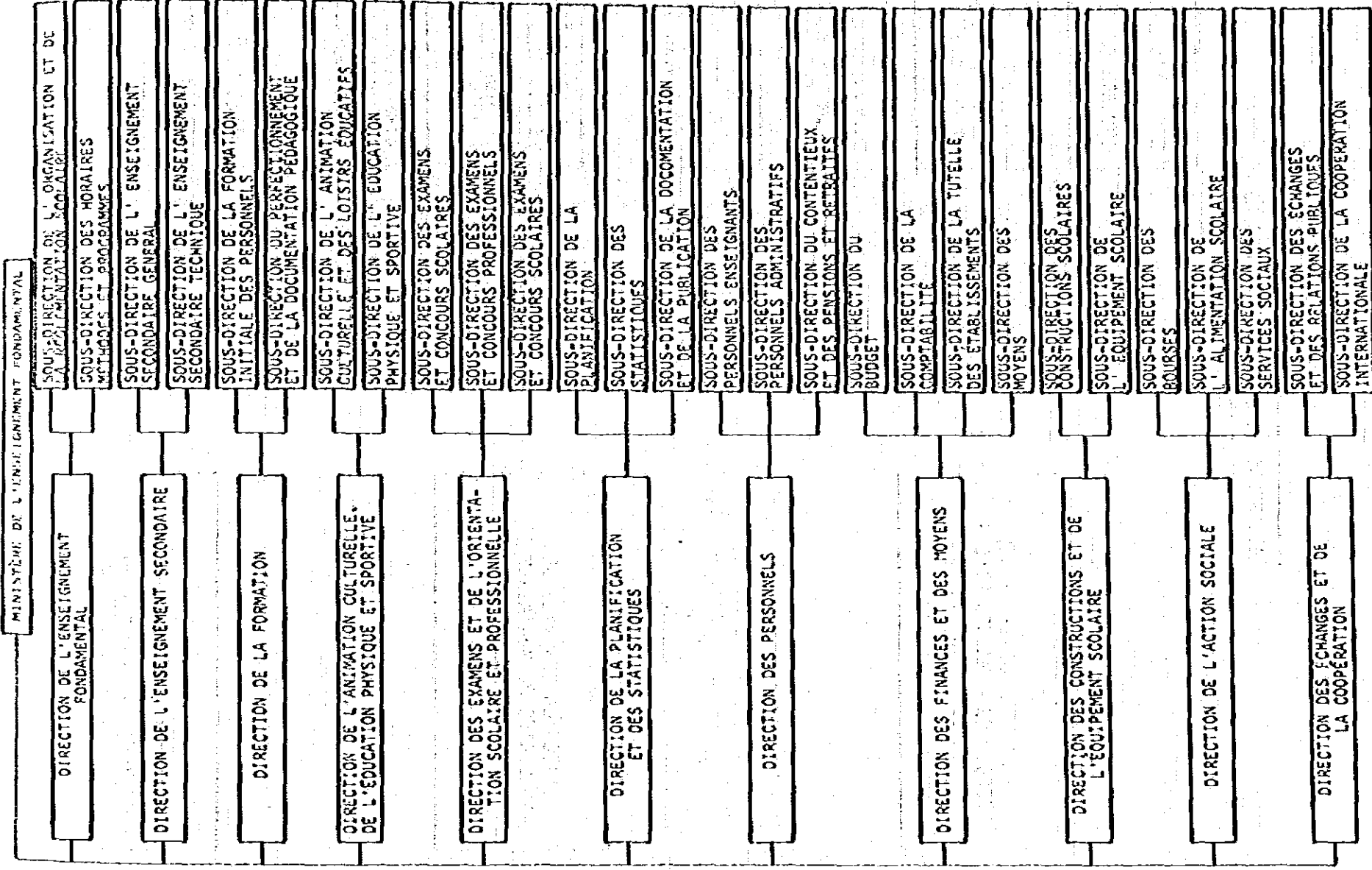

輕 工 業 省 級 概 圖

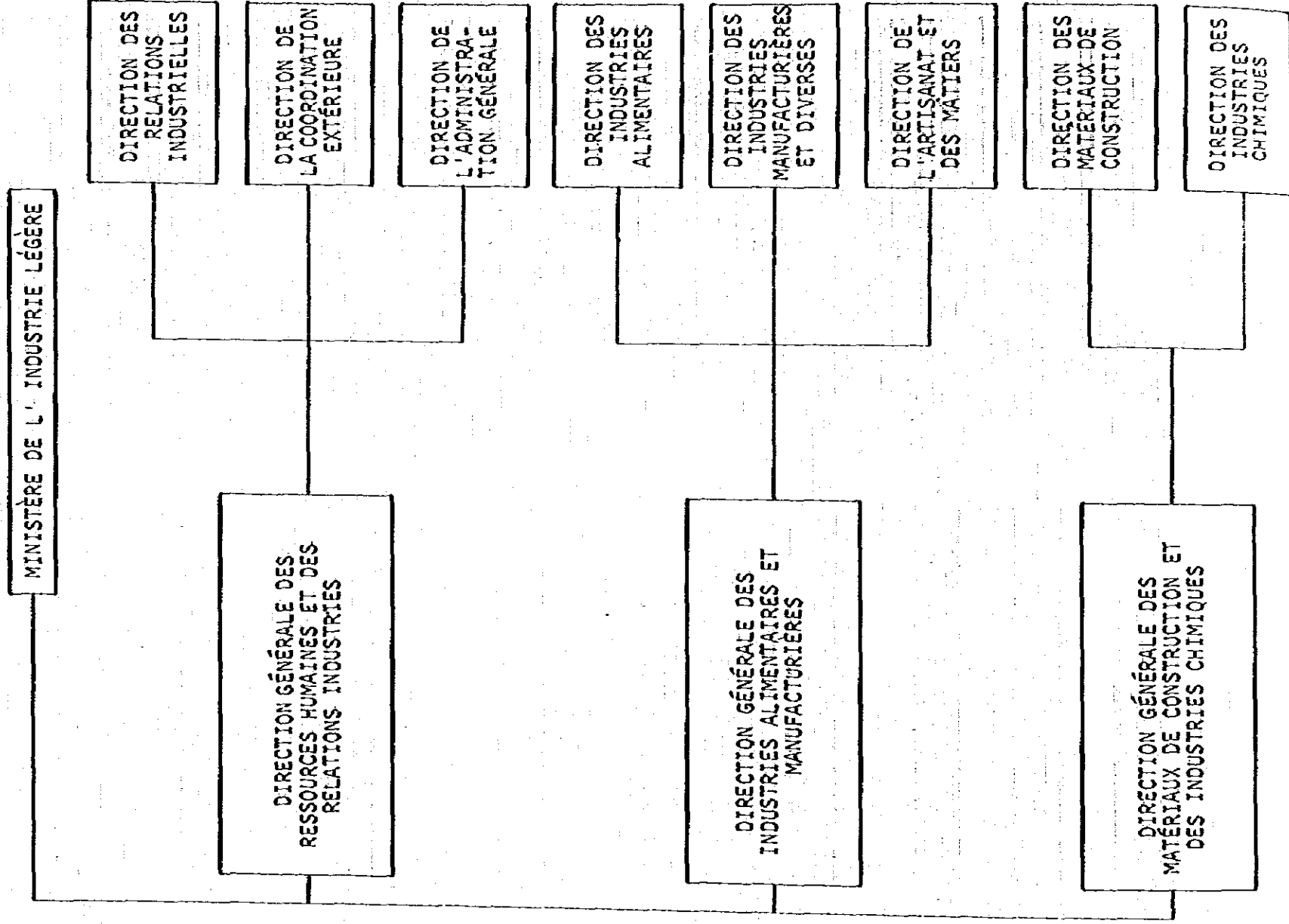

MINISTÈRE DE L'INDUSTRIE LOURDE

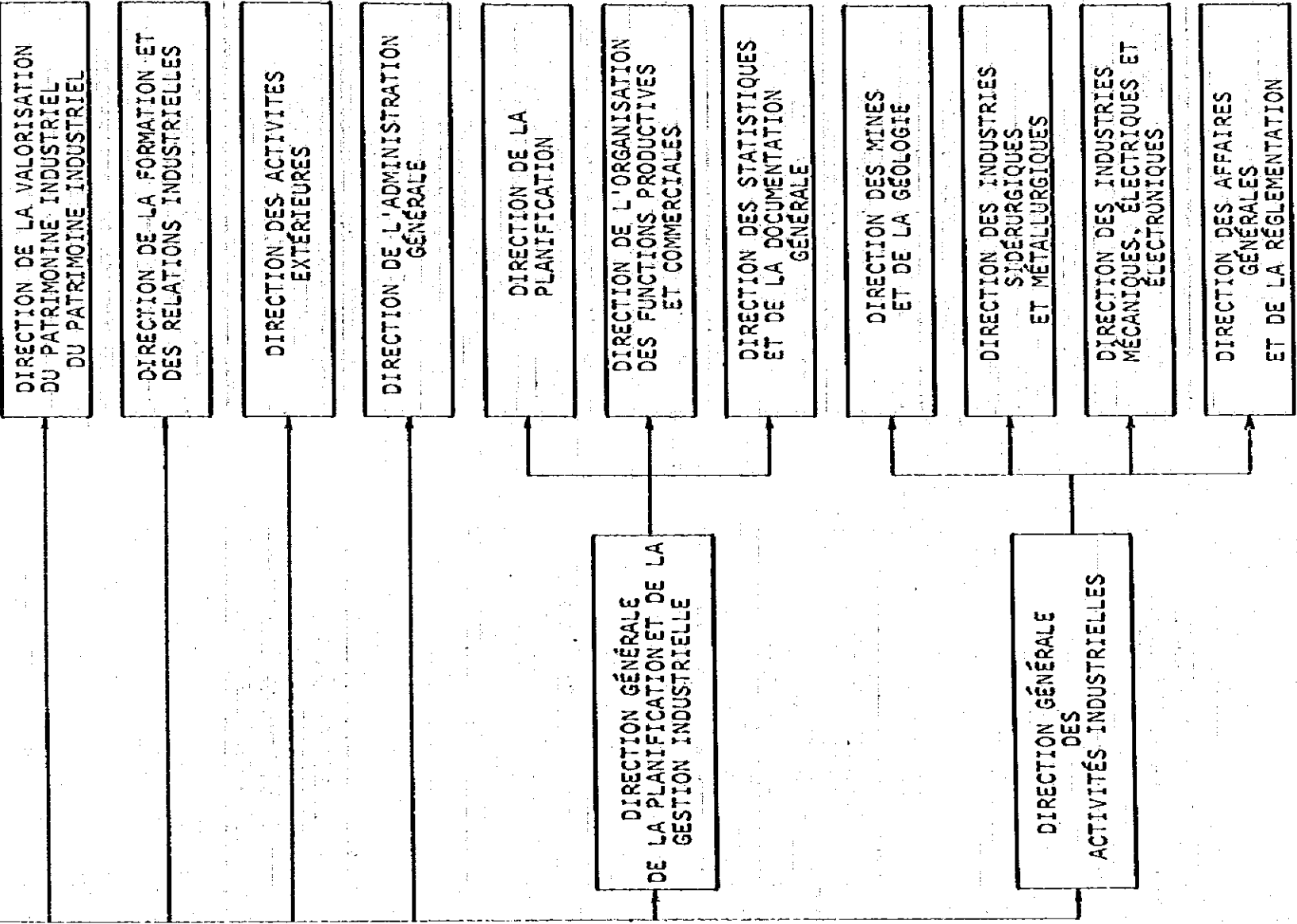

重工業省

アルジェリア

エネルギー・石油化学省組織図

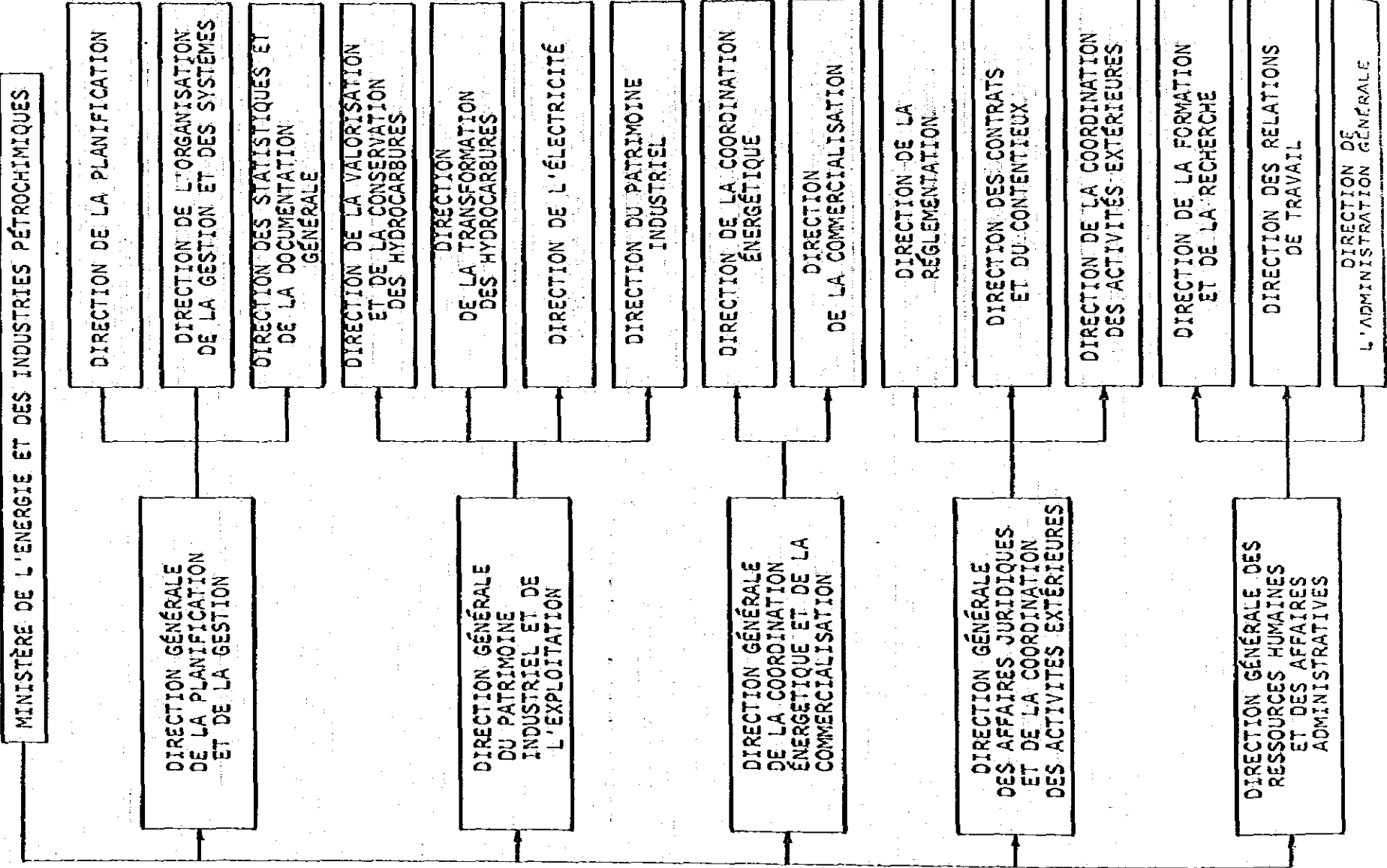

MINISTÈRE DE LA CONSTRUCTION

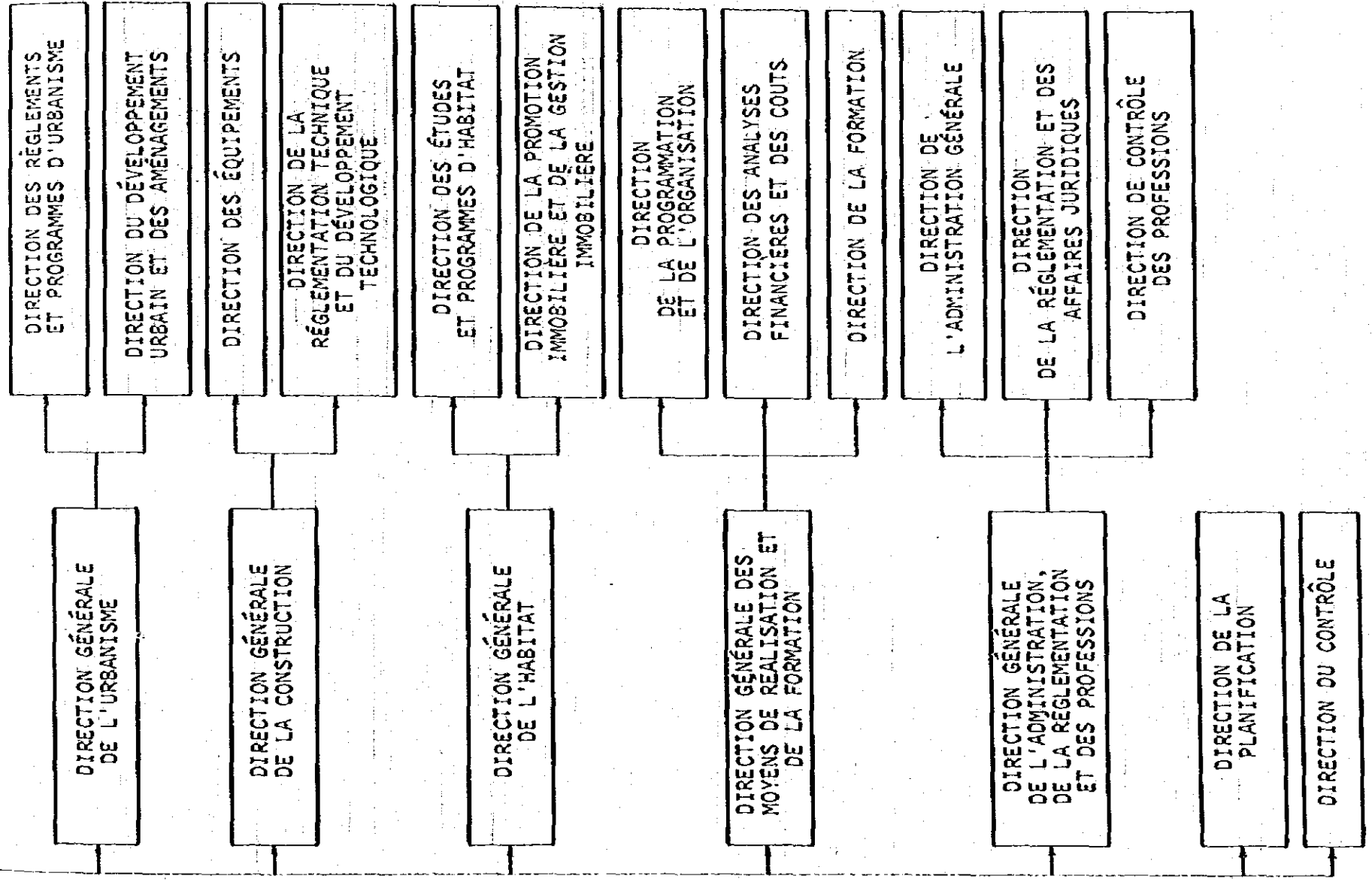

建設省

ア
ル
ジ
ェ
リ
ア

運輸省組織図

MINISTÈRE DES TRANSPORTS.

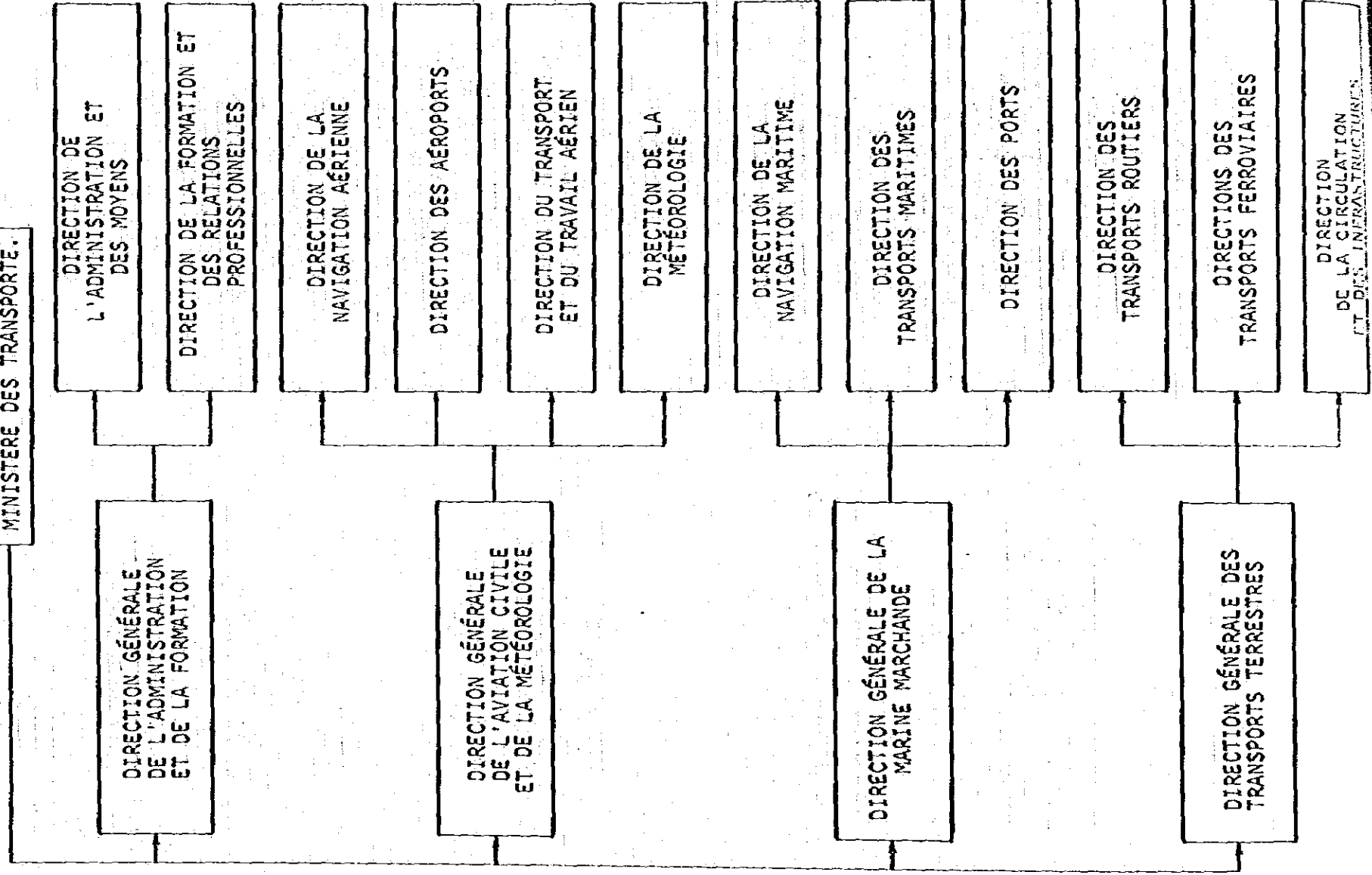

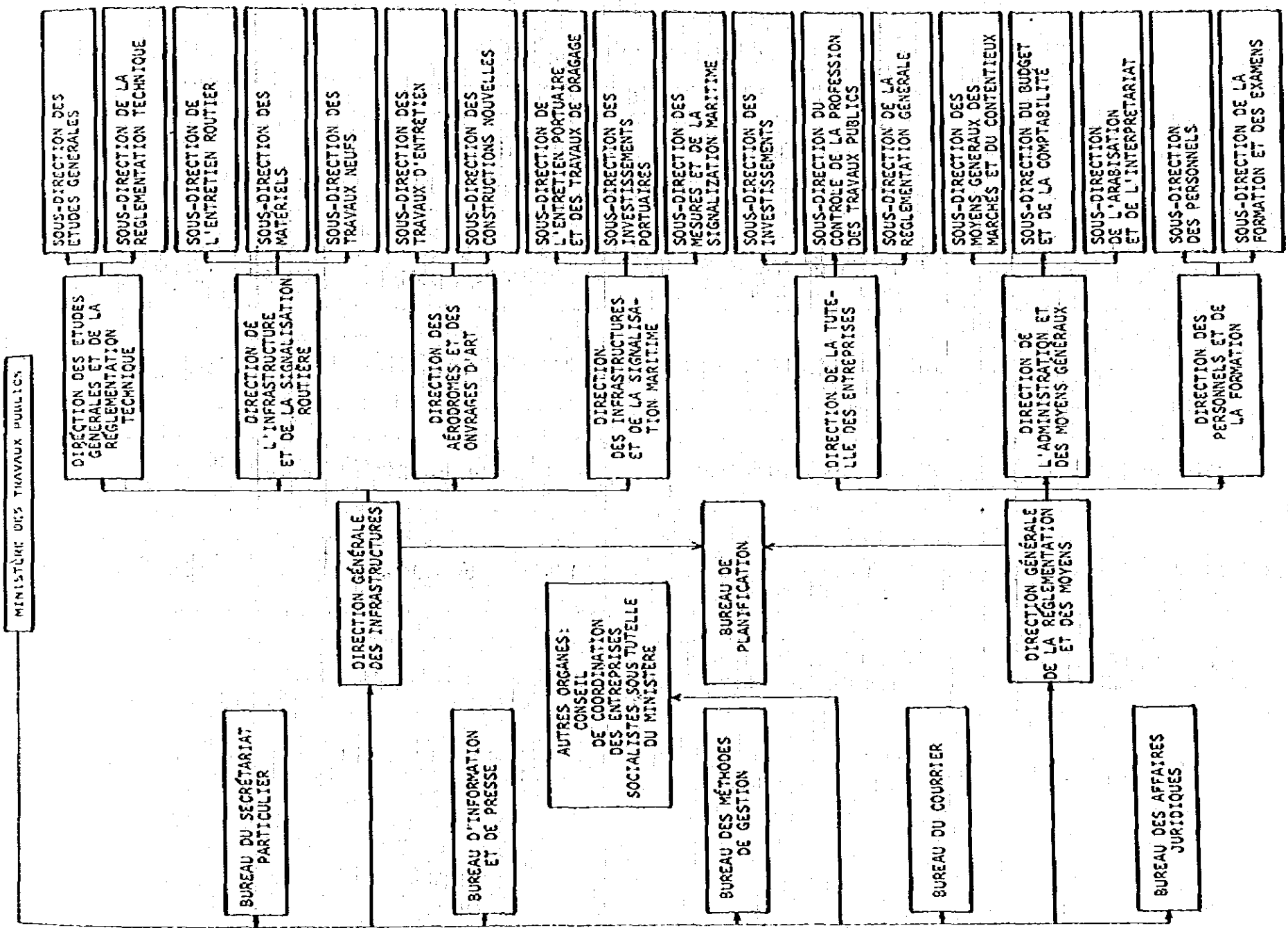

1 2 3 4 5 6 7 8 9 10 11 12 13 14 15 16 17 18

公共事業省

バーレーン国政府行政組織図

バーレーン

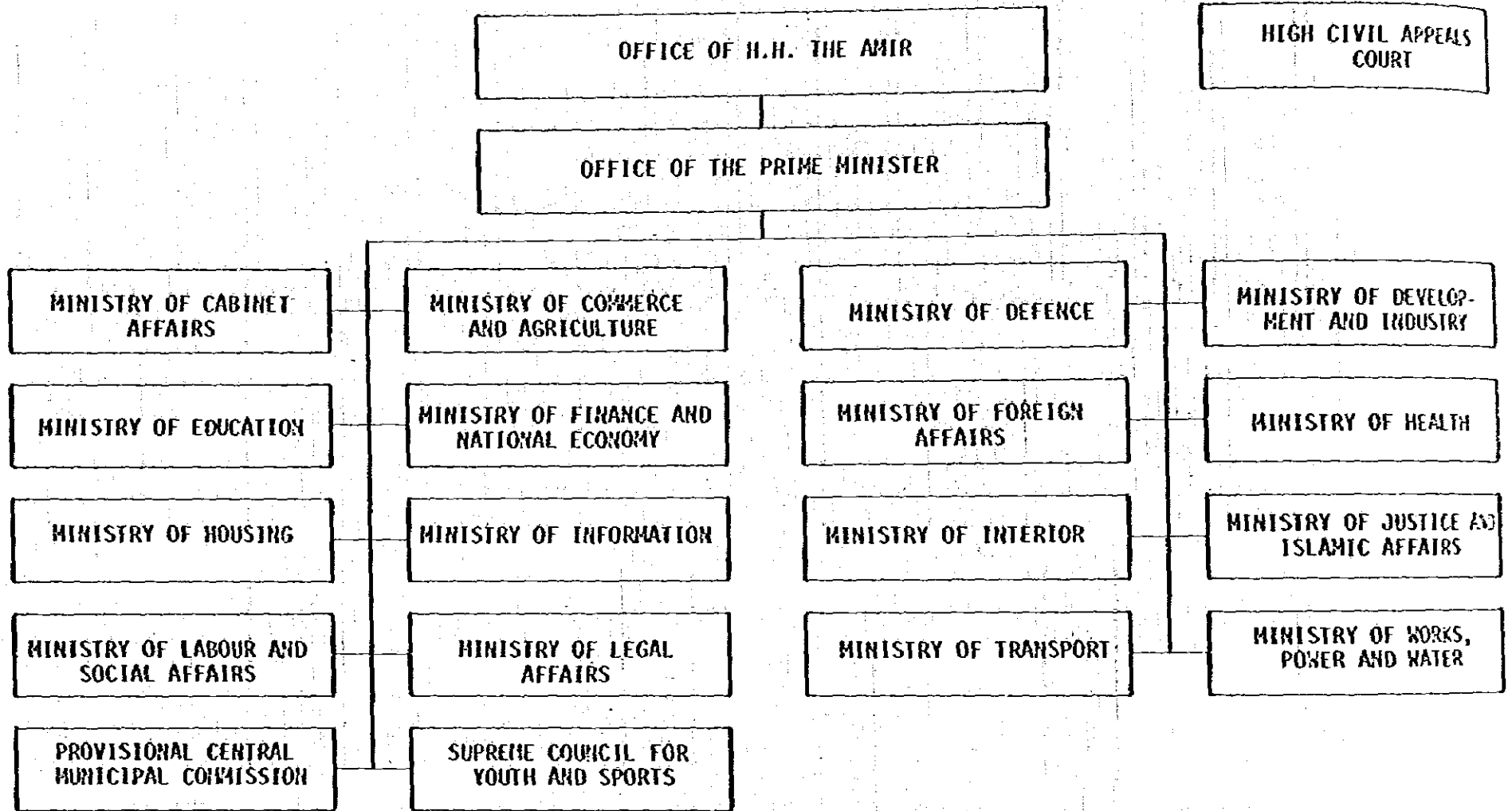

行政組織

エジプト国政府行政組織図

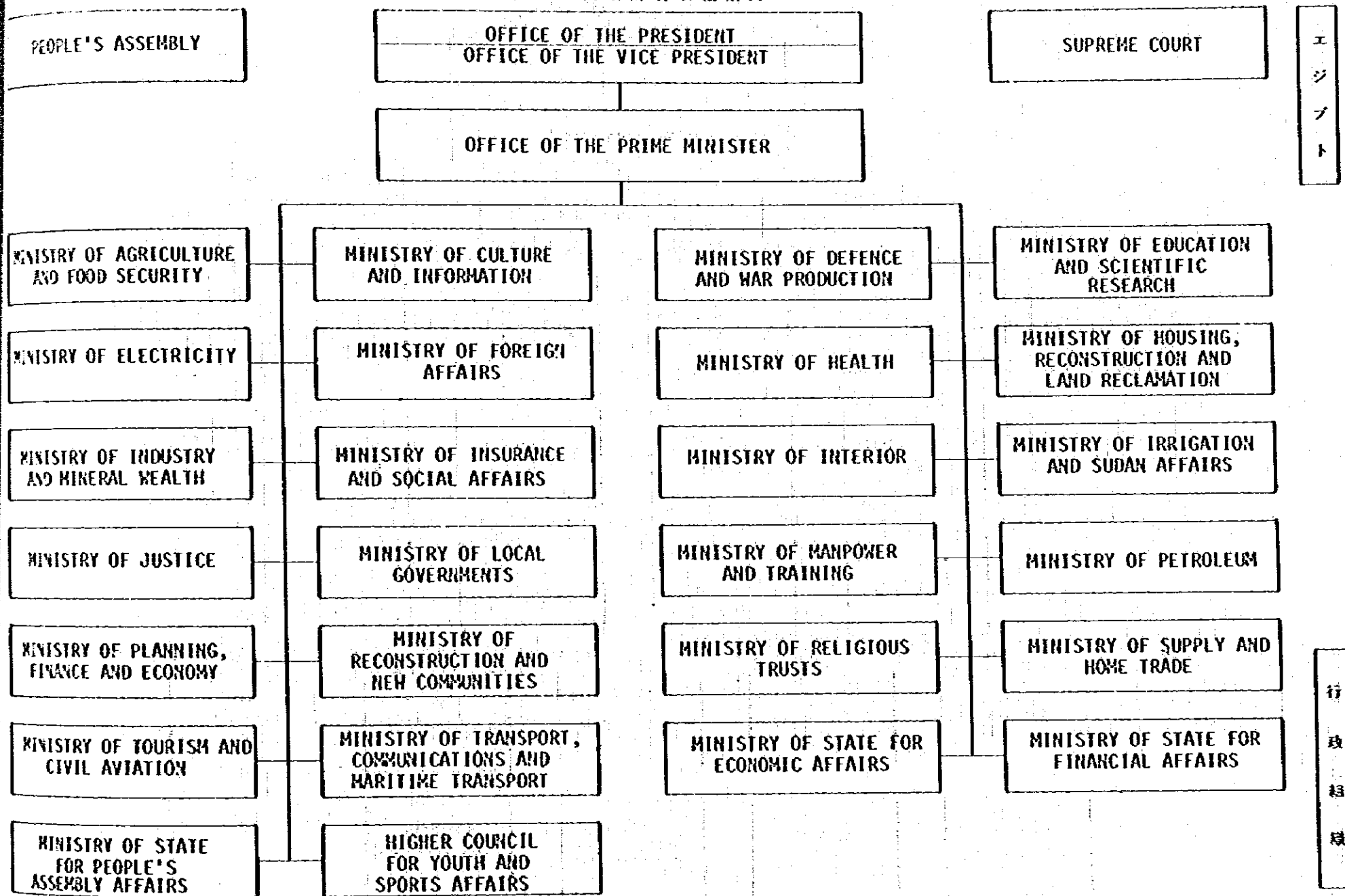

エ
ジ
プ
ト

行
政
組
織

農 業 省 組 織 図

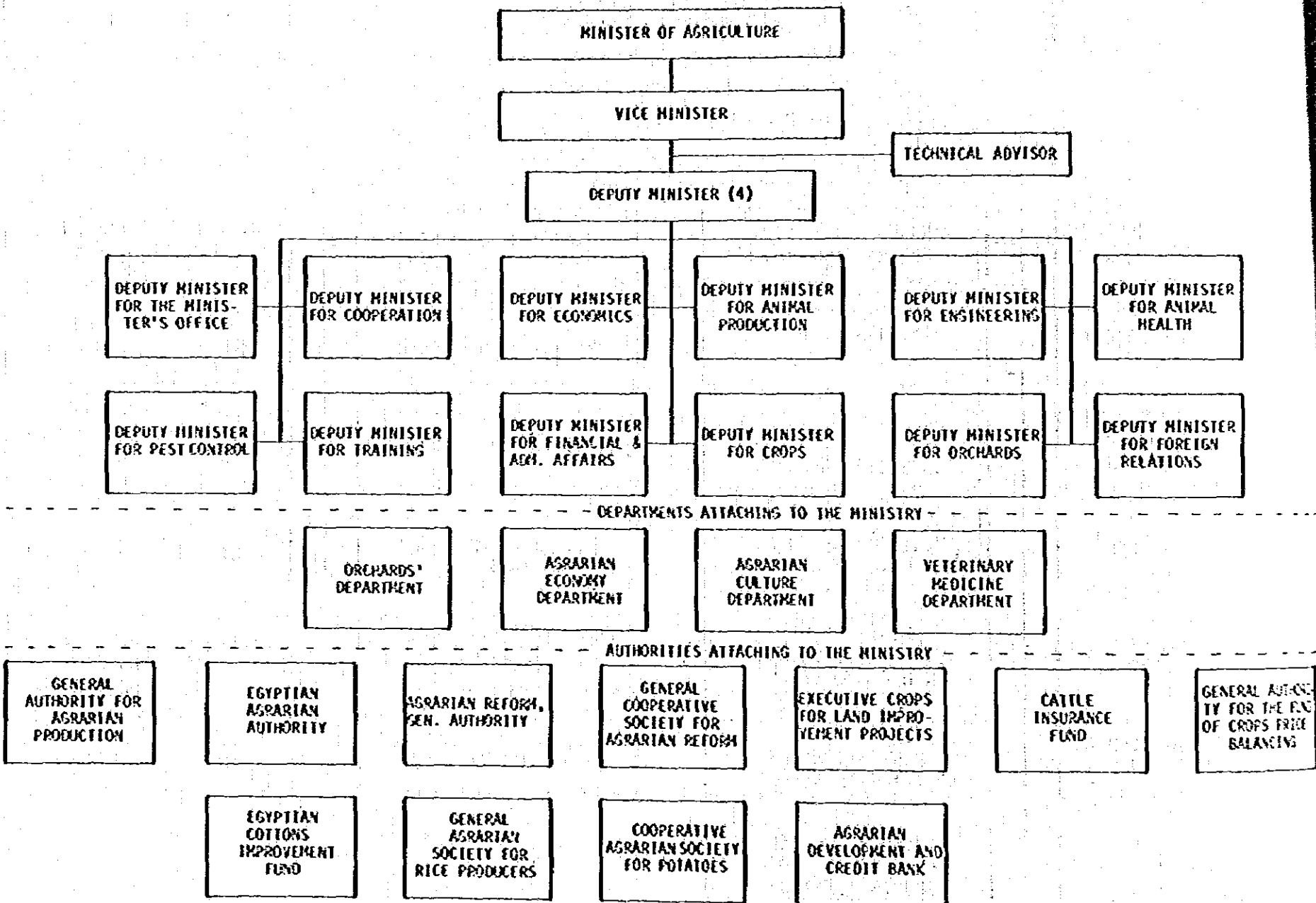

MINISTRY OF ELECTRICITY AND ENERGY

エ
ジ
プ
ト

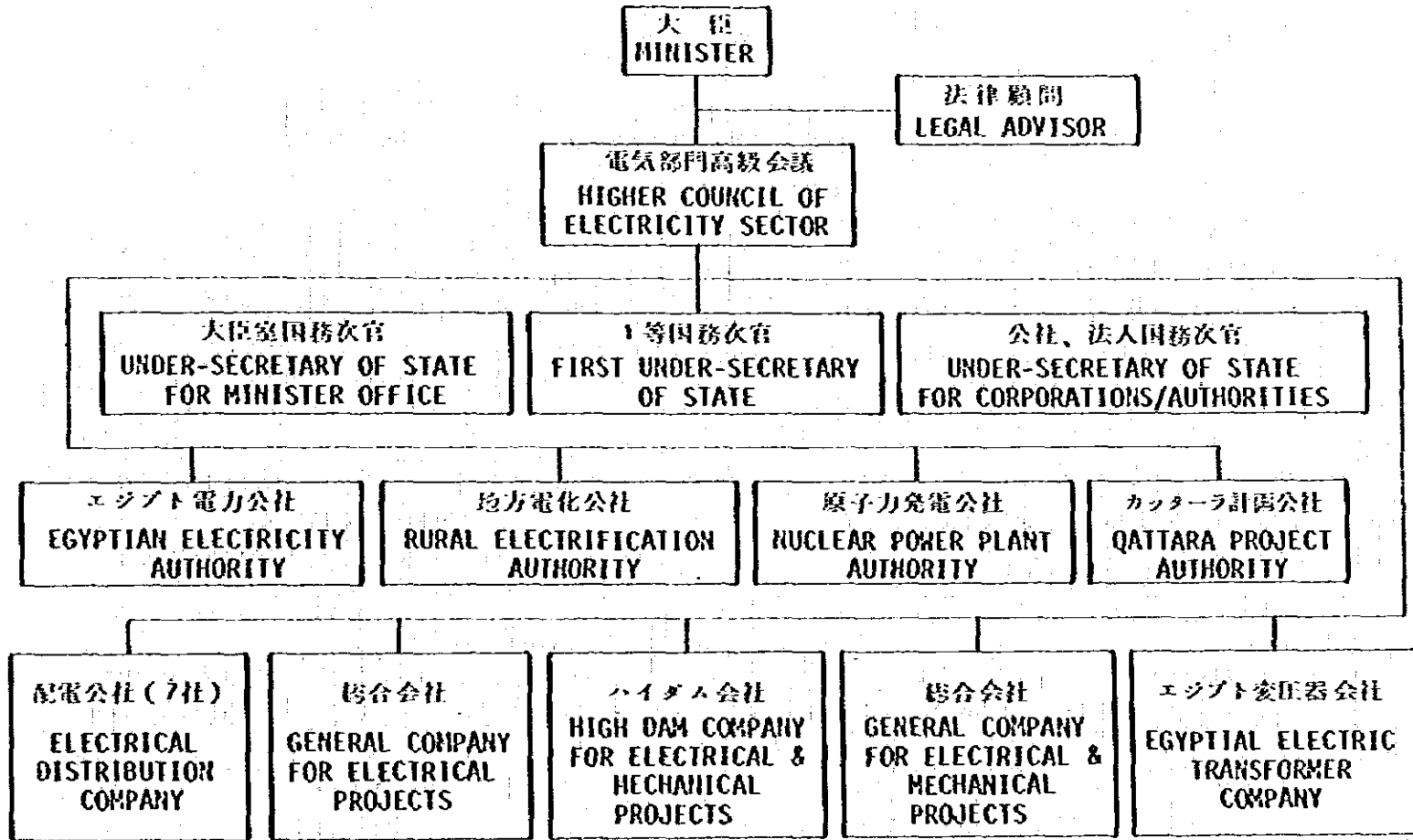

(CAIRO, ALEXANDRIA
DELTA, BEHEIRA, CANAL
MIDDLE EGYPT,
UPPER EGYPT)

電
気
エ
ネ
ル
ギ
ー
省

EGYPTIAN ELECTRICITY AUTHORITY

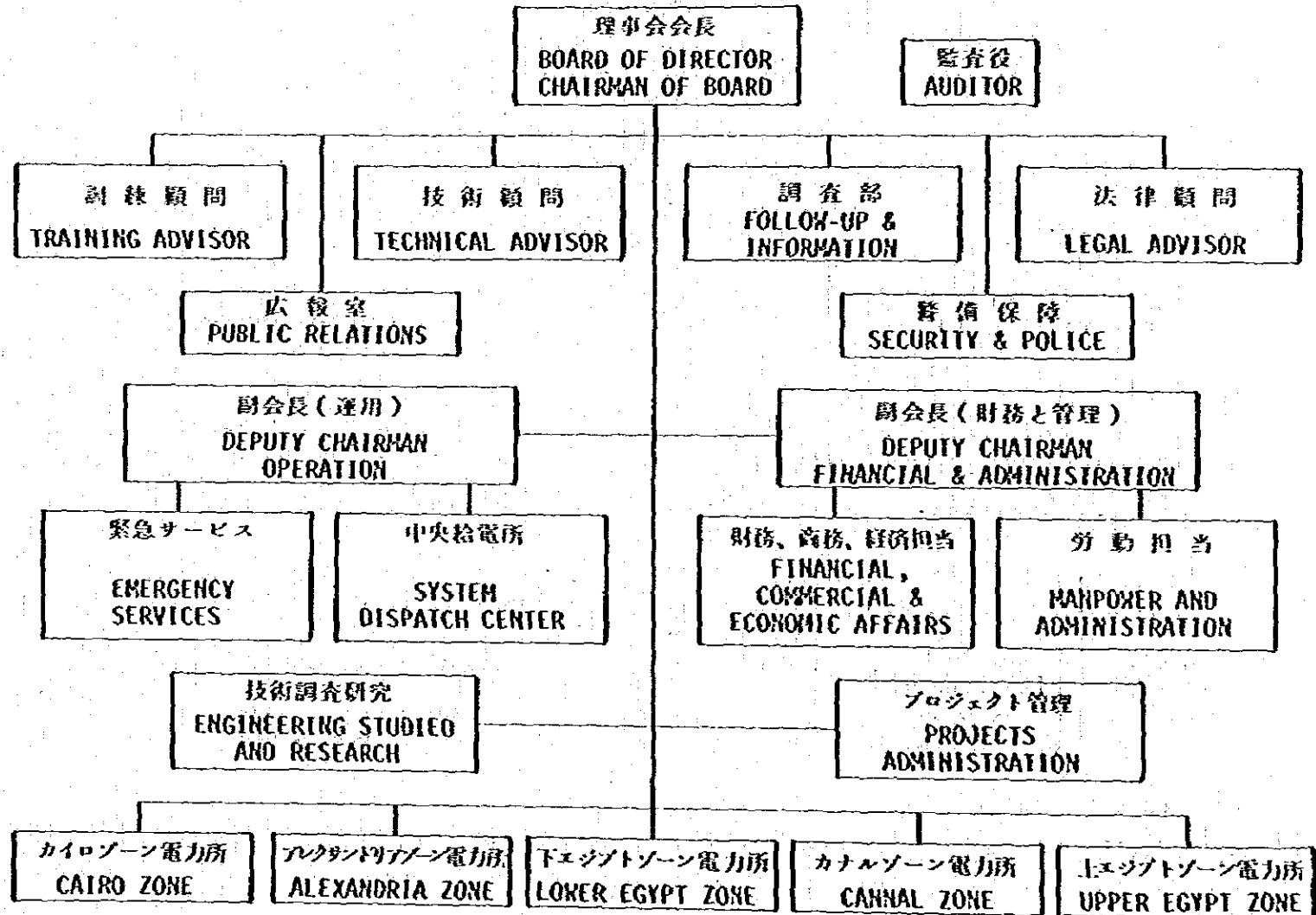

大 蔵 省 組 織 図

エ
ジ
プ
ト

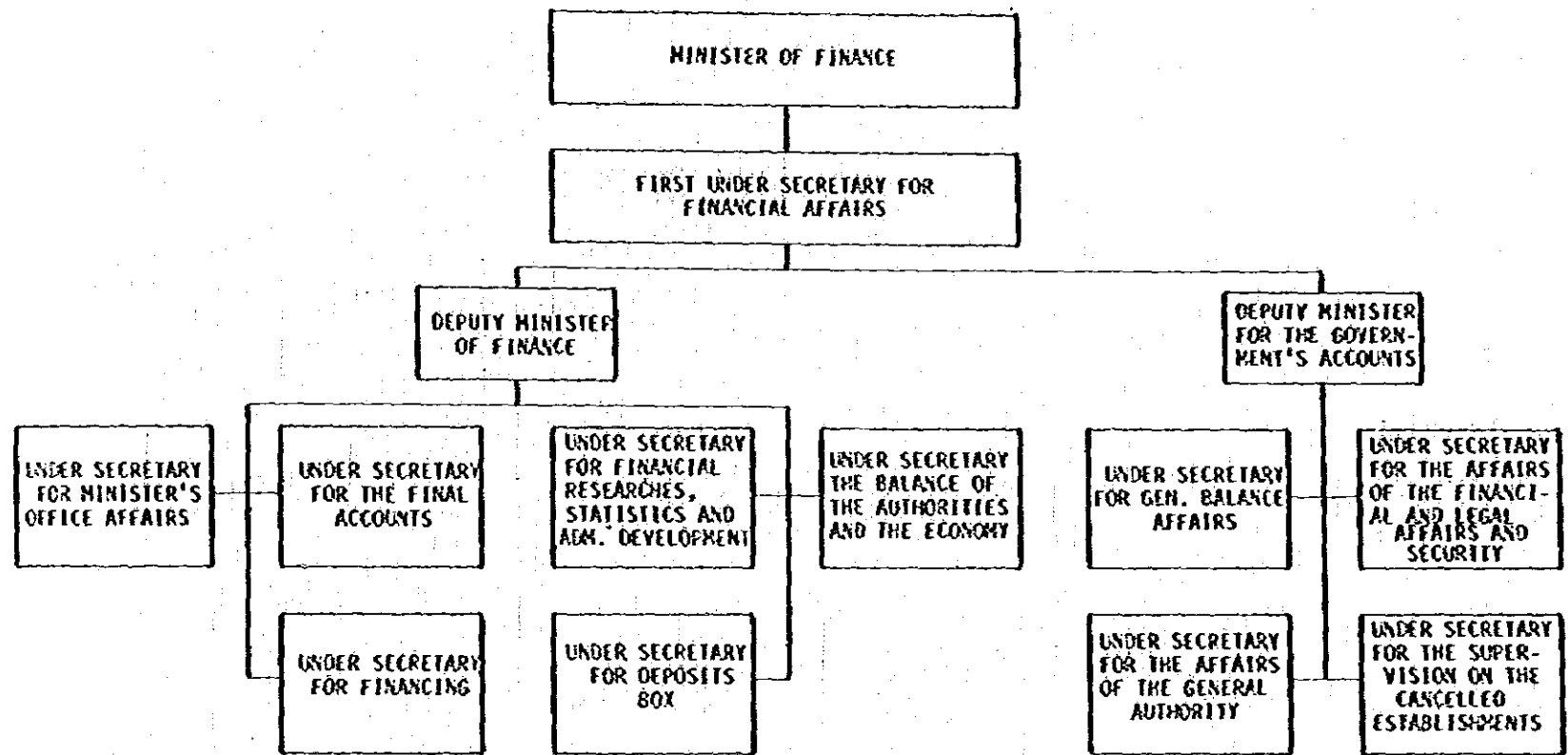

— AUTHORITIES & DEPARTMENTS AFFILIATED TO THE MINISTRY —



大
蔵
省

保 健 省 組 織 図

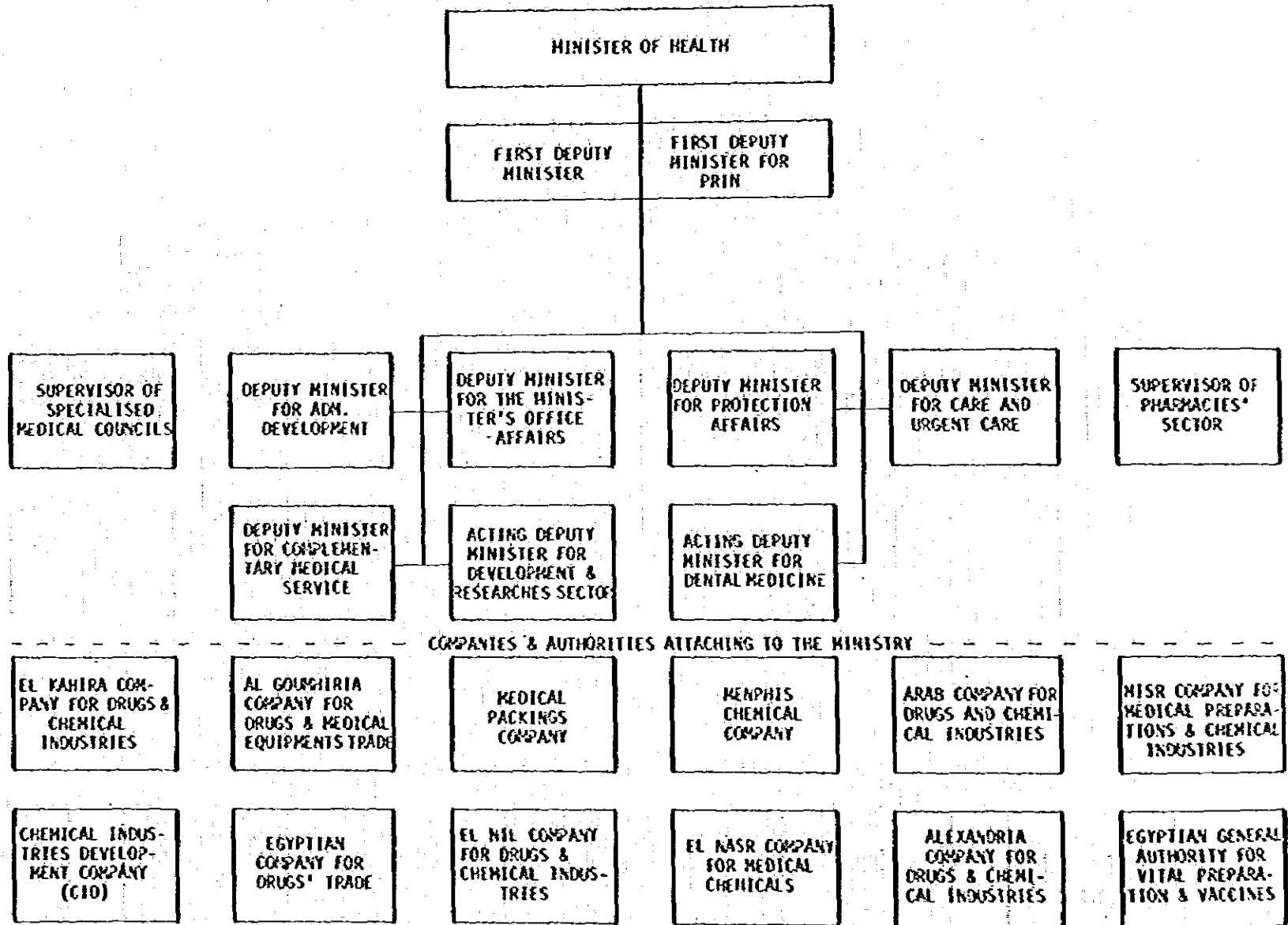

人力・職業訓練省組織図

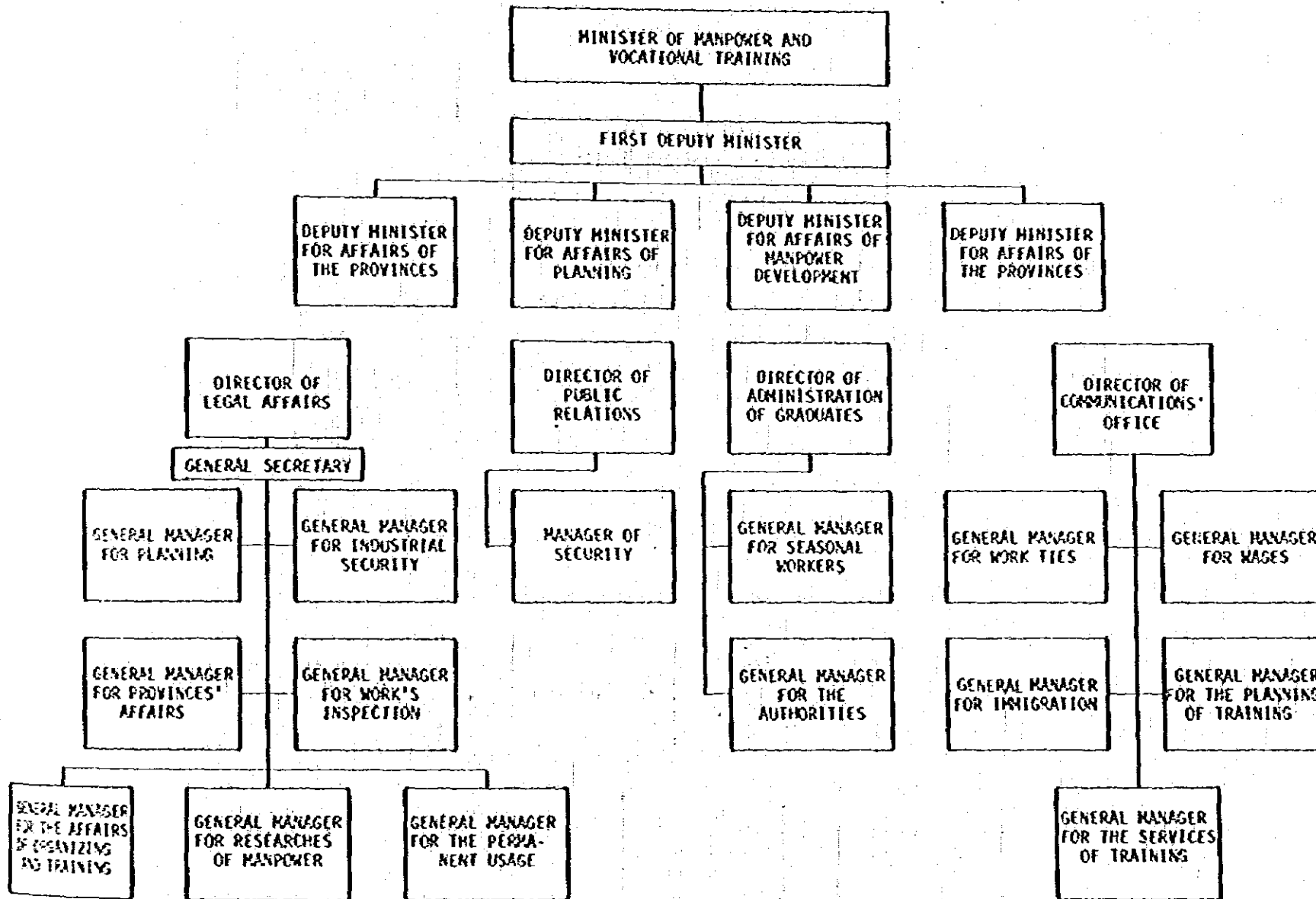

エ
ジ
ブ
ト

人
力
・
職
業
訓
練
省

海 運 省 組 織 図

エ
ジ
プ
ト

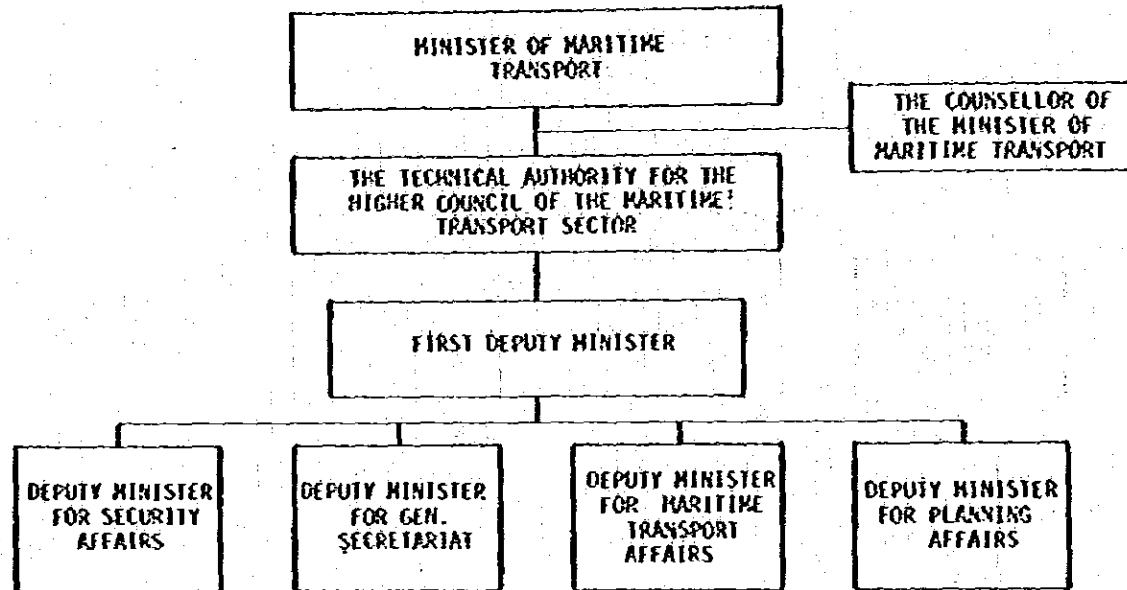

--- AUTHORITIES AND COMPANIES AFFILIATED TO THE MINISTRY ---

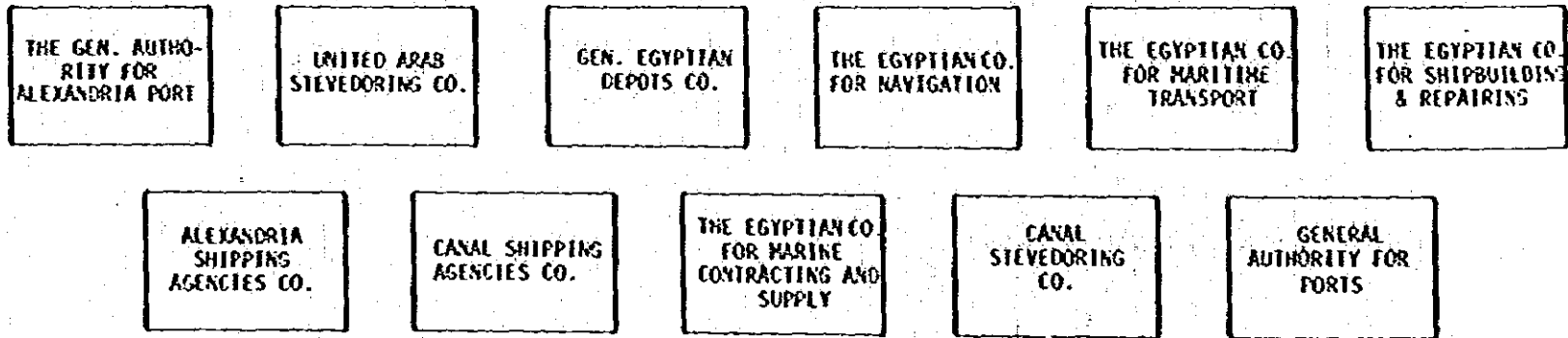

海
運
省

スエズ運河庁組織図

エ
ジ
プ
ト

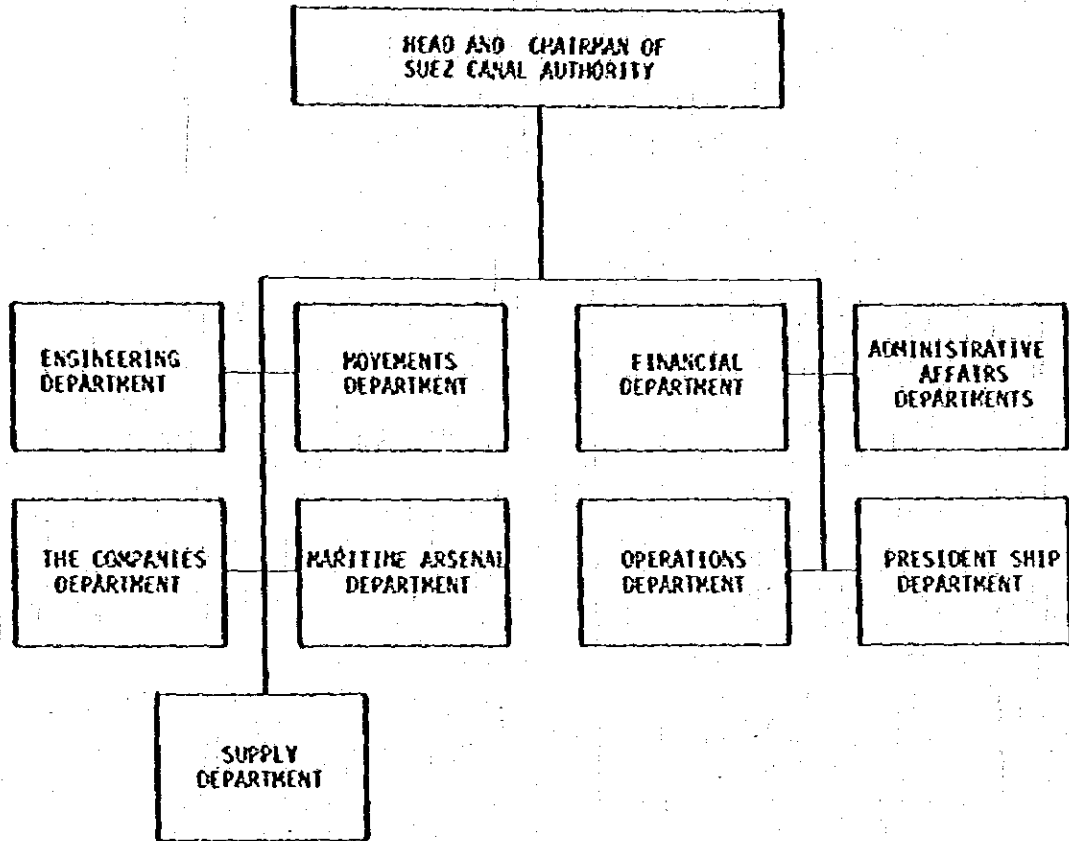

COMPANIES AFFILIATED TO THE AUTHORITY

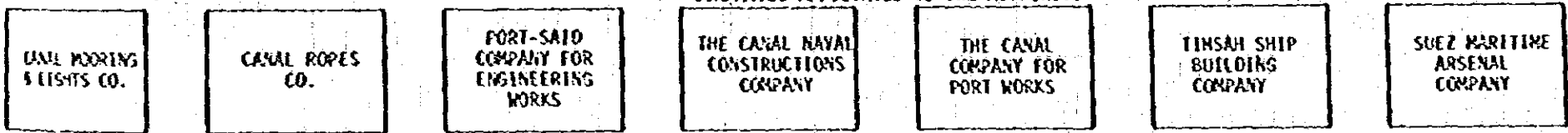

ス
エ
ズ
運
河
庁

イラン国政府行政組織図

イ
ラ
ン

(ISLAMIC CONSULTATIVE
ASSEMBLY) MAJLIS

OFFICE OF THE PRESIDENT

SUPREME COURT OF
APPEAL

OFFICE OF THE PRIME MINISTER

MINISTRY OF AGRICULTURE
AND RURAL DEVELOPMENT

MINISTRY OF COMMERCE

MINISTRY OF DEFENCE

MINISTRY OF ECONOMIC
AFFAIRS AND FINANCE

MINISTRY OF EDUCATION
AND TRAINING

MINISTRY OF ENERGY

MINISTRY OF FOREIGN
AFFAIRS

MINISTRY OF HEALTH

MINISTRY OF HOUSING AND
URBAN DEVELOPMENT

MINISTRY OF INDUSTRIES

MINISTRY OF INTERIOR

MINISTRY OF JUSTICE

MINISTRY OF LABOUR AND
SOCIAL AFFAIRS

MINISTRY OF NATIONAL
GUIDANCE

MINISTRY OF PETROLEUM

MINISTRY OF POST,
TELEGRAPH AND TELEPHONE

MINISTRY OF ROADS
AND TRANSPORT

MINISTRY OF SCIENCE
AND HIGHER EDUCATION

MINISTRY OF WELFARE

MINISTRY OF STATE FOR
ECONOMIC PLANNING

MINISTRY OF STATE FOR
EXECUTIVE AFFAIRS

MINISTRY OF STATE IN
CHARGE OF THE
STEEL COMPANY

行
政
組
織

OFFICE OF THE PRESIDENT OF THE REPUBLIC AND PRIME MINISTER

REVOLUTIONARY COMMAND COUNCIL

OFFICE OF THE VICE PRESIDENT

NATIONAL ASSEMBLY

OFFICE OF THE FIRST DEPUTY PRIME MINISTER

OFFICE OF THE DEPUTY PRIME MINISTER

OFFICE OF THE DEPUTY PRIME MINISTER AND MINISTER OF TRANSPORT AND COMMUNICATIONS

OFFICE OF THE DEPUTY PRIME MINISTER AND MINISTER OF DEFENCE

MINISTRY OF AGRICULTURE AND AGRARIAN REFORM

MINISTRY OF CULTURE AND INFORMATION

MINISTRY OF DEFENCE

MINISTRY OF EDUCATION

MINISTRY OF FINANCE

MINISTRY OF FOREIGN AFFAIRS

MINISTRY OF HEALTH

MINISTRY OF HIGHER EDUCATION AND SCIENTIFIC RESEARCH

MINISTRY OF HOUSING AND CONSTRUCTION

MINISTRY OF INDUSTRY AND MINERALS

MINISTRY OF INTERIOR

MINISTRY OF IRRIGATION

MINISTRY OF JUSTICE

MINISTRY OF LABOUR AND SOCIAL AFFAIRS

MINISTRY OF LOCAL ADMINISTRATION

MINISTRY OF PLANNING

MINISTRY OF OIL

MINISTRY OF RELIGIOUS ENDOWMENTS

MINISTRY OF TRADE

MINISTRY OF TRANSPORT AND COMMUNICATIONS

MINISTRY OF YOUTH AFFAIRS

(NATIONAL ASSEMBLY)

(SUPREME COURT)

ジ
ョ
ル
ダ
ン

SENATE NATIONAL CONSULTATIVE COUNCIL

OFFICE OF H.M. THE KING

COURT OF CASSATION

OFFICE OF THE PRIME MINISTER

MINISTRY OF AGRICULTURE

MINISTRY OF AQAF AND ISLAMIC AFFAIRS

MINISTRY OF COMMUNICATIONS

MINISTRY OF CULTURE AND YOUTH

MINISTRY OF DEFENCE

MINISTRY OF EDUCATION

MINISTRY OF FINANCE

MINISTRY OF FOREIGN AFFAIRS

MINISTRY OF HEALTH

MINISTRY OF INDUSTRY AND TRADE

MINISTRY OF INFORMATION

MINISTRY OF INTERIOR

MINISTRY OF JUSTICE

MINISTRY OF LABOUR

MINISTRY OF MUNICIPAL AND RURAL AFFAIRS AND ENVIRONMENT

MINISTRY OF OCCUPIED TERRITORIES AFFAIRS

MINISTRY OF PUBLIC WORKS

MINISTRY OF SOCIAL DEVELOPMENT

MINISTRY OF SUPPLY

MINISTRY OF TOURISM AND ANTIQUITIES

MINISTRY OF TRANSPORT

MINISTRY OF STATE FOR PRIME MINISTER AFFAIRS

行
政
組
織

クウェイト国政府行政組織図

ク
ウ
エ
イ
ト

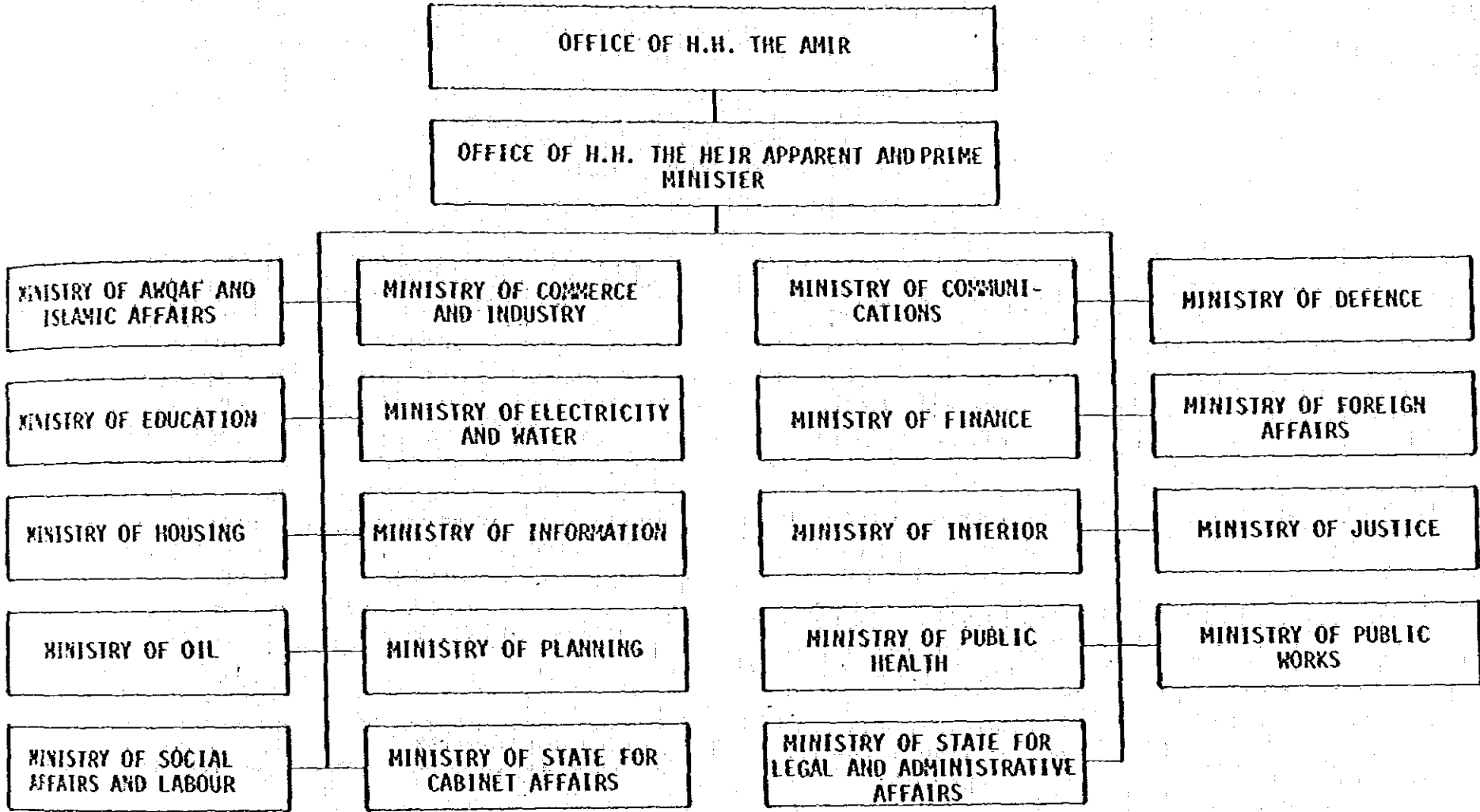

行
政
組
織

レバノン国政府行政組織図

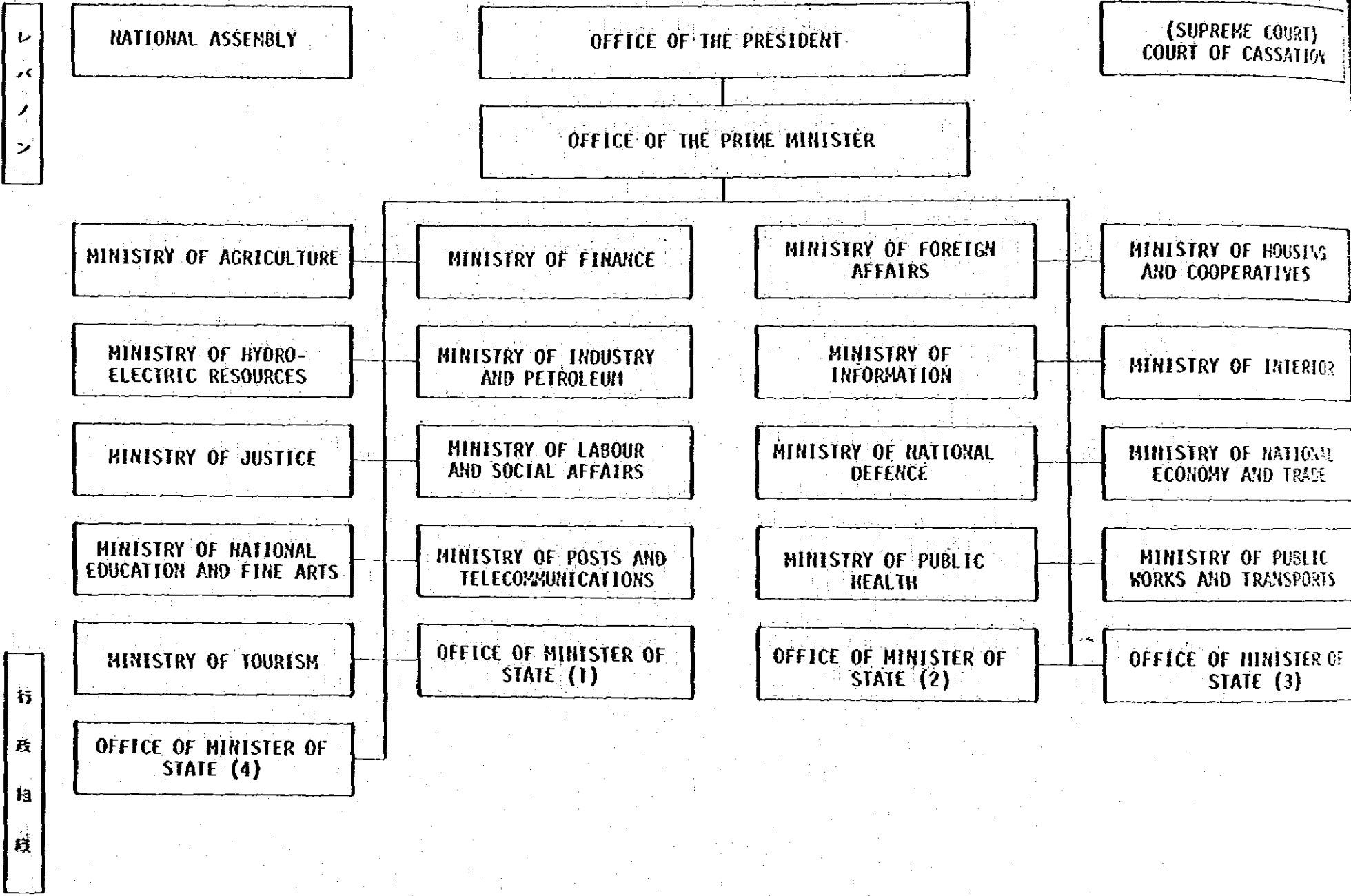

レ
バ
ノ
ン

行
政
組
織

CHAMBER OF REPRESENTATIVE

OFFICE OF H.M. THE KING

SUPREME COURT

モ
ロ
ク
コ

OFFICE OF THE PRIME MINISTER

MINISTRY OF ADMINISTRATIVE AFFAIRS

MINISTRY OF AGRICULTURE

MINISTRY OF COMMERCE AND INDUSTRY

MINISTRY OF ENERGY AND MINING RESEARCH

MINISTRY OF EQUIPMENT AND NATIONAL PROMOTION

MINISTRY OF FINANCE

MINISTRY OF HOUSING AND REGIONAL PLANNING

MINISTRY OF INFORMATION

MINISTRY OF INTERIOR

MINISTRY OF JUSTICE

MINISTRY OF LABOUR AND PROFESSIONAL TRAINING

MINISTRY OF NATIONAL EDUCATION AND CADRE TRAINING

MINISTRY OF PUBLIC HEALTH

MINISTRY OF RELATIONS WITH PARLIAMENT

MINISTRY OF RELIGIOUS ENDOWMENT AND ISLAMIC AFFAIRS

MINISTRY OF SOCIAL AFFAIRS AND HANDICRAFTS

MINISTRY OF TRANSPORTATION

MINISTRY OF YOUTH AND SPORTS

MINISTRY OF STATE IN CHARGE OF CULTURAL AFFAIRS

MINISTRY OF STATE IN CHARGE OF FOREIGN AFFAIRS AND COOPERATION

MINISTRY OF STATE IN CHARGE OF POSTAL SERVICE, TELEGRAPH AND TELEPHONE

MINISTRY OF STATE IN CHARGE OF TOURISM

GENERAL SECRETARIAT OF THE GOVERNMENT

OFFICE OF THE SECRETARY OF STATE ATTACHED TO THE PRIME MINISTER IN CHARGE OF PLANNING AND REGIONAL DEVELOPMENT

OFFICE OF THE SECRETARY OF STATE FOR CADRE TRAINING

OFFICE OF THE SECRETARY OF STATE FOR HIGHER EDUCATION AND SCIENTIFIC RESEARCH

行
政
組
織

オマーン国政府行政組織図

オ
マ
ー
ン

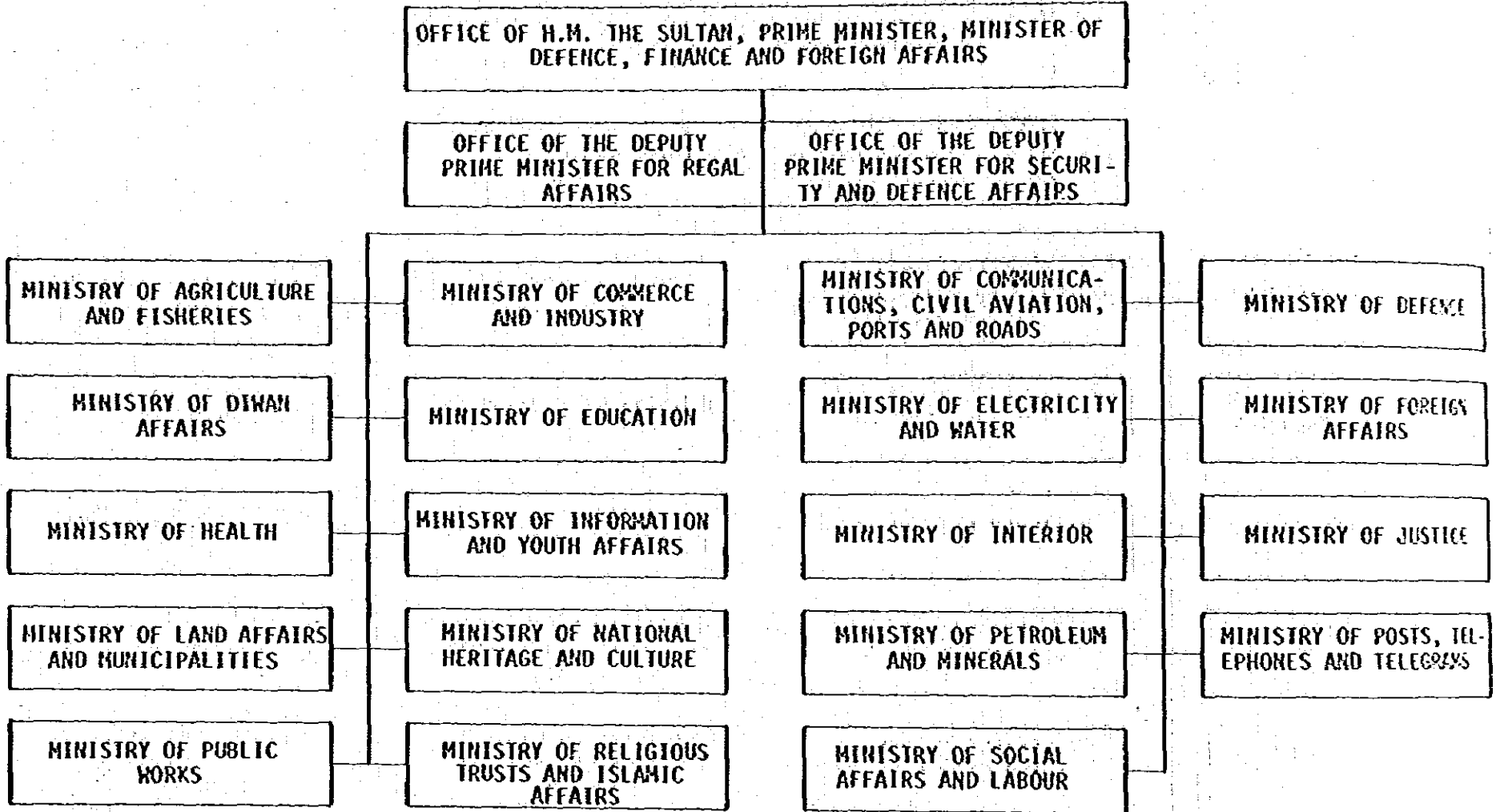

行
政
組
織

OFFICE OF H.H. THE AMIR AND PRIME MINISTER

MINISTRY OF AGRICULTURE AND INDUSTRY

MINISTRY OF COMMUNICATIONS AND TRANSPORT

MINISTRY OF DEFENCE AND OFFICE OF H.M. THE HEIR APPARENT

MINISTRY OF ECONOMIC AND COMMERCIAL AFFAIRS

MINISTRY OF EDUCATION

MINISTRY OF ELECTRICITY AND WATER

MINISTRY OF FINANCE AND PETROLEUM

MINISTRY OF FOREIGN AFFAIRS

MINISTRY OF INFORMATION

MINISTRY OF INTERIOR

MINISTRY OF JUSTICE

MINISTRY OF LABOUR AND SOCIAL AFFAIRS

MINISTRY OF MUNICIPAL AFFAIRS

MINISTRY OF PUBLIC HEALTH

MINISTRY OF PUBLIC WORKS

サウディ・アラビア国政府行政組織図

サウディ・アラビア

行政組織

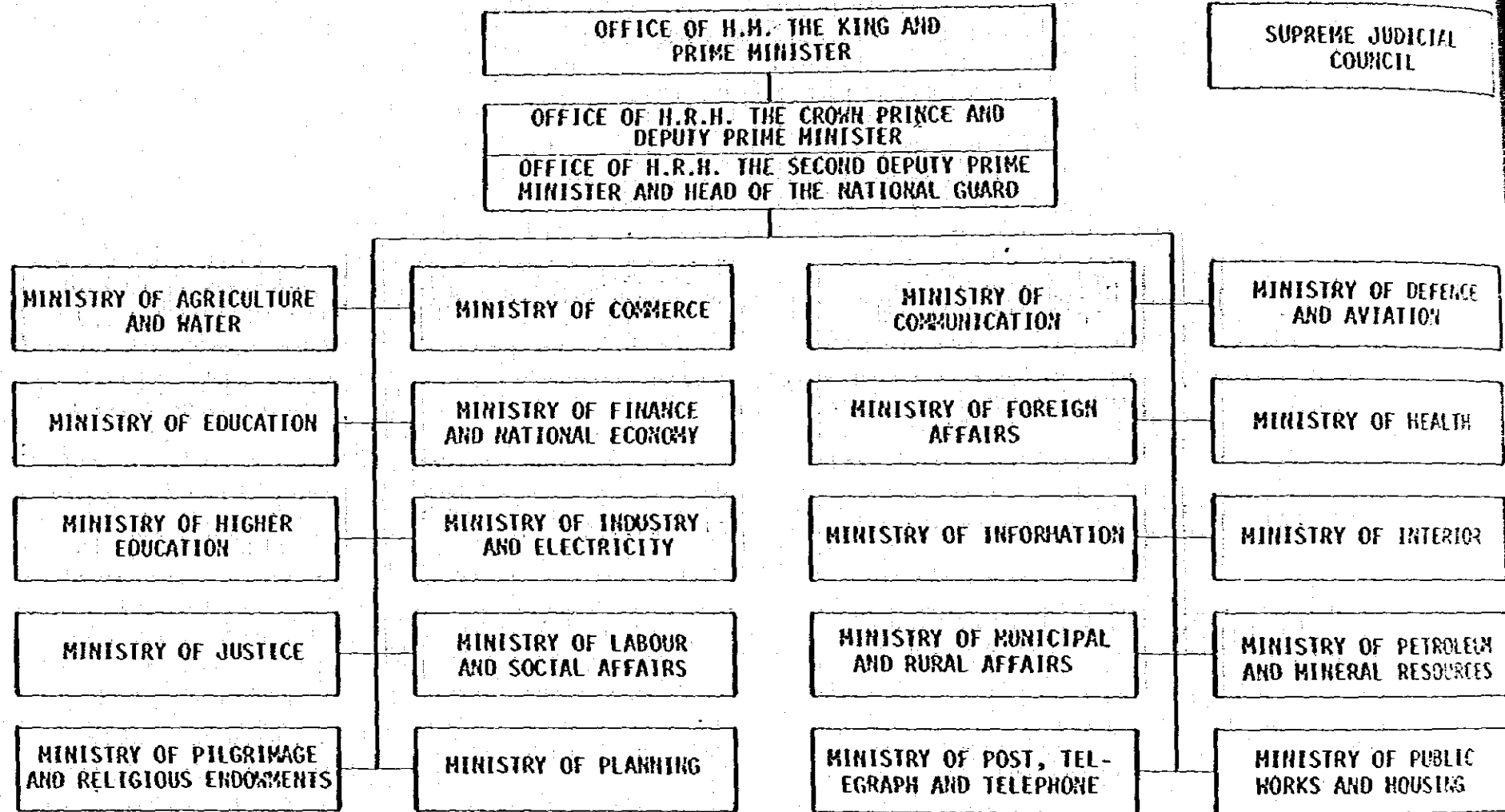

王室儀典局組織図

ROYAL PROTOCOL

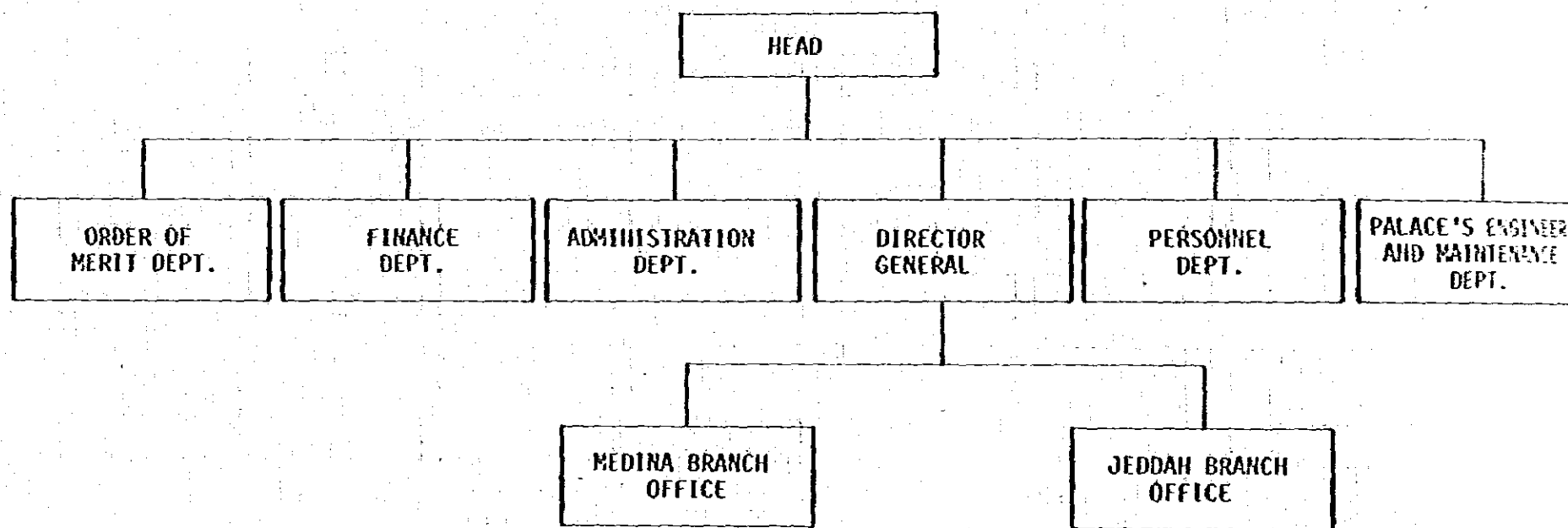

公共事業住宅省組織図
 MINISTRY OF PUBLIC WORKS & HOUSING

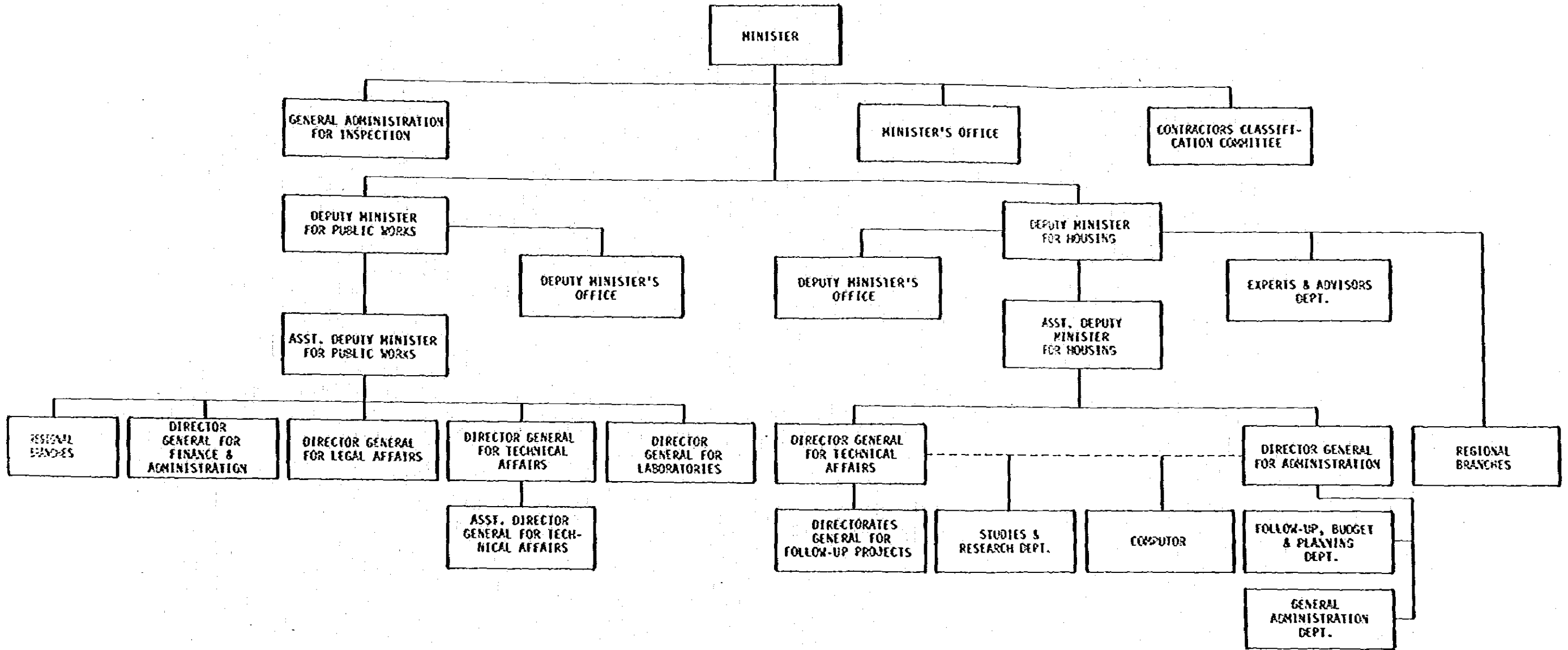

サウディ・アラビア

公共事業住宅省

外務省組織図
MINISTRY OF FOREIGN AFFAIRS

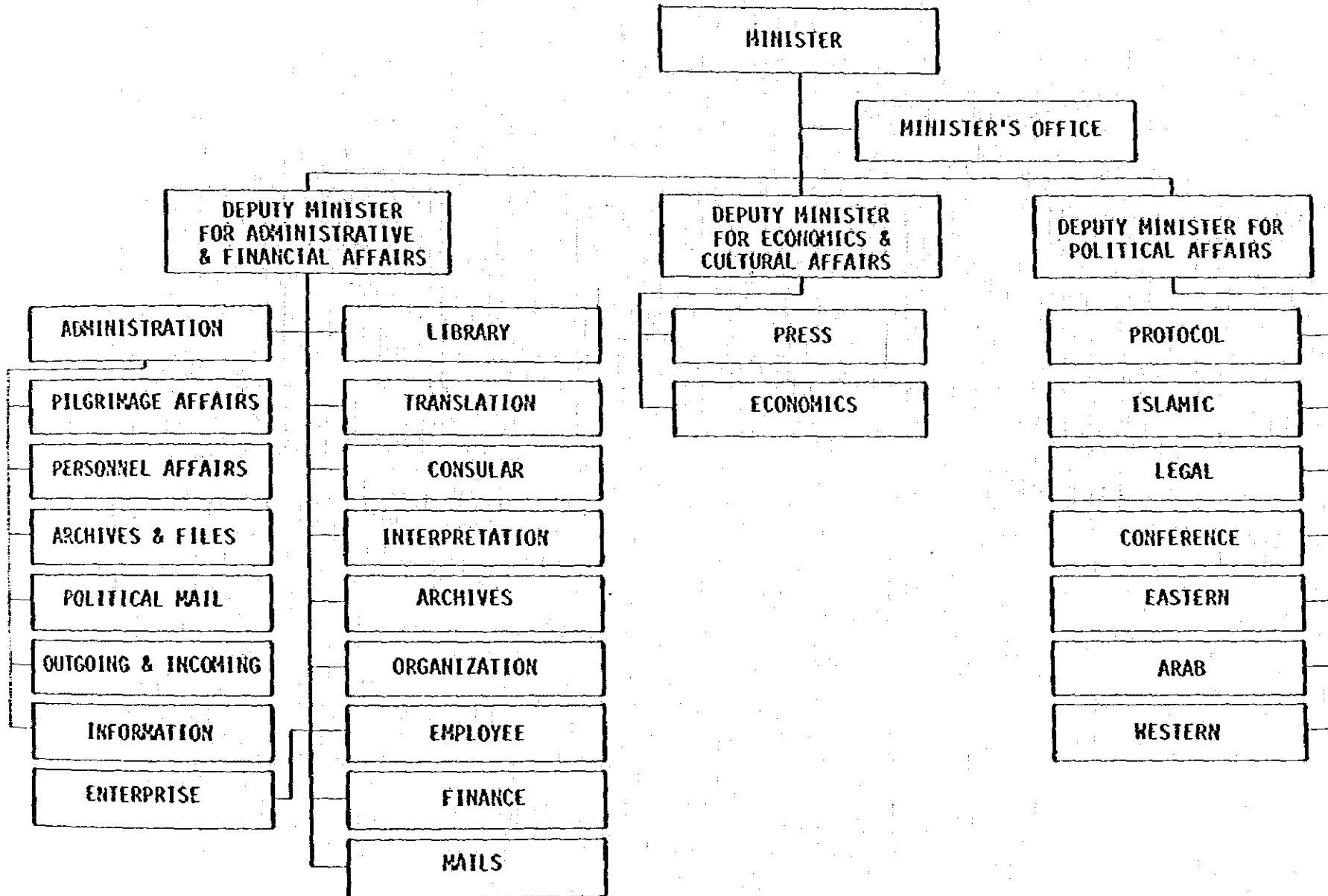

リウディ・アラビア

外務省

財政國家經濟省組織圖

MINISTRY OF FINANCE & NATIONAL ECONOMY

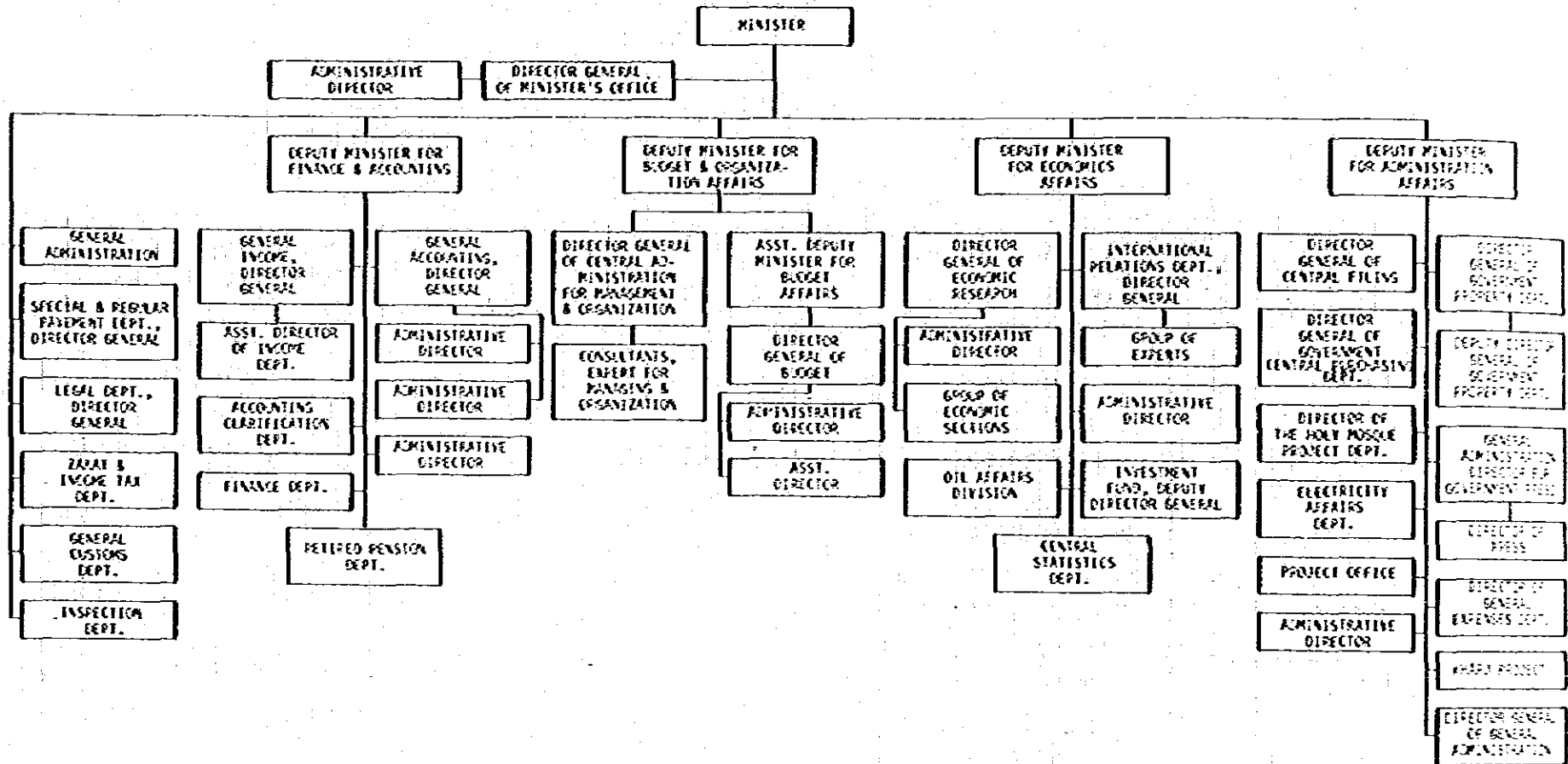

サウディ・アラビア

財政國家經濟省

CENTRAL STATISTICS DEPARTMENT

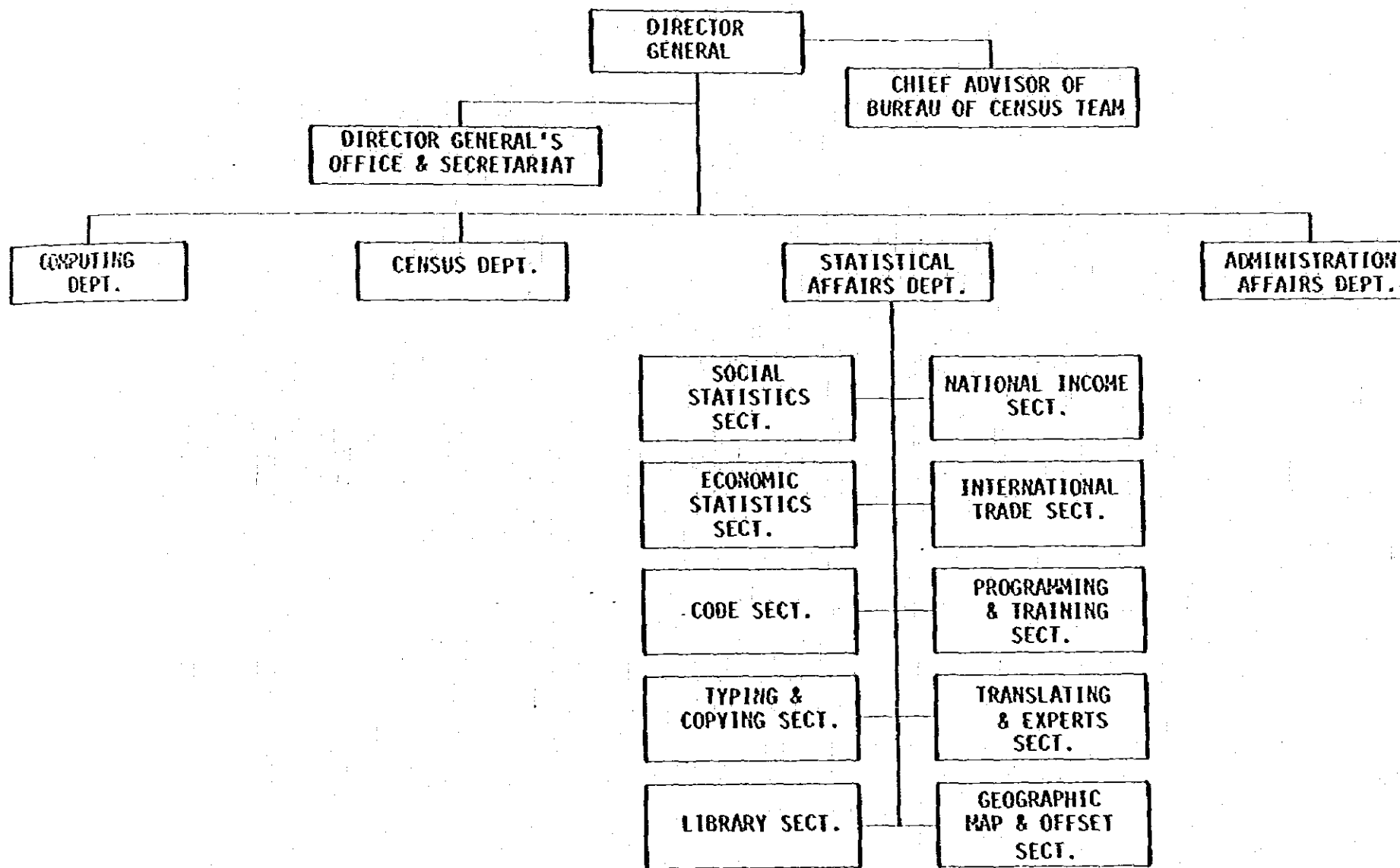

サウデー・アラビア

中
央
統
計
部

財政・国家経済省 Zakat 所得税部組織図

DEPARTMENT OF ZAKAT & INCOME TAX (DZIT)

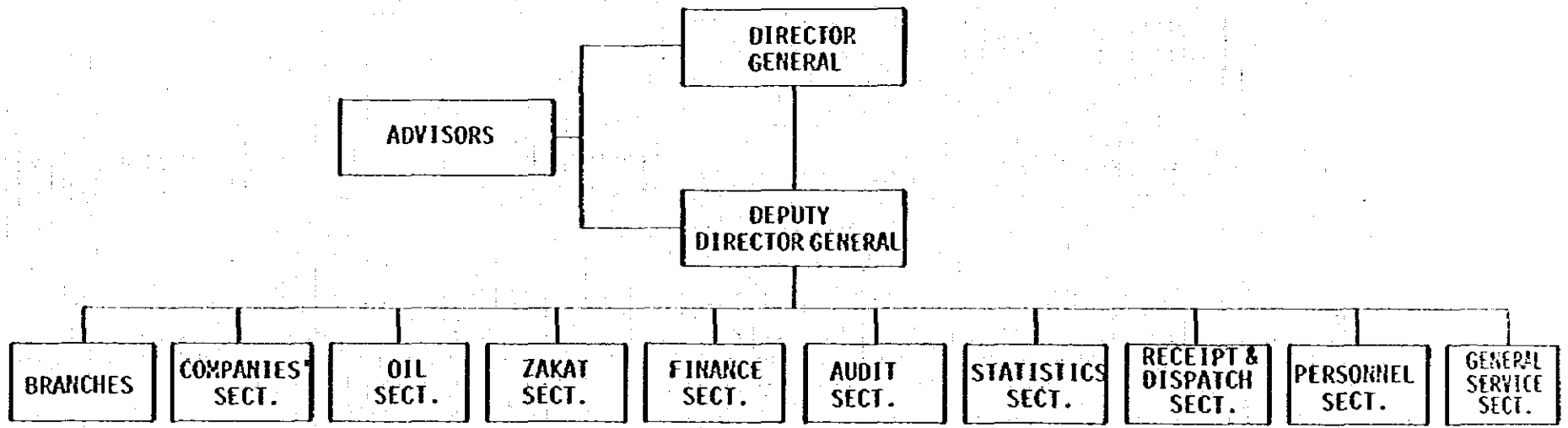

MINISTRY OF PLANNING

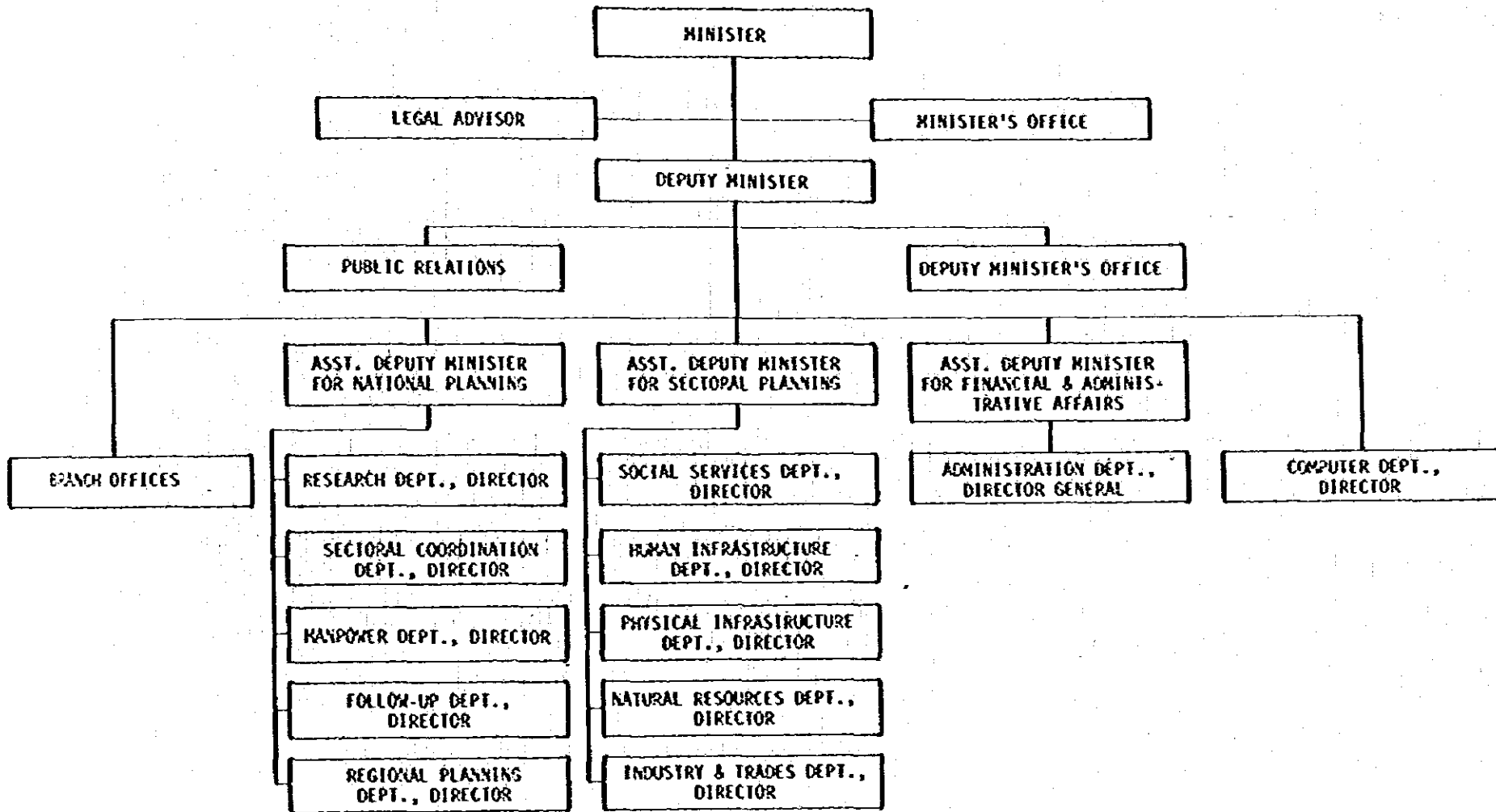

サウディ・アラビア

企 画 省

農業水資源省組織図

MINISTRY OF AGRICULTURE & WATER RESOURCES

サウディ・アラビア

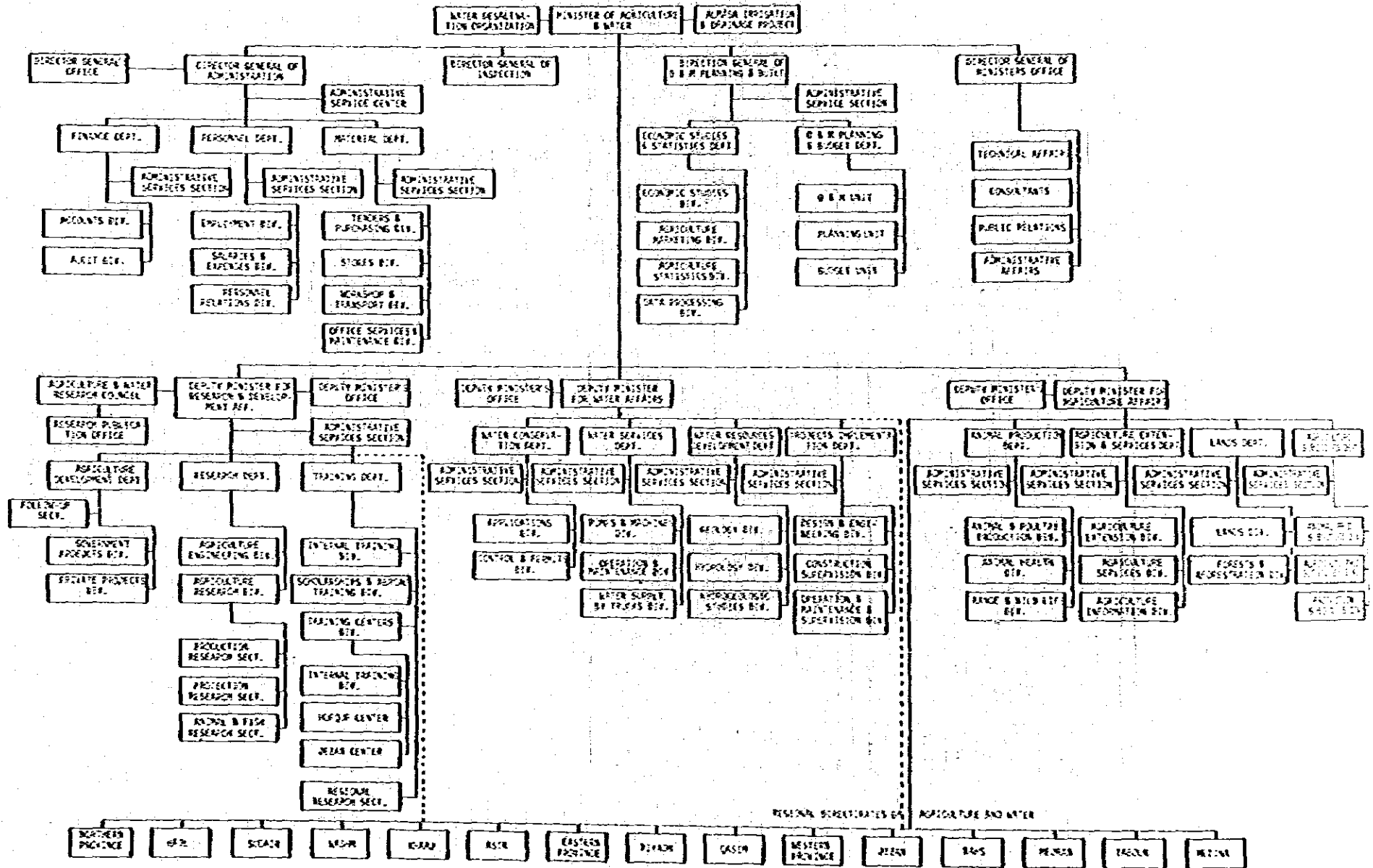

農業水資源省

MINISTRY OF HEALTH

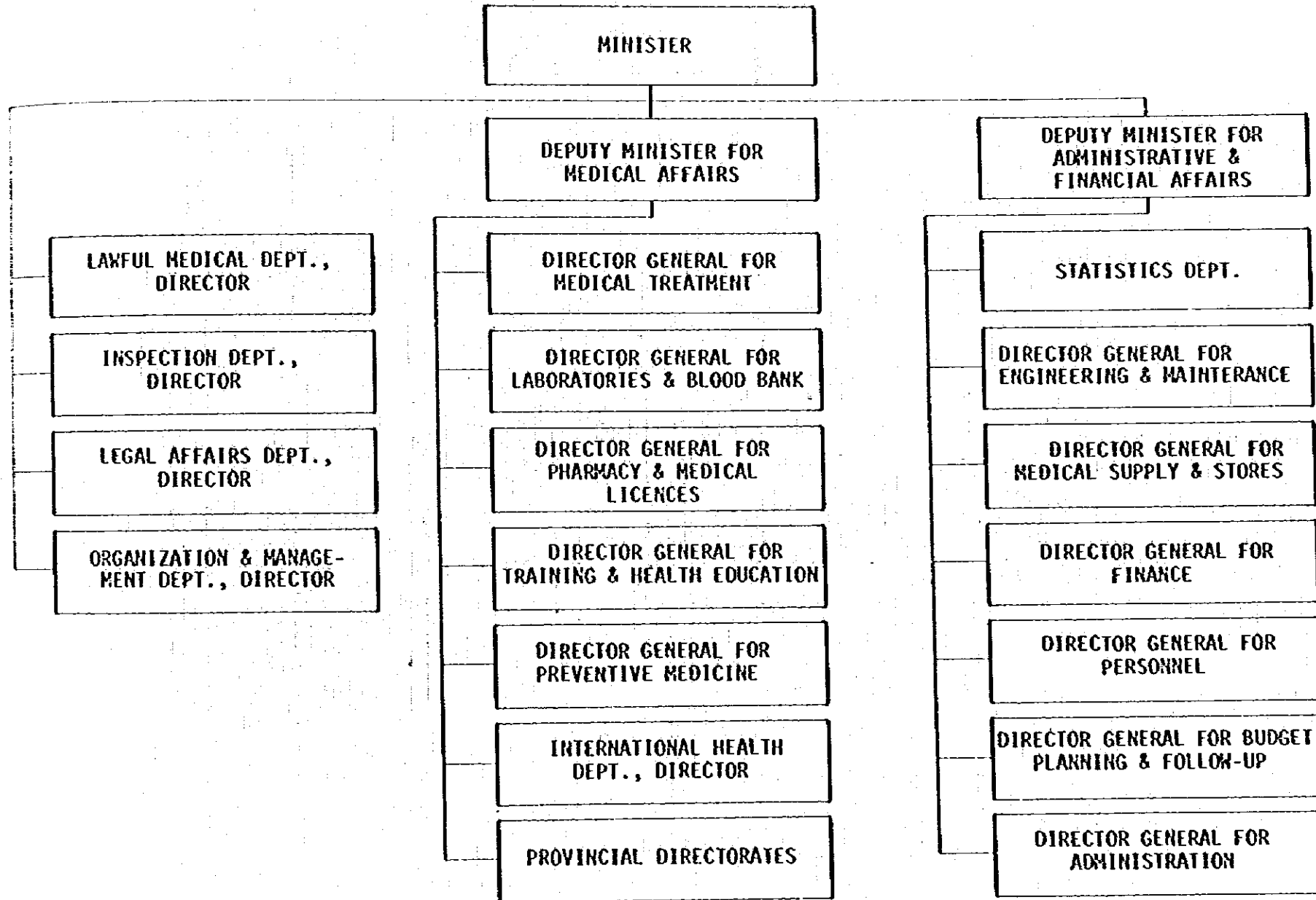

サウディ・アラビア

保 健 省

商 業 省 組 織 図

サウディ・アラビア

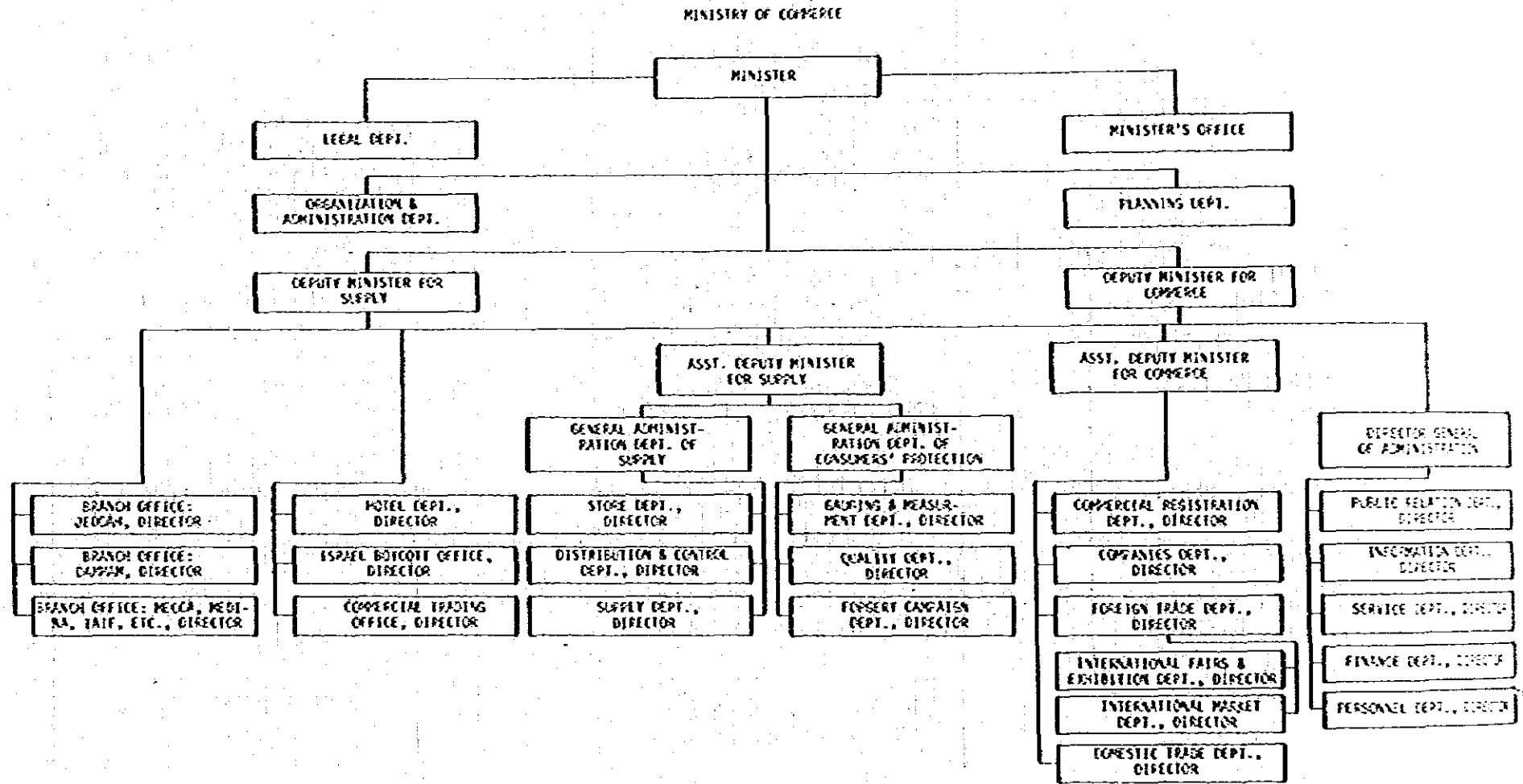

商 業 省

郵便電信電話省組織図

MINISTRY OF POST, TELEPHONE & TELEGRAPH

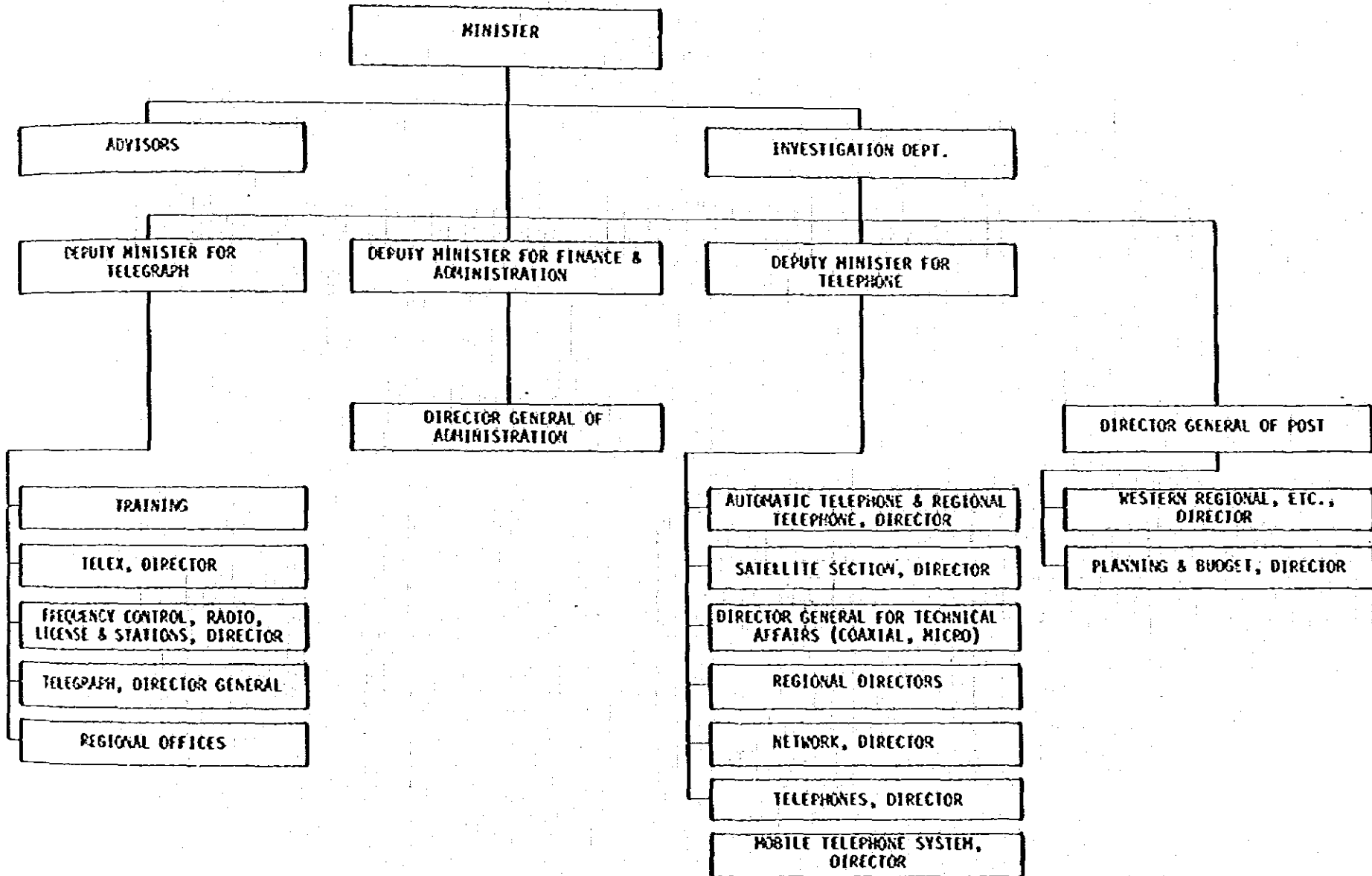

サウディアラビア

郵便電信電話省

石油鉱物資源省組織図

MINISTRY OF PETROLEUM & MINERAL RESOURCES

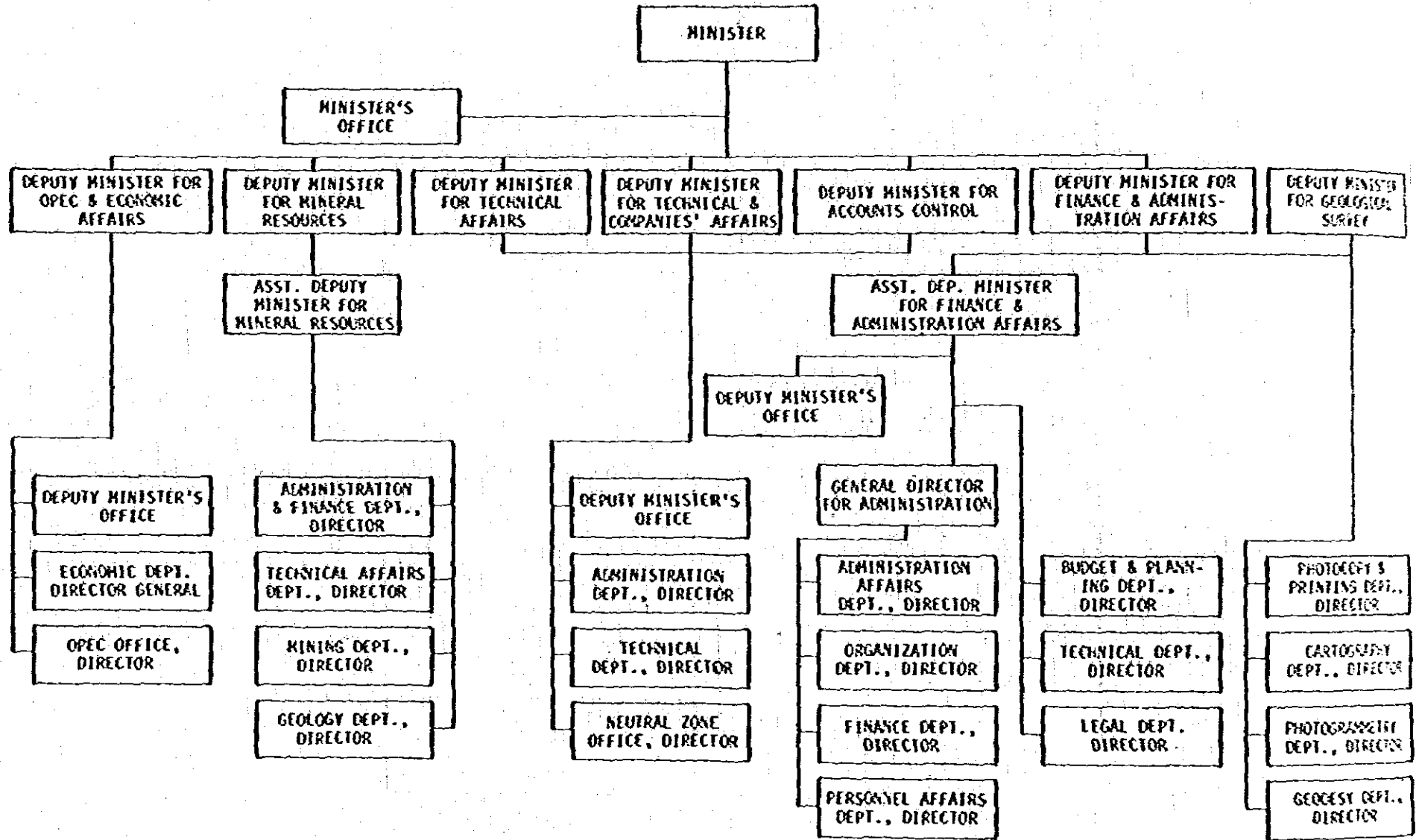

工業電力省組織図
 MINISTRY OF INDUSTRY & ELECTRICITY

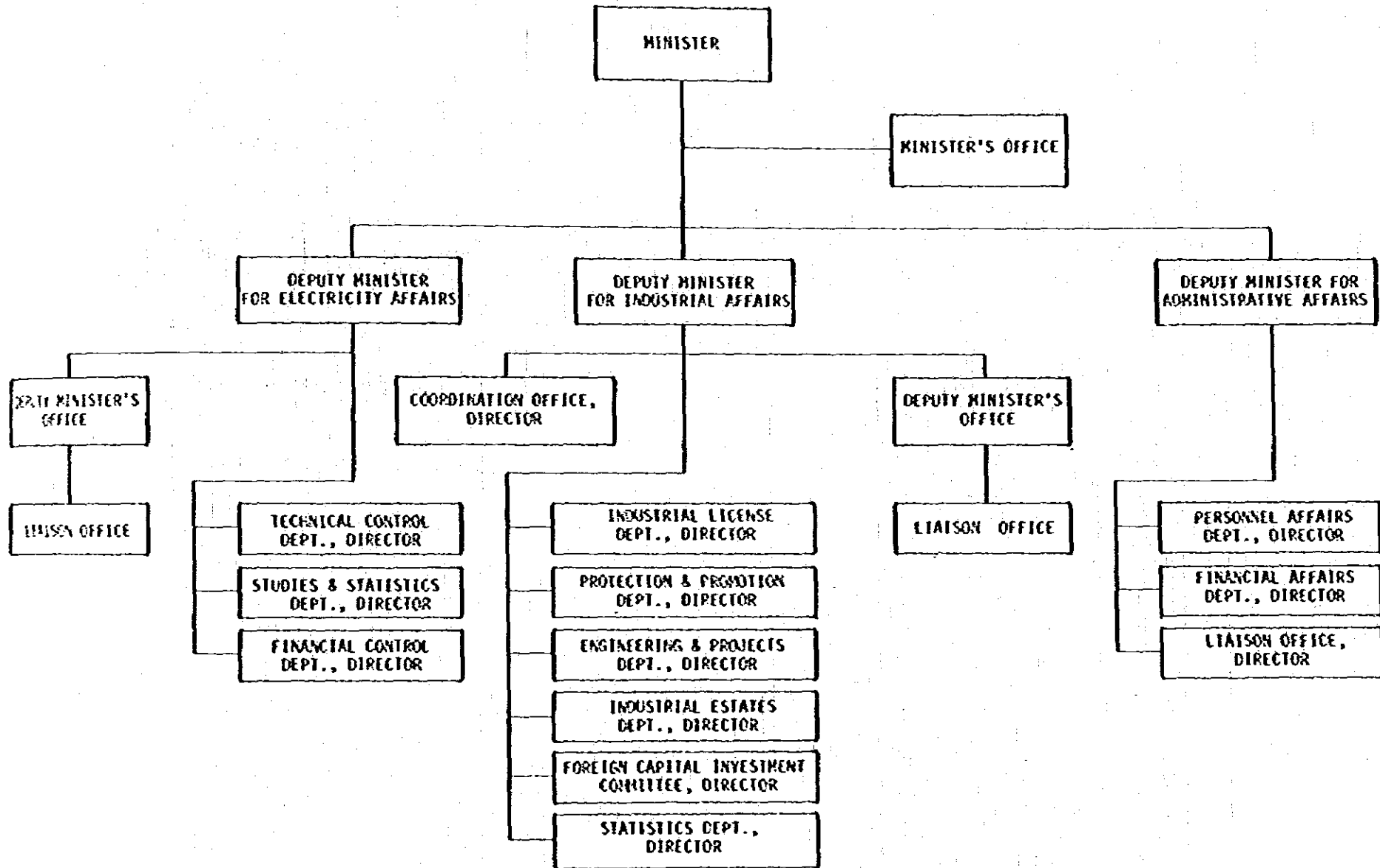

サウディ・アラビア

工業電力省

交通省組織図
MINISTRY OF COMMUNICATION

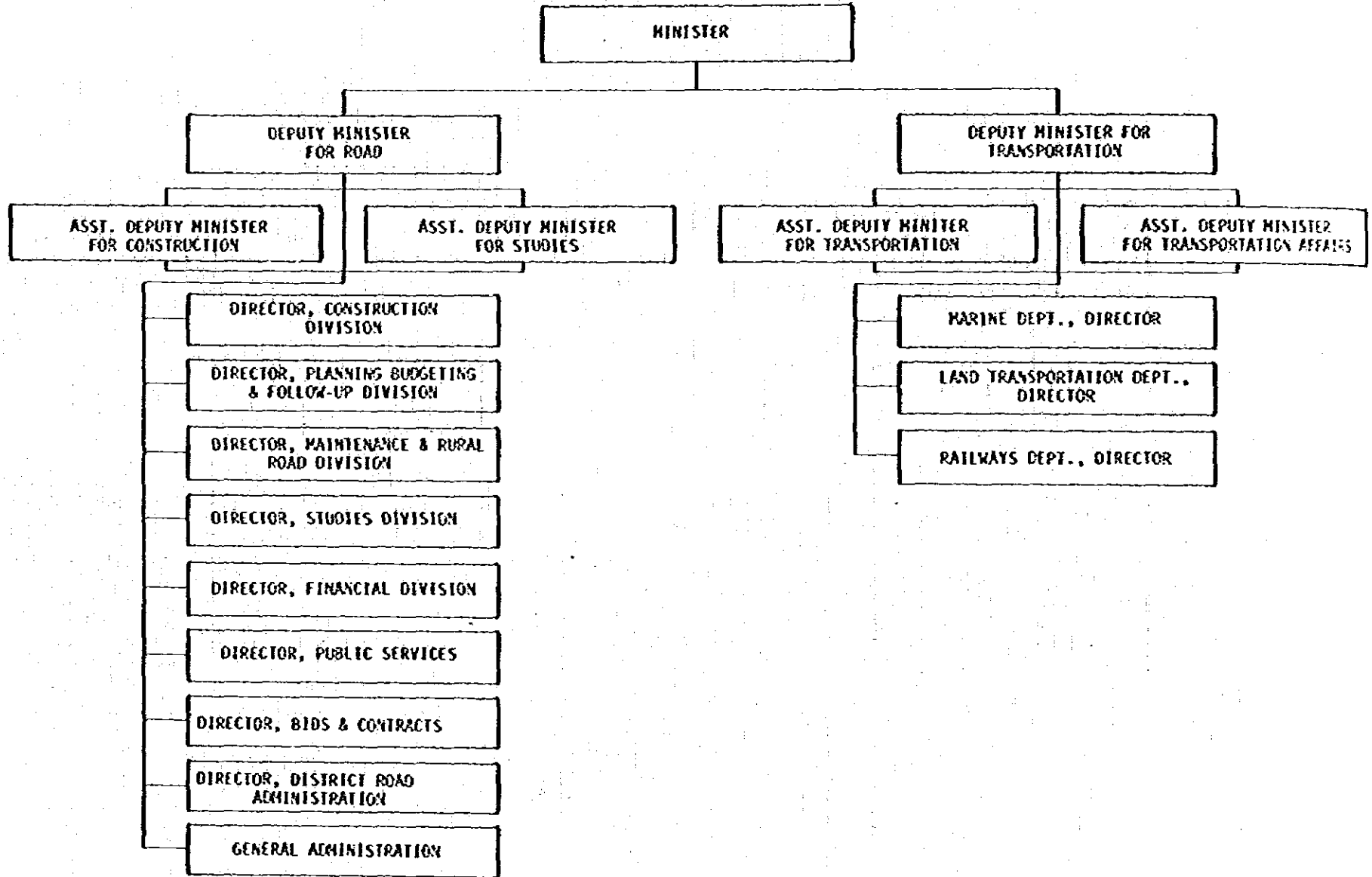

サウディ・アラビア

交
通
省

労働社会問題省組織図

MINISTRY OF LABOUR & SOCIAL AFFAIRS

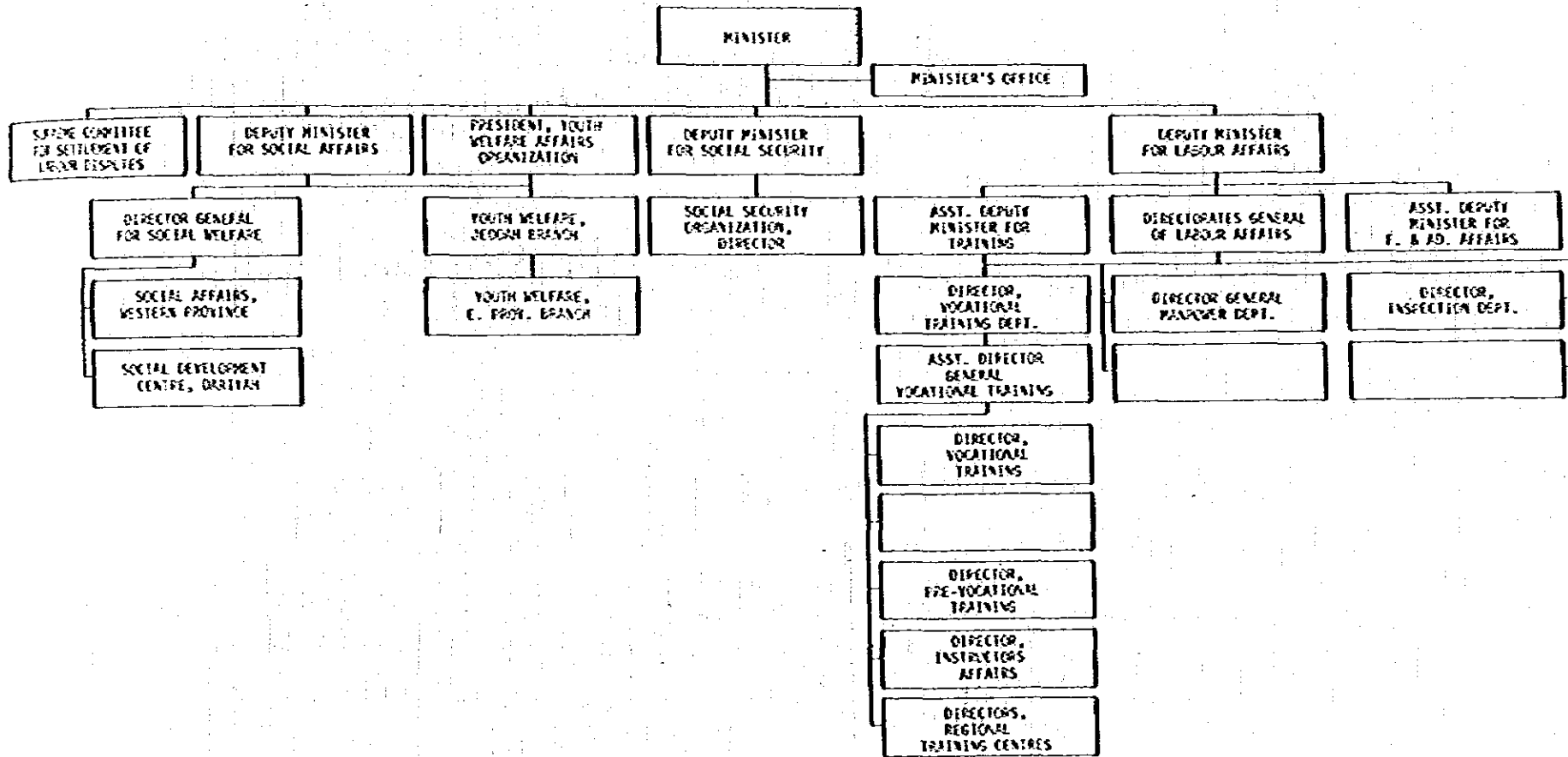

サウディ・アラビア

労働社会問題省

内務省組織図
MINISTRY OF INTERIOR

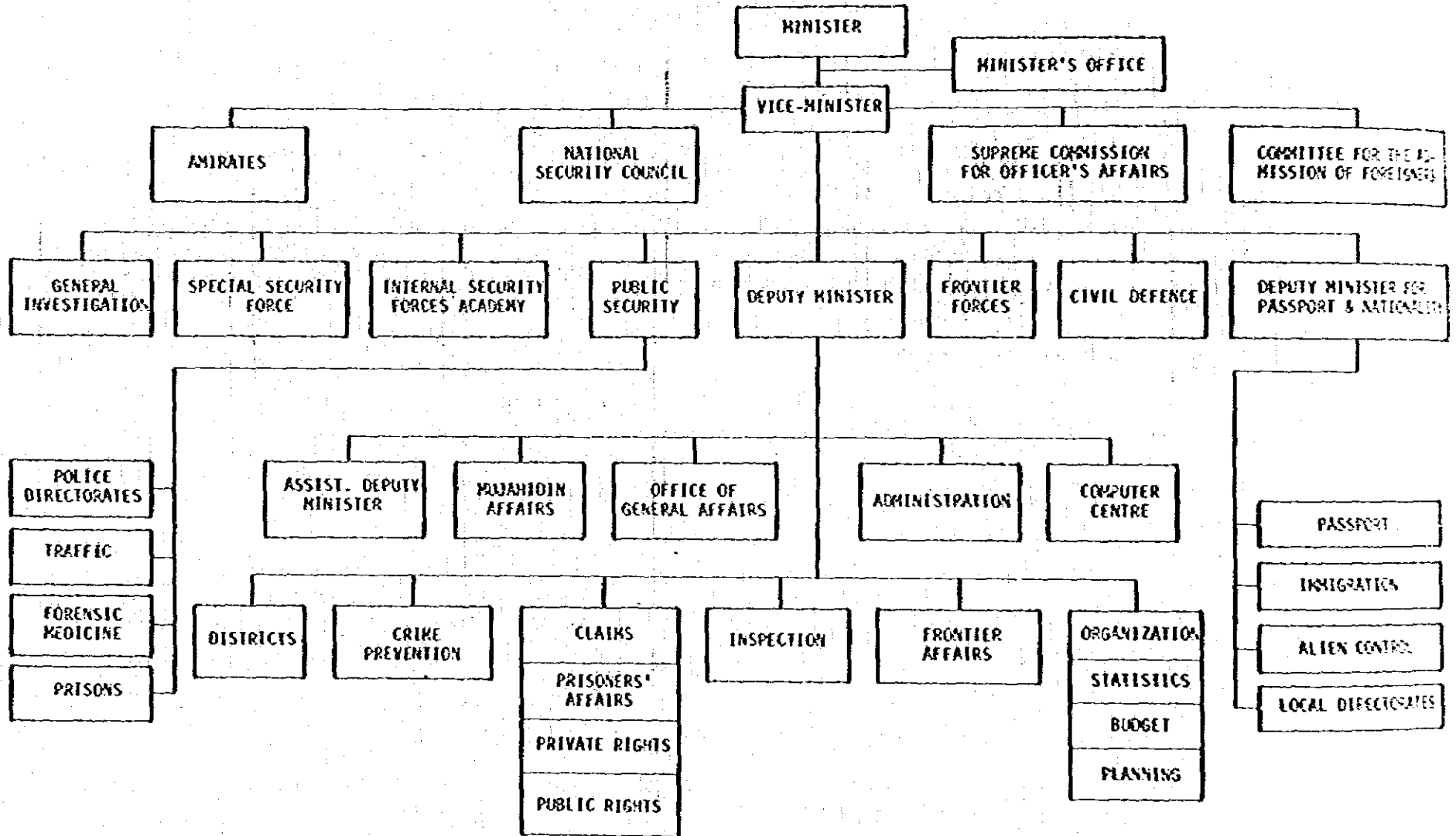

司 法 省 組 織 図

MINISTRY OF JUSTICE

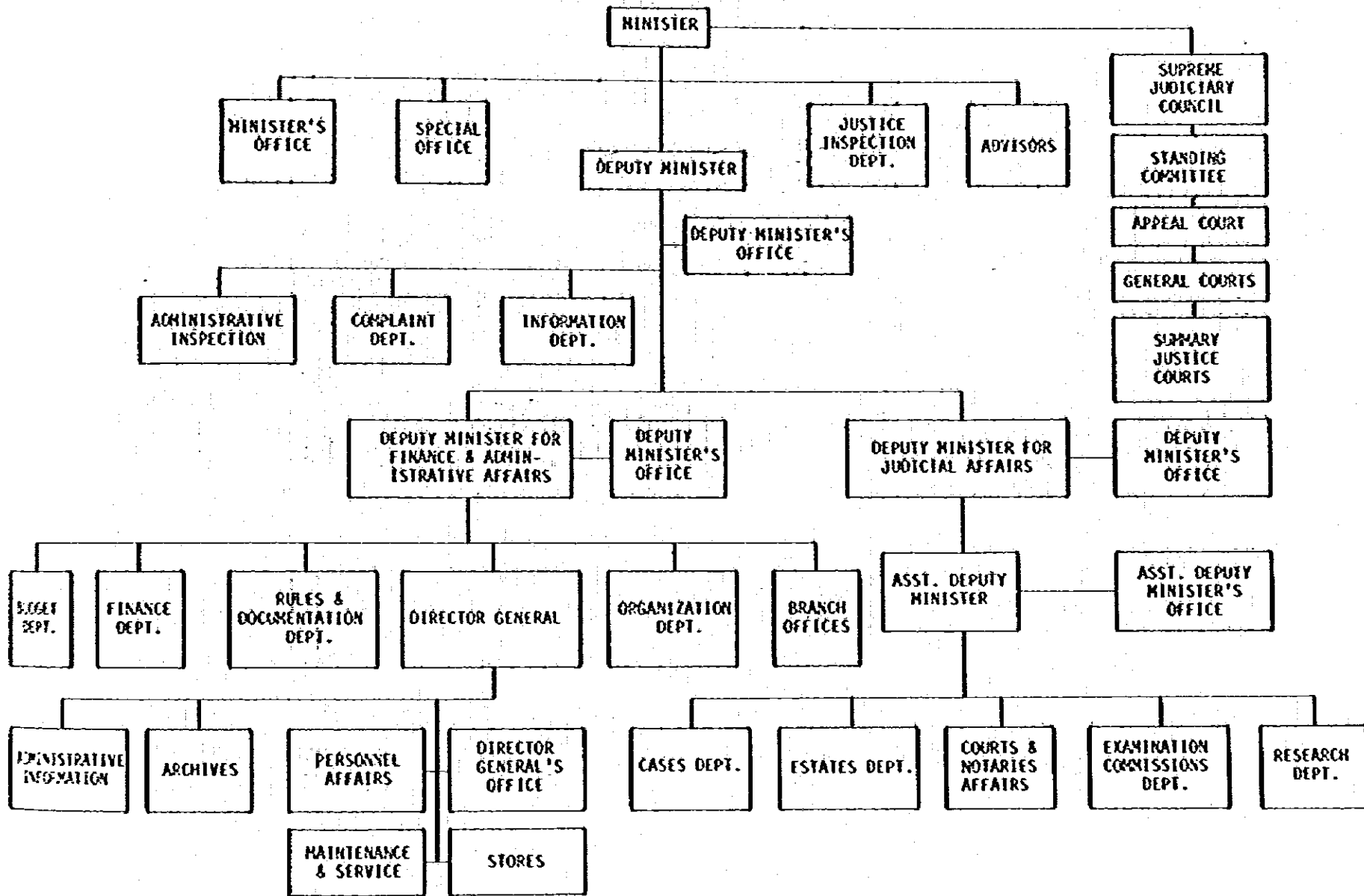

サウディ・アラビア

司
法
省

情報省組織図

MINISTRY OF INFORMATION

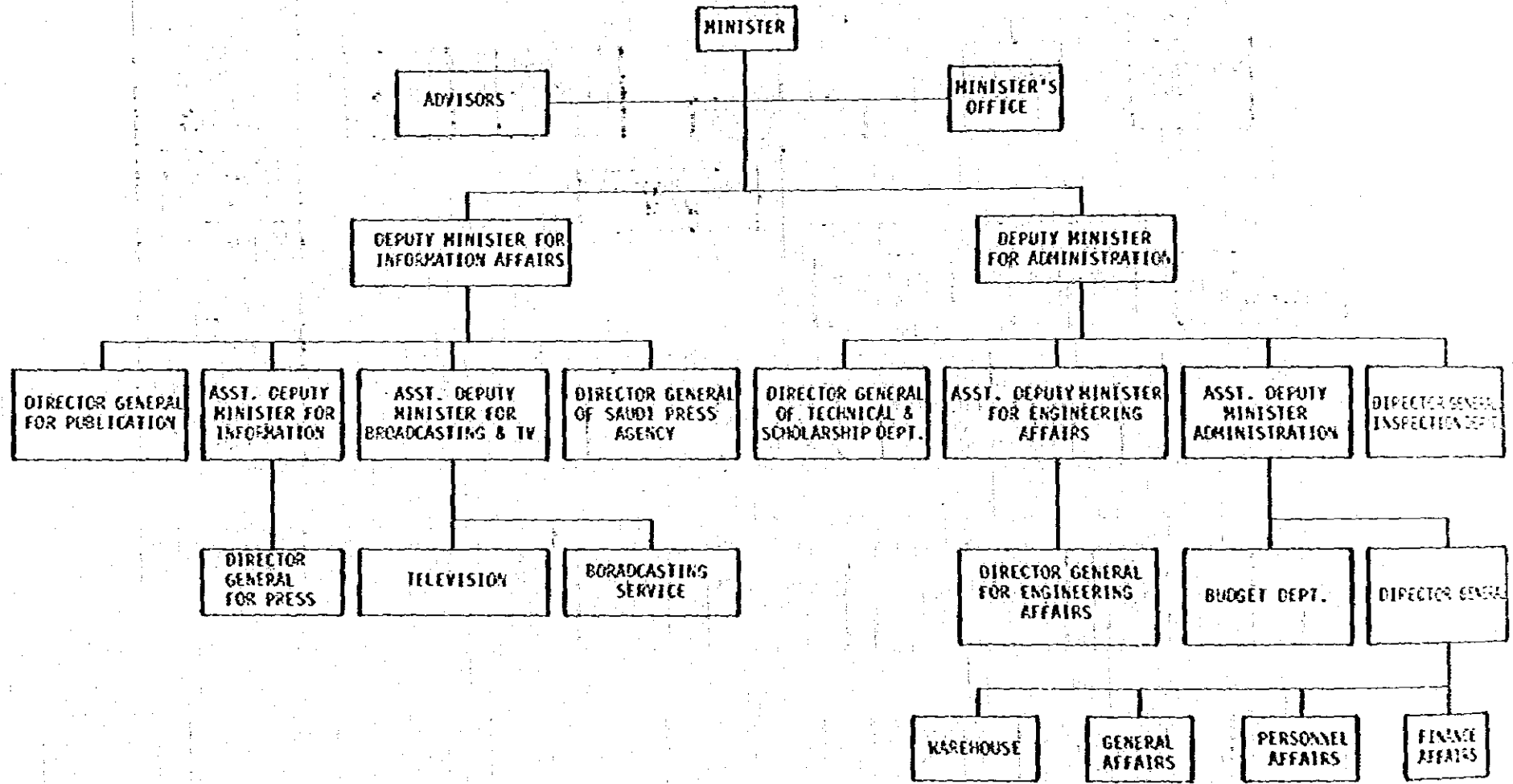

都市村落省組織図

サウディ・アラビア

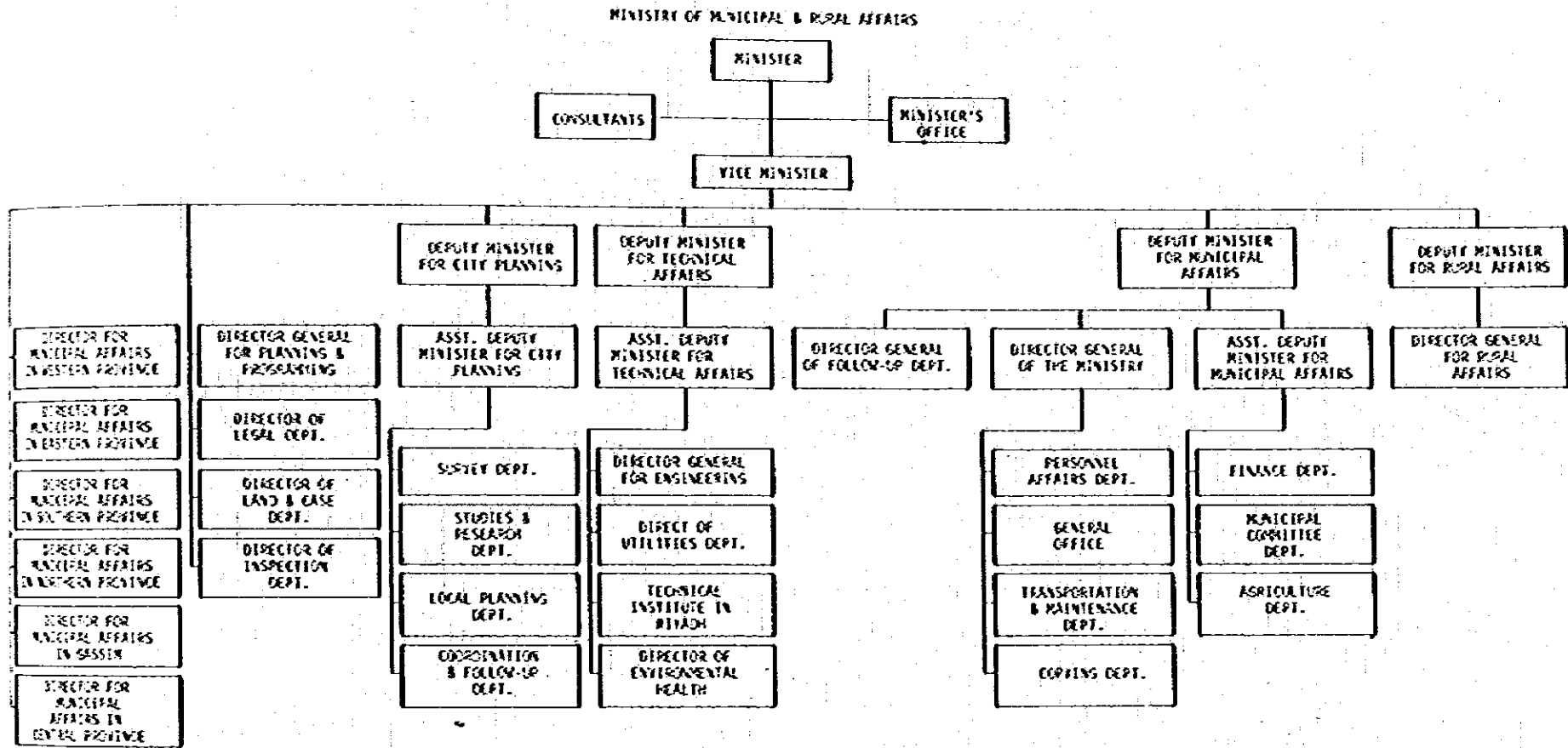

都市村落省

教育省組織図

MINISTRY OF EDUCATION

MINISTER

MINISTER'S OFFICE

ADVISORS

ADMINISTRATIVE INSPECTION UNIT

LEGAL AFFAIRS UNIT

DEPUTY MINISTER FOR TECHNICAL AFFAIRS

DEPUTY MINISTER FOR EDUCATIONAL & ADMINISTRATIVE AFFAIRS

DEPUTY MINISTER FOR CULTURAL AFFAIRS

DEPUTY MINISTER'S OFFICE

DEPUTY MINISTER'S OFFICE

ISLAMIC DEPT.

TECHNICAL SUPERVISION COMMITTEE

DIRECTOR GENERAL OF CURRICULUM RESEARCH & EDUCATIONAL MATERIAL OFFICE

SCHOOL HEALTH DEPT.

BUDGETING & PLANNING UNIT

UNESCO SECRETARIAT

ORGANIZATION & MANAGEMENT UNIT

RESEARCH STATISTICS & EDUCATIONAL DOCUMENT UNIT

EXAMINATION UNIT

DIRECTOR GENERAL OF YOUTH WELFARE

DIRECTOR GENERAL OF TECHNICAL EDUCATION

ASST. DEPUTY MINISTER FOR ADMINISTRATION AFFAIRS

ASST. DEPUTY MINISTER FOR GENERAL EDUCATION AFFAIRS

ASST. DEPUTY MINISTER FOR CULTURE AFFAIRS

RESEARCH & PROGRAM OFFICE

ADMINISTRATIVE OFFICE

INDUSTRIAL EDUCATION DEPT.

ASST. DEPUTY MINISTER'S OFFICE

PHYSICAL EDUCATION DEPT.

SOCIAL EDUCATION DEPT.

AGRICULTURAL EDUCATION DEPT.

DIRECTOR GENERAL FOR ADMINISTRATION

DIRECTOR GENERAL OF SPECIAL EDUCATION PROGRAM

ART EDUCATION DEPT.

SCOUT EDUCATION DEPT.

COMMERCIAL EDUCATION DEPT.

WAREHOUSES DEPT.

PERSONNEL DEPT.

DIRECTOR GENERAL OF TEACHER TRAINING PROGRAM

ENGINEERING & MAINTENANCE DEPT.

COMMUNICATION & SERVICES DEPT.

FINANCE DEPT.

ISLAMIC EDUCATION DEPT.

PURCHASE DEPT.

ADMINISTRATIVE OFFICE

サウディアラビア

教育省

高等教育省組織図

MINISTRY OF HIGHER EDUCATION

サウディ・アラビア

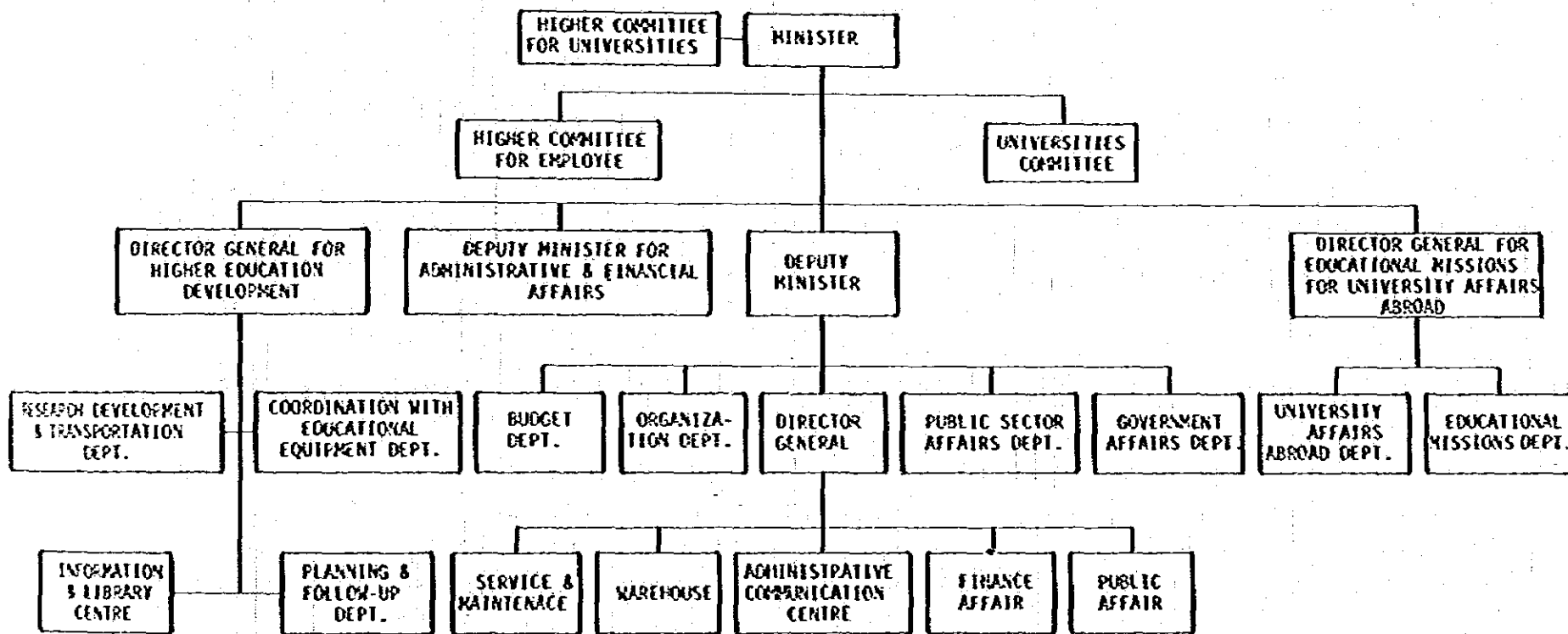

高等教育省

国防航空省組織図
MINISTRY OF DEFENCE & AIRWAYS

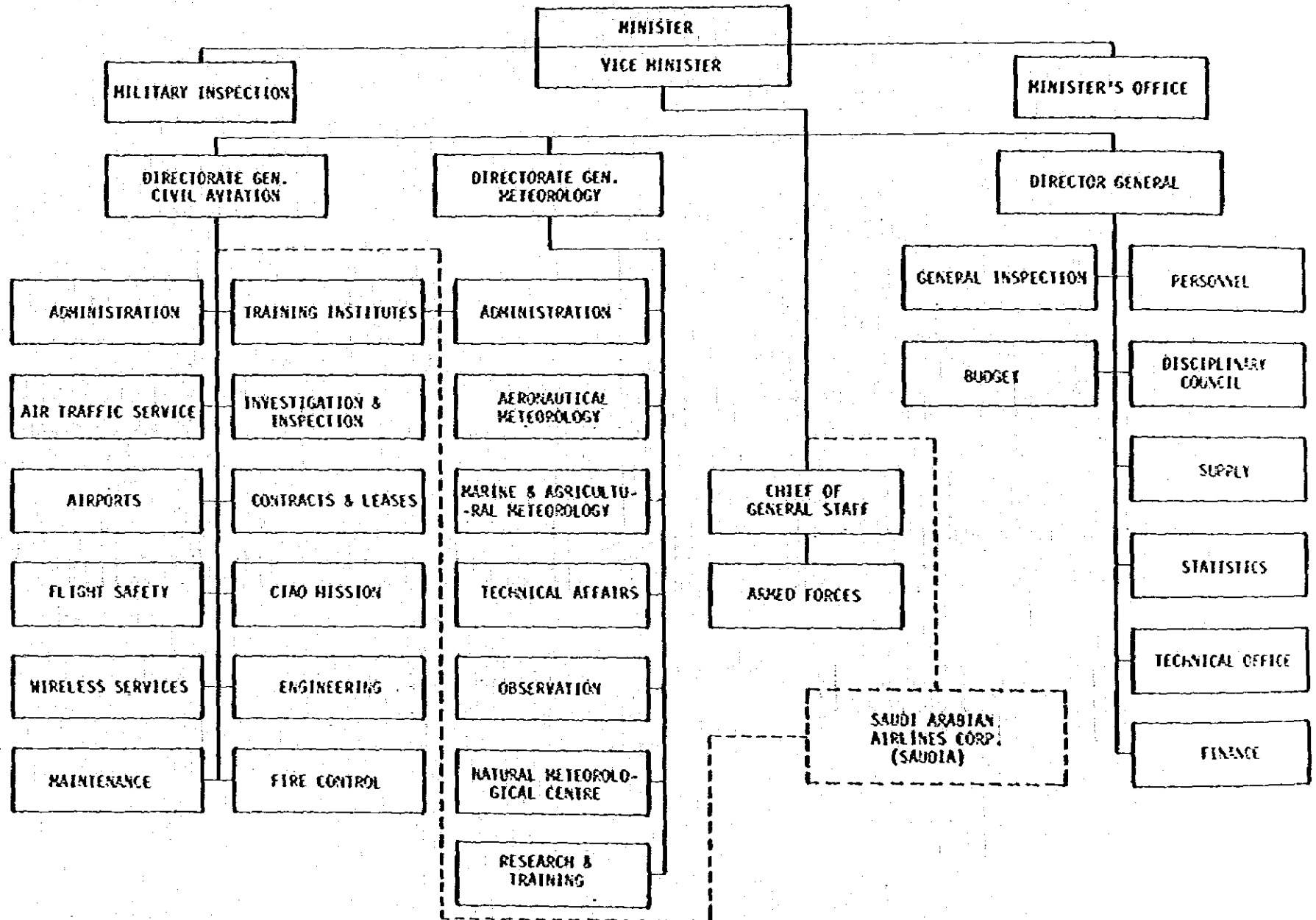

SAUDI GOVERNMENT RAILROAD ORGANIZATION (SGRRO)

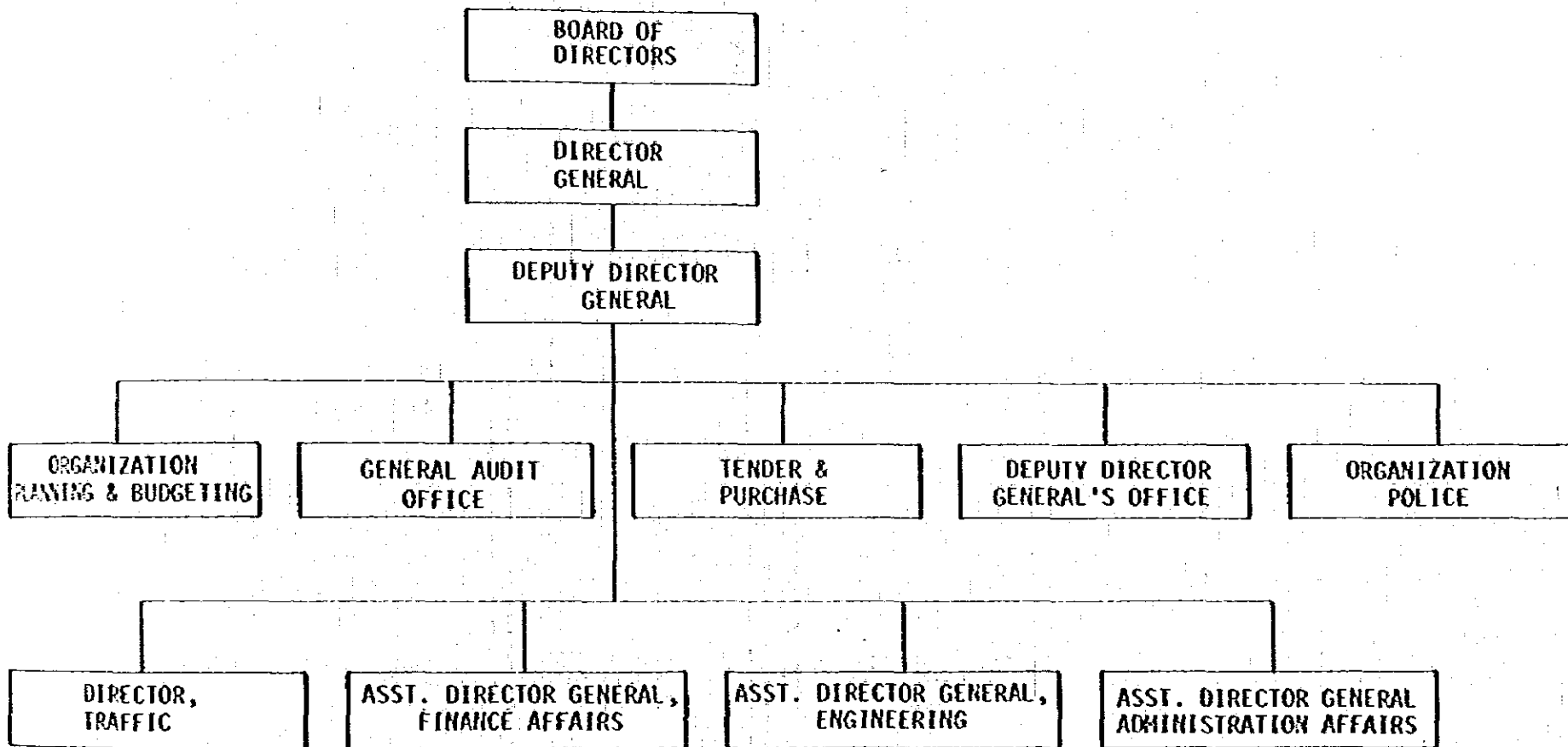

石油鉱物資源公団組織図

GENERAL PETROLEUM AND MINERALS ORGANIZATION (PETROMIN)

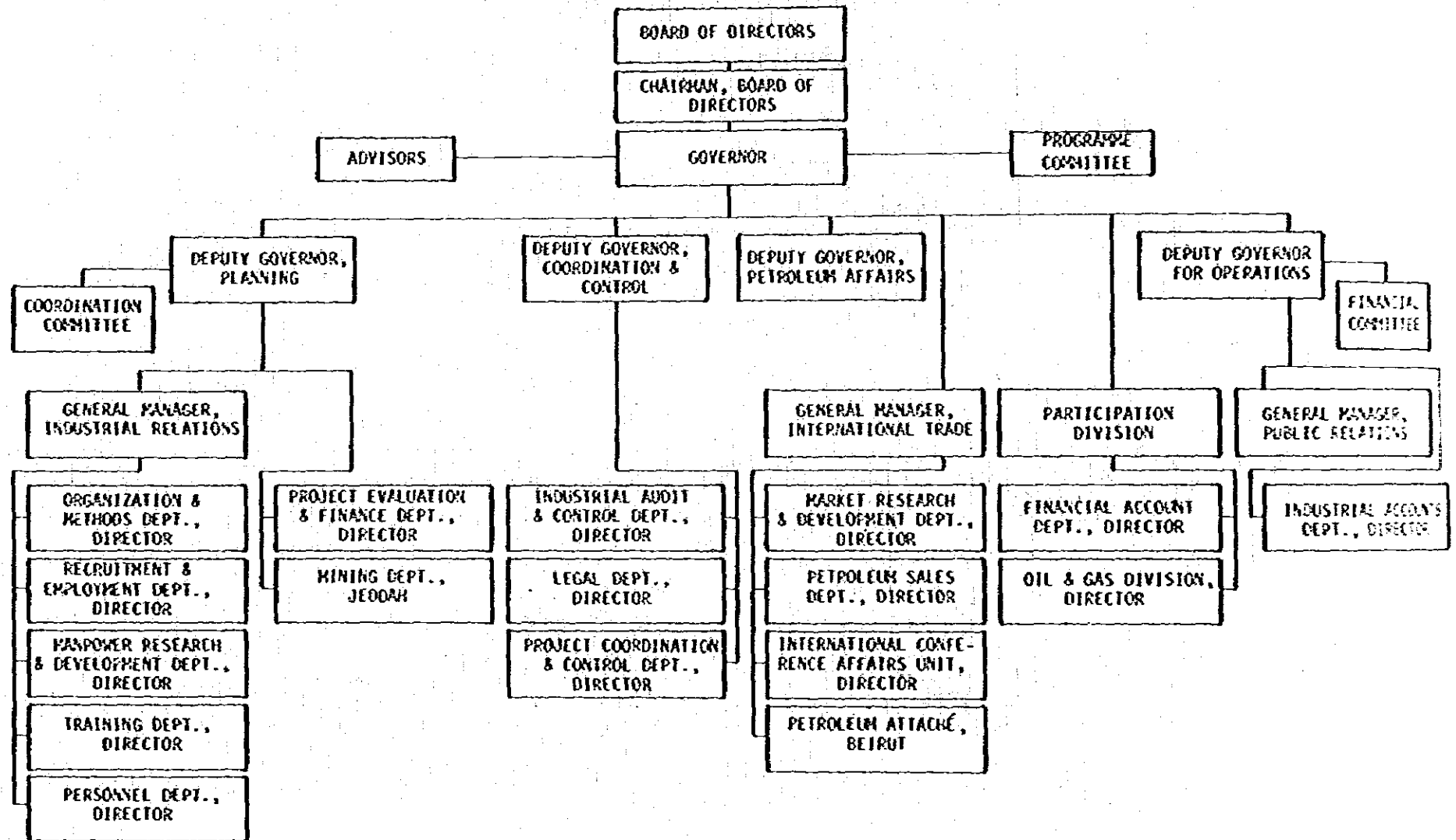

サウディ・アラビア

石油鉱物資源公団

THE SAUDI CONSULTING HOUSE

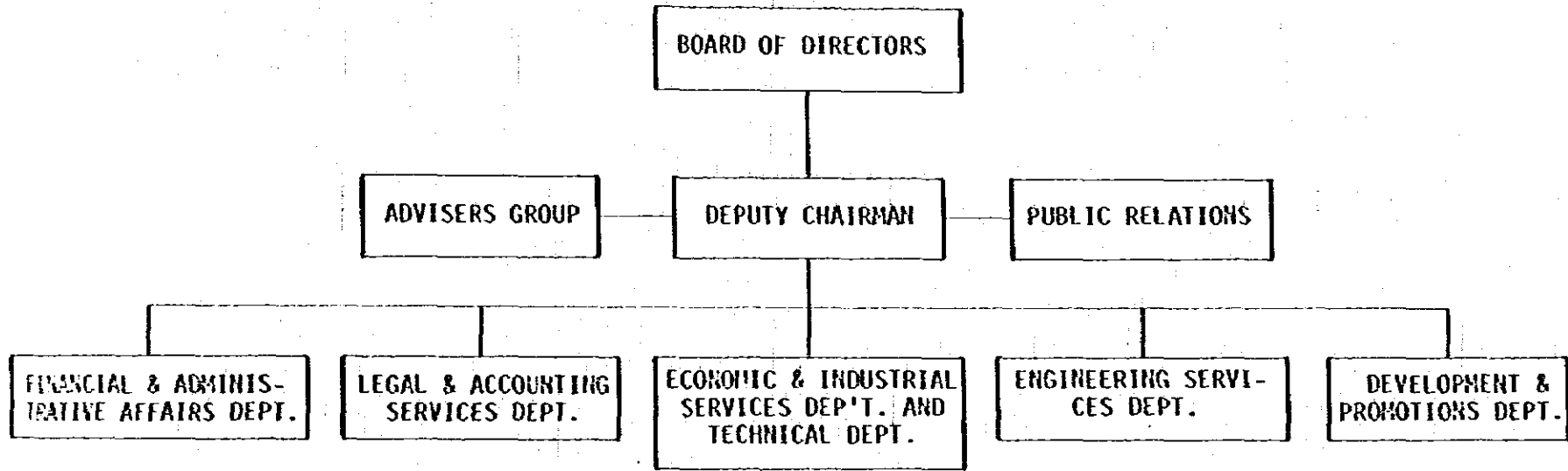

社会保険事業団組織図
GENERAL SOCIAL INSURANCE ORGANIZATION

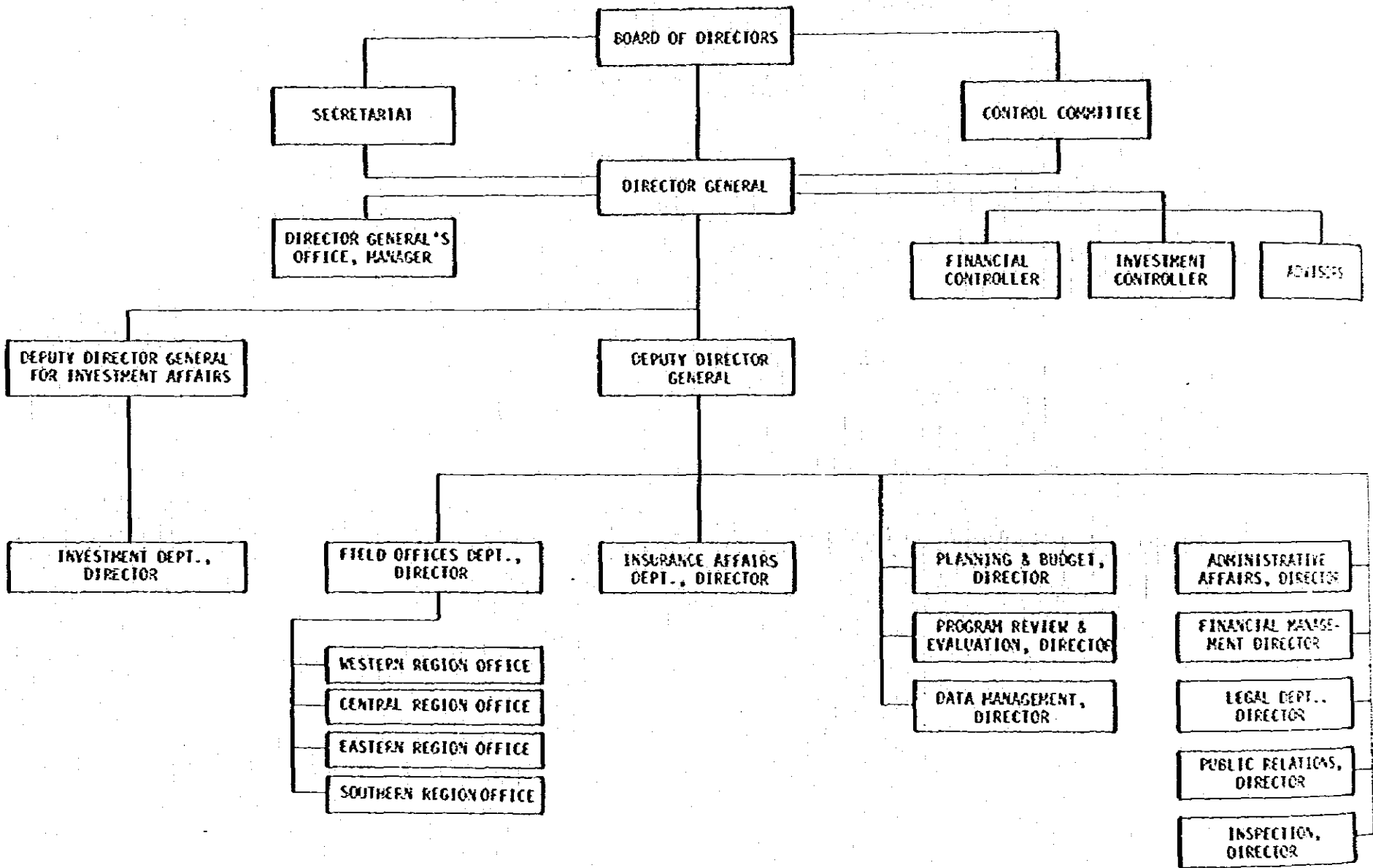

SAUDI ARABIAN STANDARDS ORGANIZATION (SASO)

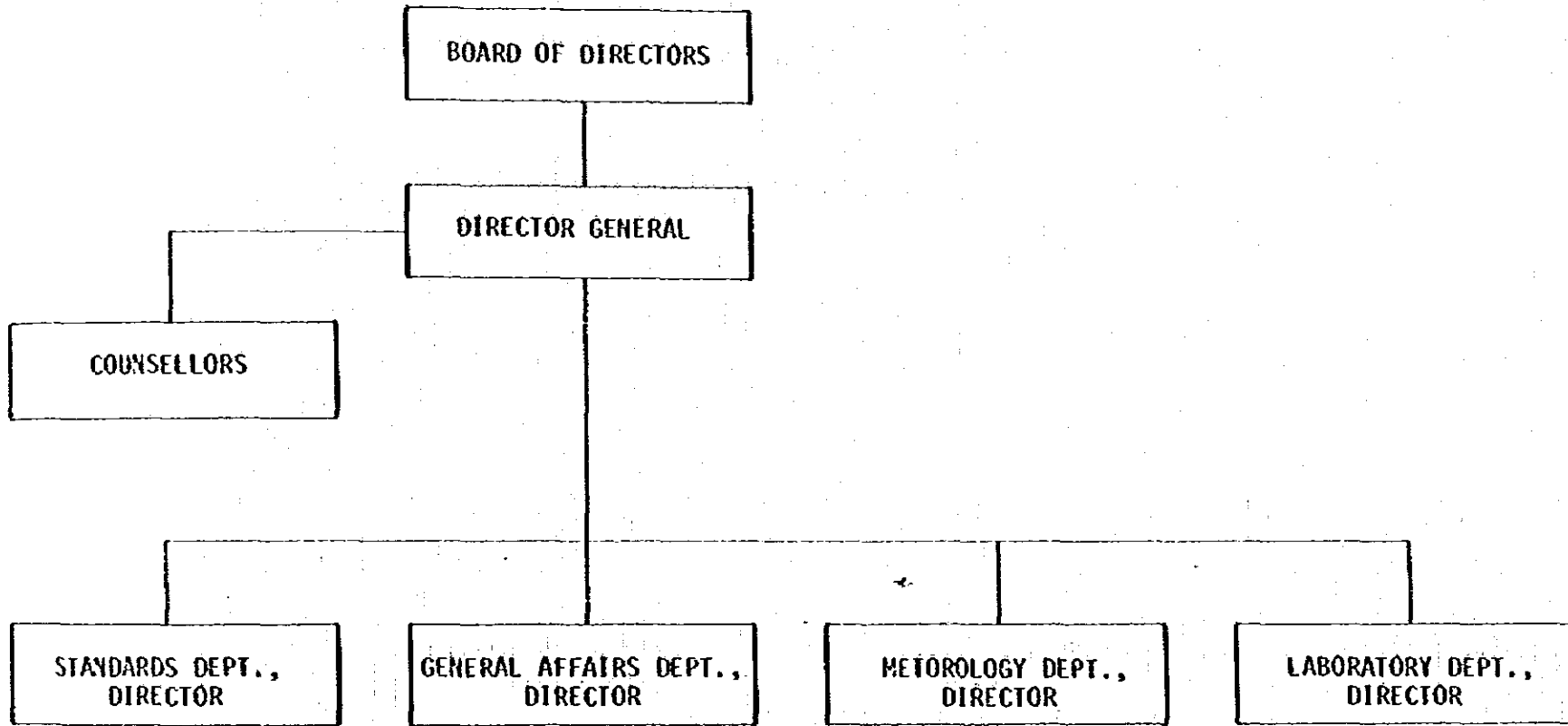

工業開発基金組織図
SAUDI INDUSTRIAL DEVELOPMENT FUND (SIDF)

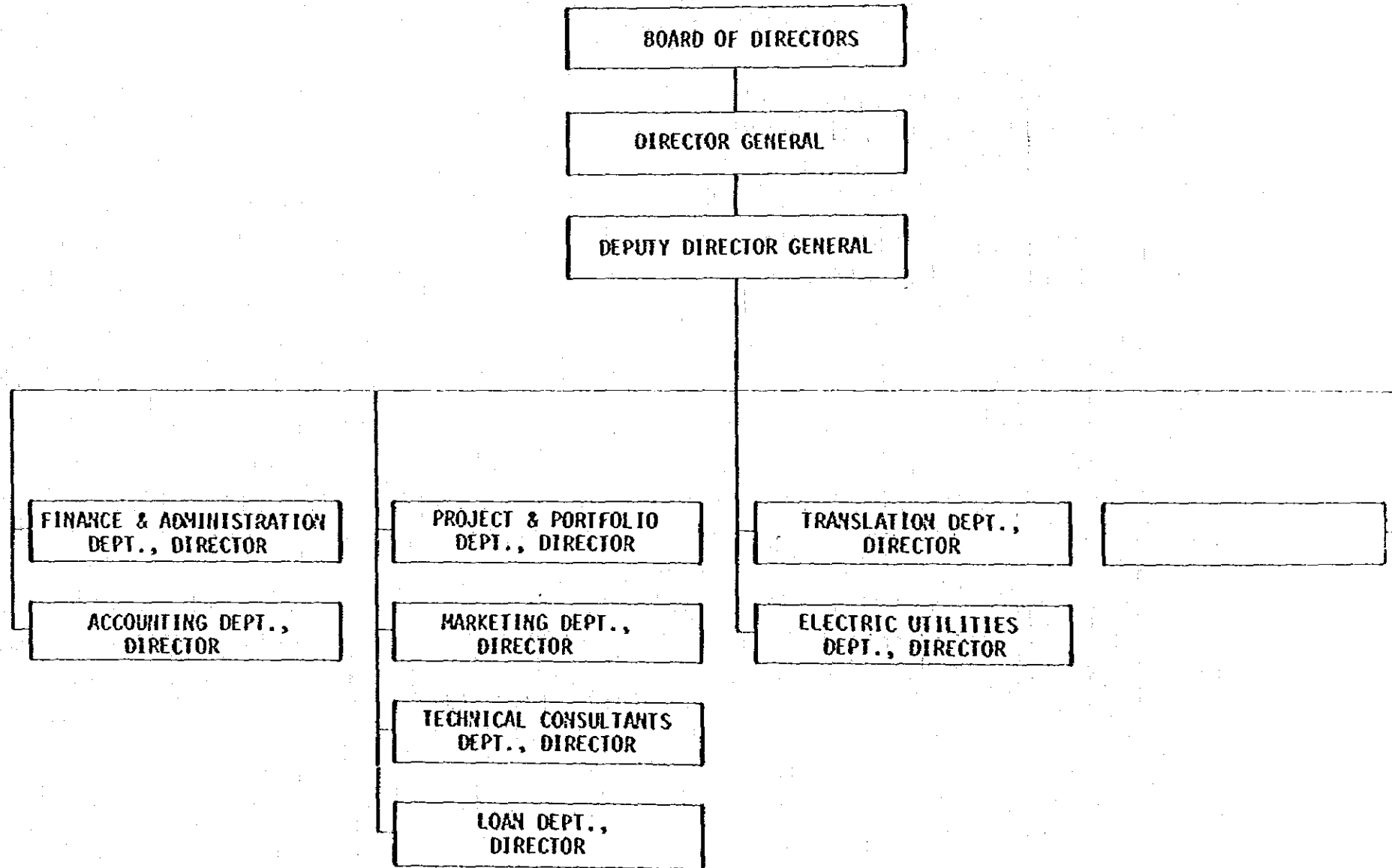

SAUDI FUND FOR DEVELOPMENT (SDF)

サウディ・アラビア

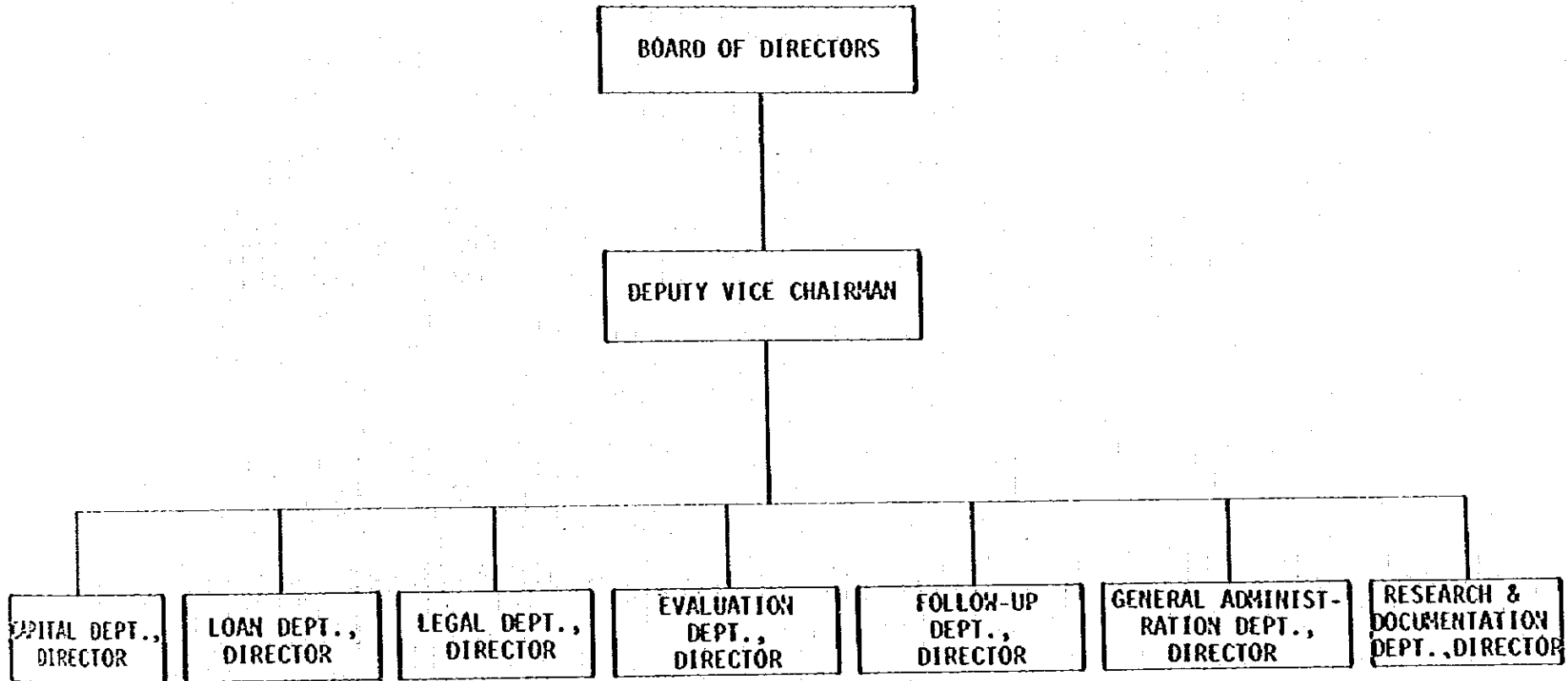

サウディ開発基金

電力公団組織図
ELECTRICITY CORPORATION

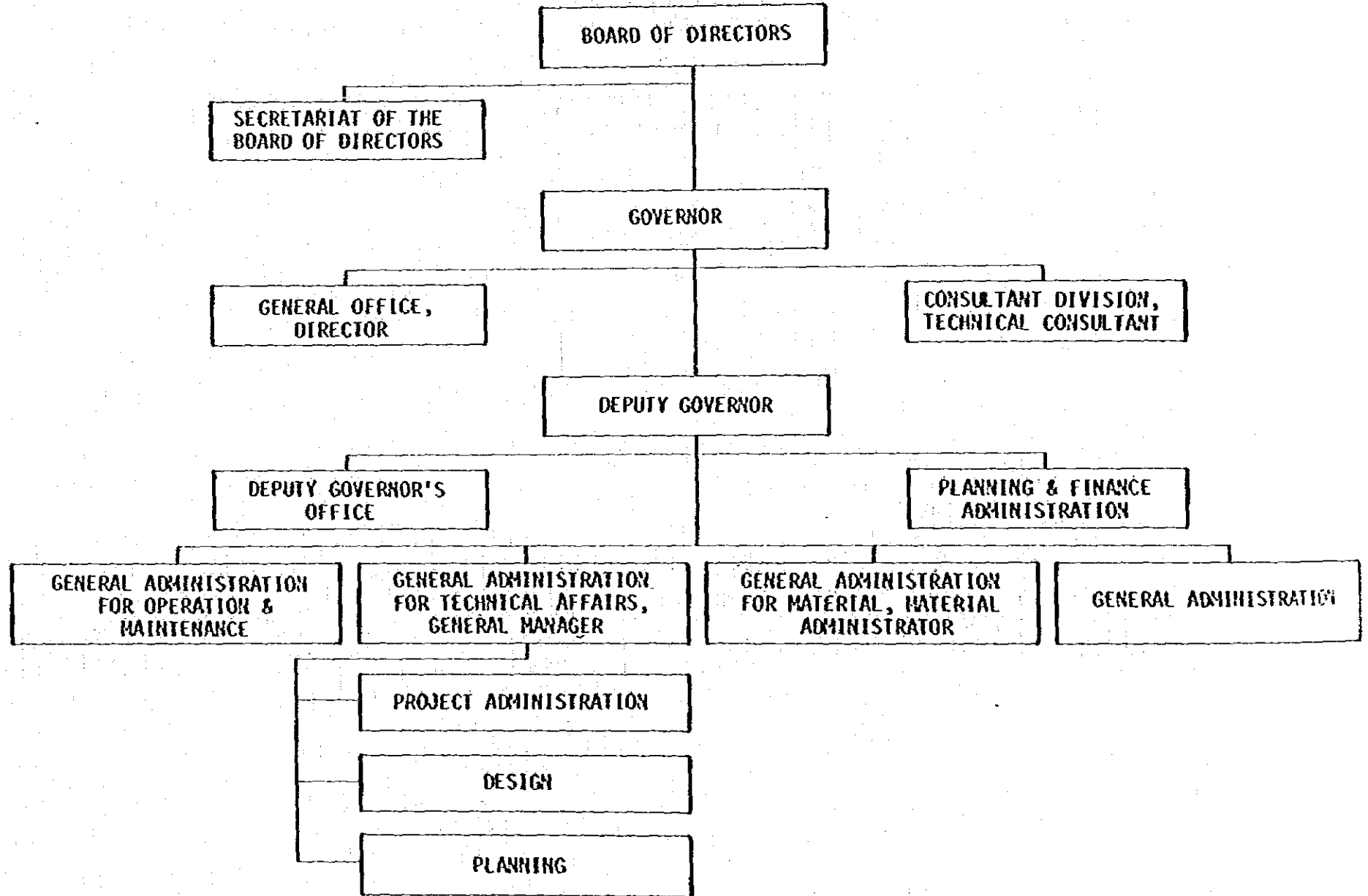

サウディ・アラビア通貨機関組織図
 SAUDI ARABIAN MONETARY AGENCY (SAMA)

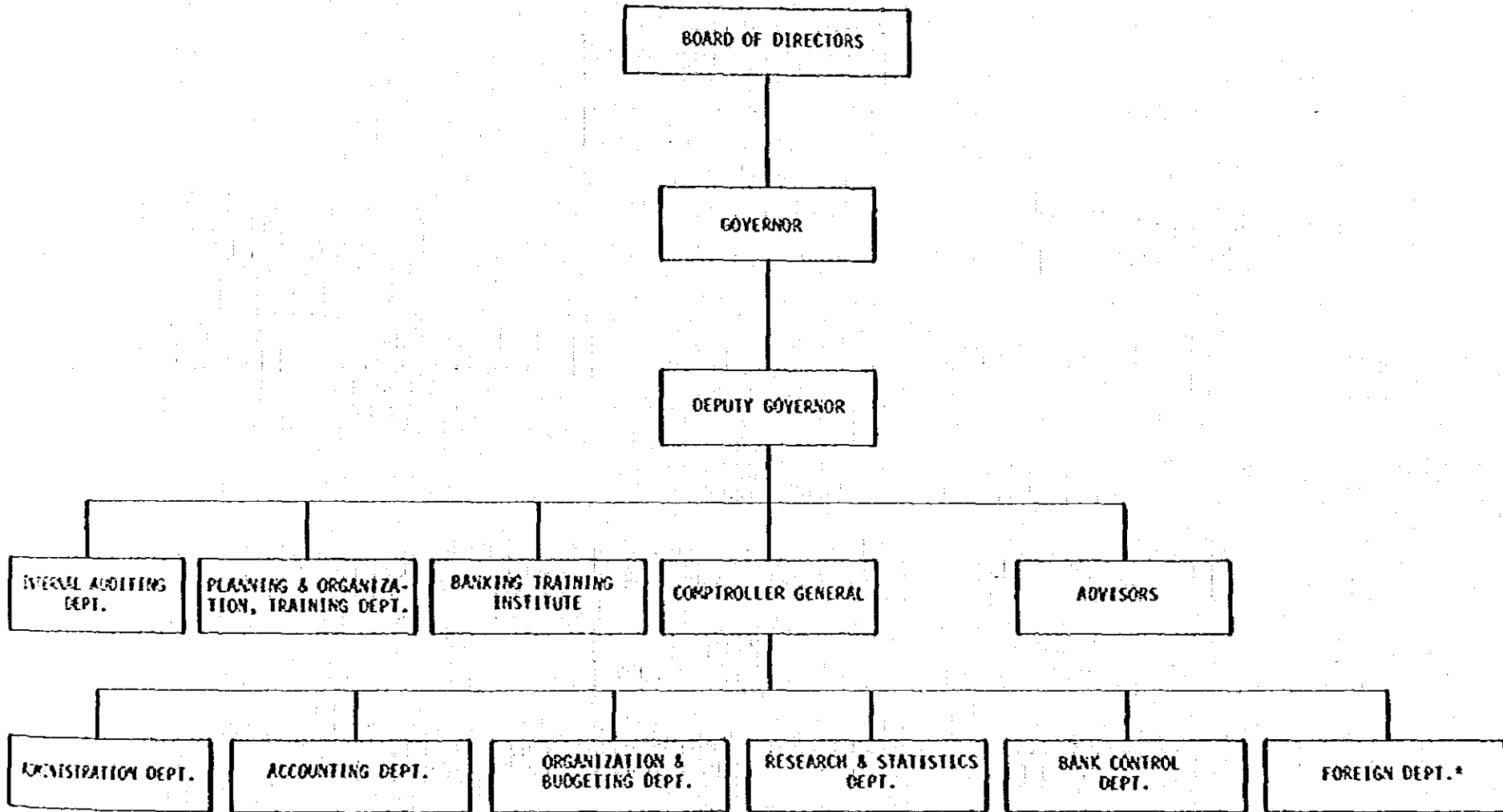

* Including INVESTMENT DEPT. and FOREIGN EXCHANGE DEPT.

SAUDI ARABIAN NATIONAL CENTRE FOR SCIENCE & TECHNOLOGY
(PROPOSED ORGANIZATION CHART)

サウディ・アラビア

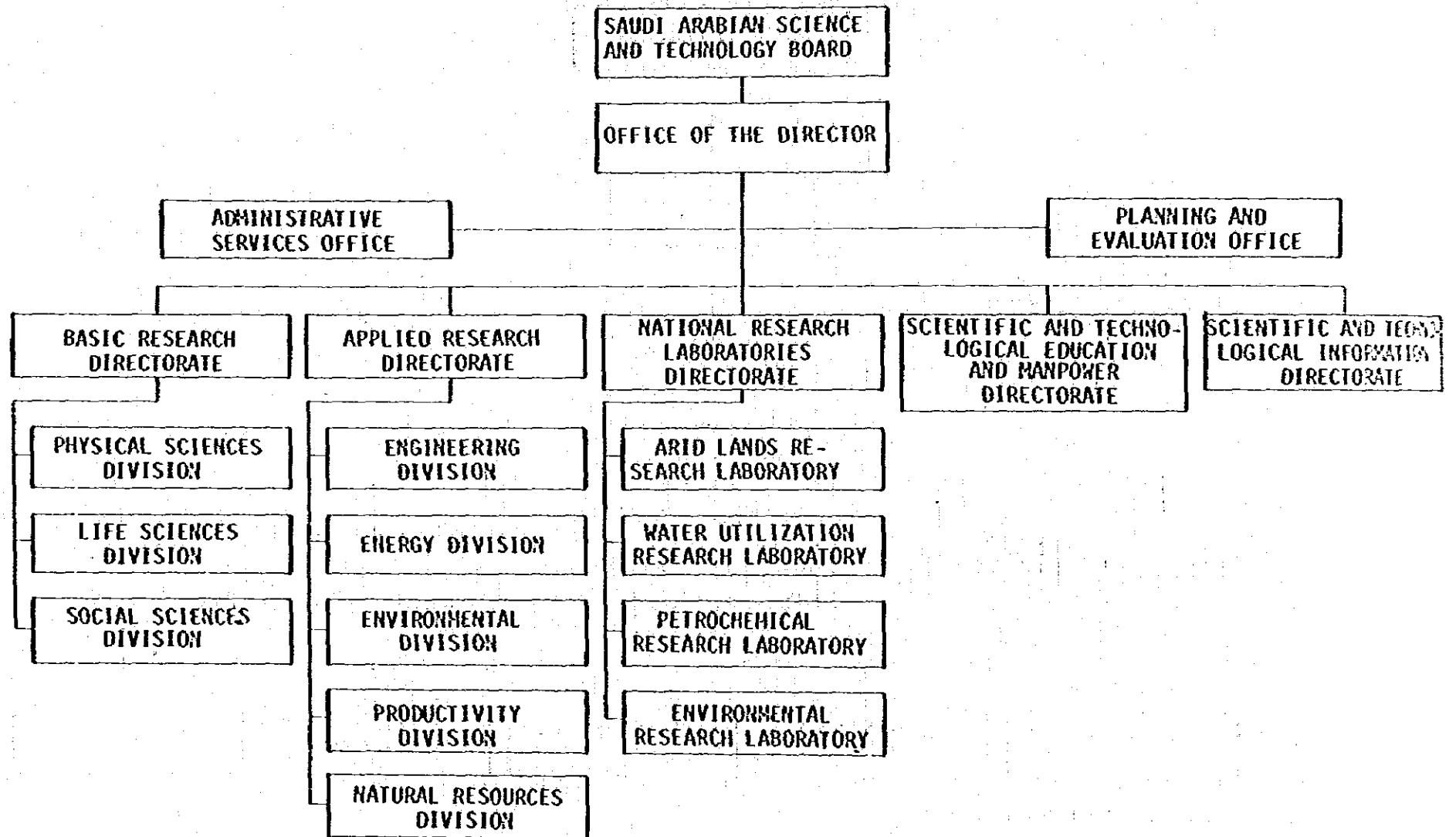

サウディ・アラビア科学技術センター

SALINE WATER CONVERSION CORPORATION (SWCC)

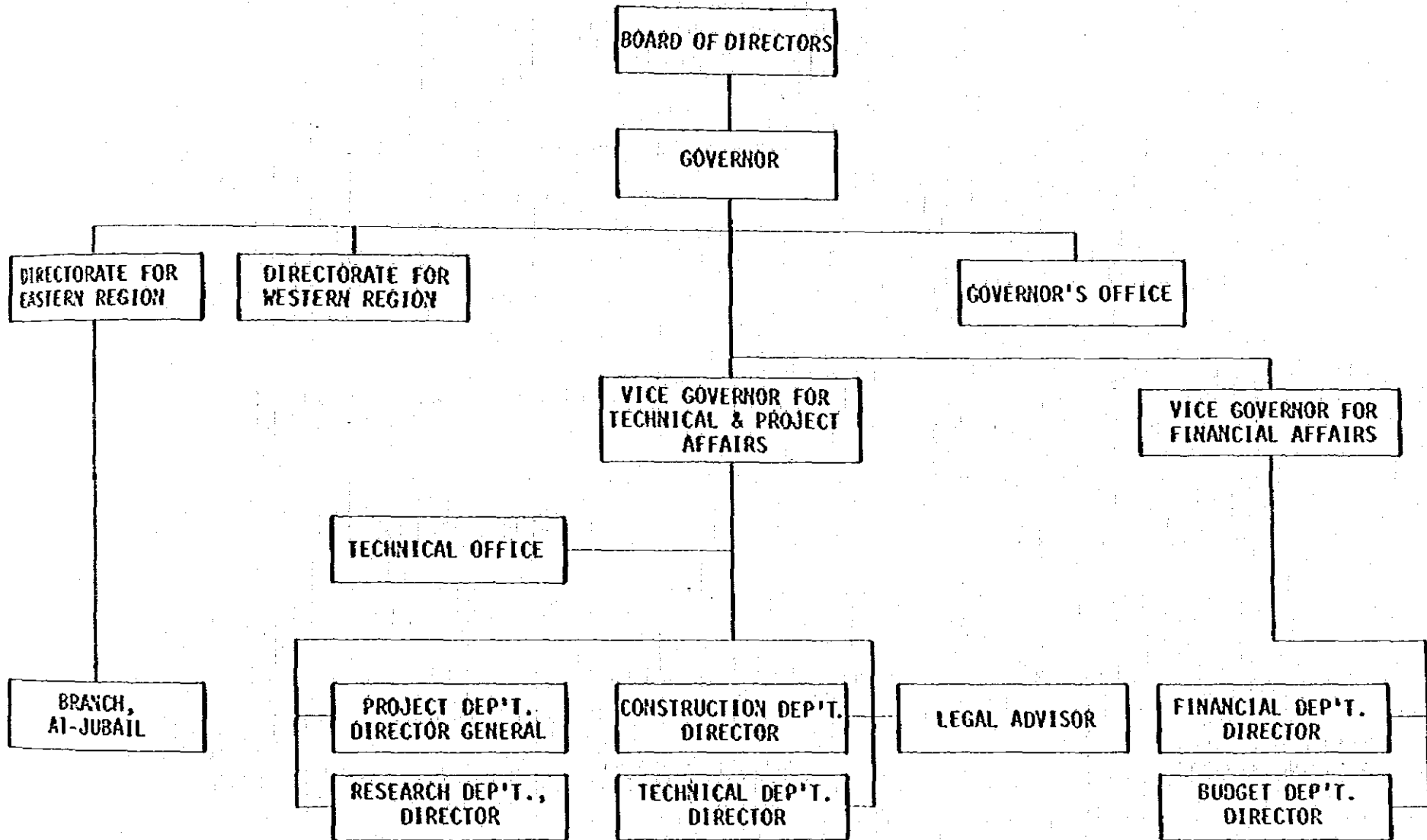

サウディ・アラビア 基幹産業 公団 組織図
SAUDI ARABIA BASIC INDUSTRIES CORPORATION (SABIC)

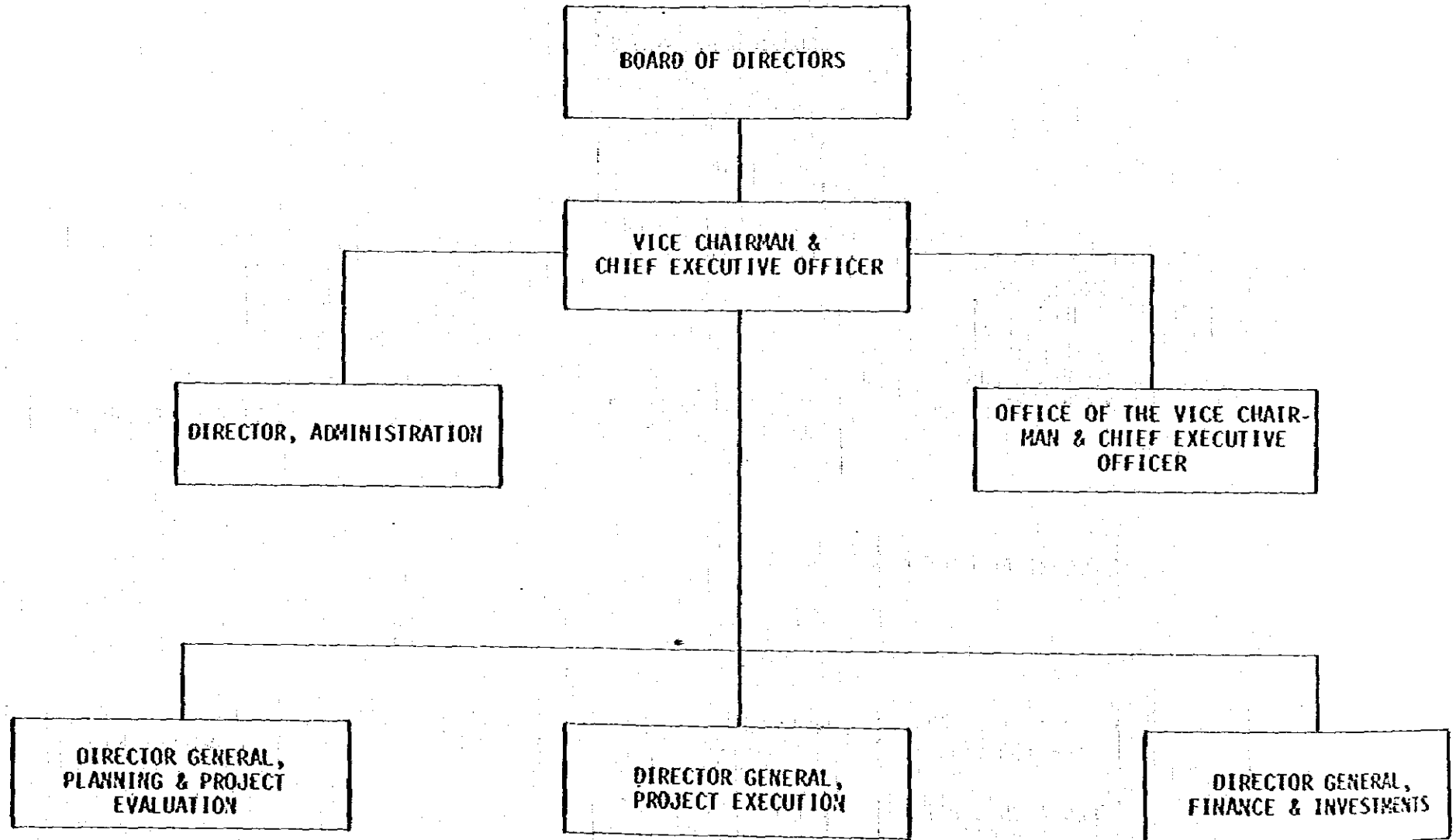

スーダン国政府行政組織図

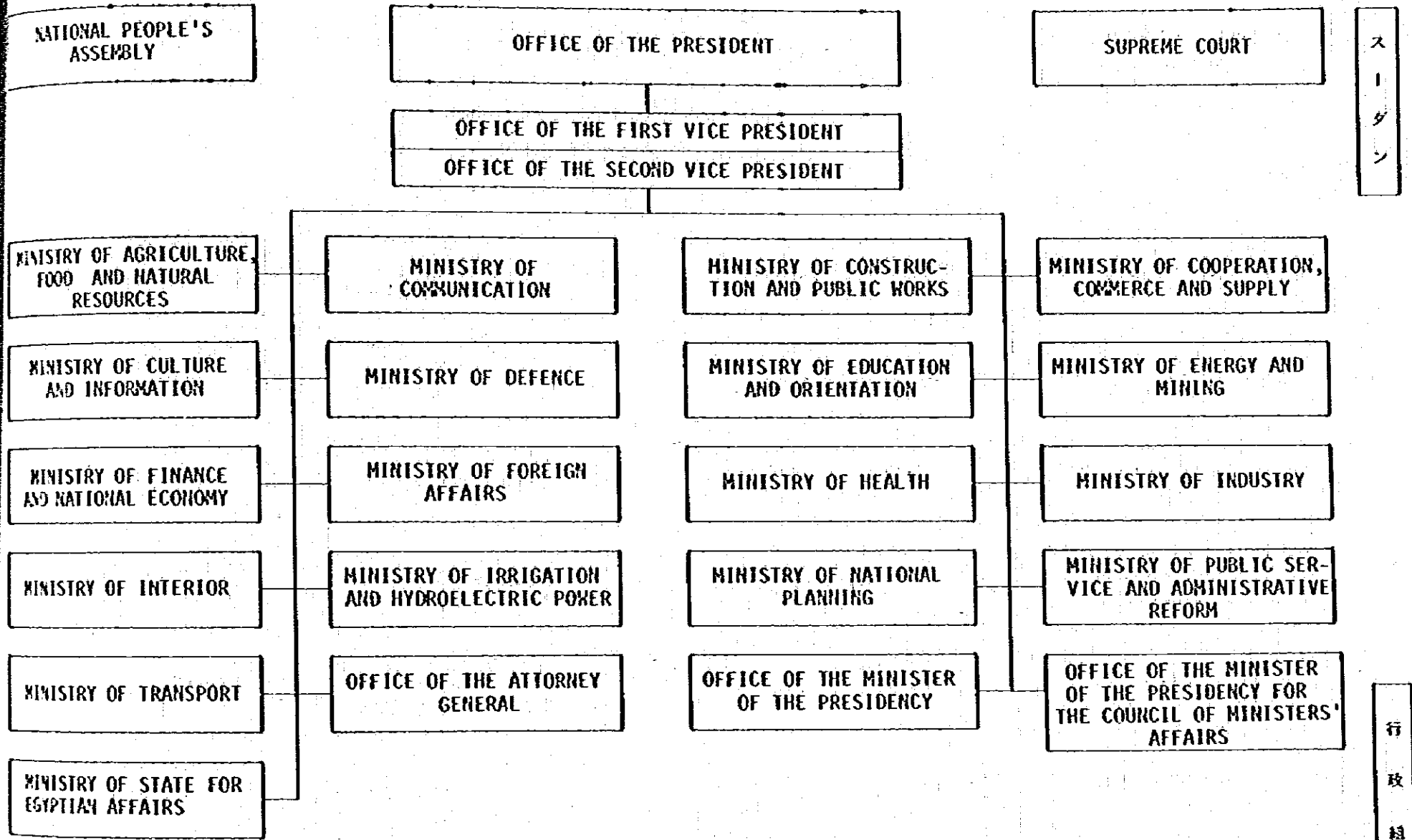

ス
ー
ダ
ン

行
政
組
織

シリア国政府行政組織図

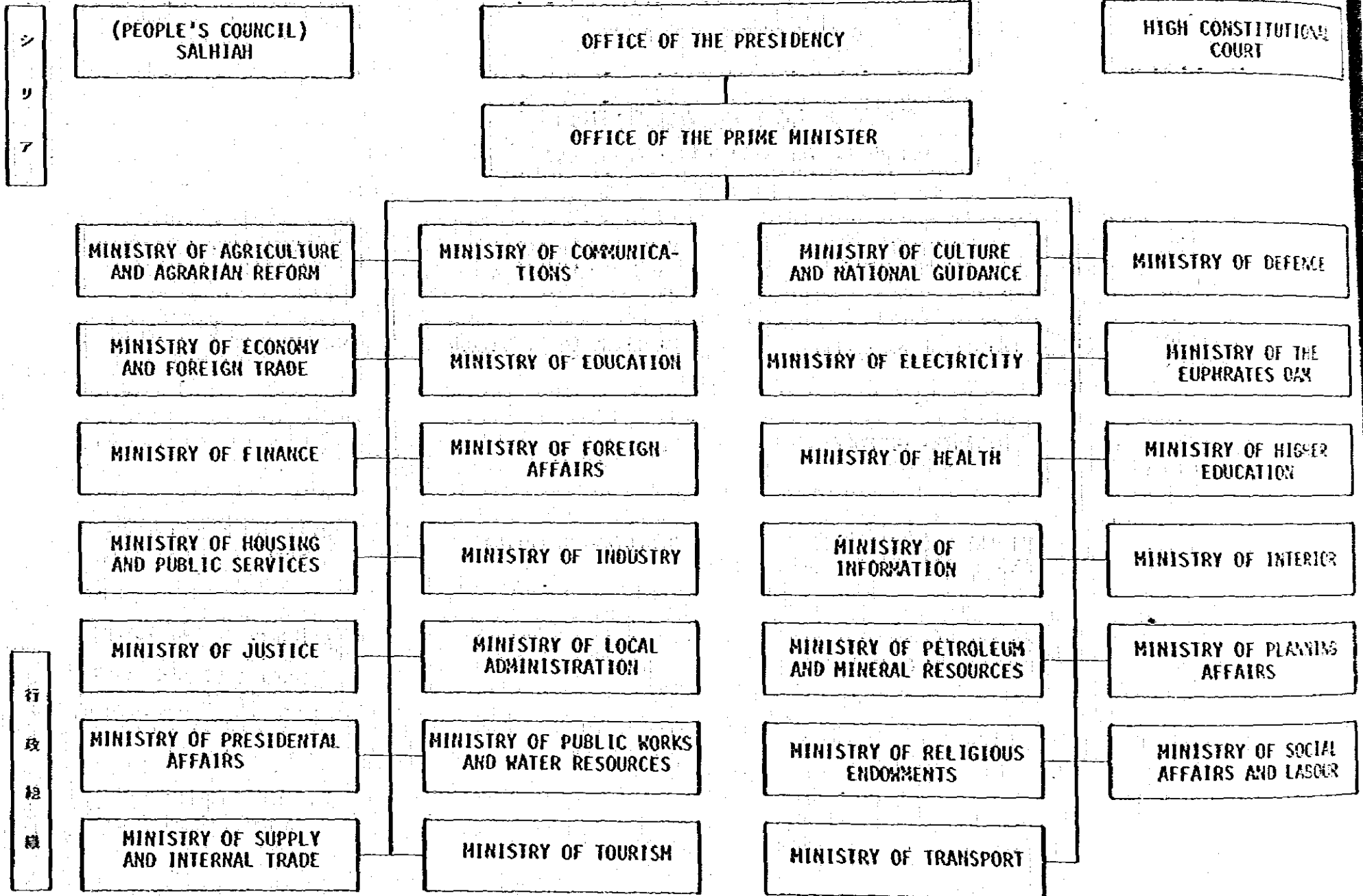

テニジア国政府行政組織図

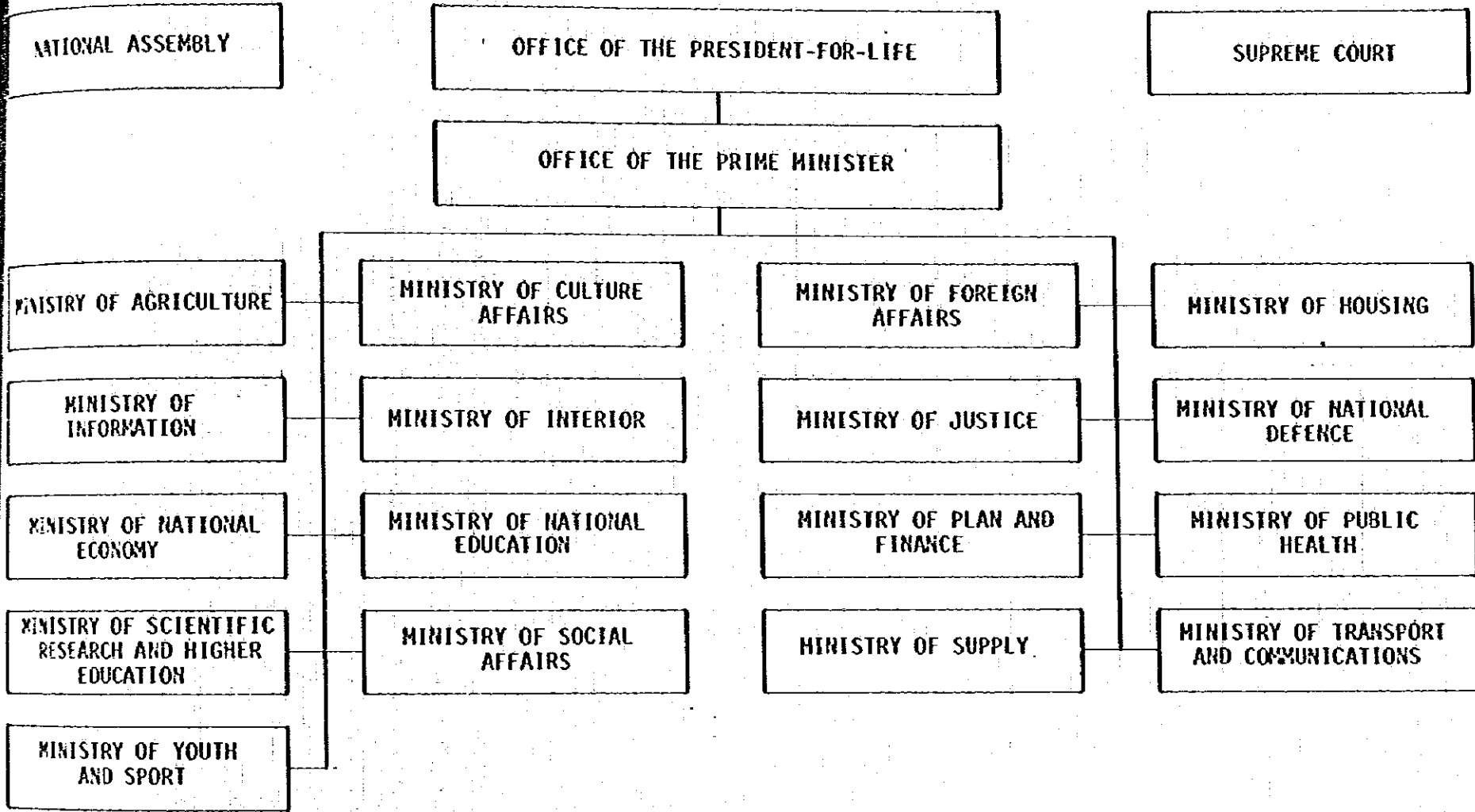

テニジア

行政組織

チュニジア共和国政府組織図（公文）

ORGANISATION DU GOUVERNEMENT TUNISIEN
LA REPUBLIQUE TUNISIENNE

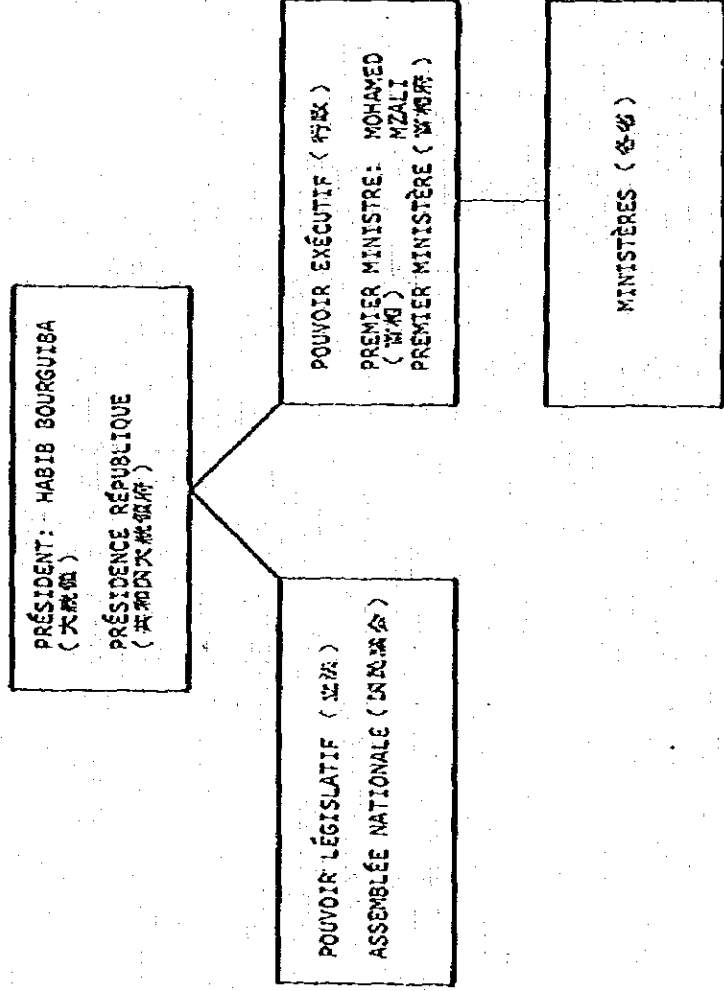

- 1 MINISTÈRE DE LA JUSTICE (司法省) POUVOIR JUDICIAIRE (司法) MHAMED CHAKER
- 2 MINISTÈRE DES AFFAIRES ÉTRANGÈRES (外務省) BÉJI CALD ESSEBSI
- 3 MINISTÈRE DE L'INTÉRIEUR (内務省) DRISS GUIGA
- 4 MINISTÈRE DE LA DÉFENSE NATIONALE (国防省) SLAHEDDINE BALLY
- 5 MINISTÈRE DE L'ÉCONOMIE NATIONALE (経済省) ABDELLAZIZ LASRAMI
- 6 MINISTÈRE DU COMMERCE (商売省)
- 7 MINISTÈRE DES INDUSTRIES-MINES ET ÉNERGIES (工業・鉱山・エネルギー省)
- 8 MINISTÈRE DE L'AGRICULTURE (農務省) LASSAËD BEN OSMAN
- 9 MINISTÈRE DE L'ÉDUCATION NATIONALE (文部省) FRAJ CHÉGLI
- 10 MINISTÈRE DE L'ENSEIGNEMENT SUPÉRIEUR ET DE LA RECHERCHE SCIENTIFIQUE (高等教育・科学研究省)
- 11 MINISTÈRE DE LA SANTÉ PUBLIQUE (衛生省) RACHID SFAR
- 12 MINISTÈRE DE L'ÉQUIPEMENT (設備省) MOHAMED SAYAH
- 13 MINISTÈRE DES AFFAIRES CULTURELLES (文化省) BÉCHIR BEN SLAMA
- 14 MINISTÈRE DE LA JEUNESSE ET DES SPORTS (青年スポーツ省) MOHAMED KRAIEM
- 15 MINISTÈRE DU PLAN ET DES FINANCES (経済計画・大蔵省) MANSOUR MOALLA
- 16 MINISTÈRE DES AFFAIRES SOCIALES (社会省) MOHAMED ENNACEUR
- 17 MINISTÈRE DE L'INFORMATION (情報省) TAHAR BELKHOJA
- 18 MINISTÈRE DES TRANSPORTS ET COMMUNICATIONS (運輸省) SADOQ BEN JEMMA
- 19 MINISTÈRE DE L'HABITAT (住宅省) MONCEFF BELMAJ AMOR

MINISTÈRE DE L'AGRICULTURE

