



Geological Survey Department
/ MNREM, Malawi



Japan International
Cooperation Agency

Project on Capacity Building in Mining Sector in Malawi

Drainage Geochemical Survey Manual

Version 2.0



March - 2016

Joint Venture

Sumiko Resources Exploration and Development Co., Ltd. (SRED)
Mitsubishi Materials Techno Corporation (MMTEC)

Contents

Introduction.....	1
1. Pre-field campaign planning.....	3
1-1. Survey area selection	3
1-2. Site planning	5
1-3. Health and Safety	13
1-4. Description sheet	18
1-5. Field equipment preparation	22
1-6. Working with stakeholders, farmers and local peoples	24
2. Field campaign	26
2-1. Access planning	26
2-2. Field demonstration	27
2-3. Daily field campaign procedure	29
2-4. Collecting drainage sediment samples	31
2-5. Field description	35
2-6. Management of unexpected field condition	39
2-7. Field sample checking, collation and storage	39
2-8. Field database	42
3. Analytical sample preparation	43
3-1. Sample drying and sieving	43
3-2. Sample splitting by conical quartering	43
3-3. Sample registration and packing	46
3-4. Dispatching to laboratory	48
3-5. Remain sample storage	52
4. Data interpretation	53
4-1. Data treatment-grouping	53
4-2. Histogram and threshold determination	54
4-3. Geochemical mapping	58
4-4. Multivariate analysis	60
4-5. Tools for geological interpretation	64
5. Reporting	68
6. References	69
Appendix	72

Introduction

Drainage geochemical survey in Malawi was proposed and carried out in 11 prospective areas selected by GSD/JICA team (SRED and MMTEC) in 2014-2015. The key to the project's success lies in the reliability and high quality of data produced which has been consistent over a long period of time. This manual has been achieved by the following procedures detailed here, which was arranged to adjust to Malawian geological-topographical-climatic-social environments from well-organized "G-BASE field procedure manual" edited by BGS (Britain Geological Survey, 2005). Although written essentially as instruction for internal use within GSD, this manual will also act as a basis for programming the nation-wide drainage geochemical mapping in Malawi.

Drainage samples have been collected for geochemical mapping, with the purpose of mineral exploration, as sediments from low order streams have demonstrably been a very effective "average" and representation of large areas of drainage catchment (Figure A, B and C). In-field quality assurance (QA, i.e. positioning, weighing, point selection and description) is enforced and trained under strict supervision by team leaders in whole procedure of sampling process (On the Job Training; OJT). Fine stream sediments (dry/wet) are sieved at site to $<500\mu\text{m}$ collected from low order streams, and sampling density is set, approximately, 1 sample per 5km^2 for regional-scale geochemical mapping.

The sampling campaign takes place during dry season, from May to November, having an advantage of better accessibility though some lowland area is too hot to work outside occasionally. Considering with the present degree of proficiency of staffs and survey equipment, two teams consisting of 4 members (team leader, counterpart, assistant and driver) respectively for 10-15 weeks (holiday in every 4 days) are supposed the optimum annual sampling schedule.

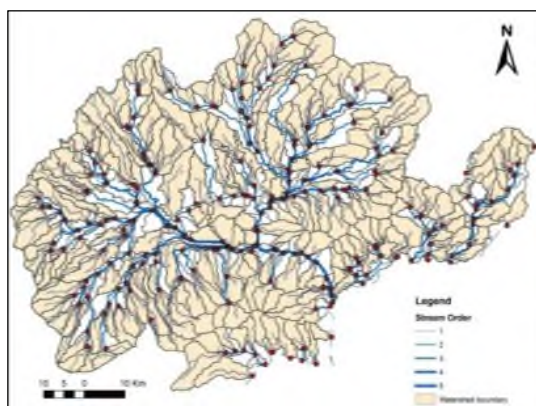

Figure A: Sampling sites and catchment distribution of lower stream order (from Shafique et al, 2014)

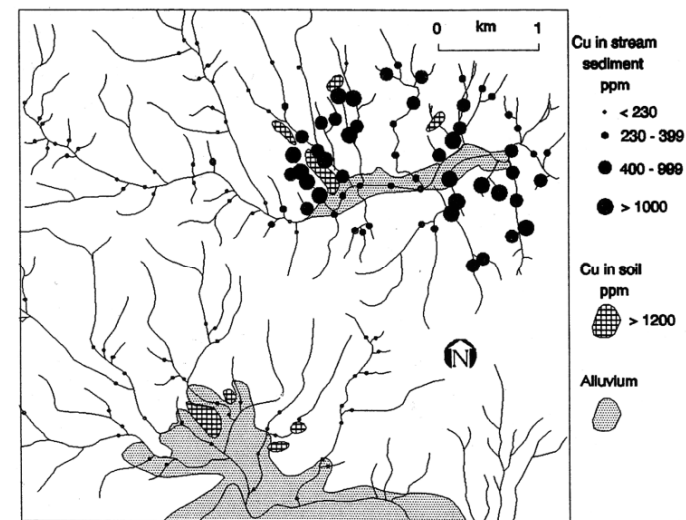

Figure B: An example of Cu dispersion by stream and soil samples (from Fletcher, 1997)

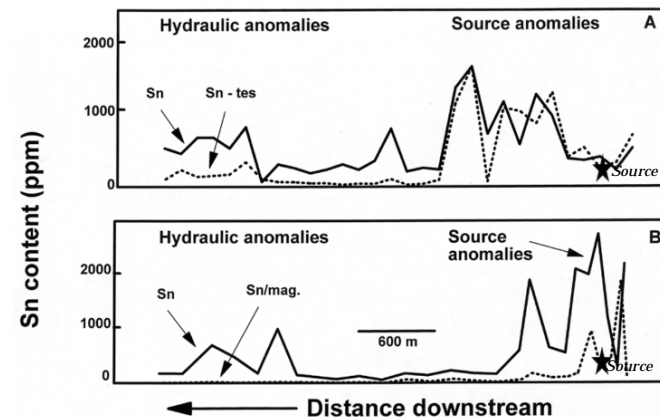

Figure C: Source and hydraulic Sn anomalies of stream sediments (from Fletcher, 1997)

1. Pre-field campaign planning

1-1. Survey area selection

Survey area selection has held well in advance of the commencement of the fieldwork. The 11 survey areas (Figure 1-2, Table 1-1) have been selected from 17 candidate sites primarily considering the prospective commodity and accessibility after bilateral meeting with GSD members. BGS (2009) documented 4 criteria of the commodity and associated lithological variations in Malawi, as shown below and Figure 1-1;

Commodity

Associated geology

- Rare earth metals, Coltan metals, nuclear metals and phosphate etc.----Alkaline magmatism
- Precious and Base metals, gemstones and industrial minerals-----Basement complex of metamorphic and igneous rocks
- Coal, Uranium, industrial minerals and gemstones-----Karoo and post-Karoo
- Bauxite, saprolitic Ni, Ti ± REE ± Zr, Au and gemstone placer, etc.-----Residual weathering, placer and rift-related sedimentation

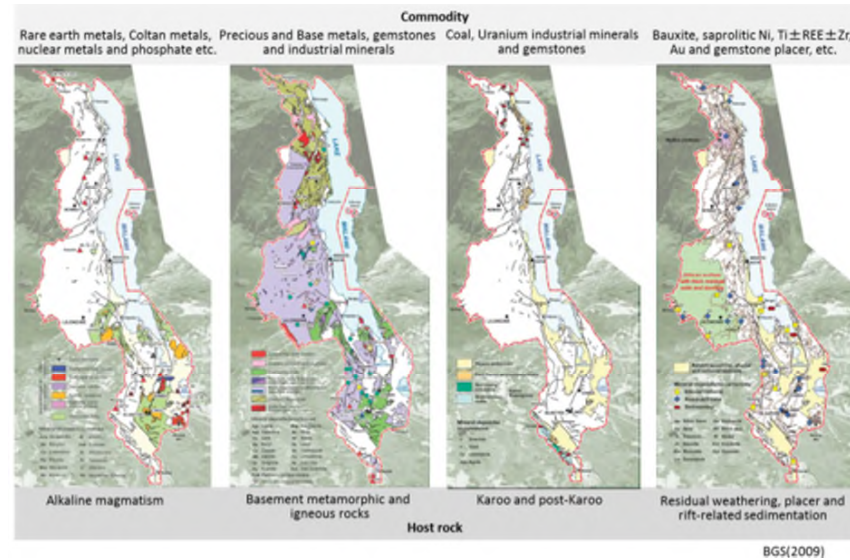

Figure 1-1 Commodity and associated rock variation in Malawi (from BGS, 2009)

Preliminary accessibility checking is important to optimize the fieldwork planning, i.e. programing the daily and whole working plans, the carriage-way and mountain path on the obtained stable base maps (cartographies of 1970's - 1980's) need to renewed using the latest satellite imagery of Google Earth. Based on the above mentioned items, the survey areas of GC01 to GC11 were selected (Table.

1-1 and Fig. 1-2).

Table 1-1 Geochemical survey area selection in Malawi (2014-2015)

Target No.	Area	Geology and Commodity		Prospecting licence	Accessibility			Preserved area	Recommendation	Evaluation
		Host rock	Occurrences		Location	Topography	Access, Steepness			
REE-1	900km ²	"Nepalin cycle": Syenogranite in Chitochoke public geos	-	Yes	South: Maching Zomba area	isolated steep mountains (500-1,000m)	Near, Hard	Malawi forest reserve	A	No
REE-2	900km ²	Syenogranite and Carbonate in public geos	REE	Yes	South: Phokondo-Mtanga area	isolated steep mountains (800-2,300m)	Far, Very Hard	Mtanga mountains forest reserve	B	No
REE-3	900km ²	Karoo sedimentary rocks and public geos	REE	Yes	South: Chikarawa westward 50km	mountains and valleys (200-1,000m)	Very Far, Hard	Mtanga wildlife reserve	B	No
REE-4	900km ²	Carbonate and granitic in public geos	-	Yes	South: Mangochi southwest ward 40km	low relief mountains (500-900m)	Near, Hard	-	A	Yes, 15GC08
REE-5	900km ²	Carbonate and granitic in public geos	REE	Yes	South: between Blaka & Pibiti	plains (200-800m)	Near, Moderate	-	AA	Yes, 15GC09
REE-6	450km ²	metamorphic pegmatite veins and granite vein in public geos	Be, Nb, Ta, U	Yes	North: around Mzimba	plains (1200-1600m)	Near, Easy	South Viphya forest reserve, B. park	GSD plan	14GC05
AI-1	900km ²	Public geos	Nb, Ta, U	Yes	Central: Kawango southwest ward 30km	plains (1,200m)	Far, Moderate	-	AA	Yes, 15GC06
AI-2	900km ²	Granitic stocks in public geos & Chitochoke site	-	Yes	South: Mangochi west 30km	low relief mountains (500-800m)	Near, Hard	-	A	Yes, 15GC08
AI-3	900km ²	Carbonate and Syenite stocks in public geos	As (Lampung)	Yes	South: Panku southwest 20km	plains mountains (800-1,200m)	Near, Hard	-	A	Yes, 15GC09
AI-4	900km ²	Porphyric complex in Chitochoke site	-	Yes	Central: Dula west 20km	plains mountains (1,400m)	Near, Moderate	-	AA	No
AI-5	900km ²	Public geos	As (Dawung)	Yes	Central: Nkhosakota northwest 50km	mountains and alluvial (500-1,100m)	Far, Hard	Nkhosakota wildlife reserve	C	No
AI-6	900km ²	Granitic stocks in public geos	-	Yes	Central: Nchi east 10km	mountains (800-1,400m)	Near, Moderate	Nchi forest reserve	AA	No
AI-7	200km ² 240km ²	Ramphe igneous complex-Nyika granite in post-orogenic basement	-	Yes	North: around Ramphe	mountains and basins (1,000-1,300m)	Near, Hard	Nyika national park	B	Yes, 14GC03 Yes, 14GC04
AI-8	900km ²	Public geos	As-placer	Yes	Central: Lilongwe south	mountains (1,000-1,700m)	Near, Hard	Dalungwe forest reserve (wildlife)	GSD plan	15GC07
BM-1	900km ²	Porphyric complex in Chitochoke and public geos	Ni, Cu, PGM	-	South: around Blangwe	mountains and valleys (80-1,200m)	Near, Hard	-	A	Pending, 15GC11
BM-2	900km ²	Public geos	Cu, Pb	Yes	South: east, around Ntanga	mountains and lowland (30-700m)	Near, Hard	-	B	Yes, 15GC10
BM-3	900km ²	Ultrabasic rock and granitic in Chitochoke site	-	Yes	Central: Lilongwe east 40km	plains and mountains (800-1,200m)	Far, Moderate	-	A	No
BM-4	200km ² 350km ²	Porphyric complex and magnetite/sulphide in post-orogenic basement	Nb, U	Yes	North: east, Chipinga north 20km	mountains and basins (1,000-1,700m)	Near, Moderate	-	A	Yes, 14GC01 Yes, 14GC02
BM-5	900km ²	Granitic and magnetite in post-orogenic basement	U	Yes	North: Karonga west 40km	mountains (700-1,600m)	Far, Hard	-	B	No



Figure.1-2 Geochemical survey areas (11 areas) in Malawi (2014-2015)

1-2. Site planning

In the case of drainage geochemical survey for regional mineral exploration, site planning should be organized, fundamentally, 1) sampling density determined evenly by watershed units within the survey area, 2) surrounding positioning for prospective lithological units or economic mineral occurrences such as carbonatite, syenite and granitic intrusion, 3) site correspondence to independent watershed/catchment to delineate a certain anomalous area on geochemical mapping.

1) Sampling density

After the stream order/network classification, it can be delineated the watershed in adequate size; around 5 sq. km which are second to third order streams in our survey area, generally. The sediments are transported along these streams, which are weathered materials from the source rocks in respective watersheds. Hence the mouths/outlets of these watersheds are proposed as sites to collect stream sediment samples for subsequent geochemical analysis aiming for mineral exploration. The number of sample to be collected is proposed in each survey area. The spatial locations (geographic coordinates) of the planned sites are shared with the sampling teams to assist them in the field.

Note-1: Stream order

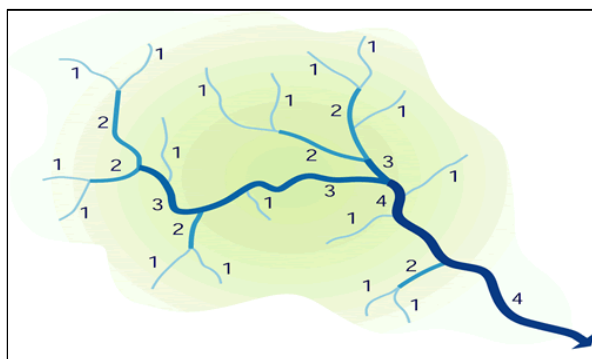

- Stream order classification -

Classifying Stream Orders:

Stream order is a method for classifying the relative location of a reach within the larger river system. This system shown here is the Strahler (1957) modified Horton (1945) method for stream order, which assigns each headwater perennial stream an order of 1, and then at the confluence of two 1st-order Streams assigns the downstream reach an order of 2. In this method, the confluence of two 2nd-order streams results in a downstream reach of order 3, and so on....., as illustrated by above figure. (http://www.fgmorph.com/fg_4_8.php)

Note-2: Stream type simple classification

a) Straight streams



- Straight stream oblique pattern and dimension/section -

Straight channels are the first of a simple three part classification by early geomorphologists, as reported by Leopold, Wolman and Miller (1957) and Schumm (1977).

The images above show the oblique view and cross sectional view of a relatively straight channel. The oblique view reveals the relatively steep valley slope associated with this natural stream type. Many human constructed channels are straight and without step-pool sequences, thereby increasing the efficiency of moving flood waters from the area, but likely causing downstream scour due to excessive energy and shear forces. Often streams of this straight class are in the headwater areas, and dissipate hydraulic potential energy through a series of high friction steps and scour pools. Straight channels are considered relatively stable.

b) Meandering streams

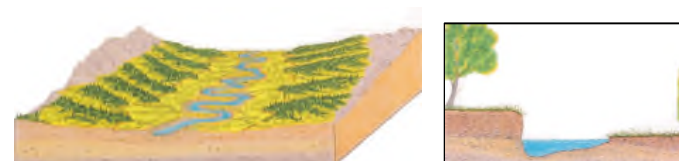

- Meandering stream oblique pattern and dimension/section -

Meandering channels are the second of a simple three part classification by early geomorphologists, as reported by Leopold, Wolman and Miller (1957) and Schumm (1977).

These images show the oblique view and cross sectional view of a meandering channel with a wide meander belt width. The cross sectional dimension view illustrates the cut-away bank with a deep pool and the opposite point bar slope grading into the flood plain. Often streams of this nature are in the gentler sloping and wide valleys, where the stream can laterally migrate across the valley, eroding floodplain on the cut-bank side, and building floodplain on the point bar side. The meanders help the stream to dissipate hydraulic potential energy through scour and turbulent eddies. Meandering channels are considered intermediately stable with semi-cohesive bank material, moderate bed load and suspended sediment.

c) Braided streams



- Braided stream oblique pattern and dimension/section -

Braided channels are the third of a simple three part classification by early geomorphologists, as reported by Leopold, Wolman and Miller (1957) and Schumm (1977).

These above images show the oblique view and cross sectional view of a braided channel with multiple parallel channels. The oblique view showing vegetated central bars suggests that this stream class describes channels with islands, however islands can also appear in meandering channels. Further, some braided channels have unvegetated, and highly mobile central bars. These systems can be formed due to excessive upstream head-cuts or bank failure which generates sediment pulses (degradation) and then a downstream flattening of slope, loss of hydraulic energy, and localized sediment aggradation. Braiding channels are considered relatively unstable with non-cohesive bank material and predominantly bed load sediment.

Note-3: River stream classification by morphology

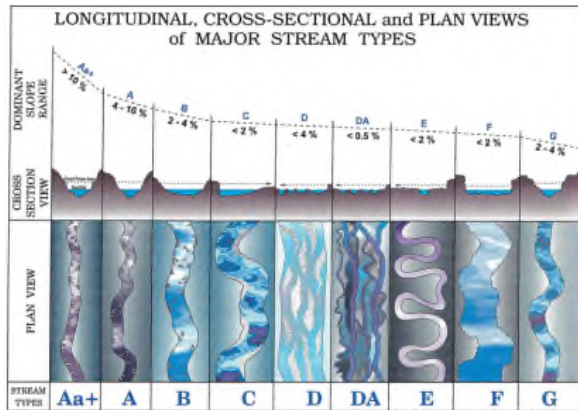

- Classification by Pattern, Profile and Dimension/Section by Rosgen -

Rosgen classification by Pattern, Profile and Dimension:

Rosgen classification can be simplified to pattern, profile, and dimension graphical analysis, as shown in above figure without identification of bed material.

Pattern is shown in the plan view, illustrating relatively straight channels on the left, increasingly sinuous and wider channels next, followed by threaded and braided channels in the center, and then highly sinuous channels, wider channels, and relatively narrow channels.

Dimension is shown in the cross section view, which illustrates water surface in blue at bank-full elevation, and a dashed line at two-times bank-full or the flood prone elevation. The ratio of these two lines gives the entrenchment of the channel. On the left the chart begins with a relatively low entrenchment ratio which denotes highly entrenched channels. In the center, the entrenchment ratio increases, indicating moderate entrenchment.

Profile is shown in the dominant slope range view, which plots average or typical longitudinal slopes along the bank-full water surface. On the left, type A and B streams (see figure of previous page) have steep slopes, while in the center slopes are gentle. On the far right, for G streams, slopes once again are typically higher.

Note-4: River stream classification by sediment type

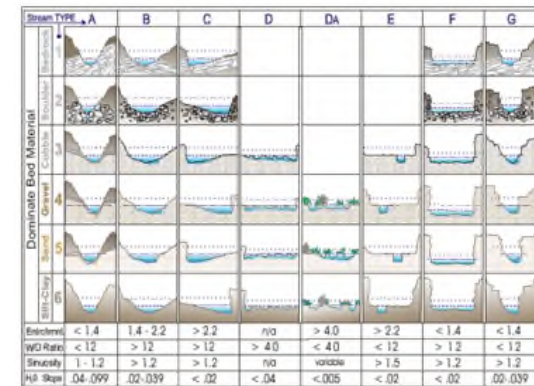

- Rosgen cross section views with substrate -

Rosgen Classification by Bed Material:

Cross sectional, or dimension, views of the Rosgen Reach classes are shown in above diagram. Note that the bedrock and coarser sediment types are not represented in the D, DA, and E-type channels.

Dimension illustrations reveal how the various substrate materials, along with the channel reach type, tend to influence the cross section shape. Some substrates create more angular shapes, while other substrates allow for more curvilinear features. Typical values and ranges

for entrenchment, width to depth, sinuosity, and slope are also given. It should be noted that FGM (Fluvial Geomorphology Module) values measured in the field may depart from this illustration.

Note-5: Watershed delineation

The following procedure and example will help you locate and connect all of the high points around a watershed on a topographic map shown in Figure below. Visualizing the landscape represented by the topographic map will make the process much easier than simply trying to follow a method by rote.

1. Draw a circle at the outlet or downstream point of the wetland in question (the wetland is the hatched area shown in Figure to the right)
2. Put small "X's" at the high points along both sides of the watercourse, working your way upstream towards the headwaters of the watershed.
3. Starting at the circle that was made in step one, draw a line connecting the "X's" along one side of the watercourse (Figure, below left). This line should always cross the contours at right angles (i.e. it should be perpendicular to each contour line it crosses).
4. Continue the line until it passes around the head of the watershed and down the opposite side of the watercourse. Eventually it will connect with the circle from which you started. At this point it has delineated the watershed of the wetland being evaluated.

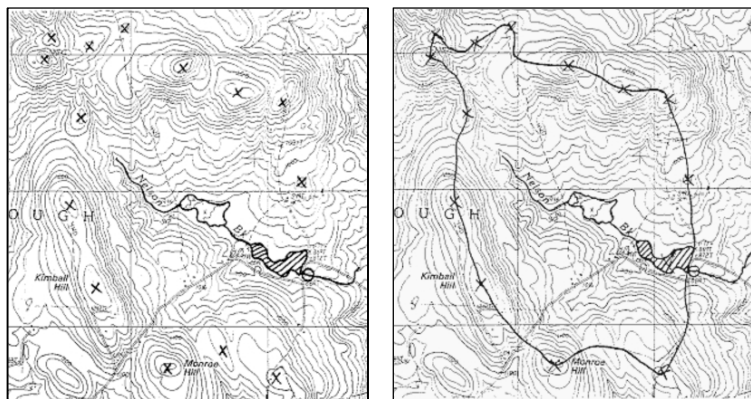

- Delineating watershed; step-1(left) and step-2(right) -

The delineation appears as a solid line around the watercourse. Generally, surface water runoff from rain falling anywhere in this area flows into and out of the wetland (hatched area). This means that the wetland has the potential to modify and attenuate sediment and dissolved substance loads from this watershed as well as to store runoff which might otherwise result in downstream flooding. See also Figure A in the introduction page of this manual.

2) Surrounding position of the prospective lithological units

For identifying regional geochemical anomalies through GIS mapping, several visualization styles are available with the same geochemical data sets as shown in Figures 1-3 a), b) and c). Thus the site planning should include the accentual-strategic site positioning around the prospective lithology.

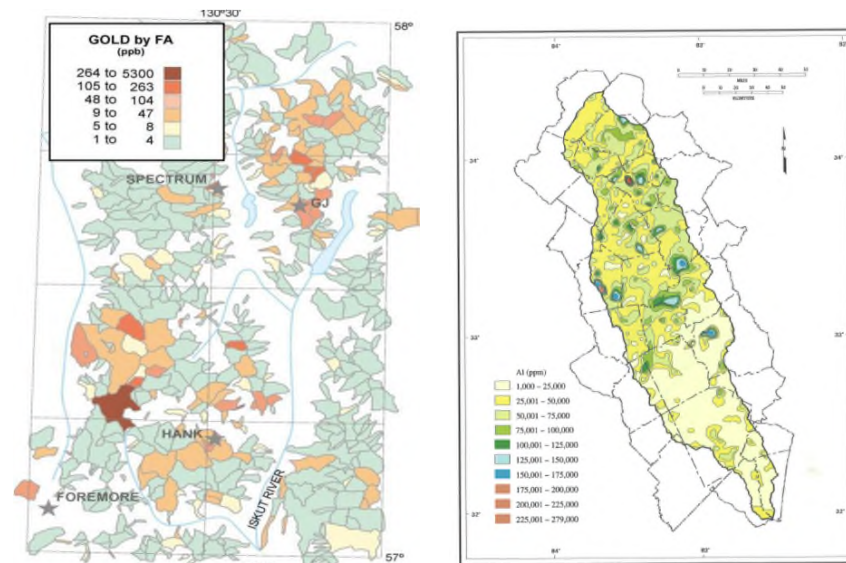

a) Catchment-Basin mapping (Anand, 2014)

b) Contour mapping (Cocker, 1996)

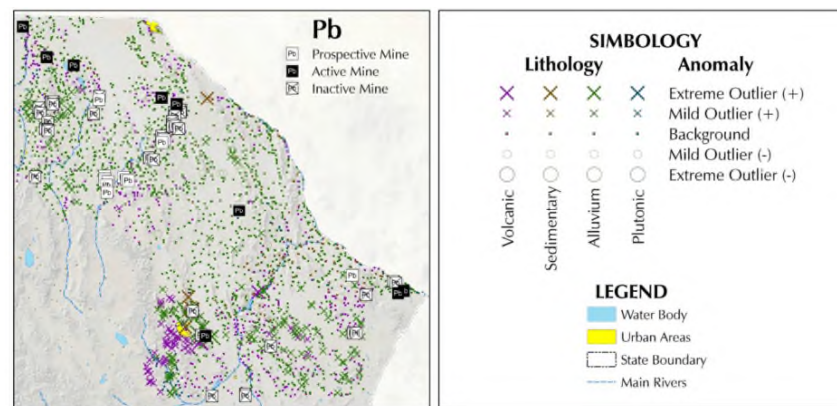

c) Symbology mapping (Gutiérrez et al., 2014)

Figure 1-3 Geochemical anomaly visualizations by stream sediments

3) Site correspondence to independent watershed/catchment

The delineated watersheds of streams of survey area and the mouths/outlets of the streams are proposed as the appropriate sites for the collection of stream sediments samples.

4) Practical site planning

It is important to consult the stable base maps from adjacent areas in order to establish the sampling boundary for the new field campaign. After collecting published geologic-topographic maps (scanned in GSD, Zomba) and GIS data of drainage network (Department of surveys, Lilongwe), they are loaded and compiled onto Geographic Information System (ArcGIS10.2.2) for precise positioning of site planning (Figure 1-4).

Detailed planning is carried out in advance of fieldwork, which is essential in order that field accommodation and sampling boundaries can be identified. The total number of samples to be collected from the area must be calculated accurately in order to adjust to the duration of the field work and to sub-divide the area efficiently, for respective survey teams. Average sampling rate seems to be 6 samples / day / team on working day due to the first year achievement, so that the total number and the area to be covered can be estimated. This has to be taken into account to: days for anticipated visit with written official letter of GSD for receiving permissions to the local authorities, district officers and some estates to be aware of our purpose and activity of the survey, as well as the training period, holidays and an accommodation move (Table 1-2).

Site planning results are compiled on flat, coloured copies of the relevant 1:50,000-1:100,000 maps created by ArcGIS (Figure 1-5). Black and white maps are not suitable for this purpose, as different topographic-geologic features are distinguished by colour. Sampling sites should be planned at an average of 1 sample per 5 sq. km of catchment area where surface drainage is well defined. Selected sites should be located, ideally, on lower order stream (in fact, second to third order streams to require the sampling density) and on upstream of river junctions of two even catchment area for effective survey. Care must also be taken to locate sites upstream of confluences to minimize effects caused by sediment mixing and upstream dispersion. For the same reason, the vast alluvial plain-fan or fan delta area, where surface drainage is braided or not defined, also should be eliminated from site planning.

In case of plural sampling team operating from a different field base, then once all planning has been undertaken, and boundaries established, a set of duplicate maps must be prepared to ensure that different field teams understand the sub-division of sampling areas.

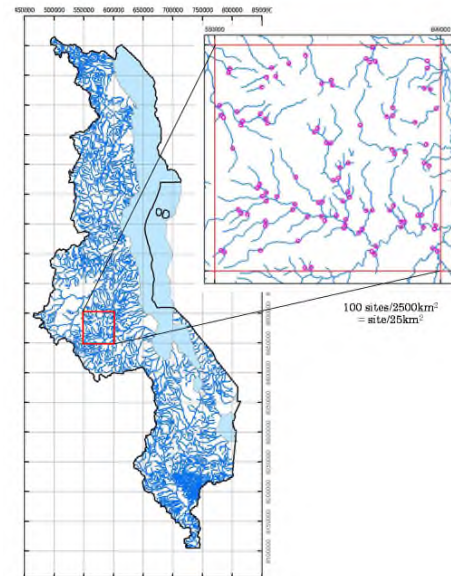

Figure 1-4 Spatial site planning example of drainage geochemical survey

Table 1-2 Planned itinerary of drainage geochemical survey (2014)

Date	Activity	Contents	Geographic location	Day	ACM	Others	Accommodation	Meal	Transportation	Remarks
14 Oct	S	MOI (1) 650 SRK (2) 650								
15 Oct	M	MOI (2) 650 SRK (3) 650 (1) W (1) 250								
16 Oct	T	MOI (3) 650 SRK (4) 650 (2) W (2) 250								
17 Oct	F	MOI (4) 650 SRK (5) 650 (3) W (3) 250								
18 Oct	S	MOI (5) 650 SRK (6) 650 (4) W (4) 250								
19 Oct	M	MOI (6) 650 SRK (7) 650 (5) W (5) 250								
20 Oct	T	MOI (7) 650 SRK (8) 650 (6) W (6) 250								
21 Oct	F	MOI (8) 650 SRK (9) 650 (7) W (7) 250								
22 Oct	S	MOI (9) 650 SRK (10) 650 (8) W (8) 250								
23 Oct	M	MOI (10) 650 SRK (11) 650 (9) W (9) 250								
24 Oct	T	MOI (11) 650 SRK (12) 650 (10) W (10) 250								
25 Oct	F	MOI (12) 650 SRK (13) 650 (11) W (11) 250								
26 Oct	S	MOI (13) 650 SRK (14) 650 (12) W (12) 250								
27 Oct	M	MOI (14) 650 SRK (15) 650 (13) W (13) 250								
28 Oct	T	MOI (15) 650 SRK (16) 650 (14) W (14) 250								
29 Oct	F	MOI (16) 650 SRK (17) 650 (15) W (15) 250								
30 Oct	S	MOI (17) 650 SRK (18) 650 (16) W (16) 250								
31 Oct	M	MOI (18) 650 SRK (19) 650 (17) W (17) 250								
1 Nov	T	MOI (19) 650 SRK (20) 650 (18) W (18) 250								
2 Nov	F	MOI (20) 650 SRK (21) 650 (19) W (19) 250								
3 Nov	S	MOI (21) 650 SRK (22) 650 (20) W (20) 250								
4 Nov	M	MOI (22) 650 SRK (23) 650 (21) W (21) 250								
5 Nov	T	MOI (23) 650 SRK (24) 650 (22) W (22) 250								
6 Nov	F	MOI (24) 650 SRK (25) 650 (23) W (23) 250								
7 Nov	S	MOI (25) 650 SRK (26) 650 (24) W (24) 250								
8 Nov	M	MOI (26) 650 SRK (27) 650 (25) W (25) 250								
9 Nov	T	MOI (27) 650 SRK (28) 650 (26) W (26) 250								
10 Nov	F	MOI (28) 650 SRK (29) 650 (27) W (27) 250								
11 Nov	S	MOI (29) 650 SRK (30) 650 (28) W (28) 250								
12 Nov	M	MOI (30) 650 SRK (31) 650 (29) W (29) 250								
13 Nov	T	MOI (31) 650 SRK (32) 650 (30) W (30) 250								
14 Nov	F	MOI (32) 650 SRK (33) 650 (31) W (31) 250								
15 Nov	S	MOI (33) 650 SRK (34) 650 (32) W (32) 250								
16 Nov	M	MOI (34) 650 SRK (35) 650 (33) W (33) 250								
17 Nov	T	MOI (35) 650 SRK (36) 650 (34) W (34) 250								
18 Nov	F	MOI (36) 650 SRK (37) 650 (35) W (35) 250								
19 Nov	S	MOI (37) 650 SRK (38) 650 (36) W (36) 250								
20 Nov	M	MOI (38) 650 SRK (39) 650 (37) W (37) 250								
21 Nov	T	MOI (39) 650 SRK (40) 650 (38) W (38) 250								
22 Nov	F	MOI (40) 650 SRK (41) 650 (39) W (39) 250								
23 Nov	S	MOI (41) 650 SRK (42) 650 (40) W (40) 250								
24 Nov	M	MOI (42) 650 SRK (43) 650 (41) W (41) 250								
25 Nov	T	MOI (43) 650 SRK (44) 650 (42) W (42) 250								
26 Nov	F	MOI (44) 650 SRK (45) 650 (43) W (43) 250								
27 Nov	S	MOI (45) 650 SRK (46) 650 (44) W (44) 250								
28 Nov	M	MOI (46) 650 SRK (47) 650 (45) W (45) 250								
29 Nov	T	MOI (47) 650 SRK (48) 650 (46) W (46) 250								
30 Nov	F	MOI (48) 650 SRK (49) 650 (47) W (47) 250								
1 Dec	S	MOI (49) 650 SRK (50) 650 (48) W (48) 250								

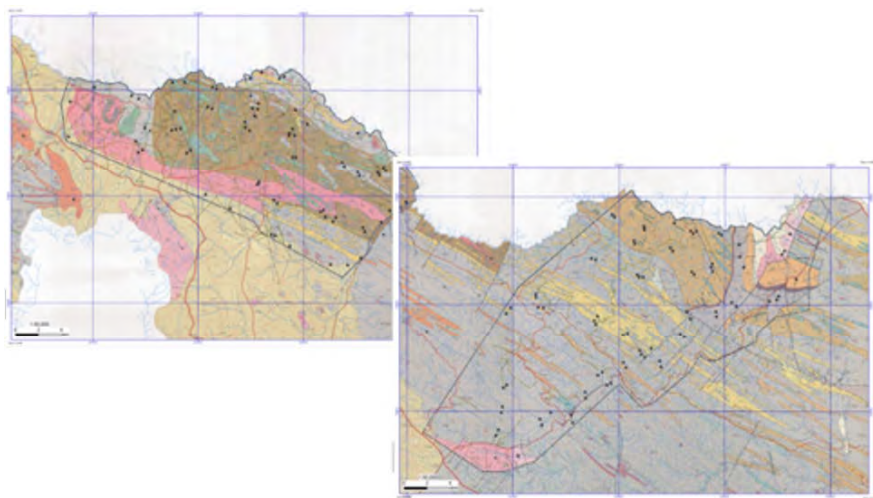

Figure 1-5 Geochemical site plans on geologic map (GC01-02, 2014)

1-3. Health and Safety

Health and Safety (H&S) is an integral part of all survey procedures and any activity considered to be of medium to high risk to health and safety is investigated by a risk assessment. It is a requirement that all staff should share the knowledge, and if any incident or accident occurs, it should be treated safely, then quickly should be informed to responsible personnel of the survey team and related organizations.

(1) Safety

A summary of the medium/high risk activities in the field and measures to reduce risks is given in Table 1-3. The overriding principle of Health and Safety measures is that we have a duty to safeguard our own health and safety, those with whom we work and those on whom our work impacts. The main measure to reduce risks is training and all staff working in the field should learn:

- first aid at fieldwork
- driving 4x4 vehicles (on and off road)

(2) Health

Field team leaders must be made aware (in confidence) of any health issues affecting members of their team (food allergies, health problems etc.) and such information should be requested by team leaders prior to the commencement of fieldwork. Leaders must also have readily available a list of emergency contact numbers both for personnel, the local area (e.g. Police) and work (e.g. contact for

senior managers). For medical advice team leaders should be aware of the phone number of nearest reliable hospitals (Figure 1-6).

In addition to the summarized risks, all fieldworkers should communicate daily well to know and share the member's condition and to avoid a coming difficulty for completing the field campaign. If unexpected scene took place, the team leader should employ measures suited to the occasion.

(3) Security

The security of sampling teams is H&S issue because of the danger of terrorists or activists when working in sensitive areas. Sensitive areas (e.g. power stations, water reservoirs, international borders, forest reserve etc. which are indicated by local police officers or district officers) must be clearly identified before fieldwork commences and samplers must be made aware of where these areas are by the team leader. A list of sensitive areas should appear in the end of campaign report. If samplers are challenged they must be carrying a hard copy of GSD letter (Figure 1-7) to identify themselves. It is essential that the GSD headquarter office have a list of all members and mobile phone numbers.

It is impossible to predict the exact survey route which samplers may take in a day, but samplers will mark on the map where they will start and finish and the team leader should be aware of the order of samples to be collected.

Table 1-3 Summaries of high/medium risks in fieldwork and measures to reduce risks

High/Medium risk activity	Summary of measures to reduce risk
Driving in field area	<ul style="list-style-type: none"> • receive appropriate vehicle driving training • use vehicle appropriate for type of fieldwork • keep low velocity in/around housing area and urban area • ensure the road condition of wet/sandy river path before crossing to avoid stuck, as well as wooden bridge, eroded mountain path and prepare shovel-bush knife to escape
Transporting heavy loads and equipment by vehicle	<ul style="list-style-type: none"> • do not overload vehicles • secure equipment and samples
Lifting heavy loads/ loading and unloading samples	<ul style="list-style-type: none"> • receive manual handling training • use appropriate plastic container for sample transportation • don't overload storage plastic container • do not load/unload heavy items alone
Carrying heavy loads in the field	<ul style="list-style-type: none"> • use good quality rucksacks offering high level of support and adjusted appropriately for the carrier • share the load between the two samplers • sensible handling of load while negotiating obstacles (e.g. pass load across a stone stepped river with rucksack still on)
Drainage sampling	<ul style="list-style-type: none"> • attend sampling training-demonstration day • dress appropriately with good footwear and always take long sleeved clothing and cotton gloves • stick to recognised paths. Do not take risks crossing barbed thick bushes/rocky cliff/insure wet river floor or slippery rounded rock/streams for the sake of making a shortcut
Walking on country roads	<ul style="list-style-type: none"> • always use Hi-vis jackets and rucksacs with Hi-vis strips • seek alternative footpaths if available • walk into oncoming traffic except when approaching the brow of a hill
Remote working	<ul style="list-style-type: none"> • always sample in pairs • inform team leaders of proposed route and return time • carry emergency telephone numbers
Adverse weather	<ul style="list-style-type: none"> • pay attention to weather forecasts • do not sample areas in times of flood • take appropriate measures against exposure to the sun • during thunderstorms follow standard procedures to avoid lightning strikes and in particular don't carry a metal shovel / hammer
Attack by animals and dangerous plants	<ul style="list-style-type: none"> • avoid potentially dangerous animals (e.g. bulls, unchained dogs, alligator, snake, puma, monkey, but etc.) by whistle or cow-bell where possible by choosing an alternative route, and insects (e.g. particular ant, mosquito, tick etc.) by anti-insect spray • keep communication with counterpart on hazardous animals and local hazardous plants (buffalo beans etc.)
Forest and wildlife reserve, military area and other hazardous land use	<ul style="list-style-type: none"> • always have permission to enter such areas first • team leaders to advise samplers of such potential areas on their map • team leaders plan daily sampling areas so hazards such as large rivers or railways do not have to be crossed • always wear Hi-vis jackets and rubber coated gloves and cap
Exposure to infection	<ul style="list-style-type: none"> • samplers to be advised of dangers on training day • avoid cattle contaminated ponds or fields being sprayed • keep clean and use insecticide to avoid malaria infection in accommodation

- 9/52 -

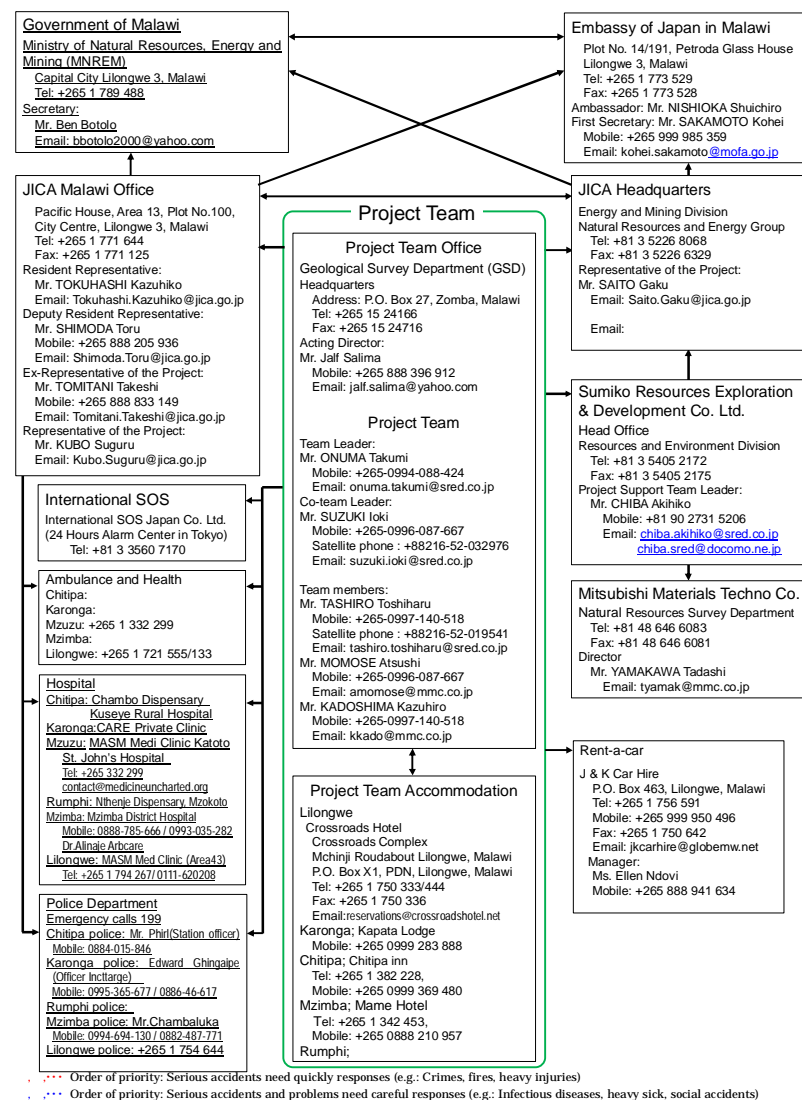

Figure 1-6 Information network on health and safety in the field campaign (2014)

Appendix 3-6

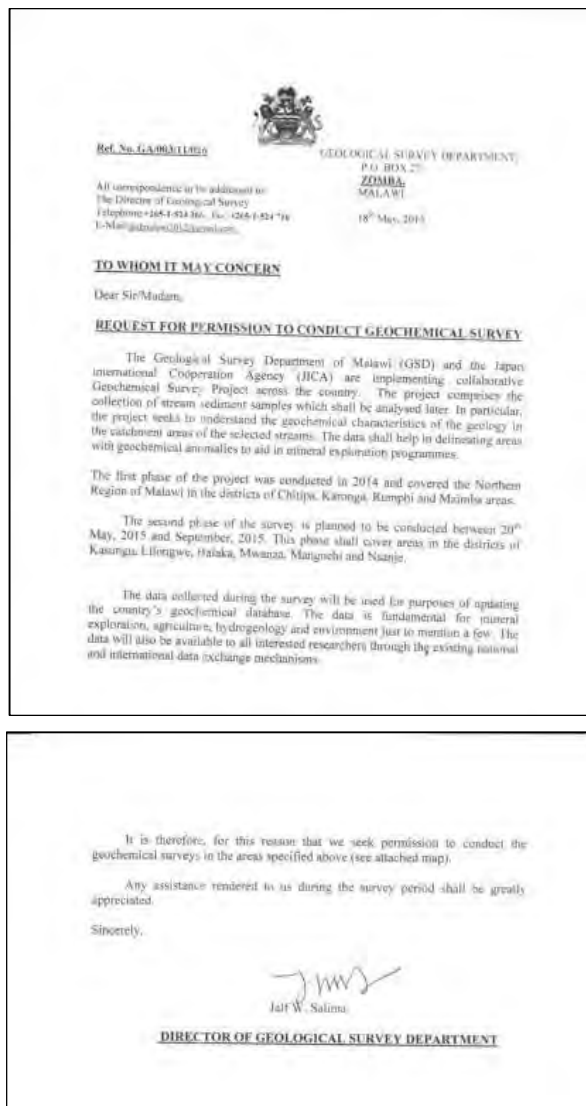

Figure 1-7 GSD official letters to request for permission to conduct geochemical survey (2015)

1-4. Description sheet

To describe field data for regional geochemical survey, it is considered principally to record the site and sampling information with all effective factors on chemical analysis result, such as A) date, B) location data, C) drift and drainage type, D) land use and vegetation, E) clast state, F) geology, G) probable contamination agent and H) photographic records as shown in description sheet (Figure 1-8).

The primary method of data collection in the field is a hardcopy record referred to description sheet mentioned above. Through the initial demonstration period, additional frequent instruction at site (OJT) and the diligent validation of description sheets and maps, team leaders ensure a high level of consistency and accuracy are achieved.

1. Description cards are numbered prior to fieldwork commencement.
2. At the start of each day sampling teams are issued with a set of description cards corresponding to the number of sites to be sampled. The sampling team allocates the site number on arrival at site based on the next numbered blank description sheet to be used. This number is transcribed onto all sample bags and the field map at the site.
3. The description sheets are completed at site using a blue/red biro (ball-point pen), and all columns should be completed on location.
4. The sampling team responsible for collecting the samples is identified by their initials on the description sheet (e.g. BS-1; first sample in area B by Mr. Suzuki's team). The individual responsible for completing the description sheet lists their name first.

The most common problem that counterparts face when completing description sheet comes from unfamiliarity with the abbreviations to be used (e.g. Bt: biotite, Gr: granite, Gn: gneiss etc.). This can be overcome by providing acceptable abbreviations in the below part of the sheet, and additional copy of geologic map legend in hand carrying file box. To reduce the amount of free-text description, which is occasionally hard to decipher or understand, and to eliminate errors on descriptive completion the description sheet provides multiple-choice to be selected for almost columns. But it is still important the additional information written by free-text, such as lateritic or magnetic particle occurrence in sediments, on description sheet to be understood and interpreted well the description records for remote survey team.

Common errors are due to transcription mistakes, especially when copying the coordinates by GPS (Arc-1950 or WGS-1984) onto the description sheets. All data stored in the GPS are checked by team leaders at the field base, against the information on the field cards to eliminate location data errors. GPS coordinates may have a much lower precision when used in deep incised valley or in woodlands. In such an instance the margin error value of positioning correctness should always be recorded.

Occasionally the wrong sample number may be written onto all the sample plastic bags. This can happen for a number of reasons. This mistake will be made obvious and can be rectified when samples are checked in at the field base in a day off.

Photograph-1: Completing a description card at site



Photograph-2: Taking a digital picture at sampled site



Photograph-3: Site location is recorded using a GPS



Photograph-4: Starting from field base (lodge) in Mzimba



Photograph-5: Waiting in a safe place for passing a heavy squall



Photograph-6: Temporal sample storage in GSD Lilongwe
(Big container: remaining samples, Small container: samples to analyze)



Description Card of Drainage Geochemical Survey (2014) ver.1.3(2)

A	Survey Area: 14GC01, 14GC02, 14GC03, 14GC04, 14GC05	Collector:
	Site No.:	Date & Time:
	Weather Condition: Clear, Cloudy, Rainy, (Stormy)	
B	UTM-easting: (GPS reading, ARC1950)	Planned UTM-E:
	UTM-northing: (GPS reading, ARC1950)	Planned UTM-N:
	Elevation: m (GPS reading)	
C	Drift types: 1)Alluvium, 2)Coarse Gravel, 3)Soil, 4)Marsh, 5)Clay, 6)Scree(Talus), 7)Made Ground	
	Drainage types: 1)Dry, 2)Wet, 3)Seepage, 4)Ditch(Waterway), 5)Drains, 6)Small stream(<3m), 7)Stream(3-10m), 8)Small river(10-33m), 9)River(33m<)	
	Drainage-Sediment conditions: 1)Dry-sand/gravel bar, 2)Ponded with dry sections, 3)Low flow, 4)Moderate flow, 5)Strong flow, 6)Channel filled bank to bank, 7)Overflow-bank burst, 8)Spate(Flood)	
	River name[] , Drainage Order: [1, 2, 3, 4] Additional Comments on Locality:	
D	Land use: 1)Coniferous Forest, 2)Deciduous Forest, 3) Sparse forest in burned-off field, 4)Small Pit-Pan Mining, 5)Quarrying, 6)Gravel Pit, 7)Rough Grazing, 8)Arable(Maize, Tobacco, Cassava, Cotton, Millet, Sorghum, Groundnuts, Coffee, Tea), 9)Pasture, 10)Heather, 11)Forest or Wildlife Reserve, 12)Industrial(Type:)	
E	Clast Precipitates Colour: 1)Orange, 2)Brown, 3)Black, Clast Precipitates Abundance: 1)Light, 2)Moderate, 3)Heavy	
	Sediment Colour: 1)White, 2)Grey, 3)Light Brown-Orange, 4)Dark Brown-Black	
	Sediment Composition: Clay [1]Low clay, 2)Moderate clay, 3)High clay], Organics [1]Low organics, 2)Moderate organics, 3)High organics]	
F	Catchment Geology Description(from published geological map):	
	Site Geology(within 100m of site) Description:	
	Outcrops(within 100m of site): 1)No, 2)Minor, 3)Moderate, 4)Abundant	
	Clast Lithologic Composition(descending abundance):	
	Mineralization style in bedrock: 1) None, 2)Vein, 3)Fault, 3)Pod, 4)Lens, 5)Stratiform, 6)Joint or Fracture, 7)Disseminated, 8)Staining or Coating	
G	Possible Site Contamination: 1)Manufactured Metal, 2)Iron-Steel wire, 3)Galvanized iron, 4)Copper, 5)Lead, 6)Zinc, 7)Brass, 8)Aluminium, 9)Ceramic, 10)Pottery, 11)Tiles, 12)Bricks(Adobes), 13)Glazed China, 14)Glass, 15)Plastic, 16)Fertilizer sack, 17)Rubber, 18)Chemical, 19)Paint, 20)Liquid effluent, 21)Farm effluent, 22)Cattle manure, 23)Domestic effluent, 24)Bulk industrial waste, 25)Metal mine tailing, 26)Coal tailing, 27)China clay tailing, 28)Slag(furnace waste), 29)Agro-chemicals, 30)Fertilizer, 31)Lime	
	REF.1: Rock Classification Scheme Igneous rock, Dolerite, Lamprophyre, Pegmatite(granite), Aplite, Quartz porphyry, Felsite, Granite, Granodiorite, Diorite, Rhyolite, Andesite, Dacite, Basalt, Gabbro, Mafic rock, Ultrabasic rock, Amphibolite, Pyroxenite, Dunite, Peridotite, Serpentinite, Syenite, Carbonatite, Kimberlite, Agglomerate, Tuff, Ash(tephra) Sedimentary rock, Conglomerate, Sandstone, Arccisic sandstone, Felspathic arenite, Siltstone, Mudstone, Shale, Oil shale, Clay, Marl, Chalk, Limestone, Dolomite, Ironstone, Agate, Chert, Flint, Opium, Ashyrite, Coal, Carbonaceous mudstone, Caraceous mudstone, Laterite(Duricrust, Psolitic, Limonite) Metamorphic rock, Quartzite, Psammite, Pelite, Phyllite Pelite, Phyllite(Micaceous), Slate, Marble, Schist(Muscovite, Tectonic, Quartz, Hornblende-Epidote-Chlorite), Gneiss(Amphibole-Biotite-Muscovite-Granite/Cordierite/ Charnokitic/Sillimanite/Garnetiferous/Calc-silicate), Augengneiss, Granulite(Charnokitic, Pyroxine), Cataclastic, Mylonite, Migmatite REF.2: Mineral Abbreviations Apy-Arsenopyrite, Ba-Baryte, Bery-Beryl, Biot-Biotite, Bt-Bor-Bornite, Cal-Calcite, Cass-Cassiterite, Cp-Chalcopyrite, Cr-Chromite, Hg5-Cinnabar, Epi-Epidote, Feldspar-Fd, Flu-Fluorite, Ga-Galenite, Gt-Garnet, Hem-Hematite, Ilm-Ilmenite, K-Feldspar-Kfd, Mag-Magnetite, MoS-Molybdenite, Mon-Monazite, Py-Pyrite, Pyr-Pyrrhotite, Qtz-Quartz, Muscovite-Mus, AsS-Realgar, TiO-Rutile, Schee-Scheerite, Specularite-Sp, ZnS-Sphalerite, S8S-Stibnite, Tour-Tourmaline, Wolf-Wolframite, Zr-Zircon, Coal-Coal	
	H Photo: Whole site view Sampling site view	

Figure 1-8 Onsite description sheet (2014)

1-5. Field equipment preparation

Staff should ensure that counterparts and assistants are fully equipped every working day in the field. Each sampling team should have following items:

1. ID passes or passport copy
2. First aid kit containing: plasters, triangular bandages, antiseptic wipes, eye pads, two standard bandages and eye wash solution
3. Whistle or cow-bell to eliminate animal attack
4. Water-proof jacket
5. Sample transport rucksack
6. Sieve set (stainless steel sieve with 0.5 mm=500 µm mesh, with top lid and bottom collecting pan), and rubber coated cotton gloves, sweeping brush (hard plastic brush)
7. Trenching tool (large and handy shovel)
8. Medium thick plastic bags (20 x 40 cm, approx. A4, 0.1mm thickness) for sediment samples
9. Large thick plastic bags (60 x 70cm, approx. A1) to keep daily samples to be collected, and to sample semi-dry sediment (to be sieved in field base after drying)
10. Twisting vinyl tie (single wire) to bind the sample bag
11. Digital portable scale (< 2 kg, unit: g) to weigh collected sample
12. Black marker pen, multi-colored biro, clip folder and water-proof field note (to tag sample number to sample bag inside)

Map filling box for team leader and counterpart with small rucksack, containing:

13. Torch and spare recharged batteries (AA for GPS and AAA for torch)
14. 1 kg geological hammer, and sunglasses and cap
15. Hand lens (loupe)
16. Compass or Clinometer
17. Pen magnet (to identify magnetic particles of the sediment)
18. GPS (e.g. Garmin GPS 62sc) downloaded sites and access route data, mobile phone and satellite phone (for the case of normal mobile phone signal is not available, e.g. Thuraya-XT)
19. Field map (topography and geology) with sites and accessible routes marked stored in box file
20. Field description cards set with clip folder and mobile phone numbers kept in plastic bag
21. Multi-colored biro (ball point pen) and black marker pen spares sealed in plastic bag (in rucksack)
22. Spare copies of access permission letter in case needed by the general public
23. Digital camera and its spare battery
23. Enough money for fuel filling and daily food stuff (bottled water and ration)

Sampling team should check certain equipment on a turn basis, a job usually done in a day off in field base. Tasks include:

- checking, cleaning and reassembling sieve sets

- checking state of first aid kit, torch, whistle-cow bell, spare pens and informing staff where these items are not complete or operational
- preparing sufficient sample bags and printing sufficient field description sheets for the forthcoming period, including spares.



Item-14 geological hammer and hand lens



Item-16 Compass



Item-23 Digital compact camera



Item-18 GPS (Garmin 62SC)



Item-20 Clip folder, biro and marker pen



Item-6 Stainless sieve set



Item-12 water-proof field note



Item-13 Rechargeable batteries (AA/AAA)

1-6. Working with stakeholders, farmers and local peoples

The geochemical fieldwork depends on good cooperation with stakeholders, landowners, farmers and the public. Sampling teams need to be aware of important issues that may lead to potential problems in the field and at all times must remain polite, courteous and respectful. Team leaders need to monitor carefully the behavior of sampling team in the field and any incidents that breach a respectful code of conduct or cause upset to local landowners or farmers must be dealt with firmly and swiftly. Security passes (ID pass / passport copy) must be shown when requested.

Strategies to reduce the risk of such incidents should include the following:

1. Pre-fieldwork planning.

Site access planning is described in Chapter-2 and it is important to establish who is responsible for ownership or custodianship of areas to be sampled. This may involve some pre-fieldwork reconnaissance to the area and meeting with different individuals (TA: traditional authorities as tribe leaders of respective region, local committee, the district director etc.) / organizations (department of forestry as organizer of national forest reserves, district police office etc.) involved. The pre-fieldwork planning should identify:

- Military areas
- Forest Reserves / National Parks / Wildlife Reserves
- Mining areas
- Large country estates
- Natural and man-made hazards

Permission to work in these areas should be obtained before fieldwork commences.

2. Access.

Standard geochemical survey access procedures are described in Chapter-2 and gaining access to collect a sample is a significant issue that has to be dealt with when sampling. There are regional differences and access can be more problematical in some areas than others. International border area with Tanzania, Zambia and Mozambique, for example, does not have a sufficient network of public footpaths and access in more problematical- samplers need to keep as close to public access roads as the demands of the survey require and avoid roaming across country where tracks provide alternative access. There may be cases where the letters have not been received and samplers should carry tidy, clean copies of the letter to deliver in person. Where occupiers still object to the samplers' presence they should leave immediately with good grace, and find an alternative site.

3. Informing to the local community.

Effort should be made to inform local communities prior to our activities. This can be done by contacting the local branch of some farmers union or the community chief.

4. High visibility and low profile.

High visibility of vehicle route choice of sampling teams is important for a safety measure especially. Because sampling teams are on official business and reassure landowners that we are not suspicious characters clandestinely moving around the countryside. Although maintaining a high visibility sampling teams should not behave in a way that unnecessarily draws attention to themselves. Public roads and footpaths should be used wherever possible and vehicles should be parked in public rather than private areas.

2. Field campaign

2-1. Access planning

1. In order to gain safe access route to the field, practical access check is done especially availabilities of the crossing access routes of the principal river and the peripheral loop routes of the basin prior to daily sampling site planning. Because the latest Google earth satellite imageries does not express generally the detail of hazardous flood records in rural area of the last rainy season (road collapse and broken bridge etc.) due to updating span, footpath availability due to the accuracy of imagery pixels or vegetation coverage (Figure 2-1).
2. The general estates and forest reserves are identified on the 1:50,000 planning map and the addresses of landowner or land agent are obtained from district officer / counterpart / assistants.
3. Daily sampling sites, as well as sampling course and order, are planned by team leader, taking into account to suitability for daily working time (a set of access / sampling / starting and finishing time). Normally, 6 sites / team / day were average of 2014 field campaign, but depending largely on vehicle accessibility and weather conditions. It needs to keep our flexible decision on sampling plan for unexpected road condition (select second alternative), for abrupt weather change such as squall (waiting - parking at safe place) and for a case of incidents as shown in Table 1-3.
4. Daily access planning of every team, particularly access route and sites, is aware of other teams before starting time. Additionally it need to keep communications each other in promised time (e.g. 15:00 = one hour before return time) for better security improvement in case of alert such as vehicle break down / stuck trouble or route missing.
5. Working area of sampling teams is divided definitely (i.e. catchment divide line or well-known route) to avoid duplication of sampling.

Photograph-7: River crossing access in GC06



Photograph-8: Wooden bridge checking in GC07



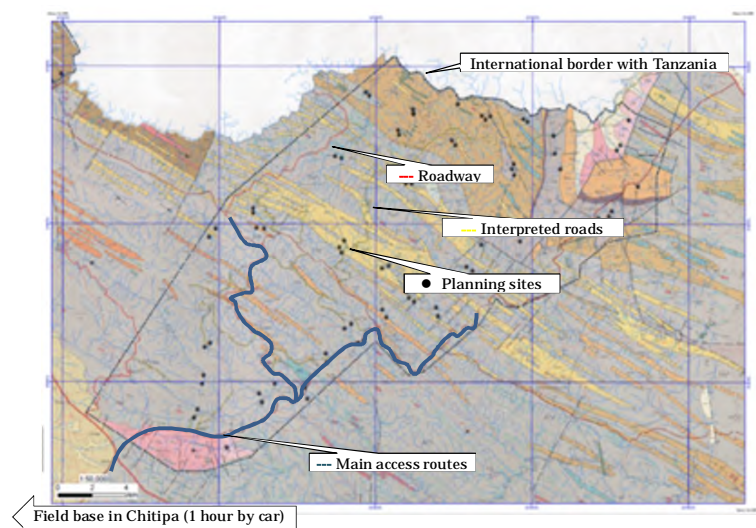

Figure 2-1 Planning map of interpreted access route and sites with geology (GC02, 2014)

2-2. Field demonstration

Counterpart (C/P) and assistant workers must be given adequate training in all aspects of geochemical sample collection before being asked to collect routine samples. Training is formally undertaken on the day after the field group has assembled, so no other activities should be scheduled for that day. It is advisable to identify suitable training and have the landowner's permission in advance of the training exercise.

1. Stream Sediment Sampling: The entire site procedure for collection of a stream sediment sample should be demonstrated and explained by members of JICA team staff or well-trained GSD staff. This should include completion of a field description sheet including all site observations. New comers should then split into pairs and repeat the collection process, under staff's supervision. In general, 2 - 3 hours should be allocated for this stage of training.

2. Field description sheets - familiarization and data recording: New C/P must be familiar with the layout and understand the protocol involved in completing a field description sheet. Staff should ensure that each member of the field team is highly trained as is necessary to make them fully competent with respect to field description sheets. C/P must be made familiar with GPS usage and in the use of a compass-clinometer to identify major structural property of regional geology.

3. Supervision: C/P should be carefully supervised in the field by members of staff and experienced

members during the first few days of the sampling programme. Guidance on dealing with access negotiations might be shared in the team. It is important that all members understands why they are actually collecting the samples and the geochemical survey rationale. Each C/P should receive a copy of this manual at the commencement of their work. Where possible, staff should make every attempt to explain land access arrangements to C/P on a day-to-day basis. This should include marking relevant information on field maps.

4. Behavior in public: Sampling team must be polite and courteous when dealing with members of the public. A general knowledge of field 'etiquette' is required and the country code must be adhered to at all times. It is important that the JICA team and GSD staff maintains a good public image and is not misrepresented by poorly informed members.

5. First aid kits: JICA team and GSD staffs have a responsibility to ensure the reasonable safety of all members at all times. The risk assessment and field register for all field procedures must have been completed by the project manager prior to commencement of fieldwork (see Chapter 1). Composition of the first aid and safety kits must be explained to all team members. These kits must remain in the field rucksacks at all times. If the first aid kit has been used, they should inform team leaders so the kit can be restocked. Sampling team should carry a whistle-cowbell, a torch and a survival bag in the field rucksacks and these should be checked each day before sampling commences.

6. General cautions:

- Sampling must always be undertaken in pairs. It is important to stress the necessity for sampling pairs to remain together at all times during the day.
- At all times it must wear long sleeve shirts and cap/hat - gloves set and be advised when offered the job of the requirement for strong boots and waterproofs. The use of trainers or trekking sandals for fieldwork is unacceptable.
- All members should carry their official identification pass at all times in case of difficulties with landowners or the public. The mobile phone contact numbers must also be carried by samplers so that emergency contact can be made when necessary.

Photograph-9: Field demonstration in GC08



Photograph-11: Polite notice to local community



Photograph-10: First aid kits



Photograph-12: Permission by local committee



2-3. Daily field campaign procedure

Preparation for fieldwork is described in Chapter 1 where site planning and access were discussed. As part of the daily routine in the field the team leader, C/P and assistant should carry out the following procedures:

1. The number of drainage sediment samples to be collected per day and on the terrain. Now drainage samples are required, 6 drainage sites per pair make an average day. The distance to be covered and weight of load has to be considered.
2. It is good practice to have all sampling days for any particular field-base planned in detail in advance. This is done by sorting the sites into convenient and sensible groups: topographical relief, roads, footpath, major rivers and suitable bridging points should be taken into account. Planning at this stage must be done in detail in order to facilitate smooth day-to-day operation of the field programme.
3. Most geochemical field work is carried out in the dry season and the procedure in this manual are mainly focused on the field campaign during the dry season. When rain season sampling should need to be done, length of day and more adverse weather become prior considerations.

4. Field maps should be prepared one day in advance of the sampling in order to allow C/P to familiarize themselves with the area and to transfer relevant geological data. Any access information should also be clearly marked on the field maps. All field maps are 1:50,000-1:100,000 sheets for regional sampling.

5. The C/P field maps are prepared by transcribing planned sample sites from the original planning map onto a separate 1:50,000 map. This has to be done in a logical order to ensure that the C/P has a reasonable route (e.g. bridges to cross rivers, no major roads to cross etc...). When a day has been planned onto the map, any access details have to be plotted onto the map. The maps are then placed into an A4 box file, this is then placed into a large self-seal bag, along with the following equipment:

- Compass(Clinometer)
- GPS
- Black marker pen
- Multi-coloured biro (ball-point pen) or red/blue biro
- Clip folder with relevant number of field description cards
- Hand lens (loupe)

The map sets are then assigned to a pair of teams. Different pairs are formed for each survey region, which is to make sure that sampling bias is not introduced by a particular pair of samplers getting into non-standard habits.

6. The assistants are expected to pack their rucksacks the night before. For every stream sediment site this rucksack is needed, which contains a sediment sample bags, twisting vinyl tie, and a sufficient spare.
7. Each sampling pair should check that they are carrying a spare multi-coloured biro and black marker pen and field note.
8. Spare or larger sample bags are required in case wet or semi-dry sediments before sieving have to be collected.
9. Sampling teams should communicate by mobile phone on a daily basis. Phones, as well as GPS navigator and digital compact cameras, must be recharged every night to ensure that their batteries will not run out during the day.
10. Site numbering: The sample site number is comprised of two parts; the first two digits and the rest. The former indicates the site alphabetic area code and team leader's initial: BS-1 means the first sample taken in Area-B (GC02) by Mr. Suzuki. The latter gives the sampling order. Any labelling or

numbering errors which can be identified should be rectified immediately. The numbers are also transcribed to the plastic paper tags into packed sample to analyze, and then are submitted to the laboratory along with the samples, so corrections must be made before the samples are dispatched to the laboratory.

Photograph-13 Access to sampling site along the river sand floor on foot



2-4. Collecting drainage sediment samples

Before proceeding with the collection of a stream sediment sample, hands must be clean, rinsed in stream water or bottled water and free from jewelry, plasters or any hand creams or lotions, otherwise wear field gloves.

1. Sampling tool management.

Following collection of any wet samples wash the trenching tool, sieve nest with stream water. The sieve set comprises one stainless steel frames (approximately 20 x 6 cm), housing 500 μm (30 meshes) aperture stainless steel sieve with exclusive top lid and bottom tray (JIS: Japanese Industrial Standard). The sieve nest should be assembled in a set in a stable position of rucksack, as close to the sediment collection point as possible. The collection sieves must be clean and free from any particulate matter prior to commencement of sampling.

2. Site selection and pre-sampling procedures.

The sediment collection position should be an active area of the stream bed, and should ideally be centrally placed in the stream, to minimise contamination from any bank slip material. But practically dry or wet sediments with small stream of point bar or river floor, in dry season, might be sampled in Malawi. Pre-sampling procedure is as follows;

- Remove the uppermost (10 - 20 cm) heavily oxidized sediments using the trenching tool (hand shovel).

- Load the sieve with coarsely sorted sediment from beneath the oxidized layer, taking care to remove any large clasts before placing the material into the sieve.

3. Sieving.

After loading proceeds, it rubs the stream sediment through the sieve assembled with top lid and bottom collecting pan, providing sufficient <2,000 μm material (sands) to produce adequate volume of less than 500 μm materials (approx. 600 g) in the bottom pan. During this process look out for any contaminant material (fragments of leaves and burnt twigs etc.) in the sediment, which should be removed from the sieve and the details noted on the field description sheet.

Photograph-14 Loading sediments into stainless steel sieve set

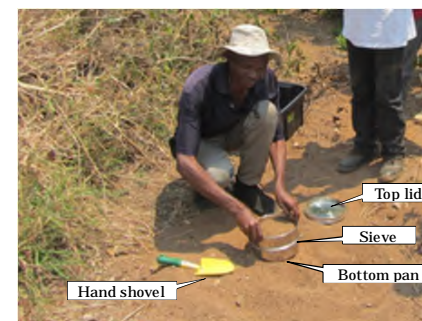

Before the sieve becomes too full and heavy it should be removed and shaken to allow more <2,000 μm material to fall through into the bottom pan. The sieve material can then be discarded and this material is often worth observing for stream clast lithologies, which are noted on the field description sheet. Several cycles of filling, rubbing, shaking and discarding of the sieve material may be required to provide enough material in the bottom collecting pan (approx. 600 g).

Photograph-15 Shaking the sieve to collect the sample



When the sieve material has been well mixed and rubbed through, clean the gloves and then use the brush to sweep any particulate material off of the top rim and outer sides of the sieve. The sieve should then be picked up carefully, without disturbing the collecting pan, and gently shaken to allow additional <math><500\ \mu\text{m}</math> material to fall through into the collecting pan. If there appears to be insufficient material in the collecting pan, after weighing the collected sediment sample by digital scale, another collecting cycle should be done to cover complement. Once there is enough sediment in the collecting pan, remove the sieve and retain the <math><500\ \mu\text{m}</math> material which it contains.

Collected sediment samples are put into the sample plastic bag (20 x 40 cm), along with site number tag of waterproof plastic paper, and then tie up it with twisting vinyl tie and site numbering by black marker pen onto the bag.

Photograph-16 Collected sediment sample into plastic bag

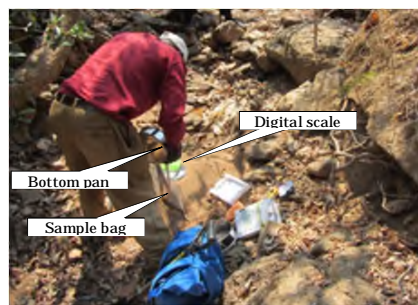

Photograph-17 Transcribing the site number onto sample bag by black marker pen



4. Sampling a dry/semi-dry/wet drainage site

In field campaign in dry season, collected samples are ordinarily dry and soft sandy state, as shown in Photograph-15 and 17, excepting the planned sites in the marsh/swamp area covered by reeds (wet muddy/dry-harden state), over 4th order stream (low-moderate flow, wet sandy state), and upper

straight stream of forest covered valley (low-moderate flow, wet sandy state).

- 1) If a site is dry (ordinary soft sandy state), a 'dry sieved sample' should be collected. Select the site in the usual manner and set up the sieve set. After removal of the surface sediment layer, sieve enough of the <math><500\ \mu\text{m}</math> dry sediment to fill over 600g sample in medium plastic bag. Number the bags with the appropriate sample number, and also fill out the sample tag then put it into the bag.
- 2) If a site is wet (or too little water is present to allow the normal stream-sediment sampling procedure to be carried out, or semi-dried state just after unexpected squall), but not grassed over, a 'wet sample' should be collected with 2 or more medium plastic bags. This amount of wet sample is needed to obtain over 600g of sieved material at the field base, according to the estimate of the portion of coarse sediment. Mark the sample number on the map and fill in the field description sheet as normal. Collected wet samples should be dry sieved after drying at the field base (accommodation).
- 3) When a site is wet in the stream with low to moderate flow, a normal 'wet sieved sample' should be collected over 600g, note the site on map, numbering the bag, and described as usual. Then collected wet sieved samples should be dry and packed again with medium plastic bag at the field base.

5. After-sampling

After whole sampling procedure, clean the sieves as well as possible with hard plastic brush at site and then wash before use at the next stream site. If a convenient site for washing equipment is passed between sites, this should be used in case the next site is also a 'dry site'. Wet sieved and wet samples should be stored carefully; the sample number written on the surface of wet and heavy plastic bag can be easily erased unless the drying process in field base is completed.

Photograph-18 Dry sieved / semi-dry / wet sieved sampling



2-5 Field description

Following the field description sheet (Figure 2-2), during sampling processes by assistant, all columns should be filled by C/P and team leader completely as follows;

Photograph-19 Field description at sampling site



A: Sample site information

Survey area (alphabetical capital letter, e.g. B), site number (e.g. BS-1), collector name (e.g. Suzuki) and sampling date & time are written for basic information first. Though the sampling date and time are restored from backup memories of the GPS and digital picture records, the hardcopy of the description sheet data is the primary source of information.

B: Positioning data

After sampling point decision, a GPS entered positioning data is transcribed onto description sheet (UTM, WGS-1984 normally) by Easting-Northing and Elevation in metric unit. Then using coordinates from a GPS, mark a short line perpendicular to the stream flow as the symbol of the exact site location together with the site number in red-blue biro on the field map.

C: Drift and drainage type

Choose the drift type from multiple choices in the column, one or two through sediment identification, the drainage types as well. Drainage types column are consisted of two categories of the types (dry, wet, seepage, ditch, drain) and drainage width (small stream, stream, small river and river), so only one option can be chosen for each category. Among drainage-sediment conditions multiple choices it might be checked the actual state of the drainage at sampling occasion. If it is possible to get the river name provided by local people, this will be good chance to communicate each other. Drainage order is identified by planning map, then other observations and hearing details of locality are described in the last column.

D: Land use and vegetation

One or several choices should be selected the land use types from multiple choices in the column, due to observable features around the site. Usually arable type is variable in one site, and rough grazing is widespread through the country.

E: Clast state

Select one choice in respective item, such as clast precipitation colour, abundance, sediment colour and clay-organics abundance. These choices are not so variable in collected sample, except grass-covered or clayey dried marsh (black-coloured and high organics).

F: Geology and mineralization

Describe the catchment geology (lithological variations), not in abbreviation but in geological terms, expressed in a published geologic map (1:50,000) with the attached legend. Also write down the site geology observed around the sampling site (mainly lithological variation and visible mineral composition by hand-lens observation with general structural data such as dip and strike of gneissosity, shear zone or strata, weathering state etc.). If there is no outcropped around site, it better

to note the geological information by clast lithological variation. Also note the clast composition by descending order, which is very important to understand-interpret the chemical composition to be analyzed (e.g. heavy mineral contents [magnetite-rutile-garnet etc.] or laterite fragment concentration).

Describe the mineralization occurrence with its style, commodity, abundance and associated alteration in outcrops, and also note the probability of some geochemical anomalies to be established by geochemical mapping, such as copper oxide-sulphide occurrences with quartz veins, garnetiferous pegmatite vein, skarnized vein or block with argillization, stained ferromanganese crust in lateritic soil or terrace sediments, and magnetic rocks etc. (by hand-lens, magnet pen or magnetic susceptibility meter etc.). The descriptions here might fully explain the geochemical anomaly as well as the clast lithological composition.

To describe geological information, it is helpful to use the technical terms given in REF.1: Rock classification scheme and REF.2-mineral abbreviations.

G: Possible contamination,

Select possible contamination items from the given options to comprehend the man-made influence upon the sediment chemical composition. But the chemical analysis data may not be influenced so much in rural area because the contaminants can probably be washed or flushed away by sufficient water supply in anticipate pluvial season.

H: photo

In the last column, note the image numbers of digital photographs, which will sequentially keep the time record of sample sites as well as GPS. Photographic records can help correct description errors and also work as “secondary observation” for the interpretation of the chemical analysis results.

Description Card of Drainage Geochemical Survey (2014) ver. 1.3(2)	
A	Survey Area: 14GC01, 14GC02, 14GC03, 14GC04, 14GC05 Site No.: ET51 Weather Condition: Clear, Cloudy , Rainy, (Stormy) Collector: TAJIHL Date & Time: 21-Oct-20(11:30)
B	UTM-easting: 564495 (GPS reading, ARC1950) UTM-northing: 8689055 (GPS reading, ARC1950) Elevation: 1280 m (GPS reading) Planned UTM-E: Planned UTM-N: UTM-E: UTM-N:
C	Drift types: 1)Alluvium, 2)Coarse Gravel, 3)Silt, 4)Marsh, 5)Clay, 6)Scree(Talus), 7)Mud Gravel Drainage types: 1)Ditch, 2)Wet, 3)Seepage, 4)Ditch(Waterway), 5)Drains, 6)Small stream<3m], 7)Stream<10m], 8)Small river[10-30m], 9)River[30m-] Drainage-Sediment conditions: 1)Dry-sand/gravel bar, 2)Pond with dry sections, 3)Low flow, 4)Moderate flow, 5)Strong flow, 6)Channel filled bank to bank, 7)Overflow-bank burst, 8)Spate/Flood River name: 1) Drainage Order: 1(2,3,4) Additional Comments on Locality: just after waterfall
D	Land use: 1)Coniferous Forest, 2)Deciduous Forest, 3) Sparse forest in burned-off field, 4)Small Pit-Pan Mining, 5)Quarrying, 6)Gravel Pit, 7)Rice Paddy, 8)Agriculture, 9)Grazing, 10)Abandoned Tobacco, Cassava, Cotton, Millet, Sorghum, Groundnuts, Coffee, Tea, 11)Pasture, 12)Heather, 13)Forest or Wildlife Reserve, 14)Industrial/Type: 1)
E	Clast Precipitates Colour: 1)Orange, 2)Brown, 3)Black, Clast Precipitates Abundance: 1)Low, 2)Moderate, 3)Heavy Sediment Colour: 1)White, 2)Grey, 3)Light Brown-Orange, 4)Dark Brown-Black Sediment Composition: Clay [1]Low clay, 2[Moderate] clay, 3[High clay], Organics [1]Low organics, 2[Moderate] organics, 3[High organics]
F	Catchment Geology Description(from published geological map): Site Geology(within 100m of site) Description: Outcrops(within 100m of site): 1]None, 2]Minor, 3]Moderate, 4]Abundant Clast Lithologic Composition(descending abundance): Mineralization style in bedrock: 1)None, 2)Vein, 3)Fault, 4)Lens, 5)Stratiform, 6)Joint or Fracture, 7)Disseminated, 8)Staining or Coating Mineral Occurrences: 1)None, 2)Others: 1, 3)Sulphides, 4)Others: 1 Mineral Abundances: 1)None, 2)Rare, 3)Common, 4)Frequent, Associated Alteration: 1
G	Possible Site Contamination: 1)Manufactured Metal, 2)Non-Steel wire, 3)Galvanized iron, 4)Copper, 5)Lead, 6)Zinc, 7)Brass, 8)Aluminum, 9)Ceramic, 10)Pottery, 11)Tiles, 12)Bricks(Adobe), 13)Glazed China, 14)Glass, 15)Plastic, 16)Fertilizer sack, 17)Rubber, 18)Chemical, 19)Paint, 20)Liquid effluent, 21)Farm effluent, 22)Coal slag, 23)Domestic effluent, 24)Bulk industrial waste, 25)Metal mine tailing, 26)Coal tailing, 27)China clay tailing, 28)Slag/fluore waste, 29)Agro-chemicals, 30)Fertilizer, 31)Lime
REF 1: Rock Classification Scheme Igneous rock, Dolomite, Lamprophyre, Pegmatite(garnite), Aegite, Quartz porphyry, Pelite, Granite, Granodiorite, Diorite, Rhodite, Andesite, Dacite, Basalt, Gabbro, Mafic rock, Ultrabasic rock, Amphibolite, Pyroxenite, Basalt, Peridotite, Serpentinite, Syenite, Calc-silicate, Kimberlite, Agglomerate, Tuff, Ash(tephra) Sedimentary rock, Conglomerate, Sandstone, Arcosic sandstone, Foliated arenite, Siltstone, Mudstone, Shale, Oil shale, Clay, Marl, Chalk, Limestone, Dolomite, Ironstone, Agate, Chert, Flint, Gypsum, Anhydrite, Coal, Carbonaceous mudstone, Carbonaceous mudstone, Laterite/Duricrust, Psiltite, Limonite Metamorphic rock, Quartzite, Psammite, Pelite, Phyllite, Pelite, Phyllite(Micaceous), Slate, Marble, Schist(Muscovite, Tectonic), Quartz, Hornblende-Epidote-Chlorite, Garnet/Amphibole/Biotite/Muscovite/Garnet/Coelander, Charnokite/Sillimanite/Garnet/Orthopyroxene/Calc-silicate), Aspidomete, Garnet/Charnokite, Pyroxene, Canalicite, Mylonite, Migmatite REF 2: Mineral Abbreviations Apy-Arsenopyrite, Ba-Baryte, Bery-Beryl, Bix-Bixenite, Cal-Calcite, Cas-Cassiterite, Cp-Chalcopyrite, Cr-Chromite, Hg-Cinnabar, Ipi-Igite, Pld-Pyrolite, Pldg-Pld, Plu-Plumbite, Plu-Calcium, Cr-Carnallite, Hm-Hornblende, Hn-Hornblende, K-Feldspar-Kf, Mg-Magnetite, Msd-Muscovite, Mm-Muscovite, Py-Pyrite, Ppy-Pyrolite, Qz-Quartz, Muscovite-Mus, AsS-Rutile, TiOx-Rutile, Sch-Scheelite, Sp-Sphalerite, Zns-Sphalerite, Sns-Sillimanite, Tour-Tourmaline, Wolf-Wollastonite, Zr-Zircon, Coal-Coal	
H	Photo: Whole site view ✓ Sampling site view ✓

Figure 2-2 An example of filled description sheet (GC05, ET57)

Photograph-20: Sampling site described in Figure 2-2 (GC05, ET57)



5. After-description

Before leaving the site, as was performed on arrival, thoroughly rinse or clean all equipment to remove traces of particulate material to avoid contamination between sites. Also, check the field description sheet to ensure that all observations have been noted. If any field observations are not applicable at a site, e.g. there is no contamination, score through the relevant box so it is clear that the observation was investigated. Finally, on departure, check whether all of the samples and field equipment have been packed in the rucksacks to be taken to the next site.

2-6. Management of unexpected field condition

1. On daily scheduling, if team leaders can forecast when the weather change worse (rain or squall), they should estimate its direct and subsequent influences to the field activities and discuss the alternative option to optimize the daily schedule, such as field base works of sample drying or quartering operation, holiday, waiting until the weather and access condition improves.
2. On planned access route, if the team encounters hostile road conditions (e.g. marsh / vulnerable wooden bridge / narrow path on alluvial fan / mountainous steep-slippery or rocky route / wet or low flow river crossing part etc.), they should review the accessibility to the planned sites considering the schedule of the day and possible case that the vehicle should get stuck. And at all time need to define the secondary way to reorganize the schedule and planned sites visiting, after well hearing the opinions of experienced team members and local people.
3. When travelling on foot, if the team gets into trouble (having a problem with local people, encountering dangerous animal or plants attacking team members, some member having sign of infection or illness including heat stroke and tiredness, injury by stumbling or slipping, flexible measures should be taken (e.g. return to field base and go to hospital directly etc.) for better approach on the other day.

2-7. Field sample checking, collation and storage

Samples collected in the field by survey teams must be checked off on a daily or weekly basis, and then double-checked before dispatching to chemical analysis laboratory.

1. Daily checking

On return from the field, each sampling team should put their samples into one large plastic bag to store temporarily in field base, check the daily sample numbers and wet samples. Samples should not be laid out on dusty or graveled ground where plastic sample bags may become contaminated - put them into a clean large plastic bag and then in container box.

2. Checking at drying procedure

At the timing of samples to dry, plastic bags of wet sieved samples and wet samples should be picked up from temporarily storing container box, then it should be laid out and spread on clear plastic sheets (opened large plastic bags) in the place not to get in the way of other parties in field base (usually, concrete lining of parking side patio or septic tank, after getting permission from the lodge owner or receptionists). In the drying process, the numbered tag and plastic bags are separated from the sample for several hours in the open air. So you will need to attend them the process the right pairs (miss-matching is fatal for all procedure) to keep the sample consistency. Be careful of strong wind, and also persons and animals that may be curious and try to trespass. Unclear or erased numbers on plastic bags should be marked again by black marker pen after collating the sample tag inside. Wet samples should be sieved at dry condition to obtain more than 600g, and restored in a numbered plastic bag with tag again as before.

3. Checking after sample quartering procedure

After sample quartering process to prepare samples to analyze in laboratory, you should transcribe and check the numbers assigned to the samples, collating the numbers on the sample tags with those on plastic bags. Each sampling team should deal with the samples themselves, and the team leader should check off their samples and watch the members' activities during the quartering process to avoid wrong numbering due to inexperience. There become two series of samples; one is the samples for shipping to laboratory (120-180g, respectively), the other is kept and stored in GSD (around 500g). Finally the collation of every series of samples in one survey area should be done by optical and photographic records. When checking off has been completed, samples should immediately be put away in appropriate storage containers (Box for Samples to analyze, the other Box for remain samples to store in GSD), and labeled these contents, respectively.

4. Double checking

On completion of each batch of a hundred samples, every sample number should be double checked before dispatch to the laboratories. It is most efficient to have two persons work for this task, and one of them should be the team leader. The samples should be checked into storage containers in numerical order for return to laboratory, in order to minimise errors on dispatch and receipt. Each sample should be identified and checked off on the sample-number list (use the field data base sheet). Also if you find any sample bag swollen by expanded air, drain the air as much as possible, from zippered part to avoid a burst the plastic bag and subsequent contamination in the box during transport. For the regularity of republic of Malawi, exporting permission of sediment samples should be obtained, of course, via GSD before shipping to laboratory in South Africa.

5. Sample storage

The daily collected samples should be stored in the team leader's room until the drying and

quartering process. After field campaign of respective survey area (11 areas; GC01 to GC11), sample batches of each survey area (sample to analyze and remained sample) should be store temporarily in GSD Lilongwe office (for shipping procedure), and GSD Zomba headquarter office (for hand held XRF re-testing), respectively.

Photograph 21: Samples are checked in after each day of sampling in field base (Chitipa)



Photograph 22: Samples are laid out to dry in field base (Lodge in Mzimba)



Photograph 23: Samples stored in box after check to dispatch to laboratory (GSD-Lilongwe)



2-8. Field database

Field data is recorded in a Microsoft Excel 2000 spread sheets in order to treat it in subsequent geochemical mapping by ArcGIS 10.2.2 and to integrate all obtained field data just after field campaign as soon. All relevant data, hand written, from the original field description sheets are transcribed by themselves to column A to H of Excel spread sheets. Each set of data should then be arranged in numerical ascending order; from lowest to highest sample number.

The layout of the spreadsheet is designed to be quite similar to that of the field description sheet, facilitating the data entry (Table 2-1). Site number, site location data (Coordinates in UTM and elevation in meter) and sampling date / time are carefully imported from Garmin GPS apparatus via Garmin Map Source or Garmin Base Camp of UTM-WGS1984 format-Southern hemisphere 36S.

Table 2-1 An example of field database sheet (part)

Table with 4 main columns: A (Site identification Data), B (Visit date), C (Current No./last WGS-84), and D (Drainage-Analysis Data). The table contains numerous rows of data, including site numbers (e.g., T 14208), dates, coordinates (UTM E, UTM N), drainage types, and various descriptive comments for each sampling event.

3. Analytical sample preparation

3-1. Sample drying and sieving

The sample drying and sieving processes, which is applied to semidried-wet samples and wet sieved samples, in field campaign are periodically carried out in field base of each survey area. Depending on the sample volume and material composition the time duration of drying varies, but drying method by natural wind and solar heat is much better and convenient than by electric drier-heater etc. in ordinary field base condition.



Figure 3-1 Sample drying and sieving in field base (Mzimba)

Cut and open a large plastic bag to make a sheet for spreading the wet samples on (Figure 3-1), turning over wet samples and picking up and away large clasts and plant fragments occasionally for their rapid operation. A few contaminations by these processes of turning over or blowing dusts are not avoidable even in their most careful handling, but might be permitted.

After drying samples, dry sieving should be done to obtain dried 600 g samples as is usually done for wet samples, while wet sieved samples could be back without sieving operation to their original medium plastic bag.

3-2. Sample splitting by conical quartering

The objective of sample splitting is to obtain a proper quantity of analysis (120 g in this case) that is representative of the average properties of the whole sample. Splitting is usually realized by using riffle box or conical quartering operation.

Ordinary conical quartering process is illustrated in Figure 3-2, and explained as follows;

Coning and quartering (Conical quartering): This method of sample reduction involves shoveling the bulk sample to form a cone, the cone is turned over three times to mix thoroughly and then flattened on a hard clean surface or small canvas/plastic paper. The sample is then divided into four quarters and two of the diagonally opposite quarters discarded. Remove two opposite quarters and mix the two

remaining quarters together again. Repeat this process until a sample of the required weight is obtained, normally 2-3 cycles to be operated (TMH5, 1961).

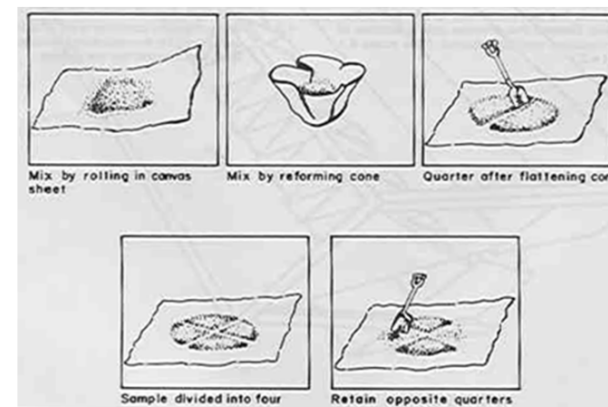

Figure 3-2 Conical quartering process (TMH5, 1961)

Through above mentioned procedure, the amount of samples (600-800 g) is halved (300-400 g) in one cycle so that performing two cycles should give the acceptable quantity (150-200 g), but the quantity can be still overweight and hard to adjust (required volume: 120-150 g) and even hard to be adjust. Therefore, the sample splitting procedure by conical quartering has been modified to be more practical and efficient in the field base situation using asymptotic approach as follows;

See Figure 3-3 and Figure 3-4. The sample of initial amount (600-800 g) is quartered in 1st cycle to give the amount of 150-200 g, which is called A. The discarded sample of 450-600 g is kept in the storage. A is quartered in 2nd cycle to give the amount of 38-50 g, which is called B and will part of the analytical sample. The remaining sample of 112-150 g is quartered in 3rd cycle to give the amount of 28-38 g, which is then added to B to make B2 that weigh 66-88g. Repeating the same process up to 5th cycle will provide the required quantity of sample (approximately 120 g) for analysis as shown in Figure 3-3 and 3-4.

To provide analytical samples you need a digital scale of 1 g precision, small zipper storage plastic bags and small hand shovel as shown in Figure 3-4.

Obtained analytical samples are packed in a small zippered plastic bag with sample number and numbered tag inside (Figure 3-4), and the other remained samples are packed again to original medium plastic bags to store in GSD-Zomba. These storage samples are available for other

investigation; e.g. hand-held XRF testing etc. shows the whole procedure of above mentioned practical conical quartering.

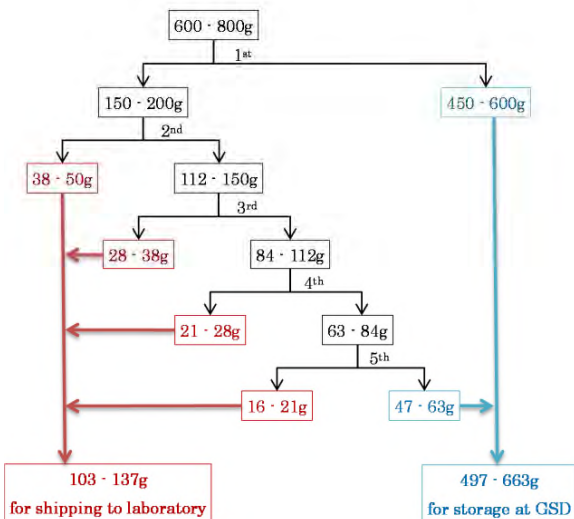

Figure 3-3 Practical splitting process by conical quartering of this survey

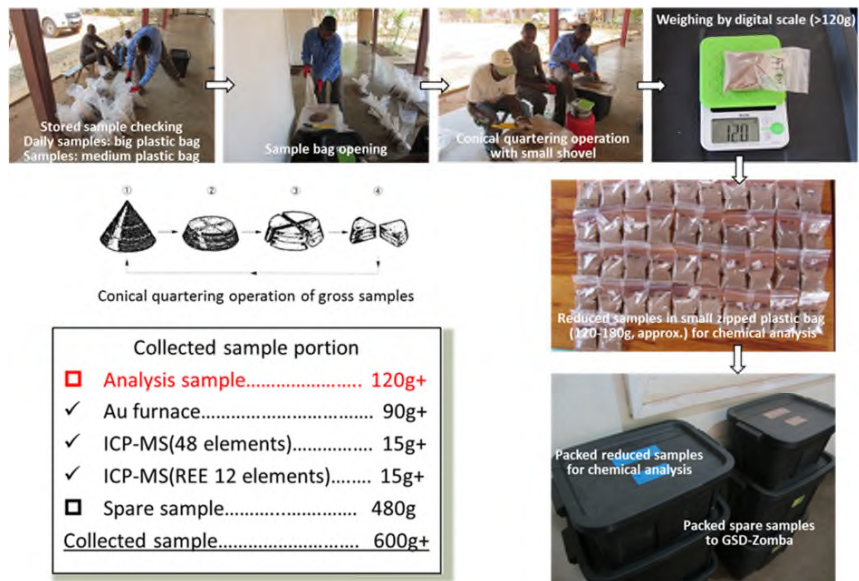
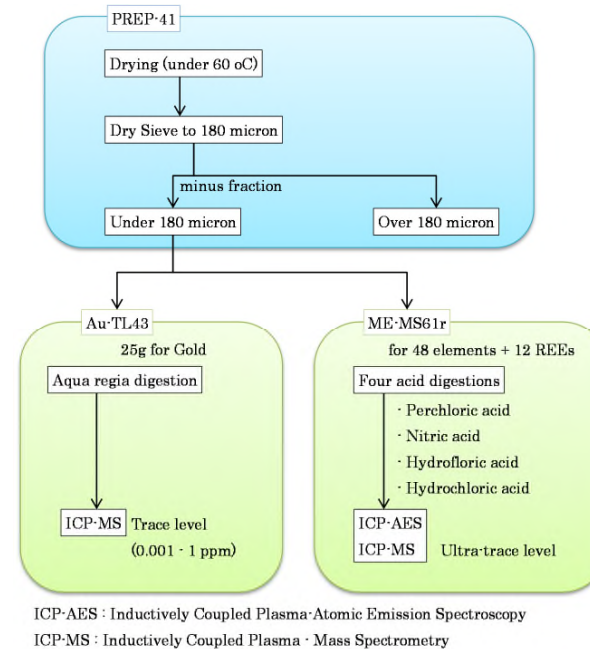

Figure 3-4 Practical splitting process by conical quartering of this survey



ICP-AES : Inductively Coupled Plasma Atomic Emission Spectroscopy
ICP-MS : Inductively Coupled Plasma Mass Spectrometry

Figure 3-5 Analytical procedure at laboratory (ALS Chemex South Africa)

3-3. Sample registration and packing

A list of sample numbers is provided in Excel spreadsheet as a copy of field database (Chapter-2, Table 3-1) and is attached to the samples shipped-dispatched to the laboratory. Later the list will be combined with chemical analysis results for the subsequent geochemical mapping.

Analytical samples (around 120 g, respectively) should be packed in sturdy plastic containers (approx. 30 kg per package) after fastening every 15 to 20 analytical samples with medium plastic bag and duct tape / gummed tape (to avoid sample contamination and keep numbering order). Analytical samples should be packed in numerical order for easily checking the samples at the laboratory reception. Every package of plastic container will be accompanied with a hardcopy of sample number list for invoice. And the same electronic file of the list will be e-mailed to the person in charge at the laboratory too.

Table 3-1 Sample number list to laboratory (e.g. 2015 dispatching)

Table with multiple columns containing alphanumeric codes such as FT01, FK01, GT01, G3101, MT01, etc., representing a list of sample numbers for laboratory dispatching.

- 25/52 -

Before dispatching the prepared samples to laboratory in foreign countries, you must submit the EXPORT PERMIT to the Ministry of Natural Resources, Energy and Mining (MNREM) via GSD officer (Figure 3-6). Attached with this original document, it allows sending the packages by commercial carrier (DHL etc.) based on the regulation of the Republic of Malawi.

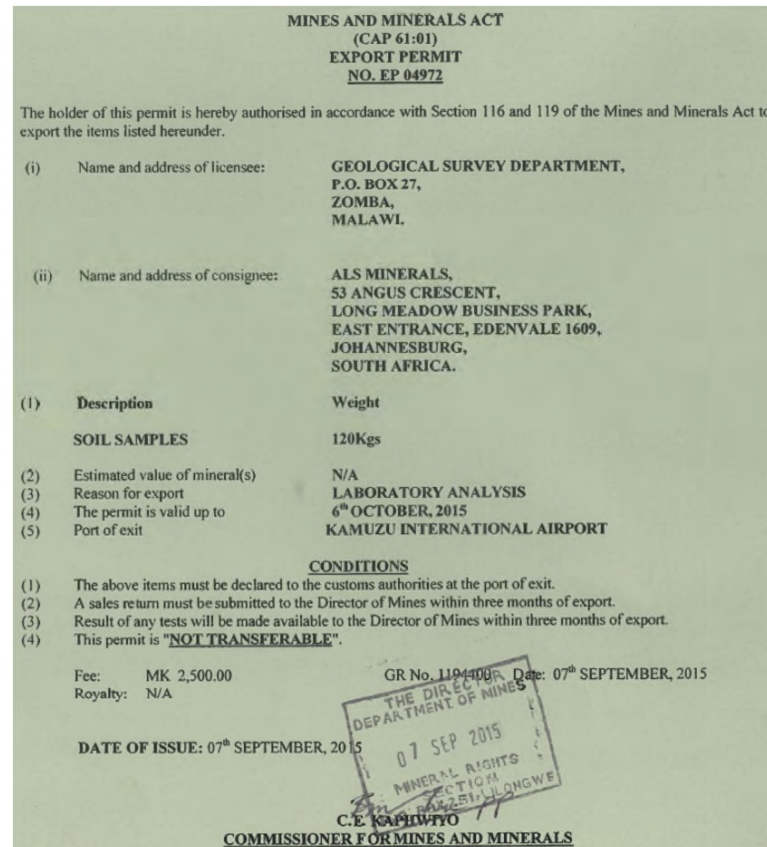

Figure 3-6 EXPORT PERMIT (e.g. 2015 dispatching)

3-4. Dispatching to laboratory

After all procedure as mentioned above, analytical samples are dispatched to the laboratory attached with their own sample submittal form with our work order detail (ALS, Figure 3-7). Then bring prepared packages to commercial carrier and dispatch to the laboratory (ALS, Johannesburg, South Africa) with commercial invoice (DHL, Figure 3-8).

Appendix 3-6

ALS Minerals Sample Submittal Form

Company Name: Sumiko Resources Exploration & Development Co., Ltd
 Submitted by: Ioki SUZUKI
 Telephone: +81-3-5405-2172
 Courier/Waybill: DHL/
 # Containers: _____
 Date Shipped: September 2015
 PO Number: _____

Internal Use Only
 Date Received: _____
 Client Code: _____
 Workorder No: _____
 Quote: _____
 Template: _____

Standard Project: Malawi 2015
 Commodity: Stream sediments (already sieved -500 micron, air dried) Ore Trace
 Special Instructions: If finer (-180 micron) fraction of PREP-41 is not enough size for assay, please add PUL-21.
 Sample Type: Rock Pulp Percussion Drill Core Other _____
 Soil Sediment

Results to: Takumi ONUMA Certificate QC certificate
 Email: onuma.takumi@sred.co.jp Data file
 Address: 8-21, 3-Chome, Toranomon, Minato-ku Webtrieve only
 City: TOKYO State _____
 Country: JAPAN ZIP 105-0001 Invoice cc

Copy to: Toahiharu TASHIRO Certificate QC certificate
 Email: tashiro.toahiharu@sred.co.jp Data file
 Copy to: Ioki SUZUKI Webtrieve only
 Email: suzuki.iori@sred.co.jp Invoice cc

Invoice to: Ioki SUZUKI
 Email: suzuki.iori@sred.co.jp
 Address: Sumiko Resources Exploration & Development Co., Ltd
8-21, 3-Chome, Toranomon, Minato-ku, TOKYO 105-0001 JAPAN

Sample Return
Pulps Return after analysis Return after 90 days Discard Paid Storage
Rejects Return after 45 days Discard Paid Storage
 Failure to indicate storage instructions will result in paid storage of samples
 Return address: _____

Authorized by: _____
 Name: Ioki SUZUKI
 Signature: _____

Samples ID's		Quantity	Sample Preparation Required (Prep Code)	Analytical (Elements or Method Code)	Service option	
FT01	FT57 FK01 FK43	100	PREP-41	Au-TL43, ME-MS61r	<input type="checkbox"/> RUSH (2x LIST PRICE) CONTACT THE LAB TO CONFIRM AVAILABILITY	
GT01	GT86 GM01 GM17	103	PREP-41	Au-TL43, ME-MS61r		
HT01	HT43 HM01 HM48	91	PREP-41	Au-TL43, ME-MS61r		
HS01	HS41	41	PREP-41	Au-TL43, ME-MS61r		
IM01	IM93 IS01 IS97	190	PREP-41	Au-TL43, ME-MS61r		
JM01	JM40 JS01 JS42	82	PREP-41	Au-TL43, ME-MS61r		
KT01	KT54 KM01 KM49	103	PREP-41	Au-TL43, ME-MS61r		
Total samples		710				

www.alsglobal.com

Figure 3-7 Sample submittal form of ALS Chemex (South Africa)

Commercial Invoice

Senders physical address	KOREAN GARDEN LODGE, LILONGWE MALAWI	Receivers physical address	ALS MINERALS, VEERON KOO, 53 ANGUS CRESCENT, LONG MEADOW BUSINESS PARK, EAST ENTRANCE, ADVENTVALE
Company name	JICA	Company name	ALS MINERALS
Street		Street	
Town / Area code	LILONGWE	Town / Area code	JOHANNESBURG
State country	MALAWI	State country	SOUTH AFRICA
Contact name	IOKI SUZUKI	Contact name	VEERONA JO KOO
Contact tel. no.	+265998311674	Contact tel. no.	+27116080555
E-mail		E-mail	
Airway bill number	5414781831	Total pieces	5
Total Weight	KGS 106	Carrier	DHL

Details of goods

Quantity	Description (Include serial numbers)	Unit cost	Total Cost
1	SOIL SAMPLES	\$500	\$500
		TOTAL	\$500 \$500

Reason For Export HOME USE
Declaration I hereby declare that the above goods to be non-hazardous for air transport

Signatures

Name	Ioki SUZUKI	Signature	
Position in the company		Date	09/09/2015

Figure 3-8 Commercial invoice of DHL

After confirming our packages, work-order detail and samples with the person in charge at the laboratory, a work-order confirmation sheet will be informed (Figure 3-9).

On completion of analysis results will be sent in PDF and Excel format from laboratory (Figure 3-10) with certification and QA/QC information.

**WORKORDER
CONFIRMATION FOR
JBI 5141326**

Print date Sep 21, 2015
Client Code SUREX
Page 1 of 2

To: Ioki Suzuki
Sumiko Resources Exploration & Development Co. Ltd
8-21, 3-Chome
Toranomon, Minato-ku
Japan 1050001

WO Billing address:
Ioki Suzuki
Sumiko Resources Exploration & Development Co. Ltd
8-21, 3-Chome
Toranomon, Minato-ku
Japan 1050001

WORKORDER DISTRIBUTION

REPORT DESCRIPTION	DESTINATION PERSON	DELIVERY
A4 version of the COA	Mr. Takumi Onuma	Email
A4 QC Certificate	Mr. Takumi Onuma	Email
A4 version of Client WOKO	Mr. Takumi Onuma	Email
ALS Minerals Standard CSV format	Mr. Takumi Onuma	Email
ALS Minerals Standard XLS Format with C	Mr. Takumi Onuma	Email
A4 version of the COA	Ioki Suzuki	Email
A4 QC Certificate	Ioki Suzuki	Email
A4 version of Client WOKO	Ioki Suzuki	Email
A4 Invoice	Ioki Suzuki	Email
ALS Minerals Standard CSV format	Ioki Suzuki	Email
ALS Minerals Standard XLS Format with C	Ioki Suzuki	Email
A4 version of the COA	Toshihara Toshiro	Email
A4 QC Certificate	Toshihara Toshiro	Email
ALS Minerals Standard CSV format	Toshihara Toshiro	Email
ALS Minerals Standard XLS Format with C	Toshihara Toshiro	Email

Samples submitted by: Takumi Onuma Total Samples Received: 200
Project: Malawi 2015 Pulp Disposition: Dump after 90 Days
P. O. #: Reject Disposition: Dump
Sample Type: Sediment First Sample Description: FT01
Date Received: September 16, 2015 Carrier and Waybill: DHL 5414781831
Sample Origin: Japan

ANALYTICAL WORK REQUESTED:

200 LOG-22 PREP Sample login - Ref w/o BarCode
200 SCR-41 Screen to - 180um and save both
200 WED-21 Recieved Sample Weigh
Analytes Requested: Recvd Wt

Figure 3-9 Work-order confirmation form of ALS

- 27 / 52 -



ALS Minerals
Johannesburg is a SANAS Accredited Testing Laboratory, No: T0587

Page: 3 - A
Total # Pages: 6 (A - E)
Plus Appendix Pages
Finalized Date: 9 JAN 2015
Account: SUREX

Project: Malawi 2014

Certificate of Analysis JBI4175566

Sample Description	Method Analyte	Unit		Result															
		mg/kg	g/t	1	2	3	4	5	6	7	8	9	10	11	12	13	14	15	16
AT01	0.12	0.001	<0.01	4.02	1.7	480	0.64	0.00	1.00	0.00	0.00	0.00	0.00	0.00	0.00	0.00	0.00	0.00	0.00

* Not SANAS Accredited ** See Appendix Page for comments regarding this certificate ****

Figure 3-10 Analysis results from ALS laboratory

4. Data interpretation

Regional geochemical survey as in reconnaissance exploration process, like our survey, leads us to target area selection after identifying regional geochemical anomalies by data interpretation (Fig.4-1, blue-colored columns are corresponding to our survey). Statistical analysis diagrams and spatial visualizations (GIS mapping) are useful tools for mineral exploration.

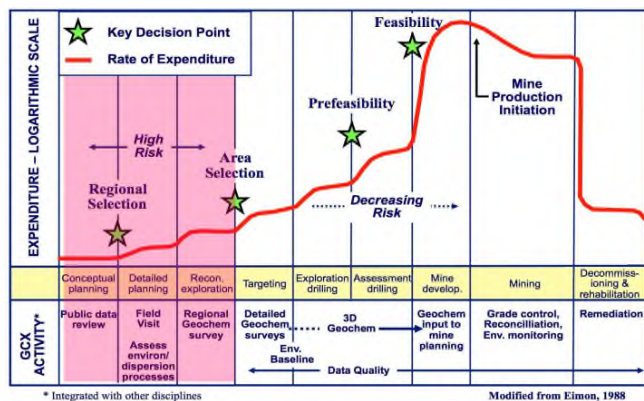

Figure 4-1 Geochemistry in the mineral exploration process (from Closs, 2012)

4-1. Data treatment-grouping

To identify regional geochemical property and to define the regional anomalies, 33 elements, which are economically interesting, are selected from the whole 61 elements identified in the analysis as shown in the box below and Fig.4.2. The selected elements are categorized in several groups to make the anomalous distribution clearer (e.g. LREE [Light Rare Earth Elements; La, Ce, Pr, Nd, Sm, Eu], HREE [Heavy Rare Earth Elements; Sm, Tb, Gd, Dy, Ho, Er, Tm, Yb, Lu], Nuclear metals [U, Th], and Coltan metals [Nb, Ta]). These 33 elements are expected for the survey area, because already have documented in anticipate survey but not detailed.

33 selected elements (6 Groups) from 61 analyzed elements	
Group-1 Major Industrial Metals (11);	Ti, Cr, Mn, Fe, Ni, Cu, Zn, Mo, Sn, W, Pb
Group-2 Precious Metals (2);	Ag, Au
Group-3 Nuclear metals (1);	U
Group-4 Other documented economic elements in Malawi (5);	P, Zr, Sr, Nb, Ba
Group-5 REE (8);	Y, LREE [La, Nd, Sm,], HREE [Gd, Tb, Dy, Yb]
Group-6 Pegmatite associated elements (6);	Li, Be, V, Co, Ta, Bi
Remain elements (28);	Na, Mg, Al, S, K, Ca, Sc, Ga, Ge, As, Se, Rb, Cd, In, Sb, Te, Cs, Ce, Pr, Eu, Ho, Er, Tm, Lu, Hf, Re, Tl, Th

[Box: 33 elements to be selected]

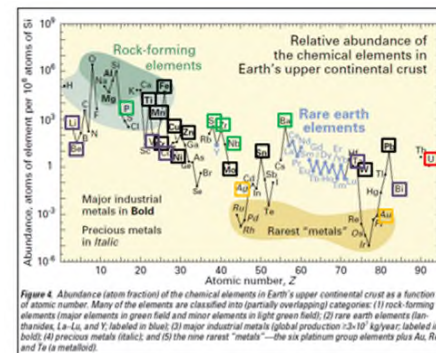

USGS(2002)

Figure 4-2 Selected 33 elements (squared) on plots of relative abundance of upper continental crust

4-2. Histogram and threshold determination

Generally, geochemical anomalies have been identified by setting threshold values, which mark the upper and lower limits of normal variation for a particular population of data. Values within the threshold values are referred to as background values and those above (positive) or below (negative) as anomalies. In mineral exploration interest is generally in positive anomalies, on the assumption that ore deposits and their weathering have increased element abundances above normal crustal levels. However, negative anomalies can also be important, for example where they reflect depletion in some elements during host rock alteration accompanying ore formation (McQueen, 2006).

To establish above mentioned positive threshold value statistically, in the first step, examine univariate statistical methods, which organize and extract information from a data set of values for a single element, with diagrams of 1) frequency histogram, 2) cumulative frequency and 3) box-whisker plots. Those diagrams are generated by EXCEL2010 (Microsoft Office), XLSTAT2014 (Addin software), Cum_Freq (original) and Grapher-11 (Golden Software).

a. EXCEL 2010 from original data
• #1 Values less than lower detection limit >>> use half value of detection limit
• #2 Values more than upper detection limit >>> use the value of upper detection limit
• #3 Folder preparation of respective survey area >>> GC01-02, GC03-04, and GC05
b. XLSTAT 2014 (new installation)
• Descriptive statistics recording
c. Cum_Freq.exe (new installation)
• Cumulative frequency and sorting data of every analyte
>>> AR01 csv, ARD1_cum_Au.csv and ARD1_sort_Au.csv
d. Grapher 11 (new installation)
• Histogram graph >>> Data distribution
• Cumulative frequency graph >>> Threshold value determination
e. Arc GIS 10.2.2 (upgrade)
• Geochemical mapping by bubble plot expression
f. XLSTAT 2014 (new installation)
• Multivariate analysis (Factor analysis)
• Interpretation of geological factor of analyte distribution in survey area

[Box: Software and function to be used for interpretation process]

(1) Statistical summary and diagrams of frequency histogram with cumulative frequency

Table 4-1 shows a table of statistical summary of whole selected elements of GC01-02 (Chitipa-Misuku area), and Figure 4-3 shows an example of those diagrams from GC01-02 and determined positive threshold value (34 ppm) in 2014 survey.

The statistical process is as follows;

- 1) In the original analysis data, there can be values that are not compatible to run the using above mentioned statistical software successfully. Those values are typically character strings indicating a value smaller than the lower detection limit (e.g. "<5") and one greater than upper detection limit (e.g. "10,000<"). Replace the former with the half value of lower detection limit and latter with the upper detection limit itself when preparing the data in EXCEL 2010 (.xlsx and converted .csv files).
- 2) Open XLSTAT-2014, an EXCEL add-in, and select the univariate plots command to obtain the table of descriptive statistics (summary statistics, Table 4-1) with box-whisker plots of selected elements.
- 3) Using "Cum_Freq" and converted csv file (simply edited Excel spread sheet of matrix of element name and analyzed value) prepare sorted file (-sort-.csv) and cumulative plot files (-cum-.csv) of every element (Au, Ag, Ba, Be.....) to the original folder automatically.
- 4) Browsing the posterior cumulative plot file (whichever, -cum-.csv) into the worksheet on Grapher-11, and select "Class scatter plot" graph and axes with probability plot (Y-axis) and log10 plot (X-axis) with some adjustments (range, size, axis name, dot color etc.) to complete "Cumulative frequency diagram" style, and save it as gpj file format ("Grapher project file", which means save attached with original worksheet). Hereafter click the plot then browse other element csv file by left property box and automatically change to new plot on the same diagram style, and save as other name gpj file, then continue same steps up to cover all data.
- 5) On the obtained graph expressed the probability plots, check in the righter (higher value) part of the plot to determine the positive threshold value on some overlapped, reflected or gapped position between populations, which ideally are expressed one log normalized domain in flat distribution of this plot, considering with upper continental crust value (Clark number) and other diagrams of histogram and box-whisker plots.
- 6) To obtain the frequency histogram on Grapher-11, open xlsx format file of analyzed result table and select "histogram" graph with axes of linear (Y-axis) and log(base10)(X-axis), then modify the style and save it in gpj format as well. After saving this original graph, select next element on

"Data column" to show the second new plot...

Table 4-1 Summary statics and criteria of GC01-02 of 33 elements by XLSTAT-2014

Summary statistics GC01-02												0208_revised			
Variable	Unit	Observations	Minimum	Maximum	Mean	Std deviation	M	Mod	Max-1.5s	Threshold					
Au	ppm	106	0.001	0.012	0.0016	0.0013	0.0016	0.0028	0.0035	0.0000					
Ag	ppm	106	0.005	0.800	0.0654	0.1340	0.0654	0.2195	0.2865	0.1700					
Ba	ppm	106	130.000	2420.000	686.6961	369.3354	686.6961	1092.0335	1234.7012	1090.0000					
Be	ppm	106	0.350	3.180	1.1367	0.9490	1.1367	1.6886	1.9633	2.5000					
Bi	ppm	106	0.010	0.330	0.0862	0.0561	0.0862	0.1453	0.1733	0.1300					
Ce	ppm	106	50.100	500.000	159.9302	97.7831	159.9302	257.7132	306.6046	245.0000					
Co	ppm	106	4.900	79.000	27.2640	13.9974	27.2640	41.2813	46.2500	47.5000					
Cr	ppm	106	22.000	822.000	136.7364	124.5703	136.7364	263.2997	320.3819	280.0000					
Cu	ppm	106	2.200	84.700	25.0392	13.3649	25.0392	35.9949	41.1184	34.0000					
Fe	%	106	1.610	25.200	6.2352	4.2091	6.2352	12.4403	14.5559	14.0000					
La	ppm	106	22.200	910.000	67.4943	67.5367	67.4943	114.8300	169.4878	97.4000					
Li	ppm	106	2.700	14.680	5.6708	2.6251	5.6708	8.2956	9.6084	10.0000					
Mn	ppm	106	256.000	8700.000	1897.9057	1750.7120	1897.9057	3551.6177	4526.4737	4385.0000					
Mo	ppm	106	0.330	2.710	1.2387	0.8553	1.2387	1.7940	2.0716	2.0000					
Nb	ppm	106	5.200	500.000	79.2867	102.4136	79.2867	161.8022	233.0590	300.0000					
Ni	ppm	106	5.300	158.500	36.0300	25.2678	36.0300	61.3178	73.9517	65.6000					
P	ppm	106	70.000	2200.000	494.2455	335.1316	494.2455	820.3769	983.4426	965.0000					
Pb	ppm	106	5.800	19.100	12.4657	3.3377	12.4657	16.7934	17.4622	18.1000					
Sr	ppm	106	0.800	6.700	2.2743	1.2506	2.2743	3.5256	4.1362	5.0000					
Sr	ppm	106	29.500	742.000	274.0972	156.1457	274.0972	432.2425	511.3157	260.0000					
Ta	ppm	106	0.250	56.200	4.9799	7.2408	4.9799	12.2207	15.8411	15.0000					
Ti	%	106	0.258	10.000	1.7654	1.5310	1.7654	3.2964	4.0619	2.7000					
U	ppm	106	0.400	15.200	3.0962	2.6110	3.0962	5.9072	7.3127	9.0000					
V	ppm	106	36.000	594.000	192.2642	89.3626	192.2642	291.6487	326.3380	350.0000					
W	ppm	106	0.100	2.700	1.0206	0.5646	1.0206	1.5753	1.8526	2.0000					
Y	ppm	106	9.300	87.000	25.6359	12.3752	25.6359	38.0141	44.2032	23.0000					
Zn	ppm	106	17.000	163.000	65.2630	29.7410	65.2630	93.0340	109.8946	106.0000					
Zr	ppm	106	27.400	428.000	103.4536	73.9795	103.4536	177.4325	214.4220	300.0000					
Dy	ppm	106	1.940	26.400	6.0043	3.7357	6.0043	9.7400	11.6079	13.8000					
Er	ppm	106	0.660	7.860	2.7202	1.2093	2.7202	4.0195	4.6692	6.2000					
Eu	ppm	106	0.590	10.400	2.4876	1.4865	2.4876	3.9750	4.7203	5.0000					
Gd	ppm	106	1.980	57.000	6.6366	7.5331	6.6366	16.1699	19.9365	16.0000					
Hf	ppm	106	0.330	3.710	1.0379	0.5619	1.0379	1.5996	1.9807	2.0000					
Lu	ppm	106	0.070	1.060	0.3440	0.1560	0.3440	0.5020	0.5910	0.6000					
Hd	ppm	106	16.300	391.000	60.1717	53.0476	60.1717	113.2193	139.7432	100.0000					
Pr	ppm	106	4.750	116.500	16.1626	15.2636	16.1626	31.4262	39.0581	20.0000					
Sm	ppm	106	2.690	66.300	10.6854	9.1480	10.6854	20.0314	24.6044	15.0000					
Tb	ppm	106	0.310	5.760	1.1411	0.6413	1.1411	1.9824	2.4031	2.5000					
Tm	ppm	106	0.070	1.130	0.3522	0.1653	0.3522	0.5174	0.6001	0.6000					
Yb	ppm	106	0.420	7.030	2.1649	1.0135	2.1649	3.1784	3.6651	4.0000					

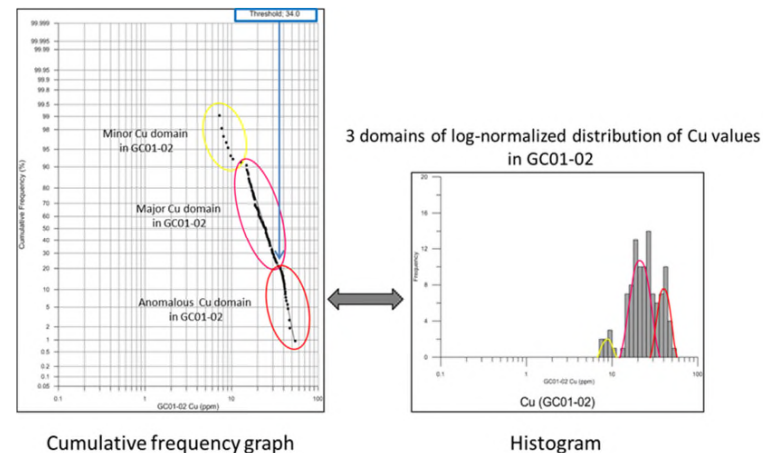

Figure 4-3 Diagrams of cumulative frequency (left) and frequency histogram (right) of Cu in GC01-02

These diagrams of frequency histogram and cumulative frequency can help identify the type of distribution of the data, presence of multiple populations and outliers in the distribution. In case of Figure 4-3 shows the 3 domains of population in Cu concentration including anomalous domain (a set of value more than 34ppm), which is just positive anomaly in GC01-02.

Statistical methods mentioned above have been widely applied to interpret geochemical data sets and define anomalies. Such methods need to be used cautiously because of the particular characteristics of geochemical data. Geochemical data sets seldom represent a single population or distribution; the data are typically spatially dependent and at each sample site a range of different processes have influenced the element abundances measured. The data are also imprecise due to unavoidable variability in sampling methods and media and the level of analytical precision. As a result no single method universally applicable statistical test has been developed for identifying anomalies. Statistical investigation should use a range of techniques to explore the nature of geochemical data before selecting anomalous values (McQueen, 2006).

(2) Box and whisker plots

Box and whisker plots are another convenient way of examining the frequency distribution of a data set and for comparing the frequency distributions of multiple data sets. This type of plot shows the median (middle value or 50th percentile), a box with upper and lower hinges (or limits) defined by the 75th and 25th percentile values respectively (i.e. upper and lower quartile values), an inner fence defined as 1.5 times the length of the box (the interquartile range) towards maximum and minimum values and whiskers extending to the maximum and minimum values. The central box will contain 50% of the data. Values below the whiskers are considered outliers and values more than 3 times the interquartile range (length of the box) from the box hinges are referred to as far outliers (McQueen, 2006, Figure 4-4).

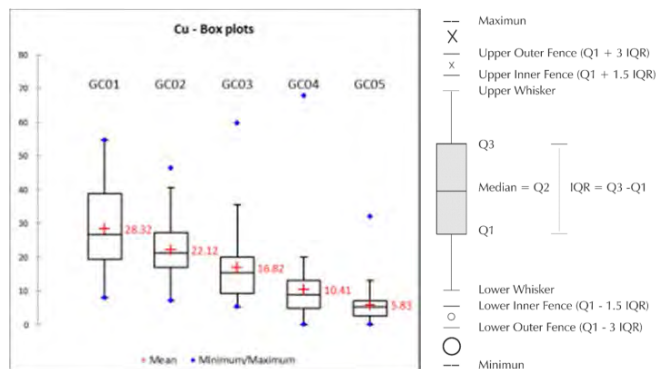

Figure 4-4 Comparative box and whisker plots of Cu in GC01-05

4-3. Geochemical mapping

As one of common software for geographical Information Systems (GIS), i.e. ArcGIS TM, have excellent tools to analyze and visualize the spatial distribution of data, and has been used extensively in the analysis of large geochemical data sets (Gutiérrez et al, 2012). The main strength of ArcGIS is that it allows the spatial management of a database where data can be analyzed, grouped or intersected to any other thematic information geographically represented (layers).

This analysis / mapping utilizes the following layers: geographic coverage of concentrations for each target element (with five sizes of bubble symbols representing from background to anomalies), map layers for geology, motorable routes, and one of hydrology (detailed river system), inclusive of survey area polygon layer. The geochemical anomalies (beyond positive threshold value) were shown visually by symbology combination of color (red) and bubble size (Fig.4-5).

Inspection of both the anomaly map with layers of hydrology, geology and field observation data of every sampling site help you identify the features that could explain the presence of the observed anomalies from field evidences, such as lithology, mineralization, and particular mineral occurrences (soil-clay, magnetite, garnet etc.).

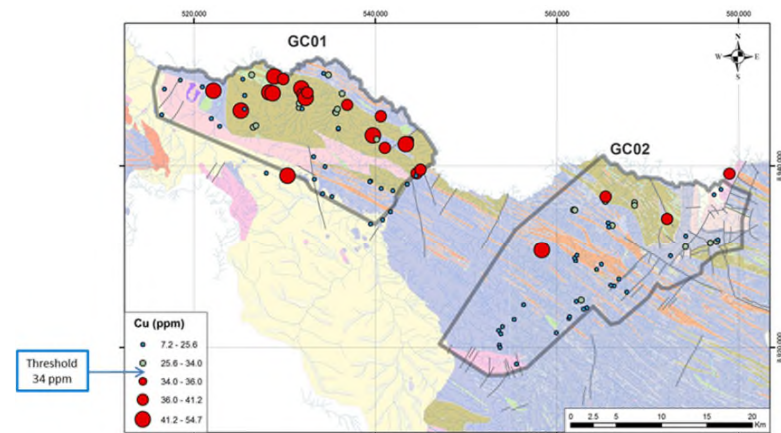

Cu (major industrial metals): associated with mafic/felsic intrusions in amphibole gneiss basement (brown area)

Figure 4-5 Geochemical mapping with bubble plot of Cu in GC01-02

Fig.4-5 shows the Cu broad anomaly distribution in GC01 clearly corresponding to, herein, brown colored lithology (amphibolite intrusion bearing amphibole gneiss in basal metamorphic complex). It had been highly expected already in the phase of field campaign, with common occurrences of the small but visible Cu-oxide halo (green copper) with original Cu-sulphide particles (Fig.4-6).

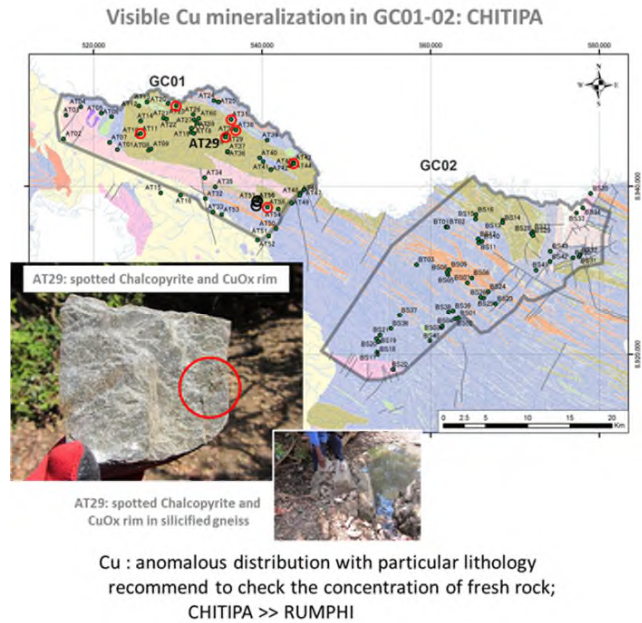

Figure 4-6 Location map of the visible Cu mineralization in GC01

Additionally Nb anomalies in GC01, which is located along Mugesse shear zone with Songwe syenite, seem to correspond to magnetite and other heavy mineral layering concentration in sampled sediment derived from syenite intrusion (Ilomba hill syenite etc., Fig.4-7).

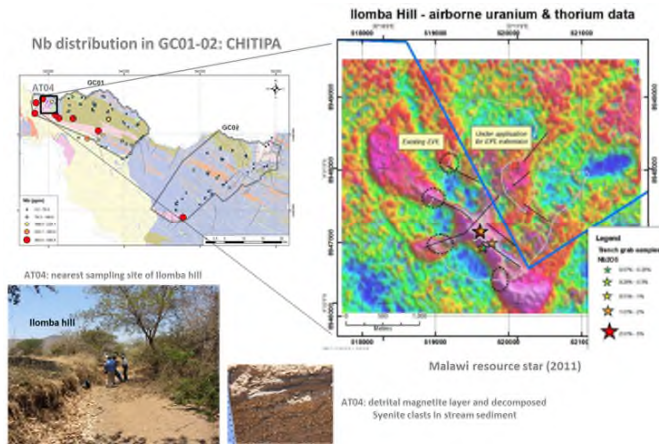

Figure 4-7 Nb anomaly and heavy mineral occurrence in sampled sites in GC01

4-4. Multivariate analysis

Factor analysis was applied to 33 selected elements, after log-transformed process of the whole data set, for which the Pearson correlation coefficients between pairs were also calculated, to extract controlling factor of distributions statistically using the Statistical Package of XLSTAT-2014.

In factor analysis, the total variance contained in each factor is re-expressed by the Eigen value provided by the principal component solution as an initial set of uncorrelated linear transform of the original variables. The factor loadings, which can be considered as a combination between the elements, were computed after rotating the original principal component solution according to the Quartimax rotation method with Kaiser's normalization (table style). Factor score coefficients were tabulated and used to obtain cumulate factor scores. The correlation matrixes of factors are also shown in table style. For this survey, variables with loadings of greater than 0.70 are considered in significant groups of a particular factor (Ovie Odokuma-Alonge and John Adeyinka Adekoya, 2013).

The results of the factor analysis of 106 samples data set (GC01-02) for the 33 elements, which constitute the variables in the analysis, are summarized using the Quartimax method. It shows factor loading, Eigen values, variance cumulative % and the communality obtained from a six-factor model (Figure 4-8). The communality is an indication of the total variability of each element explained in a given factor model. The six-factor model explained 84% of the total variance.

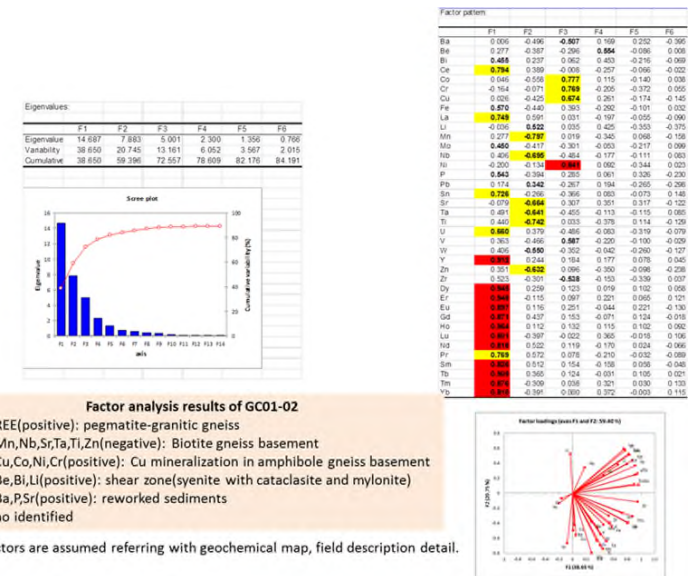

Figure 4-8 Factor analysis results of 33 elements in GC01-02

The correlation matrix for the data obtained (Figure 4-9) shows a wide variation in the correlation coefficient (r) between element pairs. For example, the r values range from -0.467 between Cr and Ba to 0.994 between Nd and Pr. Fairly strong to very strong positive correlation occurs among REE, Coltan and nuclear metals (Nb, Ta, U, Th), which is attributable to natural association of lithophile elements. Other elements which include Ni, Co, Mo, Cr, Pb, Cu, Zn, Ag, As, Sb, Hg, Bi and Co indicate siderophile and chalcophile associations. In the stream sediments, six factors with element associations were identified as the most meaningful solutions in terms of known geology, surficial environment and mineralization.

- Cu: Co, Ni, Cr, V, P(positive)
- REE: REE and U, Sn, P, Bi(positive)
- Ta: Nb(positive)
- Ti: Mn(positive)
- Fe: V(positive)

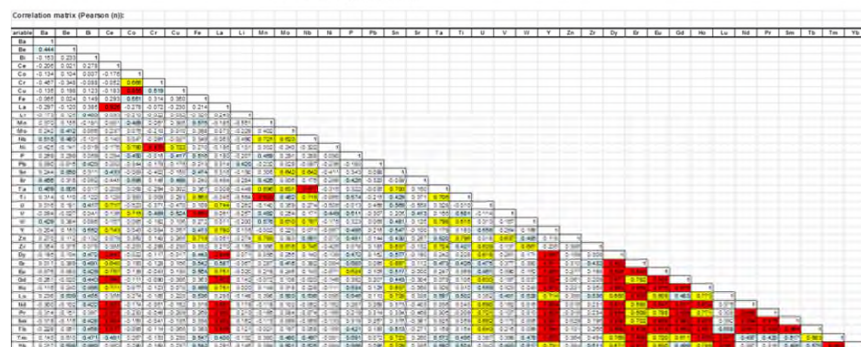

Figure 4-9 Correlative coefficient matrixes of 33 elements in GC01-02

As shown in Figure 4-8, the results of the six-factor model extracted from the log-transformed data are summarized below:

Factor 1: (REE). This is the most pronounced factor which accounts for 38.65% of the model variance and probably defines a combination of both mineralization and lithology. It essentially indicates a complex pegmatite and granitic rock lithology with veins and dykes being the source of the aforementioned trace elements.

The association of Ag-Bi-Sr-Pb-Nb and Cu suggests the occurrence of probable sulphide mineralization. The very strong positive correlation of V, Sc, Mo, Ni, Co and Cr is probably indicative of the occurrence of mafic and ultramafic rocks within the study area.

Factor 2: (Mn-Nb-Sr-Ta-Ti-Zn). This is the second factor, but negative, and accounts for 20.745% of

the model variance and seems to reflect the negative influence of the parent rock (biotite gneiss). Therefore the fairly strong negative correlation suggests a syenitic intrusion lithology in the area.

Factor 3: (Co-Cu-Cr-Ni). Factor 3 accounts for 13.161% of the variance of the six-factor model. The fairly strong positive correlation between them apparently suggests the presence and influence of an amphibolite intrusions in amphibole gneiss basement with posterior minor felsic intrusions. In fact several spotted occurrences of Cu sulphide mineralization were recognized with these lithofacies in field campaign.

Factor 4: (Be-Bi-Li). This factor accounts for 6.052% of the model variability and is considered a mineralization factor associated with the syenite bearing shear zone with cataclasite-mylonite zone (Songwe shear zone). This association seems to be influenced by secondary supply along the shear zone such as alteration or stock work veining.

Factor 5: (Ba-P-Sr). This factor accounts for 3.567% of the model variability, and is assumed to be sedimentary concentration with reworked sediments such as terrace-alluvial fan by these distribution.

Factor 6: (no identified). It is not probable extract fair correlation.

Factor analysis using EXCEL-STAT-2014 shows the two analysis results. One is the correlative coefficient matrix on every two elements (Fig.4-8), and the other is six extracted principal factors that explained 84 % of the cumulative variability in whole analysis element concentration of GC01-02 (total 106 samples) in this case, as shown in Fig. 4-9.

It was grouped into six associations, such as;

- F1: REE (Rare Earth Elements, positive),
- F2: Mn-Nb-Sr-Ta-Ti-Zn (negative),
- F3: Co-Cu-Cr-Ni (positive),
- F4: Be-Bi-Li (positive),
- F5: Ba-P-Sr (positive)
- F6: no identified group

Those results seem to be concordant with anomaly distribution, as each element appears in a different principal group, except for Sr in F2 and F5, which show an independent behavior of respective element group by same controlling factor. After examining the anomaly distributions, primary lithological control and secondary geological processes-agents described in field campaign (mineralization, alteration, weathering etc.), the factors are assumed to identify the following.

- F1: REE (Rare Earth Elements)-----Pegmatite and granitic gneiss,
- F2: Mn-Nb-Sr-Ta-Ti-Zn -----Syenitic intrusions,
- F3: Co-Cu-Cr-Ni-----Cu mineralization associated with amphibolite intrusions in amphibole gneiss basement,
- F4: Be-Bi-Li-----Syenite bearing shear zone with cataclasite-mylonite,
- F5: Ba-P-Sr-----Reworked sediments(weathering)
- F6: no identified group

The top three factors could explain well the anomaly distribution of participant elements by coincidence between the field observation and lithological variation, which seems to be evaluated well the adequate area selection to express the entire anomaly distribution. On the other hand, it means, the rest of the element groups were not profiled-explained well in this survey area selection.

Anomaly maps provide a visual product that facilitate the identification of concentrated areas, and point-out the specific areas in which the efforts for detailed geochemical exploration should be focused on, and also corresponding commodities resulted by statistical analysis, as mentioned above.

Three obtained regional analyses are summarized in Fig.4-10. Detected in all survey areas are the first REE group associated with pegmatite-granitic rocks and Cu-(Co)-Ni-Cr group concentration associated with amphibole-biotite gneiss basement. Those two groups represent the principal component or commodity in the whole survey area to explore, it is assumed.

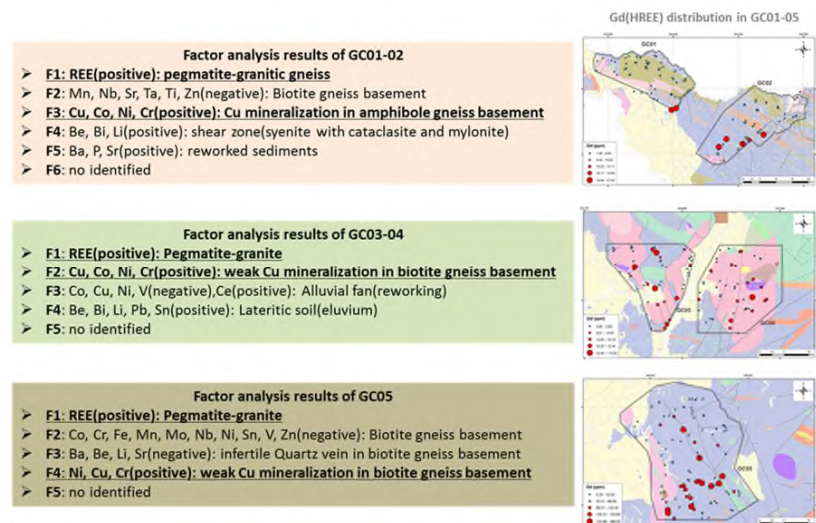

Figure 4-10 Analysis summaries of 33 elements in GC01-02, GC03-04 and GC05

4-5. Tools for geological interpretation

1) Box-whisker plots

As shown in 4.2(2), box-whisker plots generated by XLSTAT-2014 are available to visually summarize the distribution property of geochemical variance. In GC01-05, as is shown in Figure 4-11(319 samples), the following four distribution patterns are identified.

- A) Base metals etc. (Cu-Fe-Cr-Co-Ni-Ti-V): Element group descending from GC01 to GC05
- B) REE (LREE: Ce-La-Y-Eu-Nd-Pr-Sm, HREE: Dy-Er-Gd-Ho-Lu-Tb-Tm-Yb) and nuclear metals etc.(U-Th-Zr-P-Be-Li): Element group rather ascending from GC01 to GC05
- C) Coltan metals etc.(Nb-Ta and Mn-Mo-Pb-Sn-W-Zn-Ba-Sr-Ag): Element group concentrated in GC03-04
- D) Others (Au-Bi): Element group of non-characteristic distribution pattern

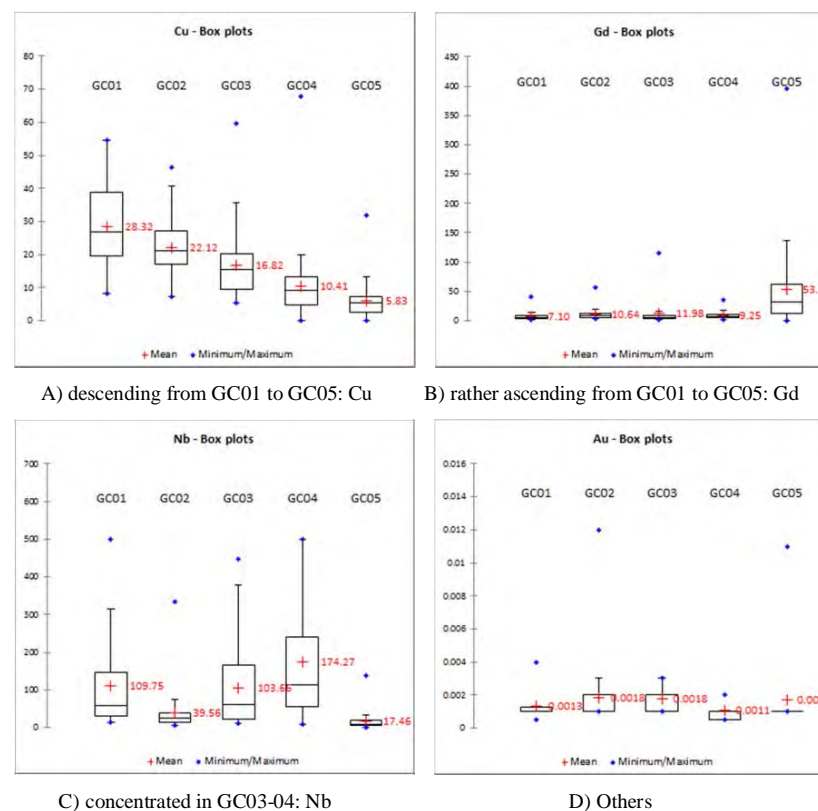

Figure 4-11 Characteristic element distribution pattern of GC01-05 (unit: ppm)

2) Correlative plots

Correlative plots generated by EXCEL show also variety of data distribution particularly in correlation coefficient value (X^2 ; 0.3769-0.4844-0.7067) of linear approximate equation depending on source population and size (Figure 4-12). Within GC01-05, which included Cu mineralization in GC01, correlative plots record the highest coefficient value than others (left above plots of the figure).

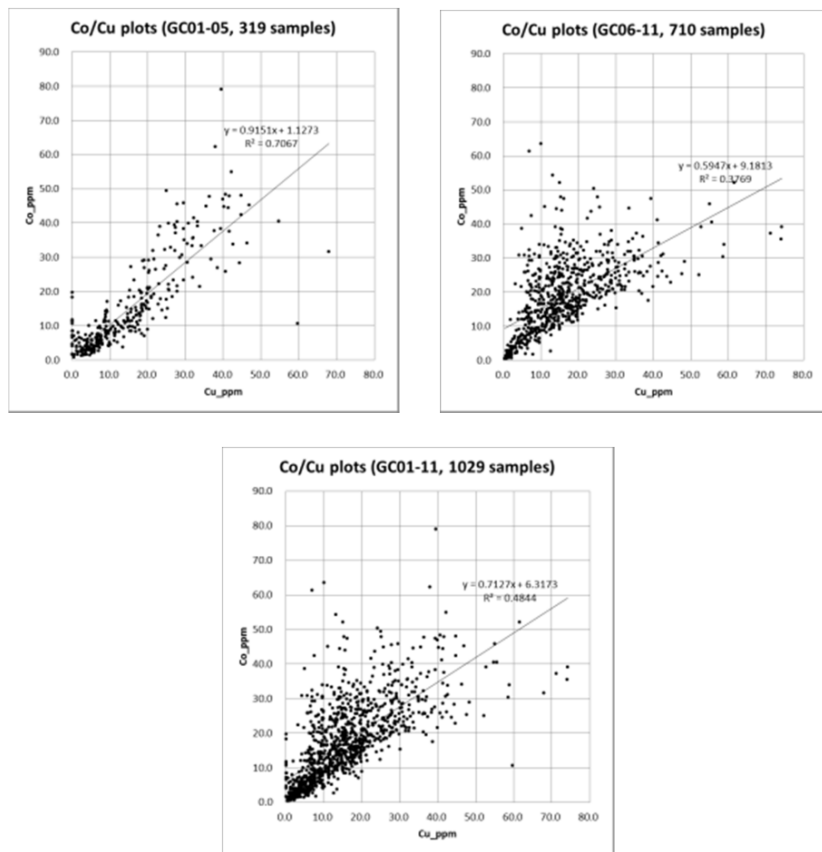

Figure 4-12 Correlative plots example of Co/Cu with regional transition (EXCEL 2010)

3) Chondrite normalized REE pattern plots

Chondrite-normalized REE patterns generated by EXCEL for GC01-05 (Figure 4-13, Table 4-2) are generally slightly concave-up with small negative Eu anomalies. Comparing with world-class REE deposit data by Takagi (2013) at the background of plots, chondrite normalized REE patterns for GC01-05 show the near equal concentration of LREE values and 10-50% leveled concentration in HREE with Chinese ion-absorbed type regolith hosted REE mines (Figure-4-13).

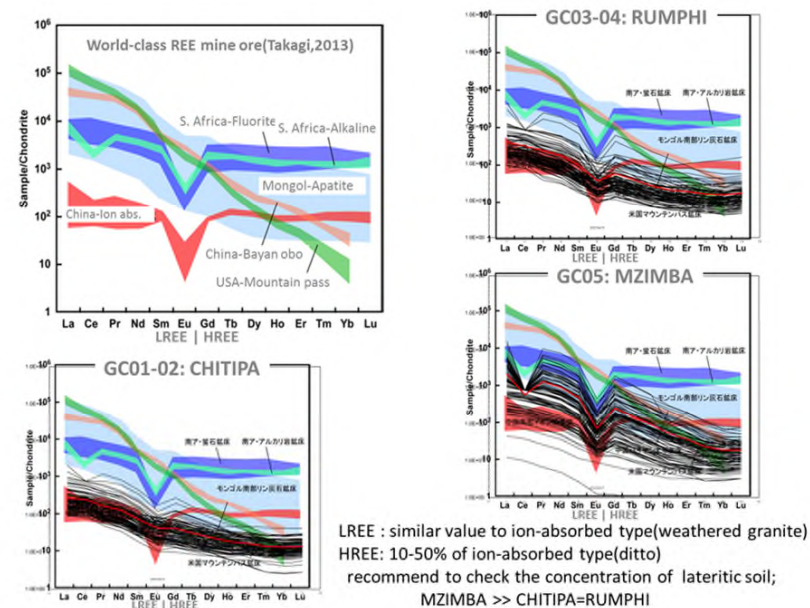
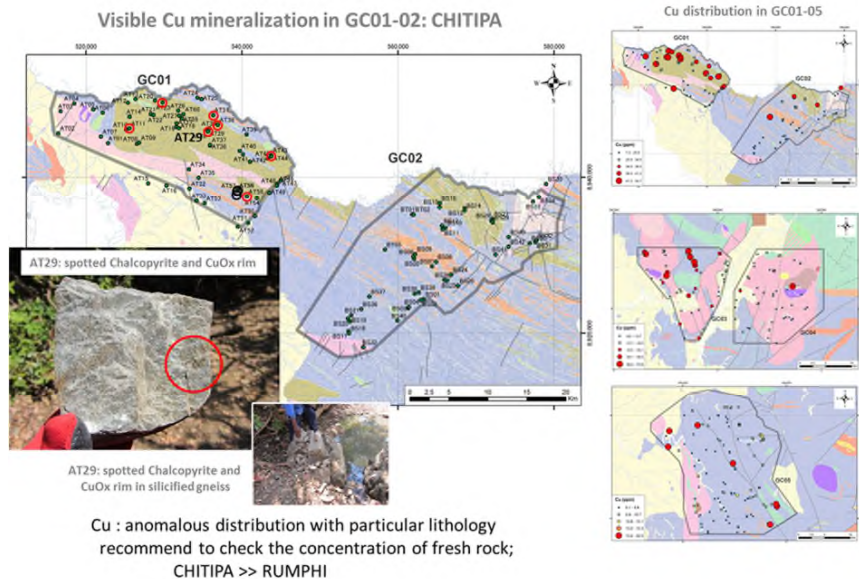

Figure 4-13 REE patterns in stream sediments normalized to the concentrations in chondrite

Table 4-2 Abundances of REE in C1 chondrite (McDonough and Sun, 1994)

Ci: McDonough and Sun, 1994	
La	0.2370
Ce	0.6130
Pr	0.0928
Nd	0.4570
Sm	0.1480
Eu	0.0563
Gd	0.1990
Tb	0.0361
Dy	0.2460
Ho	0.0546
Er	0.1600
Tm	0.0247
Yb	0.1610
Lu	0.0246

4) Field observation based interpretations



- 35/52 -

5. Reporting

At the completion of each year's work of field campaign, chemical analysis, and the data interpretation procedure the field operation manager will be responsible for writing a report on whole geochemical survey. This report will act as the definitive record of the cooperation between GSD and JICA team on entire fieldwork activities, geochemical analysis database, interpretation procedure and results, and will provide a reference to the work completed.

The report should have the following sections:

1. Schedule of fieldwork detailing what was done where and when.
2. A simplified map showing the area sampled.
3. A reference to the field description card and manual used.
4. Details of the field team. This should include a table of samplers' initials.
5. Summary table of number of samples collected indicating number ranges.
6. Details of each monitor site samples were collected from.
7. Detail table of chemical analysis results.
8. Whole interpretation procedure and graphical plots with ordering data
9. GIS mapping data and out-put.
10. Drainage geochemical survey manual
11. Overview of whole geochemical survey and highlight/topics of the project
12. Recommendation of forthcoming project area (for detailed geochemical exploration)

Appendix 3-6

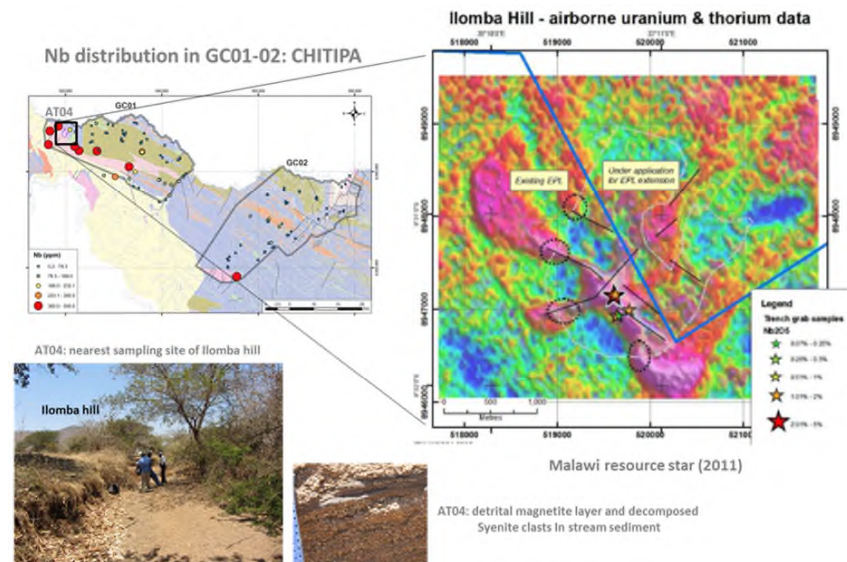

6. References

- Johnson, C.C. (2005). 2005 G-BASE Field Procedures Manual. British Geological Survey Internal Report, IR/05/097. 130pp.
- BGS:British Geological Survey(2009-1) Mineral Potential of Malawi, 1 Mineral deposits associated with alkaline magmatism(rare earth metals, Coltan metals, nuclear metals, phosphate etc.), Ministry of Energy and Mines, Republic of Malawi
- BGS:British Geological Survey(2009-2) Mineral Potential of Malawi, 2 Mineral deposits associated with the Basement metamorphic and igneous rocks(precious and base metals, gemstones and industrial minerals, ditto
- BGS:British Geological Survey(2009-3) Mineral Potential of Malawi, 3 Mineral deposits associated with sedimentary and volcanic cover rocks: Karoo and post-Karoo(coal, uranium, industrial minerals and gemstones), ditto
- BGS:British Geological Survey(2009-4) Mineral Potential of Malawi, 4 Deposits resulting from residual weathering, placer and rift-related sedimentation.(bauxite, saprolitic nickel, Ti±REE±Zr, gold and gemstone placers, etc.), ditto
- Carranza, Emanuel John M. (2009) Geochemical anomaly and mineral prospectivity mapping in GIS, Handbook of exploration and environmental geochemistry 11, edited by M.Hale, Elsevier
- Dill,H.G.(2007) A review of mineral resources in Malawi: With special reference to aluminium variation in mineral deposits, Journal of African Earth Science, 47, 153-173
- Dill,H.G., Ludwig,R.-R., Kathewera,A., Mwenelupembe,J.(2007) A lithofacies terrain model for the Blantyre Region: Implications for the interpretation of palaeo-savanna depositional systems and for environmental geology and economic geology in southern Malawi, Journal of African Earth Science, 41, 341-393
- JICA and SRED (2013) Final report on project for establishment of integrated geographic information system (GIS) database for mineral resources in the republic of Malawi, in Japanese
- Fletcher,W.K.(1997) Stream Sediment Geochemistry in Today's Exploration World, In "Proceedings of Exploration 97: Fourth Decennial International Conference on Mineral Exploration" edited by A.G. Gubins, 1997, p. 249–260
- Ohta,M., Imai,N., Terashima, S., tachibana, Y., Okai,T., Mikoshiba,M., Kubota, R. (2008) A new analytical procedure for elementary distribution in stream sediments using GIS and stastics, Chisitsu News, vol.646, 22-29, in japanese
- Takagi, T.(2013) Resume and current situation of resources of the rare earth element, 2013.11.30, (presentation, in Japanese)
- MacQueen, K.G.(2006) Identifying geochemical anomaly, Australian National University 2006
- Closs, L. Graham(2012) Exploration Geochemistry: Updating Its Contribution to Mineral Resource development, Colorado School of Mines(presentation)
- Cornelius, Matthias, Smith, TRaymond E., Cox, Amenda J.(2001) Laterite geochemistry for regional exploration survey – a review, and sampling strategies, Geochemistry: Exploration, Environment,

- Analysis, vol.1, p.211-220
- Key, Roger M. and De Waele,Bert(2004) A multi-element baseline geochemical database from the western extension of the Central Africa Copper belt in northwestern Zambia, Applied Earth Science(Trans. Inst. Min. Metall. B), vol. 113
- Gordon B. Haxel, James B. Hedrick, and Greta J. Orris(2002) Rare Earth Elements-Critical Resources for High Technology, USGS Fact Sheet 087-02, (<http://geopubs.wr.usgs.gov/fact-sheet/fs087-02/>)
- Sampling method MD2, division of a sample by quartering, from CSIR website, (<http://asphalt.csir.co.za/tmh5/MD2%20-%20Division%20of%20a%20sample%20by%20quartering.pdf>)
- Mélida Gutiérrez, Victor M. Reyes Gómez, Ma. Teresa Alarcón Herrera & Daniel Nuñez López (2012) Exploratory Analysis of Sediment Geochemistry to Determine the Source and Dispersion of Ba, Fe, Mn, Pb and Cu and in Chihuahua, Northern Mexico, Journal of Geography and Geology; Vol. 4, No. 4; 2012
- C.C. Johnson, N. Breward, E.L. Ander & L. Ault(G-BASE: Baseline geochemical mapping of Great Britain and Northern Ireland, (<http://nora.nerc.ac.uk/884/1/GEEAFinalsubmittedmanuscript.pdf#search=site+planning+stream+sediment+geochemistry>)
- Ovie Odokuma-Alonge and John Adeyinka Adekoya (2013) Factor Analysis of Stream Sediment Geochemical Data from Onyami Drainage System, Southwestern Nigeria, International Journal of Geosciences, 2013, 4, 656-661
- Golden Gadianaal Ashan Chizimba Msilimba (2007) A comparative study of landslide and geo-hazard mitigation in northern and central Malawi, Doctor thesis of University of Free State
- Muhammad Shafique, Sarmad Israr, M. Tahir Shah and M. Asif Khan (2014) Remote sensing based strategy of stream sediment sampling for mineral exploration in Peshawar Basin, Khyber Pakhtunkhwa, Pakistan, Journal of Himalayan Earth Sciences Volume 47, No. 2, 2014, pp. 141-148
- NRCS (1991) How to Read a Topographic Map and Delineate a Watershed, (www.nh.nrcs.usda.gov)
- Fluvial Geomorphology (http://www.fgmorph.com/fg_4_1.php)
- Addinsoft TM (2014) XLSTAT version 2014.6.15
- ESRI (2014) ArcGIS version 10.2.2
- Golden software (2014) Grapher-11
- Ravi Anand (2014) Geochemical exploration in regolith-dominated terrains – global perspective, CSIRO, presentation
- Mélida Gutiérrez, Victor M. Reyes Gómez, Ma. Teresa Alarcón Herrera & Daniel Nuñez López (2012) Exploratory Analysis of Sediment Geochemistry to Determine the Source and Dispersion of Ba, Fe, Mn, Pb and Cu and in Chihuahua, Northern Mexico, Journal of Geography and Geology; Vol. 4, No. 4; 2012
- Mark D. Cocker (1996) Distribution of selected elements in stream sediments, stream hydro

-geochemistry and geology of Oconee river basin, Georgia, Bulletin 121, Georgia department of natural resources environmental protection division of Georgia geological survey

Appendixes:

Note: Need to check **Windows/Caspersky** update state of every PC (desktop, laptop), then **ArcGIS license detail(registered document)** too.

- **XLSTAT2014 (2 licenses, installation)** >>> copy XLSTAT.zip(69MB) into My document folder >>> extract opening to same folder >>> open(double-click) XLSTAT.exe >>> select [custom] >>> select [XLSTAT] and [Help] only(macro-function ad-in program for EXCEL, for better security) >>> **installed.** >>> **open XLSTAT with license key [327500045809122651], then open EXCEL file to use(handheld XRF data GC05).** >>> continue.....later
- **Grapher-11(2 licenses, installation)** >>> insert original CD-ROM of Grapher 11 into My document folder >>> install with auto-play process >>> open program and input the serial number labeled on CD cover >>> register in golden software website >>> **installed.** >>> **open Grapher 11 with serial number(mentioned above)** >>> **open example document(Tutorial)** >>> continue.....later
- **Cum_Freq_exe(installation)** >>> copy Cum_Freq_exe. into My document folder >>> **installed.** >>> open (double-click) >>> **open prepared EXCEL csv file to use** >>> select file >>> done >>> create new data(element divided Cumulative frequency & Descending sorted data) in same folder instantly >>> folder classification >>> **OK.**

- **Arc GIS 10.2.2(upgrade from ver.10)**

note: [SU license=Single User], [license confirmation sheet=License number]

Pre-installation procedure:

- #1: User account control state [Start/Control panel/User account/User account/User account control modification? >>> no report (temporary)] >>> restart the PC
- #2: uninstallation of former version ArcGIS-1(License cancellation) >>> **internet connection** >>> [Start/All Program files/ArcGIS/Arc GIS Administrator] >>> [Folder tree in left side column/Desktop] >>> [put the below centered "License cancellation button"] >>> [License cancellation of software/Yes] >>> [Software license Wizard/License cancellation in the time via internet/Next/Finish] >>> **internet disconnection**
- #3: uninstallation of former version ArcGIS-2(Uninstallation) >>> [Start/Control Panel/Uninstallation of program] >>> [**first**; uninstallation/Extension tools] >>> [**second**; uninstallation/Japanese aided pack] >>> [**third**; uninstallation/Japanese supplement] >>> [**fourth**; uninstallation/ArcGIS for Desktop] >>>

- **Arc GIS 10.2.2(upgrade from ver.10)**
after completion of License cancellation & uninstallation of former version ArcGIS

Installation procedure:

- #1: copy the folder[arcgis10.2.2; 1.63GB] into My Document of the PC....waiting
- #2: [My Document/ArcGIS/arcgis10.2.2] >>> double click on [ArcGIS_Desktop_1022_ja_140421.exe] >>> [select installation folder(default)/OK] >>> waiting >>> Finish....activation...
- #3: [Set up window/Next/Accept/Next/Complete/Next/ArcGIS 10.2.2 Installation folder(default)/Next/Python installation folder(default)/Next/put Installation button] >>> Starting installation >>> waiting.....>>> Finish
- #4: automatically pop up [ArcGIS administrator Wizard/Cancel(later)] >>> automatically installation of Japanese aided pack(later uninstall)
- #5: supplemental patch installation of [ArcGIS-1022-DT-SSDCP-PATCH.msp] >>> then [ArcGIS-1022-DT-SRC-PATCH.msp] >>> OK !!!

- **Arc GIS 10.2.2(upgrade from ver.10)**
post-installation of ArcGIS 10.2.2

License registration procedure:

- #1: internet connection >>> [Start/All programs/ArcGIS/ArcGIS Administrator] >>> [1. product selection(above right)/Basic(ArcView)(Single User)] >>> [2. submit(below right)] >>> [License admission wizard/...require to admit(top radio button)/Next/admit via internet(top radio button)/Next]
- #2: [Software admission wizard/user data input/Next/User registration select/Next] >>> [input User license number(ESU.....)] >>> [Extension/No]/Next/Evaluation of extension software/Next/.....waiting...../Finish] >>> **Complete!!!** >>> internet disconnection >>> open Arc GIS 10.2.2

XLSTAT-1: Generating box plots with XLSTAT (2015-10-13)

Dataset for generating a box plot

An Excel sheet with both the data and the results can be downloaded by clicking here.

The data correspond to a sample of 150 irises for which 4 variables were measured. The flowers belong to 3 different species. Fisher used this dataset, now famous, when he developed his discriminant analysis theory. In this particular example, we decided to analyze the variable Sepal length of the flowers and to visually check if there are differences between the three species using **box plots** (box-and-whisker plots).

The means ± symmetrical error bars representation is very common while only reliable if the data is normal. On the other hand box plots are adaptable to a broader range of distributions, as they are based on quantiles. Apart from letting you compare several distribution locations and widths with each other, box plots let you check if the distribution is symmetrical or skewed, if there are outliers in the data, as well as the location of the mean within the distribution.

Setting up the dialog box for the box plot

Once XLSTAT is open, select the **XLSTAT / Visualizing data / Univariate plots** command, or click on the **Descriptive statistics** button of the **Describing data** toolbar (see below).

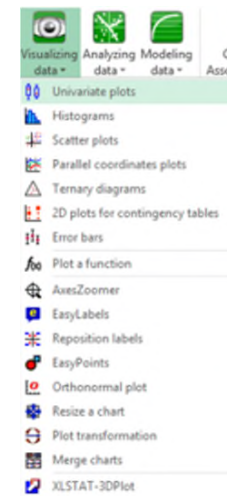

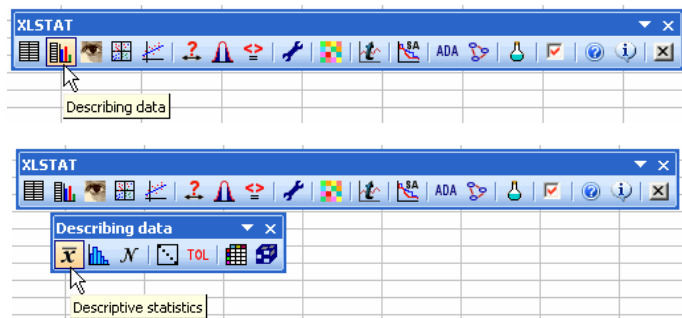

Once you have clicked on the button, the **Descriptive Statistics** dialog box appears.

The data corresponding to the variable "Sepal length" were selected in the **Quantitative data** field. Note that for a box plot, the data must be numerical (quantitative) data.

As the name of the variable was included in the selection, the **Labels included** option was also selected.

The Species data were selected as **subsamples** to enable the comparison between species.

The **Sheet** option was selected because we wanted the results displayed on a new sheet of the workbook.

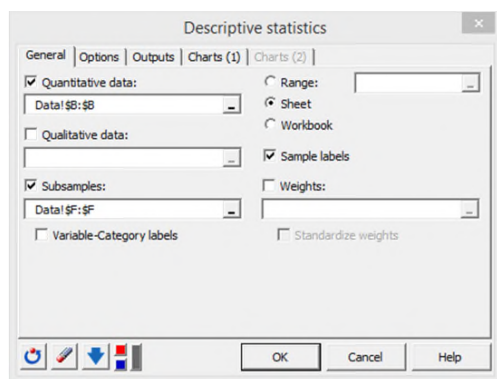

In the **Options** tab, the following options have been activated.

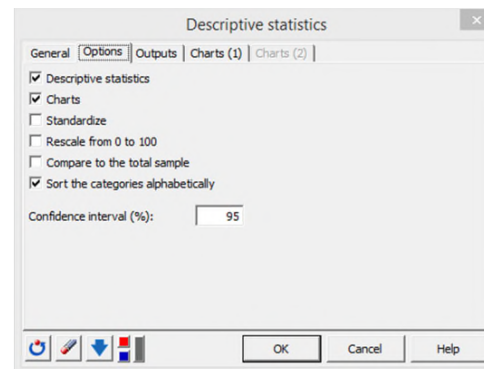

The **Normalize** or **Rescale** options can be used when you want to compare several variables spread over different scales - there is no need to use these in this case as we are dealing with only one variable.

The confidence interval does not play a role in generating boxplots, so we won't pay attention to this option.

In the **Outputs** tab, you can select different descriptive numerical statistics (mean, standard deviation, variance, skewness, kurtosis...) that will be computed for every subsample.

In the **Charts(1)** tab (charts related to quantitative data), and in the **chart types** subtab, check the **box plots** option.

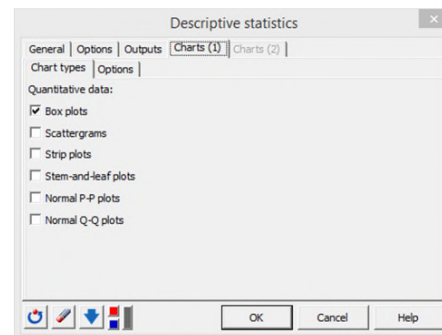

In the **Options** subtab, the **Group plots** option has been chosen so that the box plots are displayed on the same chart, and not separately.

The **Minimum/Maximum** option has been checked so that the minimums and maximums are

presented on the box plots.

Notice that several display options are also available.

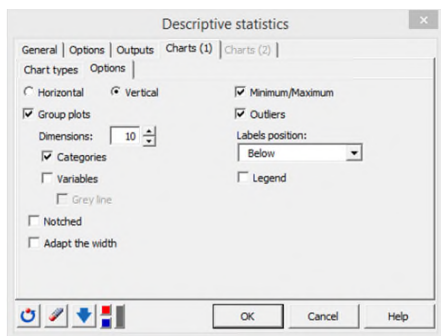

Click on the **OK** button to obtain the results.

Box plot interpretation

The results are displayed on the new sheet named "Desc". They include a full set of descriptive statistics.

Descriptive statistics (Quantitative data):			
Statistic	1	2	3
No. of observations	50	50	50
No. of missing values	0	0	0
Sum of weights	50	50	50
Minimum	43.000	49.000	49.000
Maximum	58.000	70.000	79.000
Freq. of minimum	1	1	1
Freq. of maximum	1	1	1
Range	15.000	21.000	30.000
1st Quartile	48.000	56.000	62.250
Median	50.000	59.000	65.000
3rd Quartile	52.000	63.000	69.000
Sum	2503.000	2968.000	3294.000
Mean	50.060	59.360	65.880
Variance (n)	12.176	26.110	39.626
Variance (n-1)	12.425	26.643	40.434
Standard deviation (n)	3.489	5.110	6.295
Standard deviation (n-1)	3.525	5.162	6.359
Variation coefficient	0.070	0.086	0.096
Skewness (Pearson)	0.116	0.102	0.114
Skewness (Fisher)	0.120	0.105	0.118
Skewness (Bowley)	0.000	0.143	0.185
Kurtosis (Pearson)	-0.346	-0.599	-0.088
Kurtosis (Fisher)	-0.253	-0.533	0.033
Standard error of the mean	0.493	0.723	0.890
Lower bound on mean (95%)	49.068	57.906	64.091
Upper bound on mean (95%)	51.052	60.812	67.669
Mean absolute deviation	2.707	4.214	5.026
Median absolute deviation	2.000	3.500	4.000
Geometric mean	49.938	59.140	65.578
Geometric standard deviation	1.073	1.091	1.102
Harmonic mean	49.817	58.919	65.274

Then, the box plots are displayed.

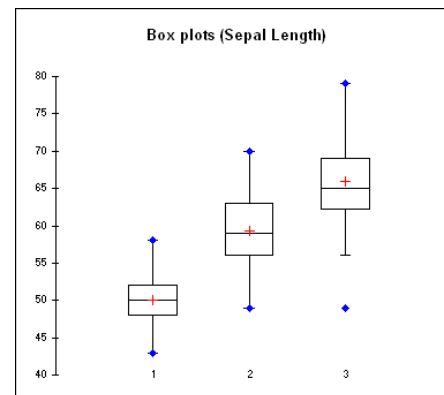

One box plot per species is displayed. The red crosses correspond to the means. The central horizontal bars are the medians. The lower and upper limits of the box are the first and third quartiles, respectively. Points above or below the whiskers' upper and lower bounds may be considered as outliers. Points in blue are minimum and maximum for each species. The box plot's horizontal width has no statistical meaning.

It appears clearly that the Sepal length variable is different (higher) for the third species compared to the first two.

Watch this video to see how to generate this boxplot.

XLSTAT-2: Creating a scatter plot with XLSTAT (2015-10-13)

Dataset to create a scatter plot

An Excel sheet with both the data and the results can be downloaded by clicking here.

The data correspond to a small group of patients that have been on a specific diet. Their doctor has recorded their Weight before the treatment (kg), how much weight they've lost (kg), if they are satisfied or not with the diet effect, and their "Age".

Our goal is here to visualize the results while keeping as much information as possible.

Setting up a scatter plot

Once XLSTAT-Pro is activated, select the **XLSTAT / Visualizing data / Scatter Plot** command, or click on the corresponding button of the **Visualizing Data** toolbar (see below).

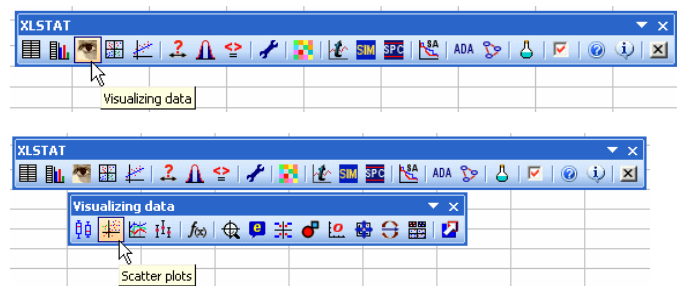

- 41/52 -

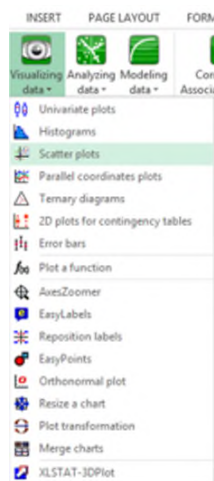

Once you have clicked on the button, the **Scatter Plot** dialog box appears.

In the **General** tab, select the data on the Excel sheet as following:

- X: Weight;
- Y: Weight loss;
- Z: Age;
- Groups: Satisfied.

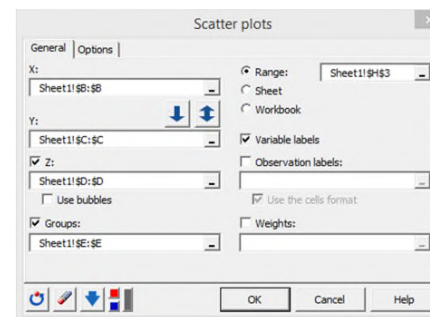

In the **Options** tab, activate the **Frequencies** and **Only if >1** as we want to know if two or more points are superimposed if there is such as case. The **Confidence Ellipses** option can only be activated if the **Z** data option is unactivated in the **General** tab. This tutorial will help you in drawing scatter plots with confidence ellipses in XLSTAT.

Activate the **Legend** option to be able to identify points belonging to each of the two categories of the **Groups** column.

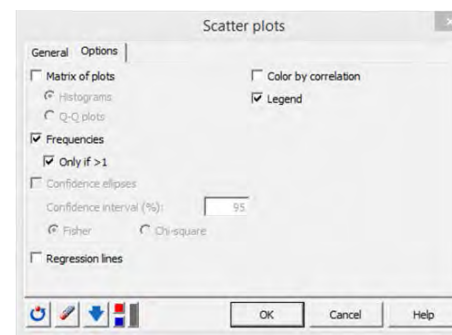

Interpreting a scatter plot

Then, after you have clicked on the **OK** button, a chart is displayed on the sheet starting at H3 (because this cell was selected in the Range option for outputs).

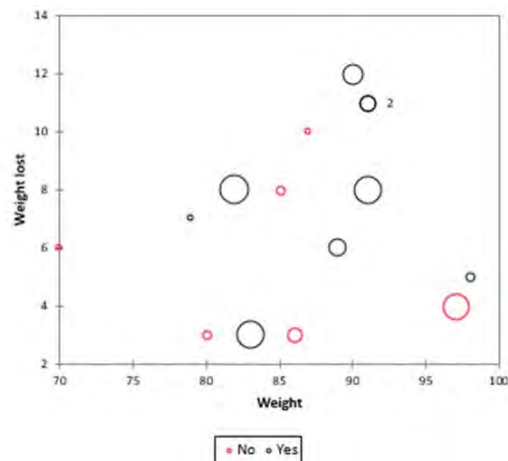

Bubble size is proportional to the Z variable (age in our case) and is thus a way to represent a third dimension on our two-dimensional plot. Here for example, we see that satisfied people are relatively old.

Note 1: for one of the observations a label has been added. This tells us that two observations are surperimposed.

Note 2: the observations labels haven't been used on the chart because the "Observations labels" option was not checked.

Watch the following video to see how the settings are done.

XLSTAT-3: Creating histograms and fitting a distribution with XLSTAT (2015-10-13)

What you will do in this tutorial

First by using the XLSTAT tool allowing to create histograms, and then by using the distribution fitting tool, we want to test if the sample (in a statistical sense) follows a negative binomial distribution or not. Usually, the negative binomial distribution represents well the aggregation/dispersion phenomenon of bacteria in water environments.

Data to create an histogram and fit a distribution

An Excel sheet with both the data and the results can be downloaded by clicking here.

The data correspond to an experiment where 200 samples of water from a river were cultured on medium with nutrients to determine the presence or absence of bacterial contamination with Escherichia coli. The number of colonies has been counted after 72 hours of incubation. In the Bact-Data column you will find the counts for the 200 samples.

Setting up the dialog box to create an histogram

After opening XLSTAT, select the **XLSTAT / Describing data / Histograms** command, or click on the corresponding button of the **Describing data** toolbar (see below).

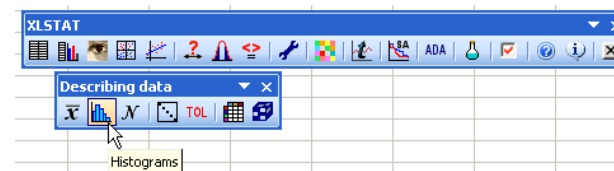

Once you've clicked on the button, the dialog box appears. Select the data on the Excel sheet.

The **Data** are in the B column. We activate the **discrete** option because the counts are discrete values. The **Sample labels** option is left activated because the first row of the data selection contains the name of the sample.

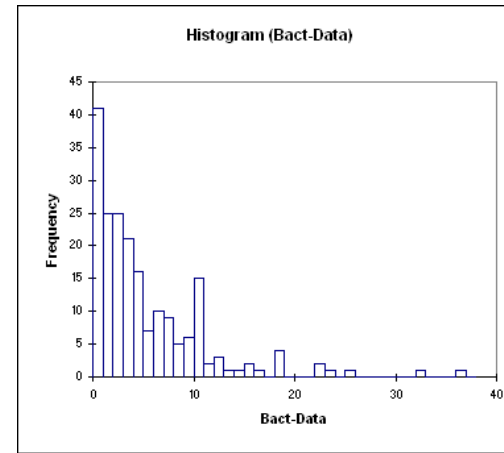
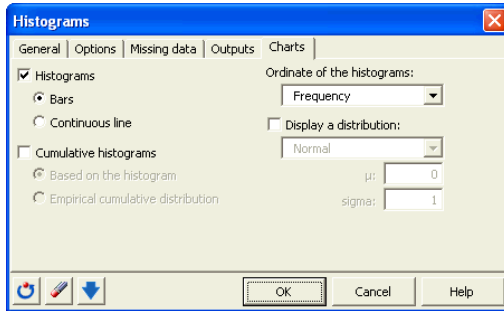
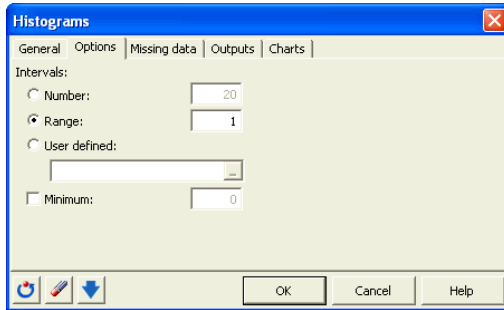
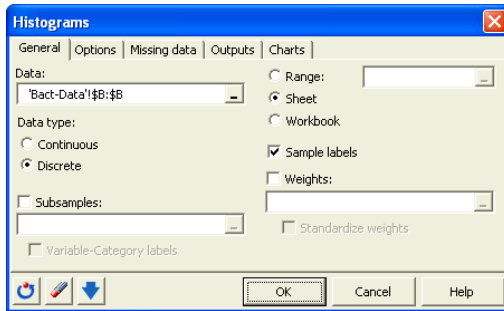

On the histogram we can see that the most frequent value is 0, which represents over 20% of the data. That is, in more than one sample out of five, no bacteria has been found. We also notice that the frequency decreases quickly. In one sample, over 36 colonies have been counted.

The following video shows how to do it.

The computations begin once you have clicked on the **OK** button. The results will then be displayed.

Interpreting a histogram

After some summary statistics, the histogram is displayed on sheet **Histogram**, followed by a table where the statistics of the histogram are available.

XLSTAT-4: Running a Factor analysis with XLSTAT (2015-10-13)

Dataset for running a Factor Analysis

An Excel sheet containing both the data and the results for use in this tutorial can be downloaded by clicking here.

The data are from [Kendall M. (1975). Multivariate analysis. Griffin, London] and correspond to 48 applicants for a position in firm who have been judged on 15 variables:

- Form of letter of application
- Appearance
- Academic ability
- Likeability
- Self-confidence
- Lucidity
- Honesty
- Salesmanship
- Experience Drive
- Ambition Grasp
- Potential Keenness to join
- Suitability

Because many correlations between the variables are high, it was felt that the judge might be confusing some of the variables, or that some variables might be redundant. Therefore a factor analysis was conducted to determine the fewer underlying factors.

Several methods are available for computing factor analysis. XLSTAT default method is the Principal factor method applied iteratively. We will apply it here to generate seven factors, and we will do a varimax rotation to facilitate the interpretation of the results.

Setting up a Factor Analysis

After opening XLSTAT, select the **XLSTAT / Analyzing data / Factor analysis** command, or click on the corresponding button of the **Analyzing data** toolbar (see below).

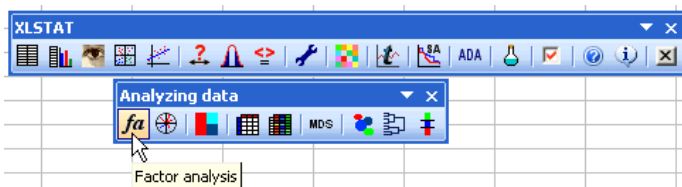

Once you've clicked on the button, the Factor analysis dialog box appears. Select the data on the Excel sheet.

The **Observations labels** are also selected in the corresponding field.

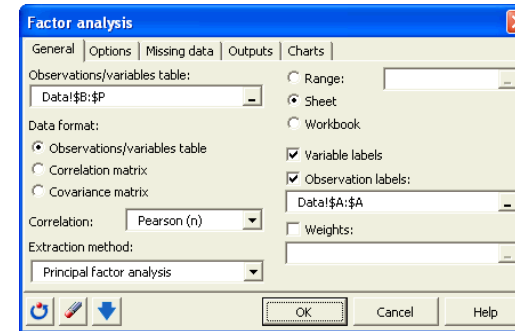

In the **Options** tab we select the **varimax** option for the rotation that will be applied to the first two factors.

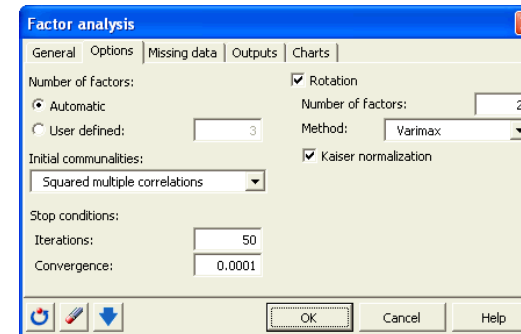

The following options have been activated for the outputs and the charts.

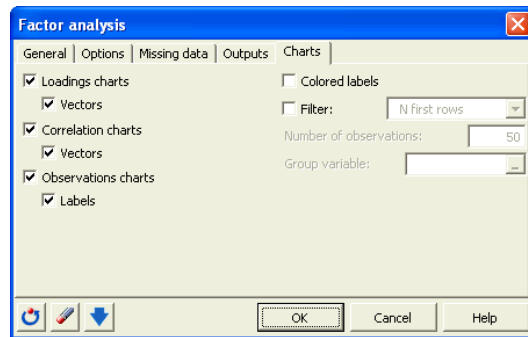
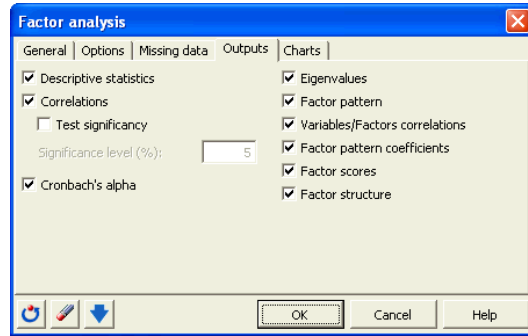

The computations begin once you have clicked on **OK**. The results will then be displayed.

Interpreting the results of a Factor Analysis

The first results that are displayed are the summary statistics of the selected variables, and the correlation matrix between the variables. We can see that some of the correlations are quite high (0.883 for Grasp and Lucidity).

The standardized Cronbach's alpha is computed for the whole input table. An alpha of 0.914 means that there is some redundancy among the selected variables.

The reproduced and residual correlation matrices allow to verify if the factor analysis model is fine or not, and where it fails to reproduce correlations.

The next table shows the eigenvalues resulting from the factor analysis. We can see that with 4 factors we keep 75.5 % of the variability of the initial data.

Eigenvalues:	F1	F2	F3	F4	F5	F6	F7	F8	F9	F10
Eigenvalue	7,325	1,738	1,253	0,859	0,216	0,184	0,119	0,078	0,011	0,003
Variability	48,835	11,587	8,352	5,726	1,440	1,228	0,792	0,520	0,073	0,021
Cumulative	48,835	60,422	68,774	74,500	75,940	77,168	77,960	78,480	78,552	78,574

Note:

the eigenvalues displayed above are those obtained with the principal factors extraction method.

With the principal components analysis we would have obtained the following results:

Eigenvalues:	F1	F2	F3	F4	F5	F6	F7	F8	F9	F10
Eigenvalue	7,514	2,056	1,456	1,198	0,739	0,495	0,351	0,310	0,257	0,185
Variability	50,092	13,709	9,705	7,986	4,928	3,297	2,342	2,066	1,713	1,233
Cumulative	50,092	63,801	73,506	81,492	86,420	89,717	92,059	94,125	95,838	97,071

Next, we can see that the varimax rotation has changed the way each factor explains part of the variance.

The varimax rotation makes the interpretation easier by maximizing the variance of the squared factors loadings by column. For a given factor, high loadings become higher, low loadings become lower, and intermediate loadings become either lower or higher.

Percentage of variance after Varimax rotation:		
	D1	D2
Variability (%)	44,389	16,032
Cumulative %	44,389	60,421

The next results we want to look at, are the factor loadings after the varimax rotation. These results are used to interpret the meaning of the (rotated) factors.

Factor pattern after Varimax rotation:

	D1	D2
Form of letter	0,215	0,640
Appearance	0,515	0,157
Academic abil	0,001	0,292
Likeability	0,636	0,039
Self-confidenc	0,866	-0,055
Lucidity	0,857	0,133
Honesty	0,582	-0,358
Salesmanship	0,840	0,281
Experience	0,080	0,805
Drive	0,767	0,364
Ambition	0,844	0,220
Grasp	0,854	0,291
Potential	0,843	0,356
Keeness to jo	0,719	0,134
Suitability	0,389	0,772

From this table we can see that the first factor is highly positively related to Ambition, Self-confidence, Salesmanship and Lucidity. The second factor is loaded on Form of letter, Experience, and Suitability.

From these results, we can understand that the individuals that have high scores on the first factor are promising salesmen, while for other jobs such as management, individuals with high coordinates on the second and third factors might be more appropriate.

The following chart gives the position of the variables on axes F1 and F2. Other charts mixing other factors can be displayed.

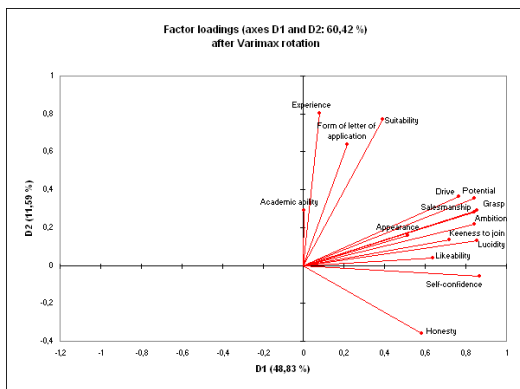

The following table gives the factor scores after the varimax rotation, which are the estimated coordinates of the observations on the factor axes.

Factor scores after Varimax rotation:

	D1	D2
1	0,440	0,164
2	1,068	0,427
3	0,691	0,177
4	-0,147	0,343
5	-0,025	0,829
6	0,110	0,277
7	0,668	1,388
8	0,911	1,310
9	0,464	1,131
10	0,760	0,631
11	0,288	0,723
12	0,779	0,084
13	-0,066	0,246
14	-0,124	0,265
15	-0,528	0,137
16	0,390	0,841
17	0,398	0,362
18	-0,172	-0,458

XLSTAT displays the 2D maps on the selected factors. The chart below represents the map for F1 and F2.

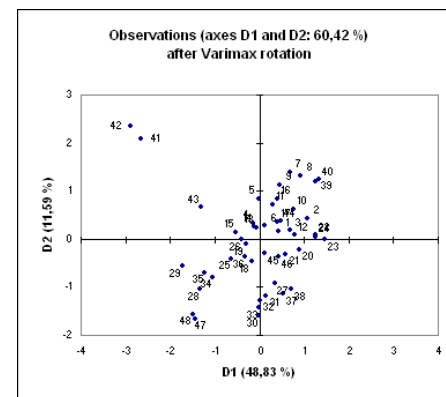

Watch this video to see the demonstration of this tutorial.

Grapher-11-1: Opening an Existing Data File

If you would like to view or edit data, you can open the data file in **Grapher**. There are several ways to view a data file. If a graph has already been created, the most common method to view the data is to use the **Worksheet Manager**. If a graph is not yet created, you can open the data in the worksheet window.

1. Click the **File | Open** command, click the  button on the quick access toolbar, or press CTRL+O on the keyboard. The **Open** dialog displays.
2. If you are not in the Samples folder, browse to it. The Samples directory is located at C:\Program Files\Golden Software\Grapher 11\Samples, by default. In the list of files, click *Tutorial.dat*.
3. Click the *Open* button to display the data in the worksheet window.

Notice that there are several columns of data. Column A contains Month number data. Columns B through I contain site information. Column J contains an abbreviation of month names. Row 1 contains header text, which is helpful for identifying which column contains which data. When a header row exists, the information in the header row is used in the Property Manager when selecting worksheet columns.

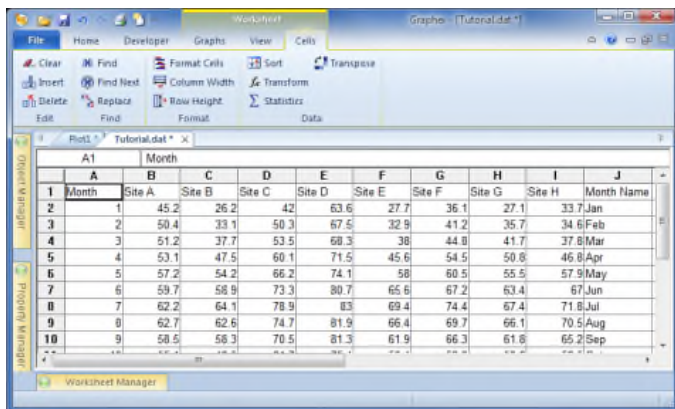

	A1	Month									
1	Month	Site A	Site B	Site C	Site D	Site E	Site F	Site G	Site H	Site I	Month Name
2	1	45.2	26.2	42	63.6	27.7	36.1	27.1	33.7	Jan	
3	2	50.4	33.1	50.3	67.5	32.9	41.2	35.7	34.6	Feb	
4	3	51.2	37.7	53.5	68.3	38	44.8	41.7	37.6	Mar	
5	4	53.1	47.5	60.1	71.5	45.6	54.5	50.8	46.8	Apr	
6	5	57.2	54.2	66.2	74.1	58	80.5	55.5	57.9	May	
7	6	59.7	58.9	73.3	80.7	65.6	67.2	63.4	67	Jun	
8	7	62.2	64.1	78.9	83	69.4	74.4	67.4	71.8	Jul	
9	8	62.7	62.6	74.7	81.9	66.4	69.7	66.1	70.5	Aug	
10	9	58.5	58.3	70.5	81.3	61.9	66.3	61.8	65.2	Sep	

Grapher-11-2: Creating a Graph

You can create graphs in several ways in **Grapher**. Graphs can be created from the **Graphs** tab, with the **graph wizard**, from the **worksheet**, and from **templates**. All of these methods are discussed in the **Creating Graphs** topic. In the tutorial, we use the most common method, creating a graph through the **Graphs** tab **Create** group. We will create a line/scatter plot from an existing data set.

To create a line plot graph:

1. If the worksheet window is still open, click the *Plot1* tab. Alternatively, you can create a new plot window by clicking the **File | New | Plot** command.

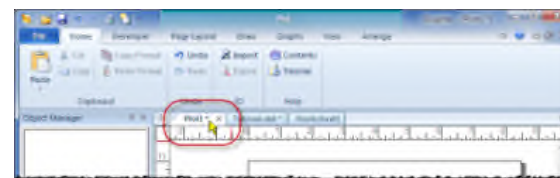

Click on the Plot1 tab to select the existing plot window.

2. Click the **Graphs | Create | Basic | Line Plot** command.
3. In the **Open Worksheet** dialog, select the *Tutorial.dat* samples file, from the Samples directory. You can select the file in the file list section or in the *Open worksheets* section at the bottom of the dialog.
4. Once the file is selected, click the *Open* button.

A line plot is created using the default properties. By default, **Grapher** uses the first two columns containing numeric or date/time data in the data file. With this data file, the X Axis is equal to column A and the Y Axis is equal to column B.

By default, the line plot is selected after the graph is created. The selected plot appears with a bounding box around the outside and selection handles on the line.

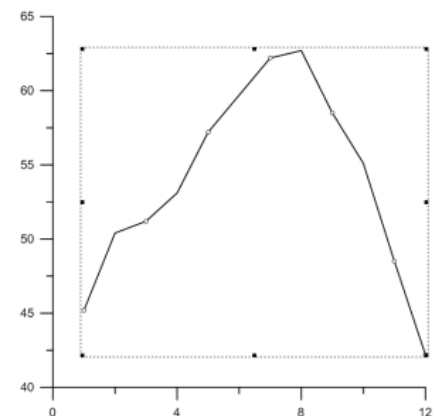

Grapher-11-3: Creating a Graph

Line, Scatter, and Line/Scatter Plots

The **Graphs | Create | Basic | Line Plot, Graphs |**

Create | Basic | Scatter Plot, and Graphs | Create |

Basic | Line/Scatter Plot commands create a line, scatter,

or line and scatter plot from a data file. The data is

displayed as a line, as symbols, or as a combination of a

line and symbols. The data are plotted in the order in

which they appear in the data file. You can have multiple

line/scatter plots in a graph. In addition, the plots can

contain fit curves, error bars, labels, and color fill. You

can also clip the curves.



Click the Line Plot, Scatter Plot, or

Line/Scatter Plot buttons to create the

desired plot type.

Line/Scatter plots show data as lines, lines and symbols, or only symbols. This graph has three plots: a

pink line only plot, a green symbol only plot, and a blue line and symbol plot.

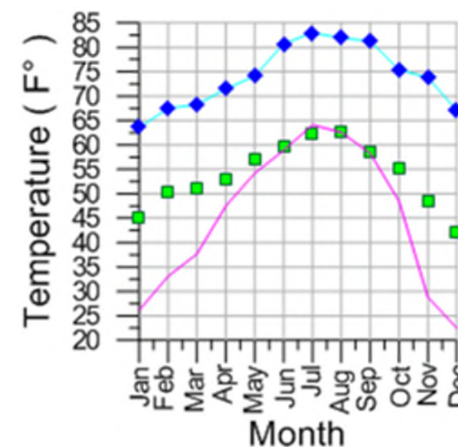

Creating a New Line, Scatter, or Line/Scatter Plot

To create a new line, scatter, or line/scatter graph:

1. Click the **Graphs | Create | Basic | Line Plot, Graphs | Create | Basic | Scatter Plot, or Graphs | Create | Basic | Line/Scatter Plot** command.
2. Select a data file in the **Open Worksheet** dialog. You can select a new data file or you can select an open data file in the *Open worksheets* section.
3. Click the *Open* button. A line, scatter, or line/scatter plot is created using the default properties.

Editing an Existing Line, Scatter, or Line/Scatter Plot

To change the features of a line, scatter, or line/scatter plot, click once on the plot in either the plot

window or the Object Manager to select it. The properties of the selected line/scatter plot are

displayed in the Property Manager.

The line plot is created with the default settings and should look similar to this graph.

ArcGIS 10.2.2-1 Create X-Y plots

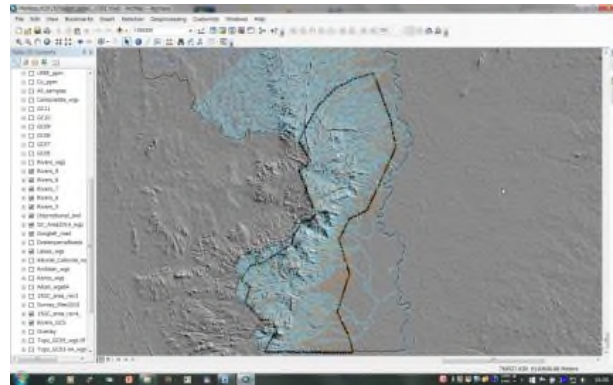

1: Prepare area to analyze (e.g. GC11).

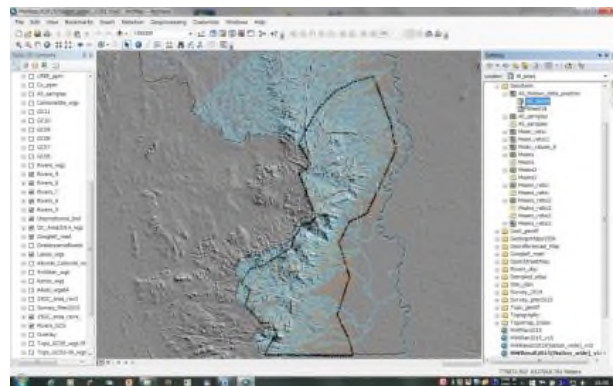

2: Show the right sided catalogue window. Select coordinate including Excel spread sheet (e.g. XY data),

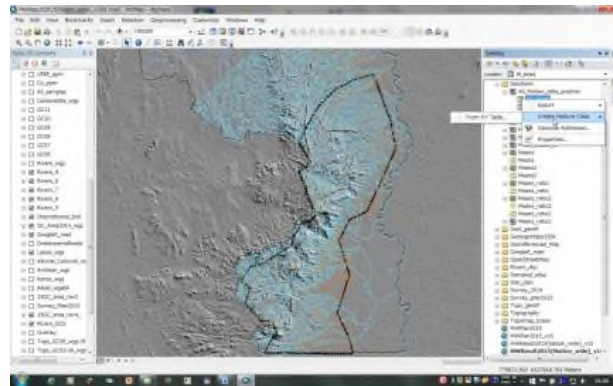

3: after selecting XY data and sheet, click 'Create Feature Class', then select 'From XY Table'.

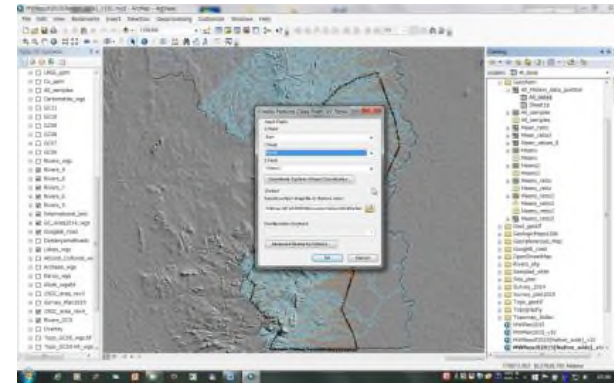

4: Here show the new box centered 'Create Feature Class From XY Table', and in followed column fit X field by 'East' and Y field by 'North'.

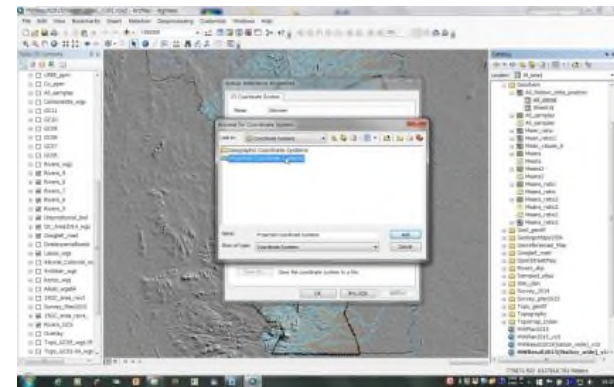

5: Click button of 'Coordinate System of Input Coordinate', then select 'Projected Coordinate System'.

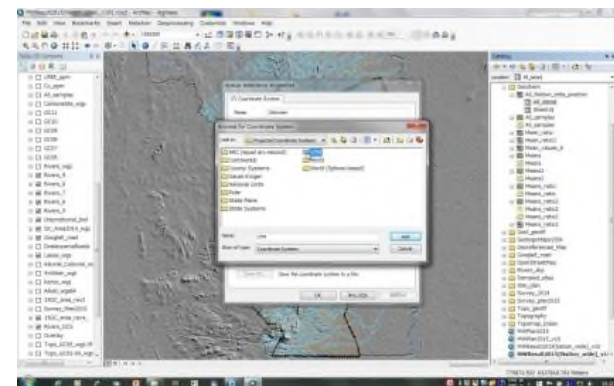

6: Then select 'UTM',

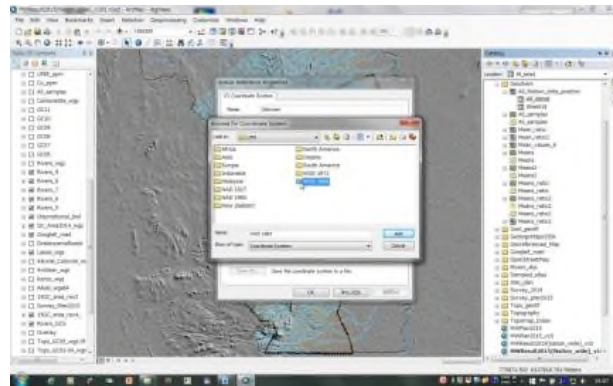

7: and WGS 1984,

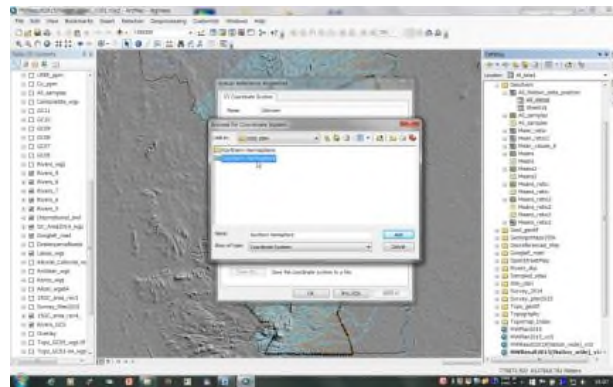

8: and Southern Hemisphere,

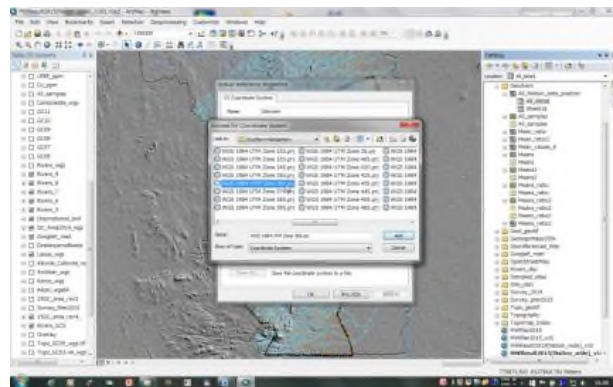

9: and WGS 1984 UTM Zone 36S. It's Malawi.

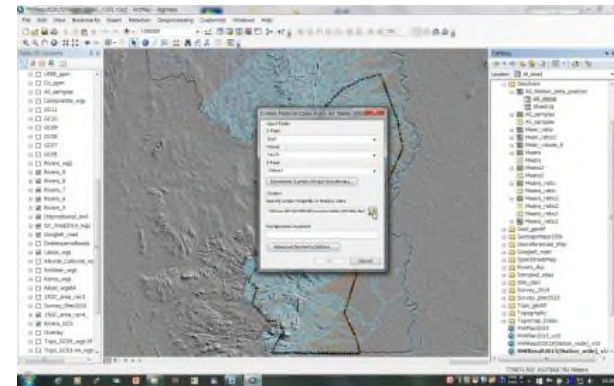

10: Then click Output lay at right sided folder,

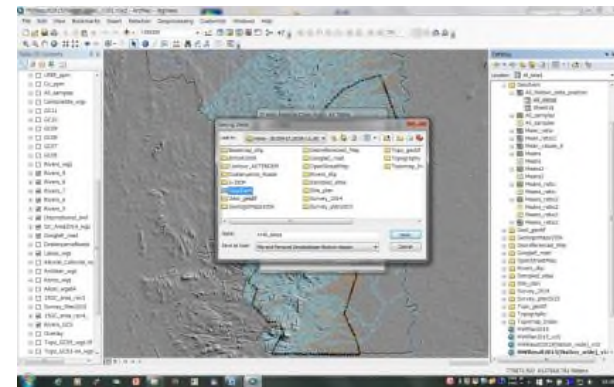

11: and select the preferable folder to load the newly create file in 'Home',

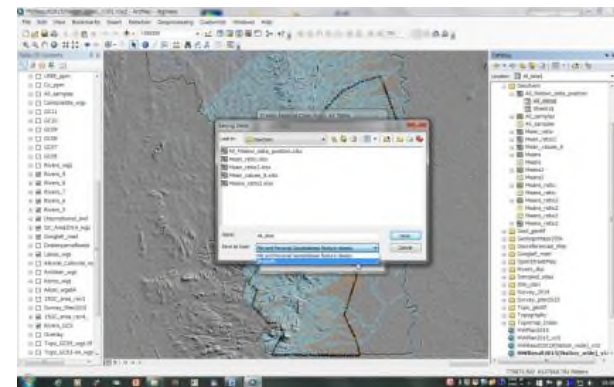

12: and Rename (here XY data) and 'Select as type' click shapefile.

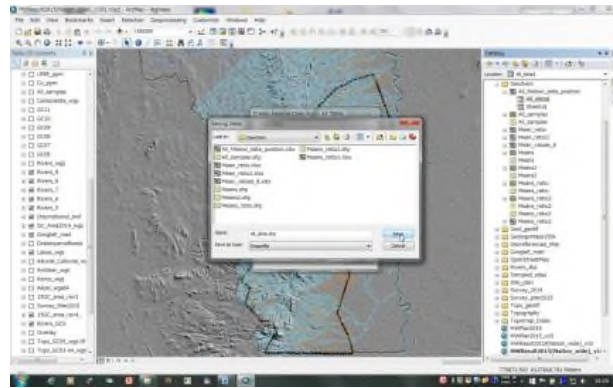

13: Then save it.

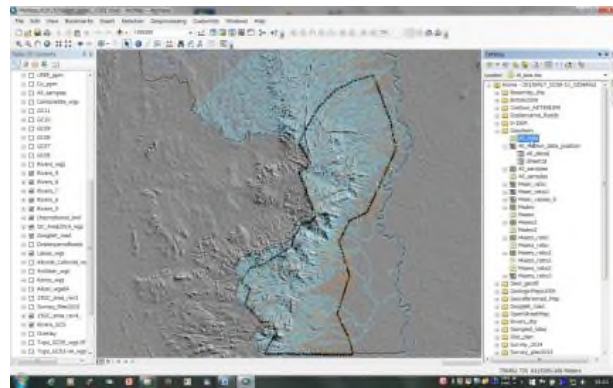

14: Now, Drag and Paste the newly created 'All_data shape file' into center display.

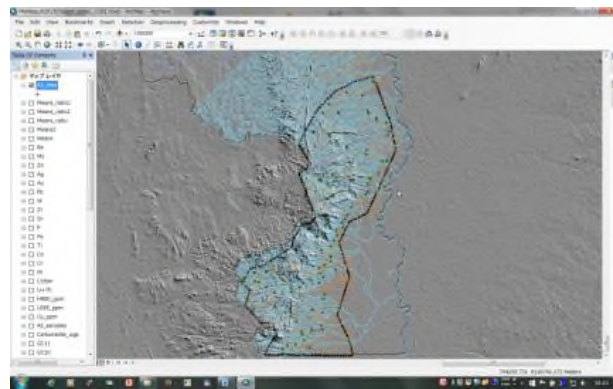

15: Here shows the newly created 'All_data shape file' by default point symbology (green), and also confirmable it in left sided 'Table of Contents' window.

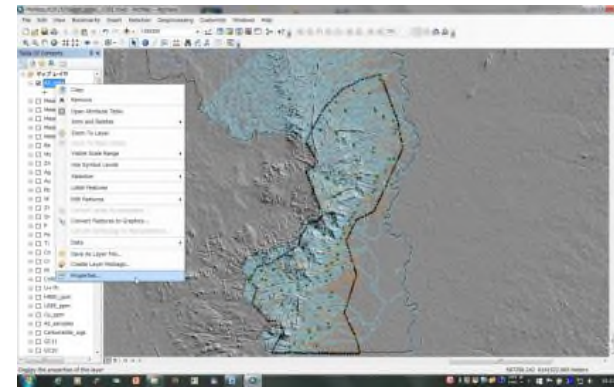

16: Now, at left sided 'Table of Contents' window, select 'Properties' of newly created 'All_data shape file',

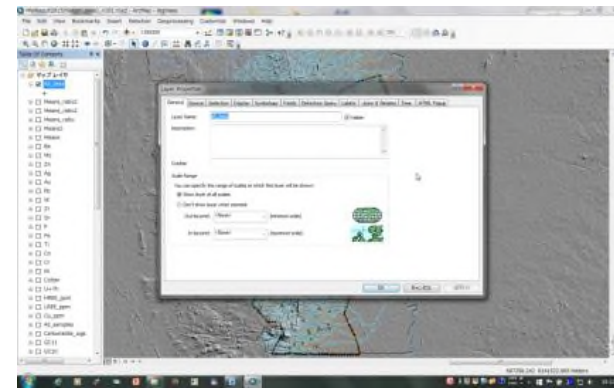

16: then shows a 'Layer Properties' box in the center,

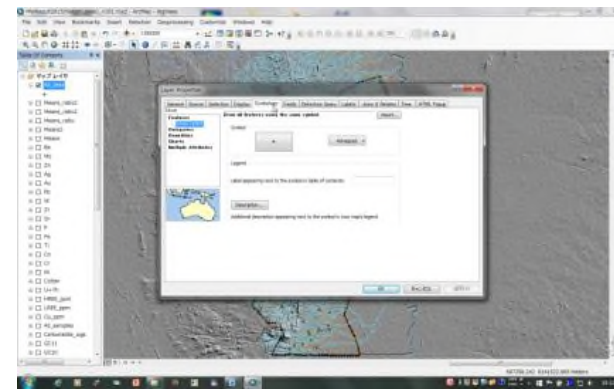

18: and select 'Symbology',

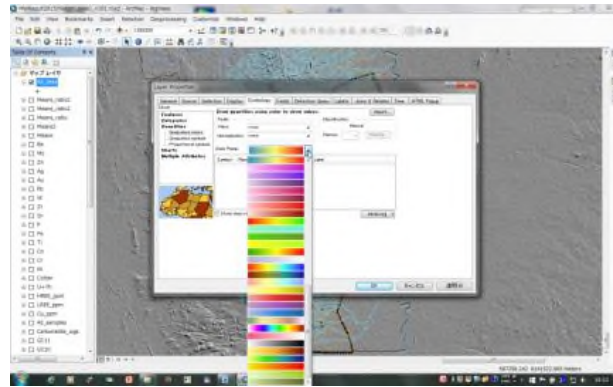

19: and select graduated symbols in left column, and choose 'Color Ramp' of Green-Red graduation,

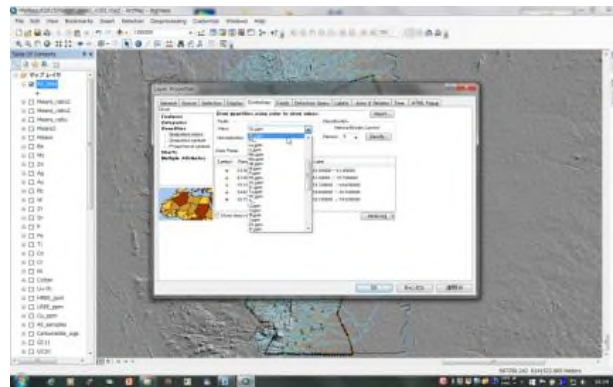

20: and select 'Value' box to select 'Cu_ppm' to show, and default 5 categories, followed automatically categorized 5 ranges,

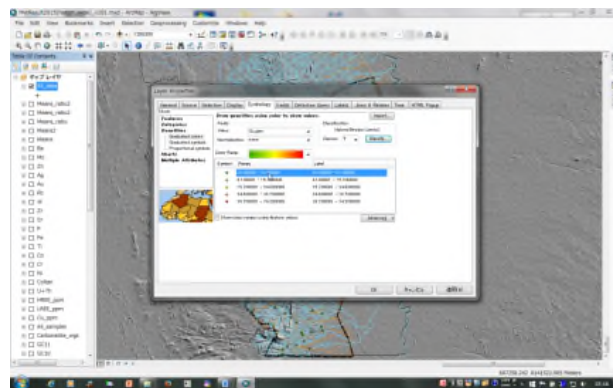

21: then, select 'Range' to arrange to adequate value classification ranges, which were established by threshold determination process from background value to positive anomaly value, and symbol expression

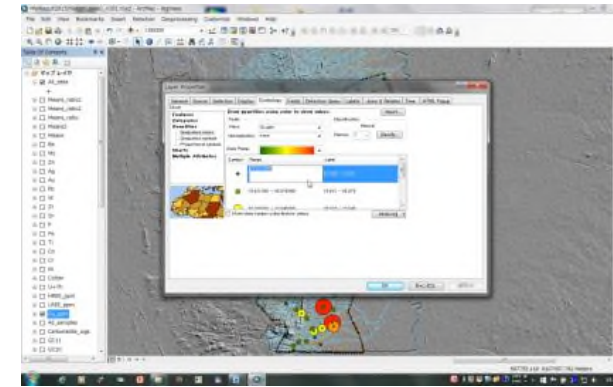

22: you can arrange also label expression (max. digit under decimal point etc.) for legend or labels combined with symbol,

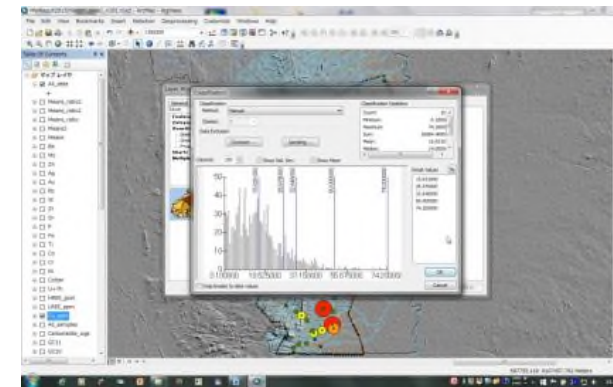

23: you can check also the arranged classification range from classification button by histogram style,

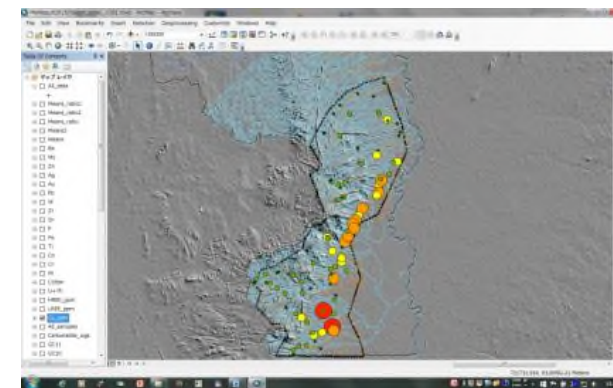

24: Here shows the bubble plots required. Now only remain some label arrangement by same layer property box.



Geological Survey Department
/ MNREM, Malawi



Japan International
Cooperation Agency

Project on Capacity Building in Mining Sector in Malawi

Handheld XRF (Niton™ XL3t 950 GOLD D+)

Maintenance Manual

Version 1.0



February - 2016

Joint Venture

Sumiko Resources Exploration and Development Co., Ltd. (SRED)

Mitsubishi Materials Techno Corporation (MMTEC)

Contents

Introduction1

1. Tips and trouble-shooting 2

2. Reference samples 16

3. XRF check list 24

3. References 24

Appendix 3-7

Introduction

Handheld XRF (Thermo Scientific Niton XL3t and Ultra X-Ray Fluorescence [XRF] Analyzers, hereafter call only handheld XRF) is an established high-spec geochemical analysis tool in case of fieldwork and laboratory work for mining exploration purpose. In this project two handheld XRF (S/N 92641, 92727) have been donated to GSD-HQ (Zomba) with the Mobile Test Stand (safety housing for small amount sample analysis) and training short course (October-2014).

These XRF analyzers provide the warranty period (24 months, up to October-2016), so that usual repairs are done free of charge as far as in normal usage with in the period. However ordinary maintenance management also should be done to be enabling long term use as well as other laboratory apparatus.

Here in this manual shows; 1) ordinary maintenance and trouble-shooting procedure to keep original state of the XRF analysis reliability, 2) some reference samples for standardization of analysis elements, and 3) proposal of maintenance management record format for XRF. Most materials are referred from “Thermo Fisher Scientific Niton Analyzers XL3 Analyzer Version 7.0.1 User’s Guide-Revision C, November 2010”, which is received from South Africa Division (Figure-A).



Figure A: Thermo Fisher Scientific, Niton Analyzers XL3 Analyzer Version 7.0.1 User’s Guide
Revision C, November 2010

1. Tips and trouble-shooting

To maintain the XRF, it is better to be done a periodical check of the “Spec window” to know the current state of your XRF instantly, such as serial number, date and time, battery state, system check reminder and so on as shown in next page.

And also, to ensure the reliability, durability, and performance of your XRF, keeps it clean-especially the transparent measurement window covering the analysis window. Clean the measurement window gently with a cotton swab. Clean the body of the analyzer with a soft cloth. Never use detergents or solvents on your analyzer, or immerse your analyzer in water. If the measurement window becomes frayed, ripped, or contaminated with metal particulates, replace it with a new window. Measurement windows (Standard Window Niton P/N 187-1555 or Helium Purge Window Niton P/N 187-1454) may be ordered from Thermo Fisher Scientific’s Service Department in your local Authorized Niton Analyzers Service Center. From time to time, your touch screen will need cleaning. Niton recommends that you use a lens cleaning solution with a soft cloth. Do not use water to clean your Niton Analyzer.

To keep above mentioned measurement window clean in case of in situ or grab sample measurement, it is recommendable use one transparent plastic bag between sample and XRF (see Figure-B).



Figure-B: Plastic bag usage between sample and XRF

18 Learning More, Service, and Support
Tips and Troubleshooting

Tips and Troubleshooting

The Specs Screen

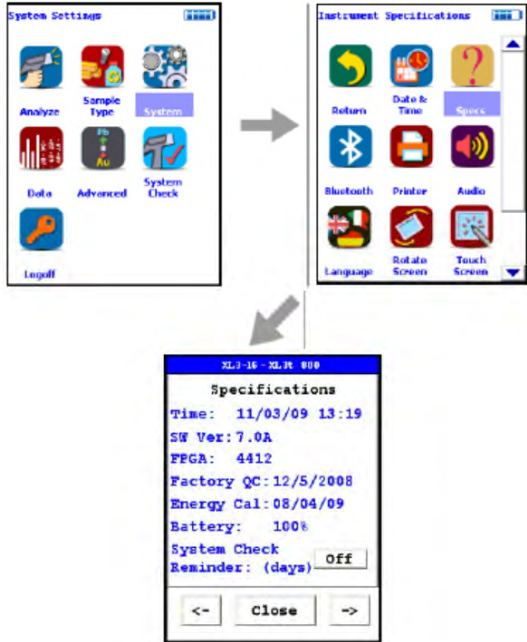

Figure 1. The Specs Screen Menu Path

476 Niton XL3 Analyzer User's Guide Thermo Scientific

18 Learning More, Service, and Support
Tips and Troubleshooting

Select the Specs icon from the System Menu to display the analyzer's specifications. These specifications include your analyzer's serial number, software and firmware versions, and other data. Press the Close Screen Button to return to the previous menu. Press the ">" Screen Button to go to the Diagnostic Menu, and press the "<" Screen Button to return to the Specifications Screen.



Figure 2. The Specifications Screen

On the Specs Screen, standard information on the state of your analyzer is shown for your reference. This information should be reported to Service if there is a problem.

Specs Information

The following is the information supplied on the Specs Screen:

Instrument Specific Serial Number

This is located in the left part of the blue band at the top of the screen.

Model Number

This is located in the right part of the blue band at the top of the screen.

Date And Time

This is the current Date and Time. This is particularly important for date stamping.

SW Version

This is the currently loaded software version, which should be reported to Service if there is any problem.

Thermo Scientific Niton XL3 Analyzer User's Guide 477

18 Learning More, Service, and Support Tips and Troubleshooting

FPGA
This is the currently loaded FPGA software version, which should be reported to Service if there is any problem. FPGA versions are always a four digit number. Any other number of digits may be a sign of a problem in the FPGA code.

Factory QC
This is the date that the machine was QCed at the factory.

Energy Cal
This line notes the last time a System Check was performed.

Battery
This line gives the proportional charge remaining to the battery.

System Check Reminder
Select the OFF Screen Button after "System Check Reminder" to set a reminder to calibrate your analyzer. Selecting the button will open the Cal. Reminder Editor. Select the number of days you want between reminders with the numeric keys. Of the other screen buttons, C = Clear All, E = Enter, and OFF shuts off the Reminder Function. Selecting the E button will enter the current value as the reminder interval and return to the Specs Screen.

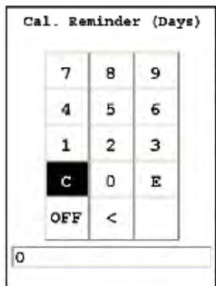

Figure 3. Cal Reminder Editor Screen

478 Niton XL3 Analyzer User's Guide Thermo Scientific

18 Learning More, Service, and Support Tips and Troubleshooting

Diagnostics
Select the ">" Screen Button to load the Diagnostics Screen. The Diagnostics Screen shows Detector Temperature, Bias, Cooler Voltage, SubBias, Energy Scale, and Temperature in C and F scales.
The Diagnostics Screen can be of great utility in assuring proper operation of your analyzer.

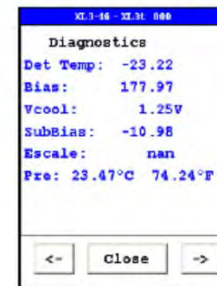

Figure 4. The Diagnostics Screen
The proper ranges of operational values on the Diagnostics Screen follow.

Det Temp:
Detector Temperature should be within this range:
- 25 + or - 5 degrees

Bias:
Bias should be within this range:
175 + or - 10

VCool:
VCool will vary with the ambient temperature.

Thermo Scientific Niton XL3 Analyzer User's Guide 479

18 Learning More, Service, and Support
Tips and Troubleshooting

SubBias: SubBias should be within this range:
-11 + or - 3

Escale: Escale should be within this range:
6.6 through 9.0

Preamp: Preamp value should only be noted, and reported to Service if there is a problem.

Error Messages
The analyzer will auto-detect many perceived hardware problems and may display the following error messages:

480 Niton XL3 Analyzer User's Guide Thermo Scientific

- 5/13 -

18 Learning More, Service, and Support
Tips and Troubleshooting

Figure 5. The Specs Screen Menu Path
Please re-run the [System Check](#) and if the problem persists, contact [customer service](#).

Thermo Scientific Niton XL3 Analyzer User's Guide 481

Appendix 3-7

18 Learning More, Service, and Support
Registration and Licensing FAQ

Registration and Licensing FAQ

Niton XL3t and XL3t GOLDD

As a user of a Niton XL3t analyzer, you may be required to register or obtain a license with your local radiation control authority. In the US, if you intend to do work with your analyzer in states other than your own, you may be required to register there as well. Below is a list of commonly asked questions that come up when filling out registration forms.

FAQ

Q: What is the max mA, max kVp, and max power?
A: Maximum mA is 0.1 mA
Maximum kVp is 50 kVp
Maximum power: 2 watts

Q: What is the accelerator voltage or MeV?
A: This should be filled out as not applicable N/A as it does not apply to Niton XL3t analyzers.

Q: What is the radioisotope?
A: There are no radioactive isotopes in Niton XL3t analyzers.

Q: What category is the Niton XL3t?
A: States differ greatly in their categories; the following is a list of common categories:

- X-Ray Fluorescence
- Analytical or Analytical XRF
- Open Beam or Open Beam Analytical
- Portable Gauge or Portable XRF
- Industrial Analytical or Non-Destructive Testing

When selecting the category make sure that you don't select medical or radiographic.

482 Niton XL3 Analyzer User's Guide Thermo Scientific

18 Learning More, Service, and Support
Registration and Licensing FAQ

Q: How many tubes are in the Niton XL3t?
A: One.

Q: What is the analyzer serial number?
A: The serial number is a 5 digit number located on the yellow sticker on the underside of your analyzer.

Q: What is the tube serial number?
A: The serial number of the tube can be found on the Calibration Certificate.

Q: What is the type of X-Ray Processing?
A: None. Niton XL3t analyzers do not use film.

Q: How often do I need to perform leak tests on the Niton XL3t?
A: Never. Leak tests are only required for analyzers with radioactive isotopes. Niton XL3t analyzers do not have radioactive isotopes.

Niton XL3p

Routine Maintenance Guidelines

Maintenance, Cleaning and Repairs

To ensure the reliability, durability, and performance of your Niton Analyzer, keep it clean—especially the transparent measurement window covering the analysis window. Clean the measurement window gently with a cotton swab. Clean the body of the analyzer with a soft cloth. Never use detergents, or solvents on your analyzer, or immerse your analyzer in water. If the measurement window becomes frayed, ripped, or contaminated with metal particulates, replace it with a new window. measurement windows (Standard Window Niton P/N 187-1555 or Helium Purge Window Niton P/N 187-1454) may be ordered from Thermo Fisher Scientific's Service Department in the United States, toll free, at (800) 875-1578, or outside the United States, at +1-978-670-7460 or from your local Authorized Niton Analyzers Service Center.

Thermo Scientific Niton XL3 Analyzer User's Guide 483

18 Learning More, Service, and Support
Registration and Licensing FAQ

From time to time, your touch screen will need cleaning. Niton recommends that you use a lens cleaning solution with a soft cloth. Do not use water to clean your Niton Analyzer.

WARNING All Service, except exterior cleaning and measurement window replacement, must be performed by Thermo Scientific or an Authorized Niton Analyzers Service Center. Do not attempt to make repairs yourself. Opening the case of your Niton will void the analyzer Warranty in its entirety.

CAUTION Always obtain a Return Authorization (RA) number from Thermo Fisher Scientific's Service Department in the United States, toll free, at (800) 875-1578, or outside the United States, at +1-978-670-7460 before returning your analyzer to the Niton Service Department or local Authorized Niton Analyzers Service Center.

Replacing the Measurement Window

1. Remove the two Phillips head screws.



Figure 6. View of Face Plate and measurement window

2. Remove the face plate and place it face down.

484 Niton XL3 Analyzer User's Guide Thermo Scientific

- 7/13 -

18 Learning More, Service, and Support
Registration and Licensing FAQ



Figure 7. Face Plate Removed showing measurement window on Reverse

3. Remove the old measurement window.
4. Clean the back surface of the face plate and install the new Window.
5. Turn the face plate over and replace it on the analyzer's front end, fitting the plate carefully over the Proximity Button



Figure 8. Fitting Face Plate over Proximity Button

Thermo Scientific Niton XL3 Analyzer User's Guide 485

Appendix 3-7

18 Learning More, Service, and Support
Storing and Transporting Your Niton XL3 Analyzer

6. Reinstall the two screws, being careful not to over-tighten them.



Figure 9. Replacing the Screws.

Storing and Transporting Your Niton XL3 Analyzer

All Niton Analyzers are transported in waterproof, drop-resistant, fully padded carrying cases with padlocks. In most countries, Niton XRF analyzers may be transported by car or plane or shipped as an *ordinary* package. For most courier services, no special labels are required on the outside of the Niton analyzer case or on additional packaging.

486 Niton XL3 Analyzer User's Guide Thermo Scientific

18 Learning More, Service, and Support
Storing and Transporting Your Niton XL3 Analyzer



Figure 10. The Niton Carrying Case

All padlocks are shipped with a default combination of "0-0-0". If you change this combination, please inform Thermo of the new combination if you return the unit for service.

To change the combination:

1. Dial the default combination to open the lock, and pull out the shackle.
2. Rotate the shackle 180 degrees and push it down as far as it can go.
3. While holding the shackle down, rotate it 90 degrees back in either direction and release shackle.
4. Change the dial settings to the desired combination, record the combination, and without disturbing the dials, rotate the shackle back 90 degrees to the position it had in step 2.
5. Pull shackle out and rotate it 180 degrees and secure it. Your lock now has its own secret combination.

CAUTION Always transport the unit in its padded carrying case, and store the Niton Analyzer in its case whenever it is not being used.

Thermo Scientific Niton XL3 Analyzer User's Guide 487

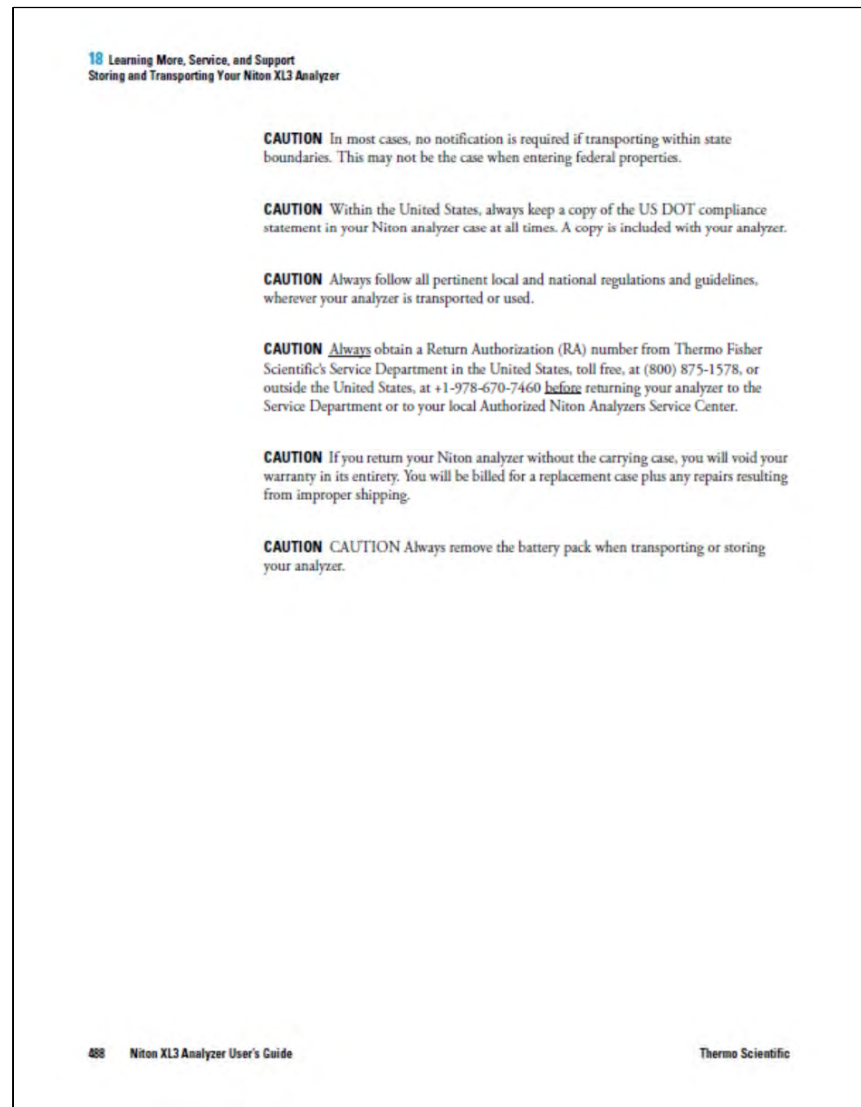

- 9/13 -

2. Reference Samples

Quality control (QC) and quality assurance (QA) are the key issues of handheld XRF as well as all other field-use analyzers, particularly to compare the obtained data with another type analysis. To keep the consistency of analysis results in long term geochemical survey, it is recommendable to provide some reference samples in order to adjust respective survey purpose. The XRF maker prepared adequate reference samples, as follows;

Appendix 3-7

Reference Samples

Metal Alloy Reference (Standard) Sample Care



Figure 1. The Metals QC Reference Sample

Metal QC Reference Sample

One or more metal standard(s) are supplied with your instrument if there is an alloy calibration activated on it. This standard should be analyzed on a daily basis and the values obtained checked against the supplied certificate of analysis. For quality assurance purposes, you may also wish to keep a running chart of the values obtained and monitor it for consistency.

If one (or more) of the elements begins to change in terms of reported concentration outside of the normal expected variability, the sample may have become contaminated. This contamination can occur for multiple reasons, for example, oils and salts may transfer from hand contact onto the surface, dust or lint from the surroundings may be deposited onto the sample, or oxidation of the surface may simply occur. If this happens, the sample will need to be cleaned to provide the XRF instrumentation with a clean surface for analysis.

This may be achieved using clean, lint free paper, 2-propanol (isopropyl alcohol, IPA, (CH₃)₂CHOH) and 360 grit diamond grinding paper (179-1203). Do not use rubbing alcohol as this may contain oils and other contaminants. Place the sample on a clean flat surface with the analytical side facing up. Moisten the surface with the alcohol and wipe away any surface debris or contamination. Take a square (approximately 2.5cm or 1 inch) of the diamond paper, and with the rough side against

17 Reference Samples

the sample gently polish the surface to remove oxidation. Dispose of the grinding paper and clean the surface with lint free paper moistened with alcohol until the paper shows no additional residue being removed from the surface. Allow the surface to dry before analyzing.

Soil and Mining Reference (Standard) Sample Care



Figure 2. The Soil/Mining QC Reference Sample Set

Soil/Mining QC Reference Sample

One or more cupped standards are supplied with your instrument if there is a soil or mining calibration activated on it. These standards should be analyzed on a daily basis and the values obtained checked against the supplied certificate of analysis. For quality assurance purposes, you may wish to keep a running chart of the values obtained and monitor them for consistency.

If one (or more) of the elements begins to change in terms of reported concentration outside of the normal expected variability, the sample may have become damaged or contaminated. This may occur for a number of reasons, for example, oils and salts may transfer from hand contact onto the surface, dust or lint from the surroundings may be deposited onto the sample, or the thin film on the front of the cup may have pinholes or have been torn. If the cup film has torn or been damaged in any other way, it should be replaced immediately, this will prevent loss of the material and prevent contamination of the instrument and other samples. If you suspect that the film has been torn, also check the front window of the instrument and clean or replace that too if necessary.

Plastic Reference (Standard) Sample Care



Figure 3. The Plastic QC Reference Sample

Plastic QC Reference Sample

One or more plastic standards are supplied with your instrument if there is a plastic calibration activated on it. These standards should be analyzed on a daily basis and the values obtained checked against the supplied certificate of analysis. For quality assurance purposes, you may wish to keep a running chart of the values obtained and monitor them for consistency.

If one (or more) of the elements begins to change in terms of reported concentration outside of the normal expected variability, the sample may have become contaminated. This contamination can occur for multiple reasons, for example, oils and salts may transfer from hand contact onto the surface, and dust or lint from the surroundings may be deposited onto the sample. If this happens, the sample will need to be cleaned to provide the XRF instrumentation with a clean surface for analysis.

This may be achieved using clean, lint free paper and 2-propanol (isopropyl alcohol, IPA, (CH₃)₂CHOH). Do not use rubbing alcohol as this may contain oils and other contaminants. Place the sample on a clean flat surface with the analytical side facing up. Moisten the surface with the alcohol and wipe away any surface debris or contamination. Moisten a lint free cloth with alcohol and rub harder to remove any imbedded materials. Dry the clean surface with lint free paper moistened with alcohol until the paper shows no additional residue being removed from the surface. Allow the surface to dry before analyzing.

Electronics Metals Reference (Standard) Sample Care



Figure 4. The Electronics Metals QC Reference Sample

Electronics Metals QC Reference Sample

One or more Electronics Metals standard(s) are supplied with your instrument if there is an Electronics Metals calibration activated on it. This standard should be analyzed on a daily basis and the values obtained checked against the supplied certificate of analysis. For quality assurance purposes, you may also wish to keep a running chart of the values obtained and monitor it for consistency.

If one (or more) of the elements begins to change in terms of reported concentration outside of the normal expected variability, the sample may have become contaminated. This contamination can occur for multiple reasons, for example, oils and salts may transfer from hand contact onto the surface, dust or lint from the surroundings may be deposited onto the sample, or oxidation of the surface may simply occur. If this happens, the sample will need to be cleaned to provide the XRF instrumentation with a clean surface for analysis.

This may be achieved using clean, lint free paper, 2-propanol (isopropyl alcohol, IPA, (CH₃)₂CHOH) and 360 grit diamond grinding paper (179-1203). Do not use rubbing alcohol as this may contain oils and other contaminants. Place the sample on a clean flat surface with the analytical side facing up. Moisten the surface with the alcohol and wipe away any surface debris or contamination. Take a square (approximately 2.5cm or 1 inch) of the

17
Lead Paint Reference (Standard) Sample Care

diamond paper, and with the rough side against the sample gently polish the surface to remove oxidation. Dispose of the grinding paper and clean the surface with lint free paper moistened with alcohol until the paper shows no additional residue being removed from the surface. Allow the surface to dry before analyzing.

Lead Paint Reference (Standard) Sample Care

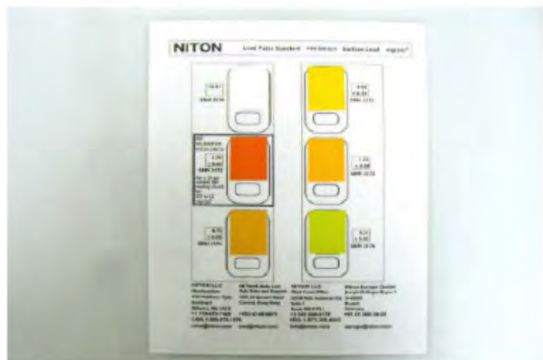

Figure 5. The Lead Paint QC Reference Sample

Lead Paint QC Metals Sample

One or more Lead Paint standard(s) are supplied with your instrument if there is a Lead Paint calibration activated on it. This standard should be analyzed on a daily basis and the values obtained checked against the supplied certificate of analysis. For quality assurance purposes, you may also wish to keep a running chart of the values obtained and monitor it for consistency.

If one (or more) of the elements begins to change in terms of reported concentration outside of the normal expected variability, the sample may have become contaminated. This contamination can occur for multiple reasons, for example, oils and salts may transfer from hand contact onto the surface, dust or lint from the surroundings may be deposited onto the sample, or oxidation of the surface may simply occur. If this happens, the sample will need to be cleaned to provide the XRF instrumentation with a clean surface for analysis.

17
Small Spot Reference (Standard) Sample Care

This may be achieved using clean, lint free paper and 2-propanol (isopropyl alcohol, IPA, (CH₃)₂CHOH). Do not use rubbing alcohol as this may contain oils and other contaminants. Place the sample on a clean flat surface. Moisten the surface with the alcohol and wipe away any surface debris or contamination. Clean the surface with lint free paper moistened with alcohol until the paper shows no additional residue being removed from the surface. Repeat for the other side. Allow the surfaces to dry before analyzing.

Small Spot Reference (Standard) Sample Care



Figure 6. The Small Spot QC Reference Sample

Small Spot QC Calibration Sample

One or more Small Spot standard(s) are supplied with your instrument if there is a Small Spot Camera activated on it. This standard should be analyzed on a daily basis and the values obtained checked against the supplied certificate of analysis. For quality assurance purposes, you may also wish to keep a running chart of the values obtained and monitor it for consistency.

If one (or more) of the elements begins to change in terms of reported concentration outside of the normal expected variability, the sample may have become contaminated. This contamination can occur for multiple reasons, for example, oils and salts may transfer from hand contact onto the surface, dust or lint from the surroundings may be deposited onto the sample, or oxidation of the surface may simply occur. If this happens, the sample will need to be cleaned to provide the XRF instrumentation with a clean surface for analysis.

17
Small Spot Reference (Standard) Sample Care

This may be achieved using clean, lint free paper, 2-propanol (isopropyl alcohol, IPA, (CH₃)₂CHOH). Do not use rubbing alcohol as this may contain oils and other contaminants. Place the sample on a clean flat surface with the analytical side facing up. Moisten the surface with the alcohol and wipe away any surface debris or contamination. Clean the surface with lint free paper moistened with alcohol until the paper shows no additional residue being removed from the surface. Allow the surface to dry before analyzing.

Thermo Scientific
Niton XL3 Analyzer User's Guide 473

- 13/13 -

3. XRF Check list

It is recommendable to record all performance data to detect some trouble sign in normal usage, at least below mentioned data list..

Handheld XRF analyser use and maintenance record

Apparatus	Thermo NITON XL3T 950 GOLDD Analyser	S/N	92641, 92727	Donated Project	JICA-2014
Project name			Use Period	from; / / 2015	to; / / 2015
User name			Place		
Date	Time records	analysed sample number	System check	Calibration	User's signature
/ /			YES NO	YES NO	
/ /			YES NO	YES NO	
/ /			YES NO	YES NO	
/ /			YES NO	YES NO	
/ /			YES NO	YES NO	
/ /			YES NO	YES NO	
/ /			YES NO	YES NO	
/ /			YES NO	YES NO	
Remarks on usage:			Company: United Spectrometer Technologies cc., Contact person: Mr. Jason Parker (Jason@ustech.co.za), Sales manager Address: Meadowbrooke Office Park, Block D, First Floor, Jacaranda ave., Olivedale 2188, South Africa Office Tel: +27(0)11 794 2105 Website: www.ustech.co.za		

Appendix 3-7

4. References

Thermo Fisher Scientific Niton Analyzers XL3 Analyzer Version 7.0.1 User's Guide-Revision C, November 2010

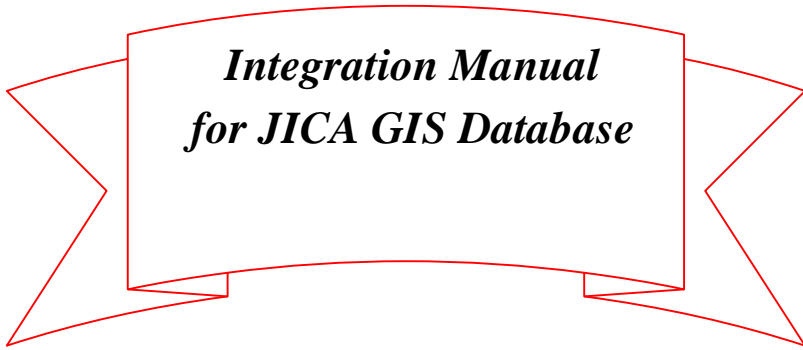

Table of Contents

1. Introduction.....	1
2. Administration of database.....	1
3. Tree structure of integrated database.....	2
4. Integrate new GIS data into database.....	5

Edition 1.0

JICA - Project on Capacity Building in Mining Sector in Malawi, 2016

Joint Venture

Sumiko Resources Exploration and Development Co., Ltd.

Mitsubishi Materials Techno Co.

1. Introduction

“Project for Establishment of Integrated Geographic Information System (GIS) Database for Mineral Resources” (hereinafter called “Previous Project”) had been carried out in the year of 2012 ~ 2013 by JICA and created GIS Database. This database was stored in two sets of Externally LAN connected type HDD (JAICA-DS) provided. However, both these two sets of HDD are in the state that they are not being usable at this stage due to their system breakage. Accordingly, JICA GIS database which was made by integrating GIS database of the previous project and the geochemical survey database created in this project is to be preserved in USB connection type portable HDD, and supplied to GSD. This manual is to stipulate the unification of new JICA GIS database and the standard for management and control of this database.

2. Administration of database

(1) Management and Control of Portable HDD

USB connection type portable HDD in which integrated JICA GIS database is preserved is to be possessed by the director of GSD, and management and control of the same are to be carried out by himself, only the administrator of PC approved by the director of GSD can access to the said HDD. The administrator is to borrow the said HDD upon obtaining the permission from the director of GSD, and the renewal work as well as the preparation of backup data is to be carried out by using the desktop PC provided at the previous project.

(2) Management and Control of User's Name and Log-in Passwords Desktop PC for Working

The administrator is carrying out the work upon logging-in the new user's name and passwords determined into the desktop PC. The user's name and the login password are to be managed and controlled by the director of GSD and the administrator.

In addition, the administrator shall not carry out the work by using the user's name and the login pass word which is normally used by staff(s) of GSD.

(3) Backup of GSD-database

Backup directory is to be prepared in the working desktop PC, and the renewed GIS-database is to be kept and stored in the said backup directory.

(4) Utilization of Data by GSD Staffs

Staff(s) who obtained the permission from the director of GSD can utilize the copy of this database in other PC.

3. Tree structure of integrated database

The tree structure of directory which is integrated into “JICA_GIS_database” in this project is as shown in the following. The directory “JICA_GIS_database” is composed of four (4) sub-directories, i.e. “GIS_Data”, “Geologic_Maps100K”, “Satellite_data” and “Geochemical_survey_data”.

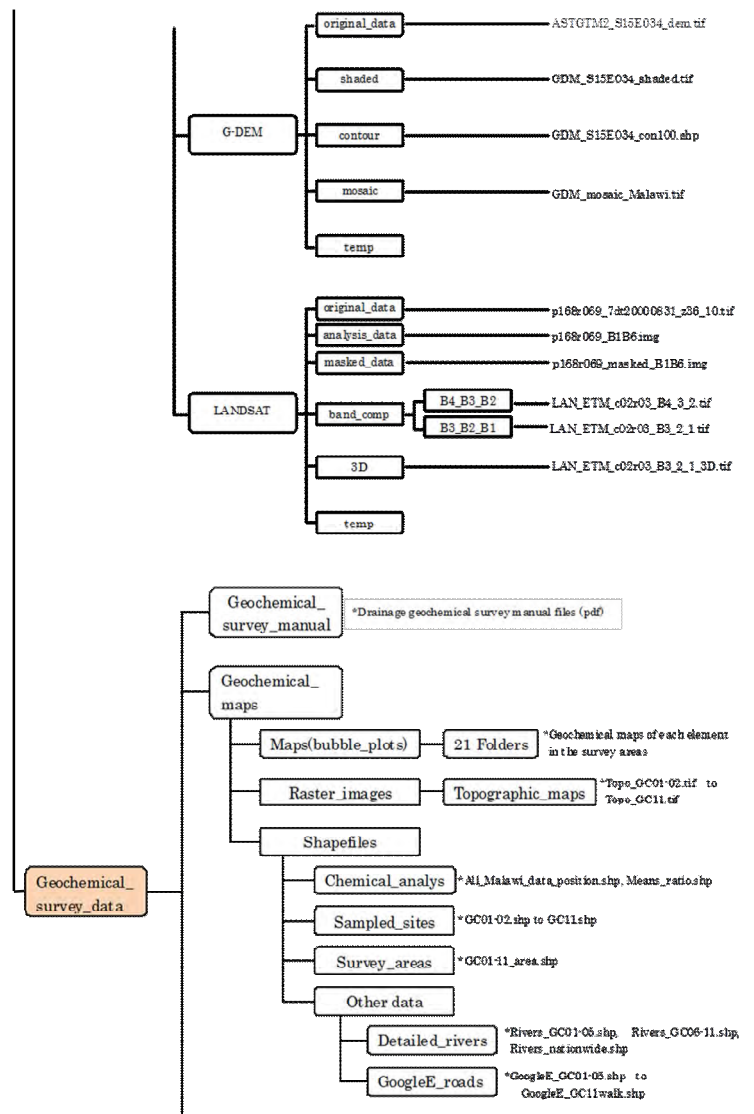
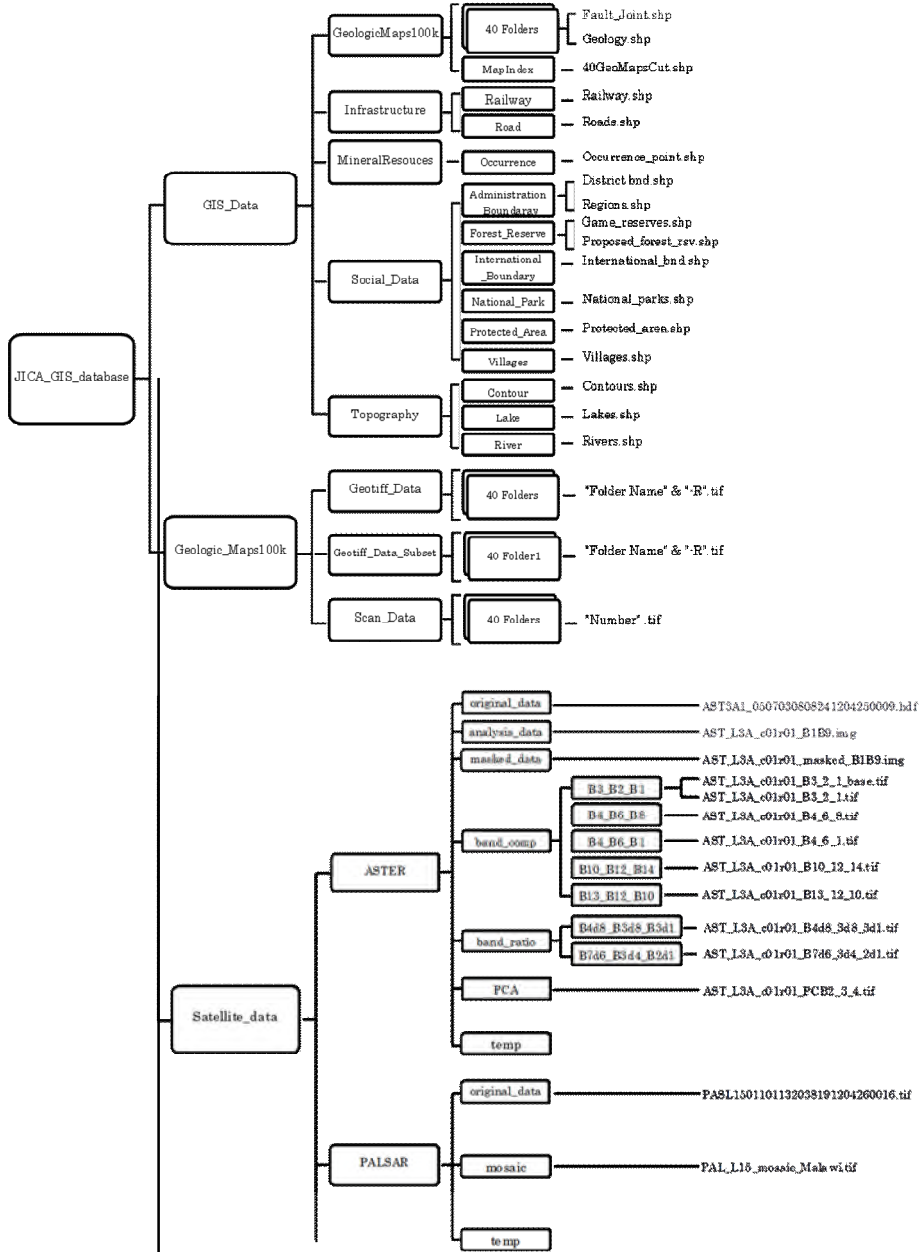

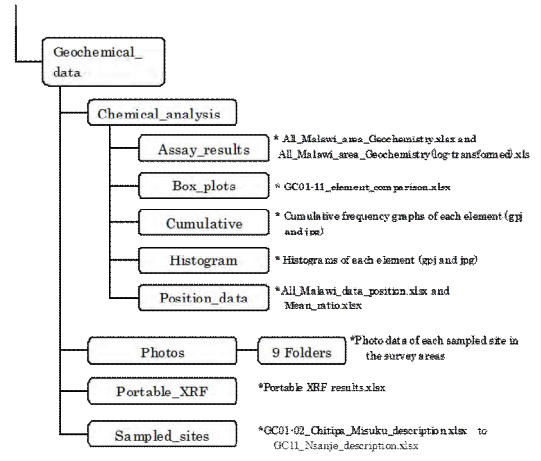

After starting up of ArcMap, name of non-displayed data in the left side column is to be selected and double clicked.

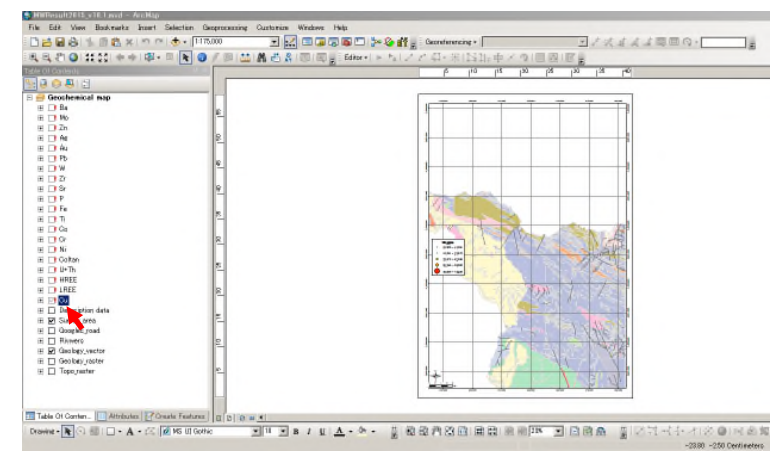

- 4/5 -

4. Integrate new GIS data into database

The administrator borrows a portable HDD upon obtaining a permission from the director of GSD, and connects HDD to the desktop PC as a sort of provided equipment. Name of user and log-in password is to be logged in upon setting up of PC, and "JICA_GIS_database" in HDD is to be stored in any of directories in the desktop PC, and the work is to be carried out in this directory. "JICA_GIS_database" is to be copied and stored in the backup directory as soon as possible upon the renewal of data.

In case that this database is to be renewed due to the preparation of new GIS data, the new GIS data which are corresponding to the subdirectory of "Geochemical_survey_data" are to be stored respectively and this database is to be renewed. This database is to be managed and controlled in ArcMap as the software provided, and the new GIS data is to be additionally stored and displayed.

In addition, in case that the administrator and/or staff(s) of GSD are to make copy of this database to other PC, the copy made from "JICA_GIS_database" as the root directory of this database is to be utilized. Also, components of the directory should not be changed. If only the required holder(s) is to be utilized by copying to other PC, the pass of respective GIS data files registered in the ArcMap file (.mxd) is to be cut off and data will not be displayed even though ArcMap is opened. In case that non-displayed data are in existence, its rectification is to be carried out in manners and procedures as follows.

From the screen of "Layer Properties" menu, "Source" is to be selected and the name of original data file is to be confirmed. After confirmation, "Cancel" is to be clicked.

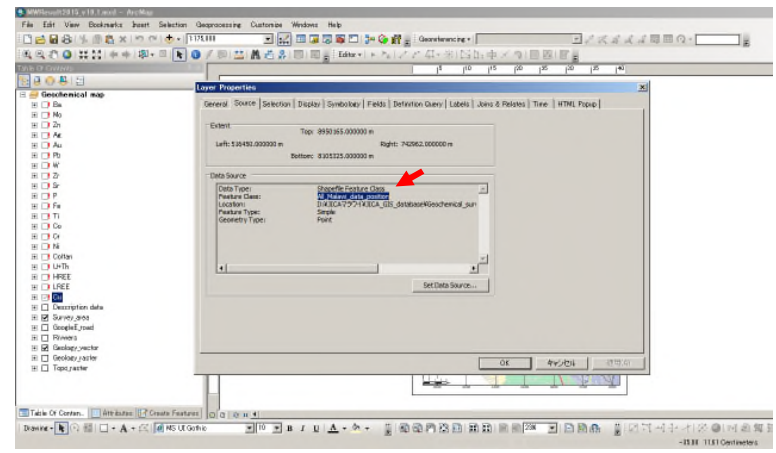

Next, red colored “exclamation mark” at the left side in non displayed data of “Table of Content” is to be clicked.

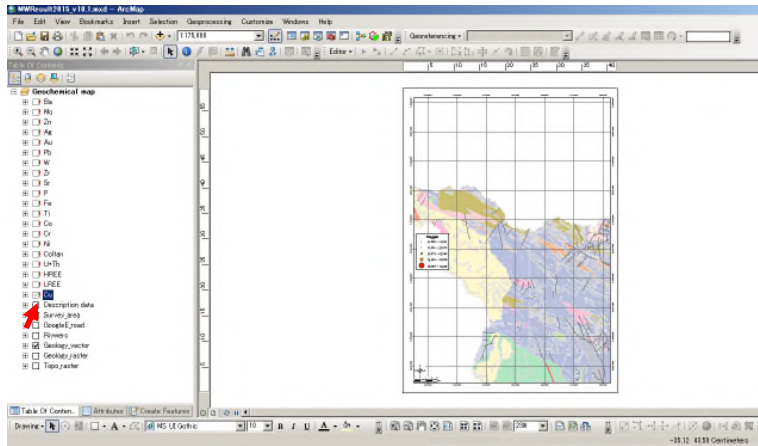

- 5/5 -

As “Set Data Source” menu is displayed, appropriate data file is to be selected and push “Add” button. And confirm whether non-displayed data are appropriately displayed.

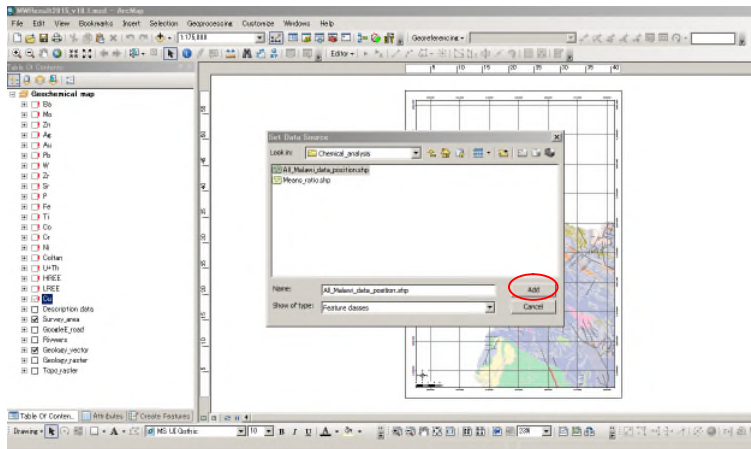

end of document



Karen Hayes, Director Mines to Markets, Pact

Artisanal and Small-scale Mining Consultative Symposium
Lilongwe, Malawi, 11-12 November 2014

Overview of Artisanal and Small-scale Mining: the Global Context and Pact's Work



Overview

- Introduction to Pact
- Basic definitions and examples of ASM/SSM
- Minerals, countries, scale
- ASM economics
- Social and environmental issues in ASM
- Examples of Pact's work
- Some thoughts for the Symposium

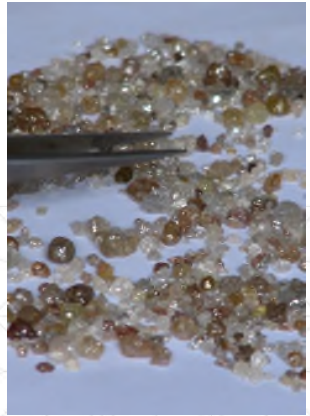

Pact's Core Values

- International development NGO based in Washington DC
- 43 years old, working in 27 countries, in Malawi since 2007
- **Local Solutions** – our success comes from solutions created with the people we serve.
- **Partnerships** – partnerships deepen our impact and promote empowerment.
- **Results** – our work must transform lives and make them measurably better. How that change occurs is as important as the change itself.



Why does Pact work in the mining sector?

1. **Mining is the unsustainable extraction of non-renewable resources.** The transformation of mineral wealth into social value is of critical importance and **we only get one chance**
2. **30m men, women and children depend on artisanal mining globally.** They often work in remote areas, with poor standards, with little access to social services. They are largely neglected by NGOs and donors despite being the primary economic force in many rural areas.





ASM: definitions, characteristics, scale, scope and issues

Characteristics of Artisanal Mining

- Manual extraction of minerals using rudimentary tools
- Little formal prospection or mine planning
- Processing at a basic level
- Inefficient techniques and poor recovery rates
- Often illegal or informal, weak resource rights





Characteristics of Small-scale Mining

- Often governed by different regulations than artisanal mining
- Includes a certain level of mechanization but maintains high level of employment
- Typically will have an investor with some level of resource rights and responsibilities
- Often better efficiency than artisanal mining





Scale of ASM worldwide

- Industrial mining: 90% of world output, but just 10% of mining workforce.
- Artisanal & small-scale mining: 10% of world output, 90% of mining workforce
- 30-50 million miners in 70 countries
- 50% of ASMs are women
- ASM works in virtually all industrial, quarry, precious and semi-precious minerals – both metals and stones – as well as coal, salt, sand, and other materials
- ASM produces: 15-20% of all gold, 15% of all diamonds, 60% of all tin, 80% of all colored gemstones
- They are the world's "hidden suppliers"



Economic importance of ASM

- Critically important non-agricultural rural livelihood
- Provides a daily income independent of crop success
- Can be full time, seasonal or supplementary
- Can be a coping mechanism in times of crisis
- BUT.....



Social and environmental issues

- May involve Worst Forms of Child Labor
- Gender inequity
- Linked to conflict and insecurity
- Linked to fraud, corruption and illegal trade
- Disruption of traditional communities and rights
- Migratory workforce and spread of infectious disease
- Poor health and safety standards
- Use of hazardous materials
- Environmental damage and impact on water supplies



building
local
promise.



Pact's work in ASM worldwide





pact building local promise.

Some key thoughts as we move into the Symposium

Some thoughts for the Symposium

- Beware of formalizing mining without formalizing trading
- There are many social and development issues to consider but, at its core...
- **Mining is business.** Solutions have to be viable, profitable and have to incentivize participation
- **CONGRATULATIONS!**
- The prioritization process is important – let's get the groundwork right

pact

