

Appendix2.1-14 Result for Diffusion Simulation in Every Year

1 Simulation Result

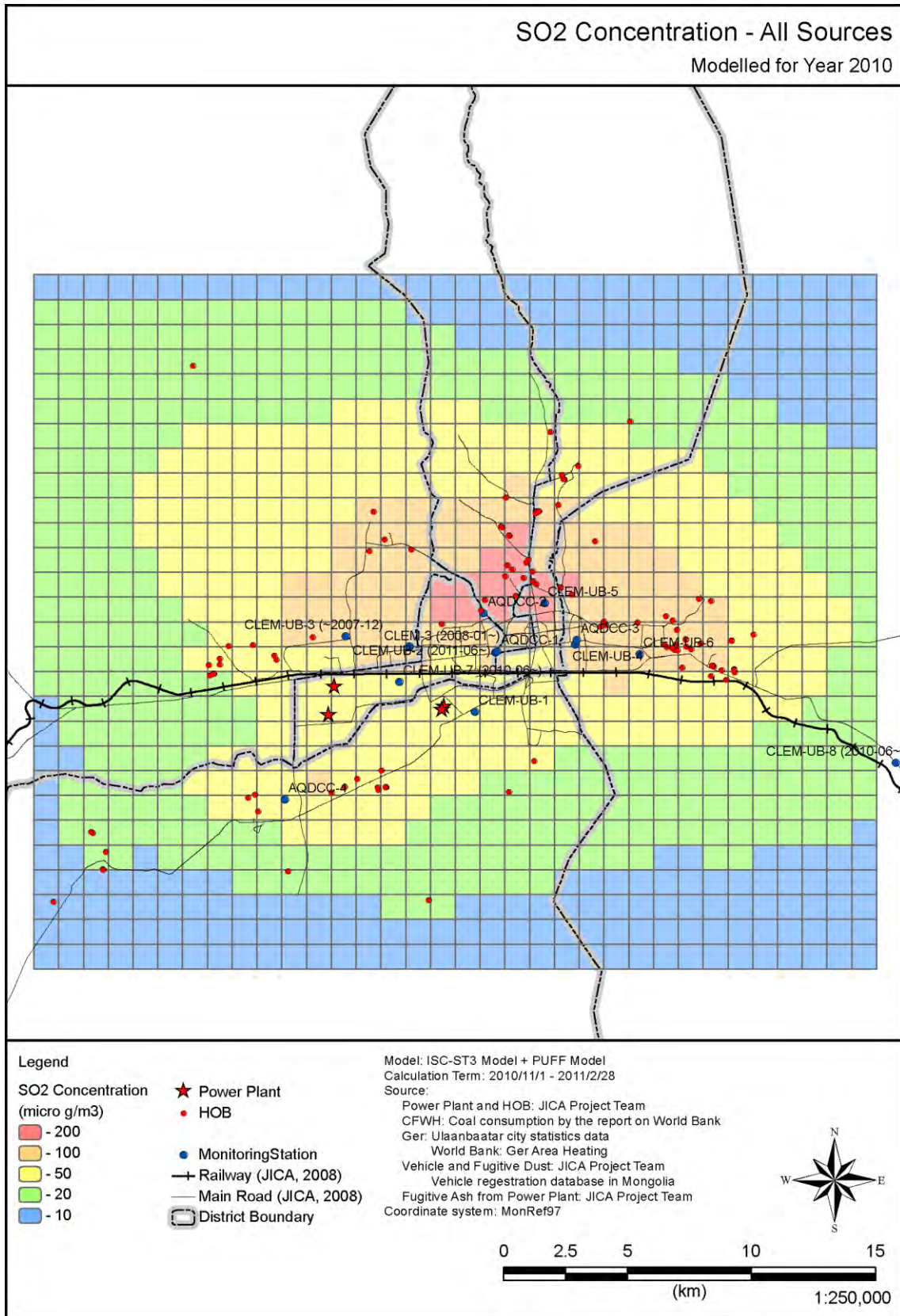

Figure 1-1 SO₂ Simulation Result (2010, Expert Judgement Case)

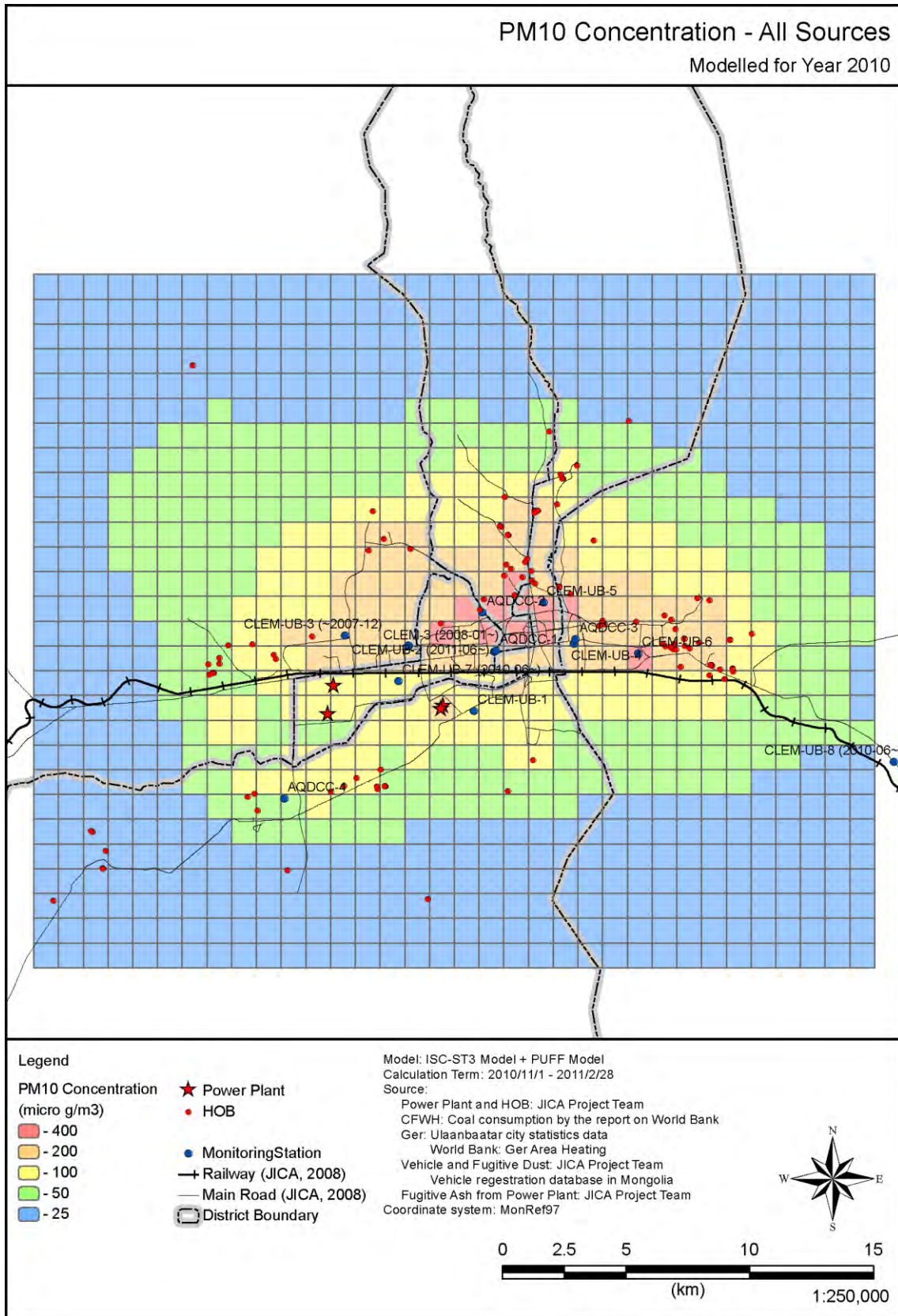

Figure 1-2 PM₁₀ Simulation Result (2010, Expert Judgement Case)

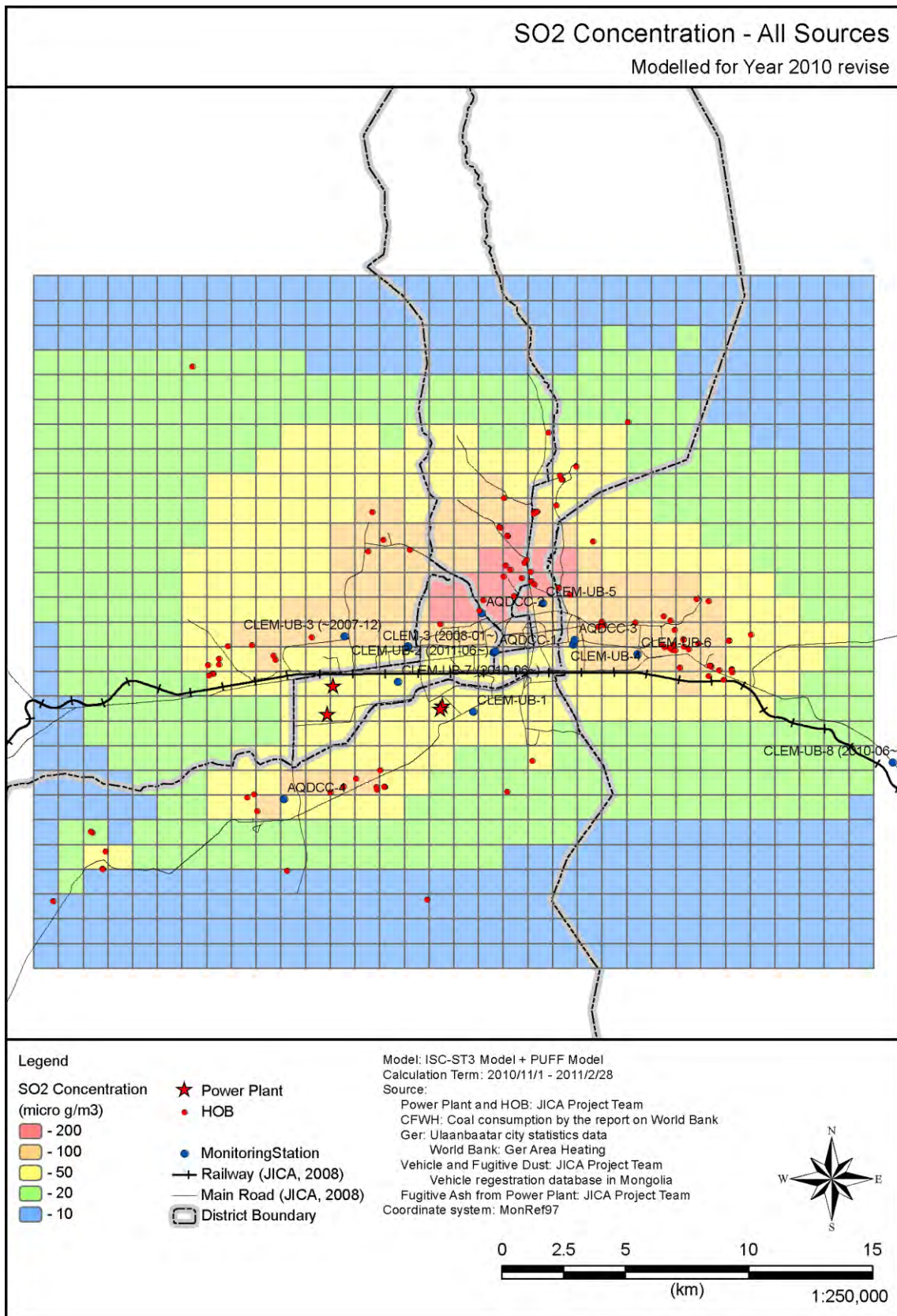

Figure 1-3 SO₂ Simulation Result (2010 revise)

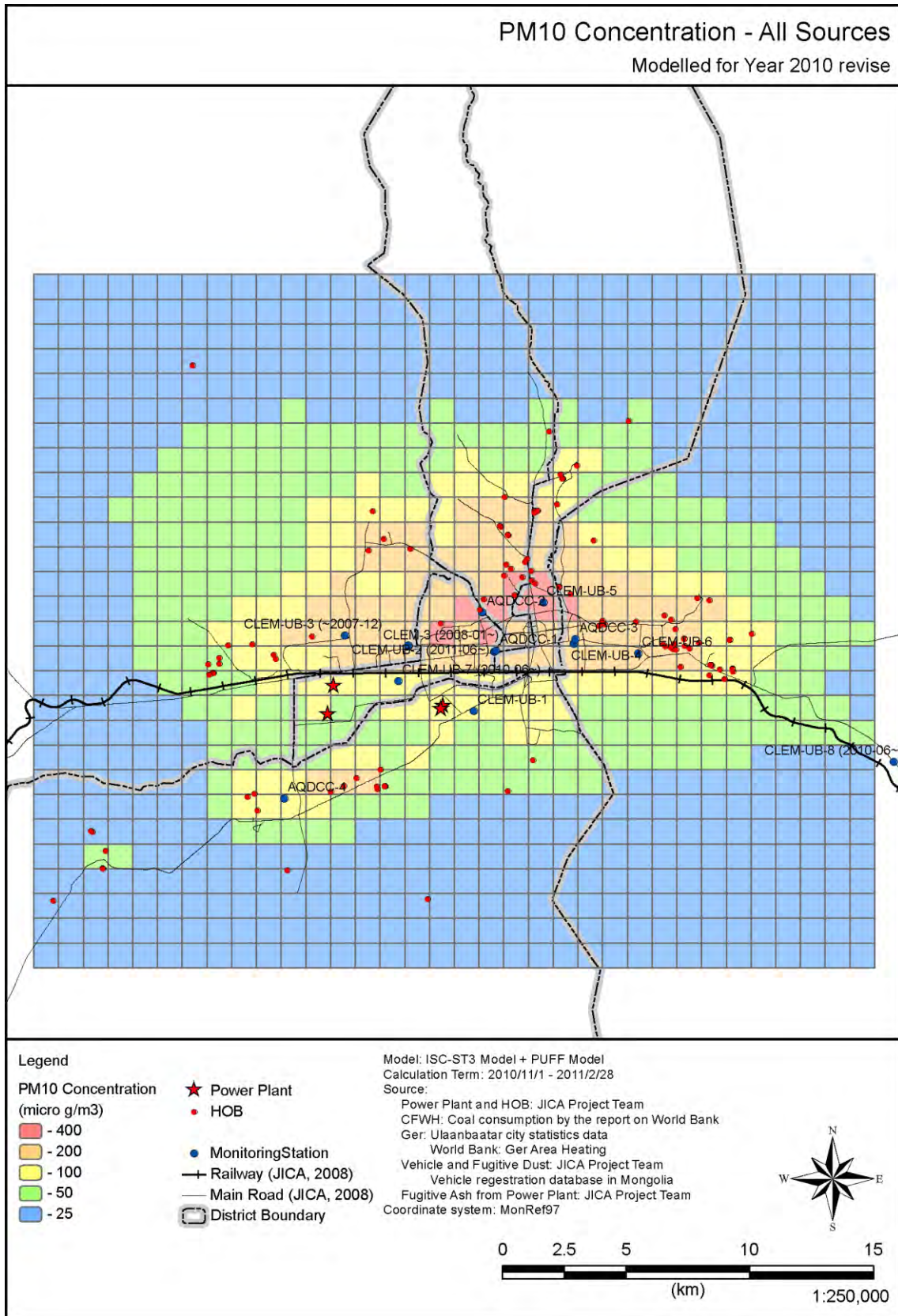

Figure 1-4 PM₁₀ Simulation Result (2010 revise)

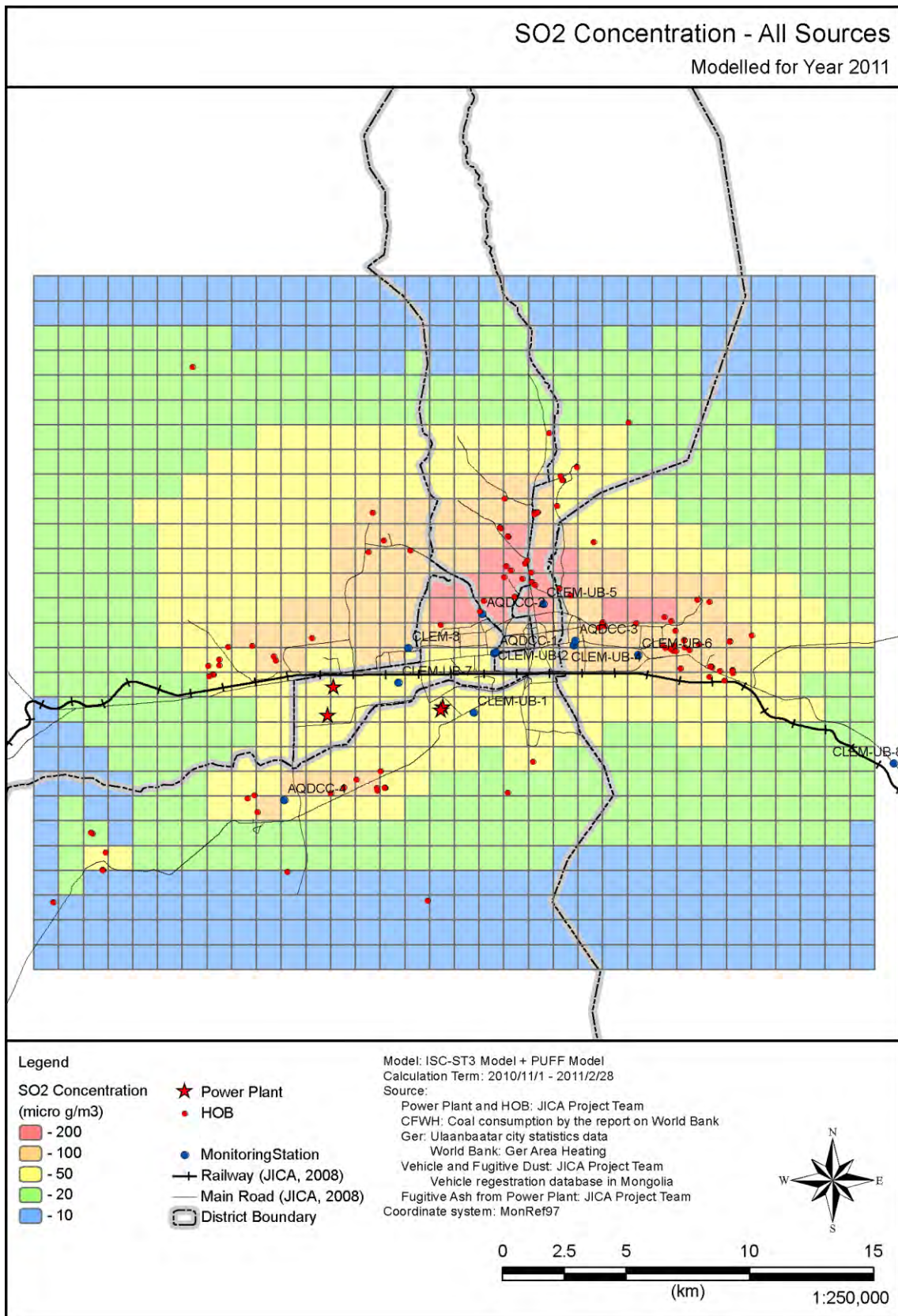

Figure 1-5 SO₂ Simulation Result (2011)

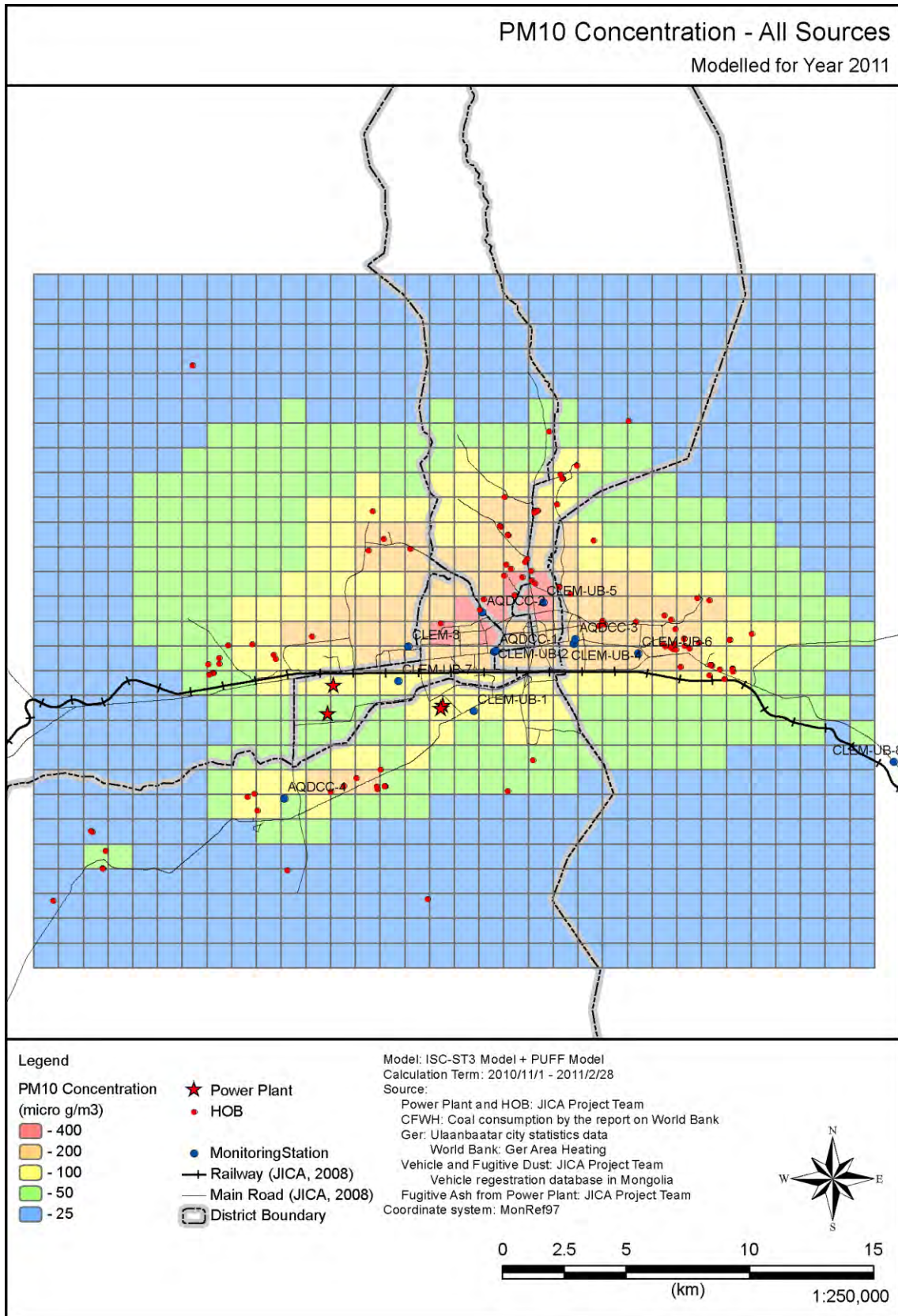

Figure 1-6 PM₁₀ Simulation Result (2011)

2 Evaluation of Simulation Result

Table 2-1 Comparison between Ambient Standard and Simulation Results

Target Pollutants	Target year	Number of Annual Ambient Standard Excess Meshes / Number of all Calculation Meshes (Excess Percentage)	Number of Daily Ambient Standard Excess Meshes / Number of all Calculation Meshes (Excess Percentage)
SO ₂	2010	724/952 (76.05%)	359/952 (37.71%)
	2010 revise	624/952 (65.55%)	290/952 (30.46%)
	2011	670/952 (70.38%)	322/952 (33.82%)
NO ₂	2010	164/952 (17.23%)	105/952 (11.03%)
	2010 revise	72/952 (7.56%)	34/952 (3.57%)
	2011	57/952 (5.99%)	26/952 (2.73%)

Appendix2.1-15 Result for Diffusion Simulation for HOB

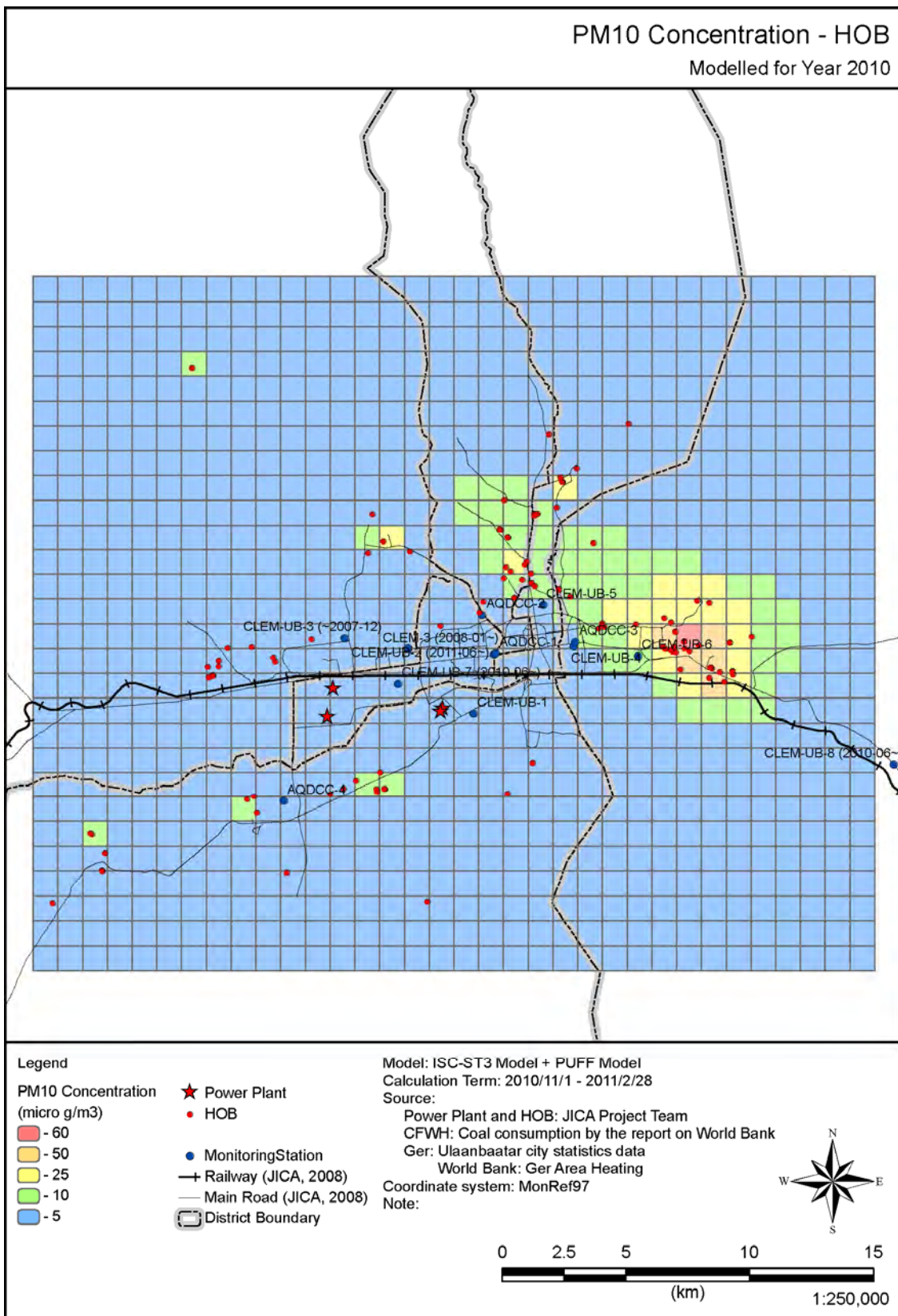

Figure 1 HOB Simulation Result (PM₁₀, Expert Judgment Case)

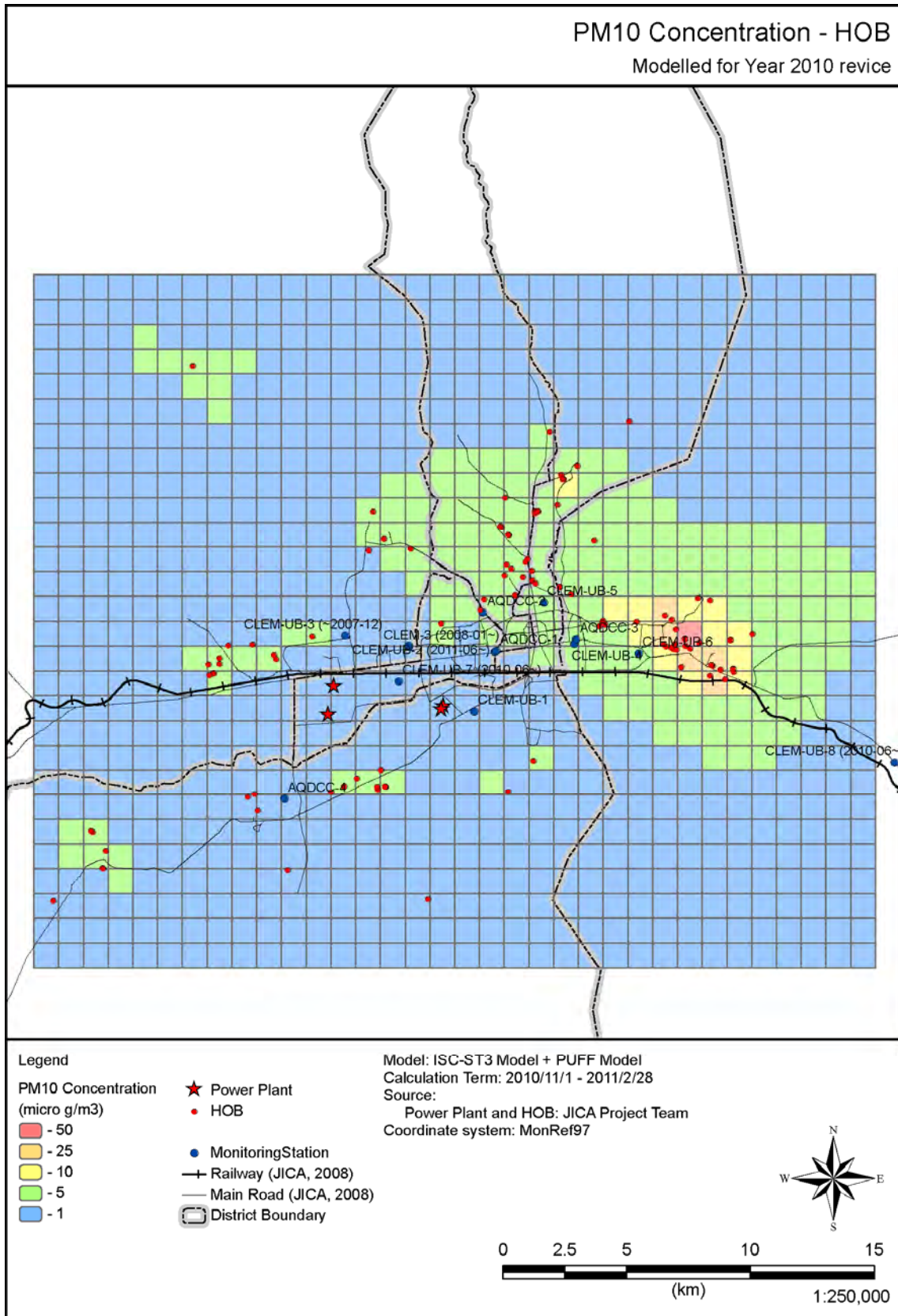

Figure 2 HOB Simulation Result (PM₁₀, 2010 revise)

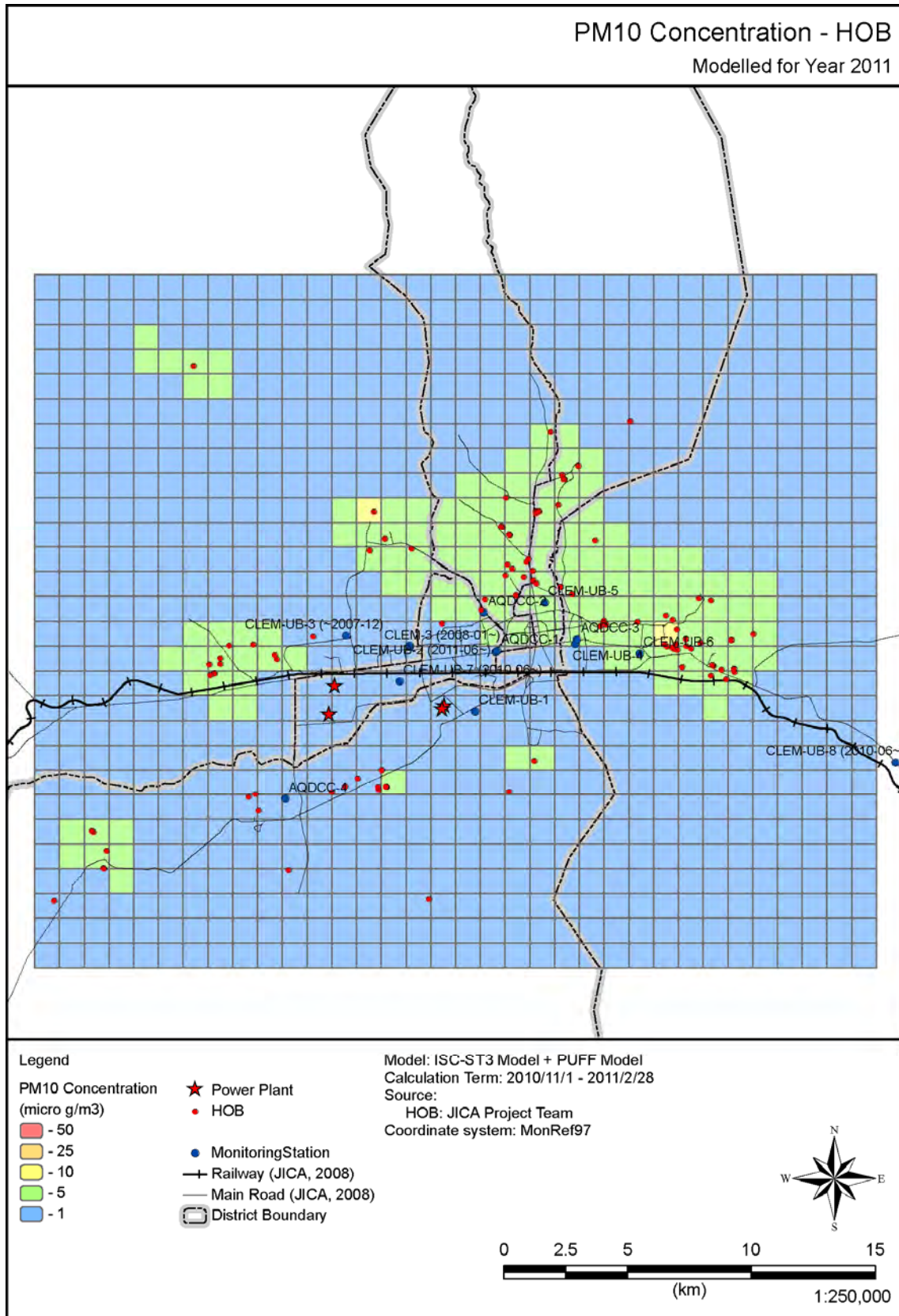
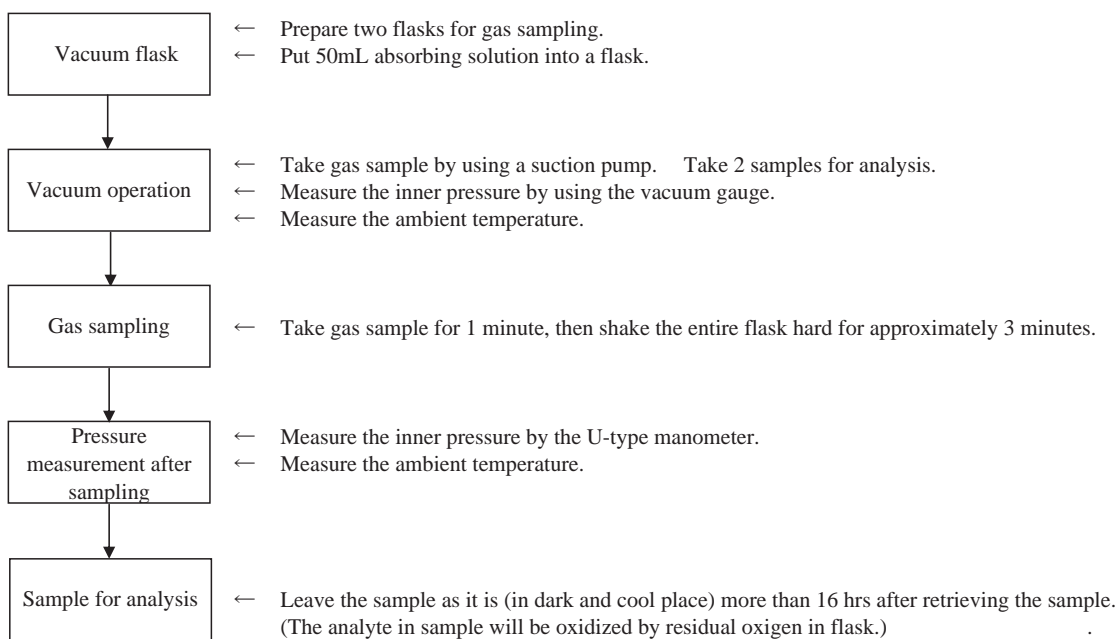

Figure 3 HOB Simulation Result (PM₁₀, 2011)

Appendix2.2-1 Training Handout on Stack Gas Measurement

Measurement method of nitrogen oxides in flue gas (JIS K 0104)

Naphtylethylenediamine Absorptiometry (NEDA method)



Measurement method of sulfur oxides in flue gas (JIS K 0103)

Precipitation titration method (Arsenazo III method)

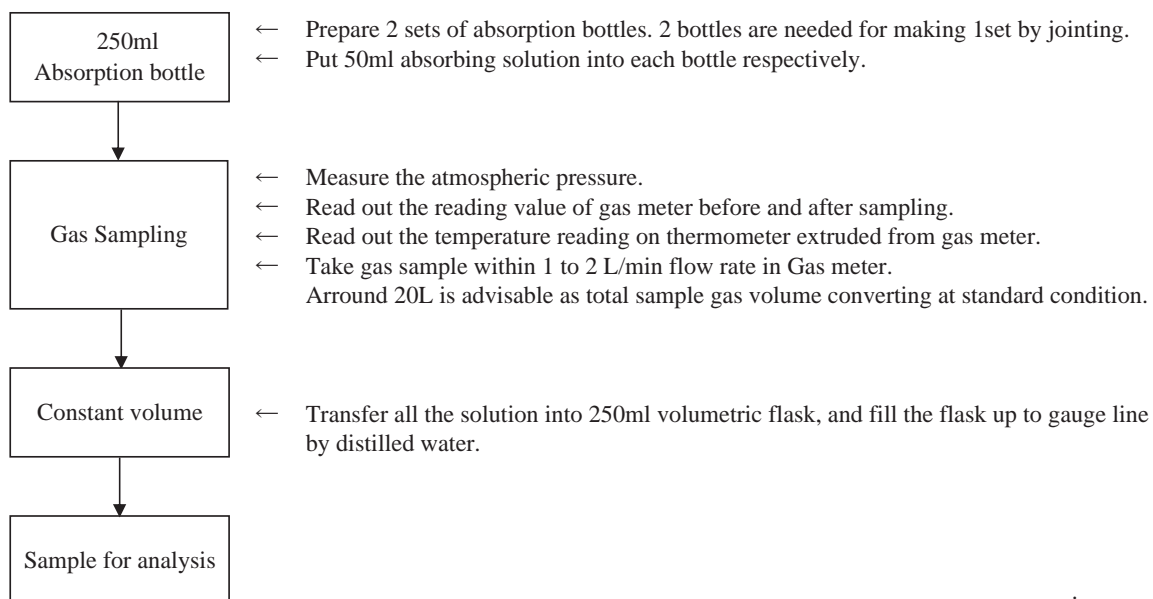

Quoted from Method for measuring dust concentration in Flue gas (JIS Z 8808)

Measurement of moisture content (moisture absorption tube method)

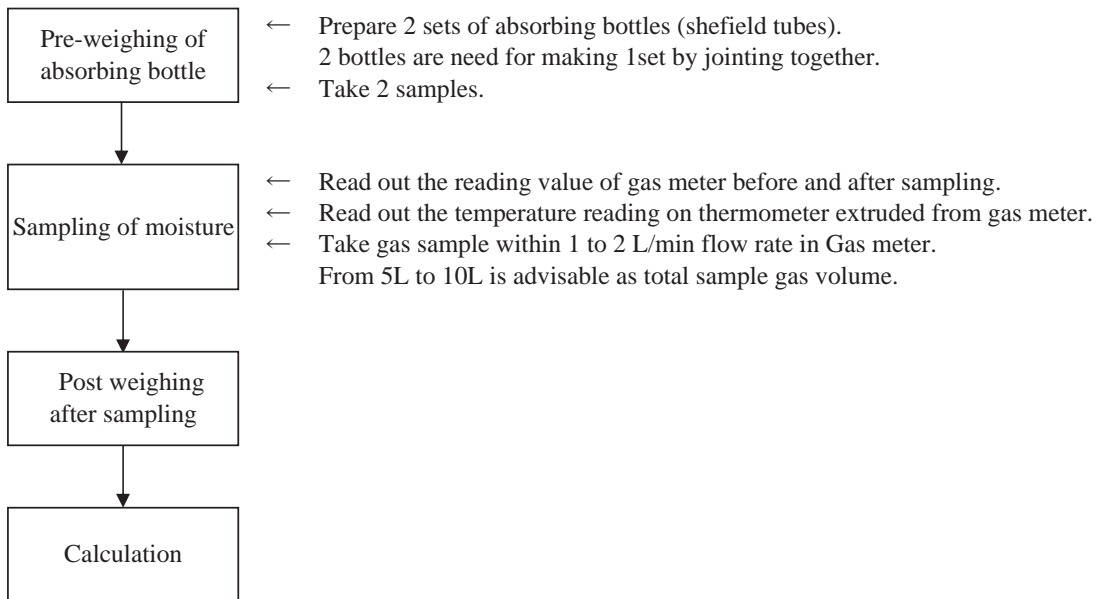

Formula

$$X_w = \frac{\frac{22.4}{18} m_a}{V_m \times \frac{273}{273 + \theta_m} \times \frac{P_a + P_m - P_v}{101.3} + \frac{22.4}{18} m_a} \times 100$$

Where;

V_m : volume of gas sucked (L)

θ_m : temperature of suction gas in gas meter ($^{\circ}\text{C}$)

m_a : mass of moisture absorbed (g)

P_a : atmospheric pressure (kPa)

P_m : gauge pressure of gas in the gas meter (kPa)

P_v : saturated water vapor pressure at θ_m (kPa)

Quoted from Method for measuring dust concentration in Flue gas (JIS Z 8808)

Measurement of gas composition of flue gas (Orsat analysis method)

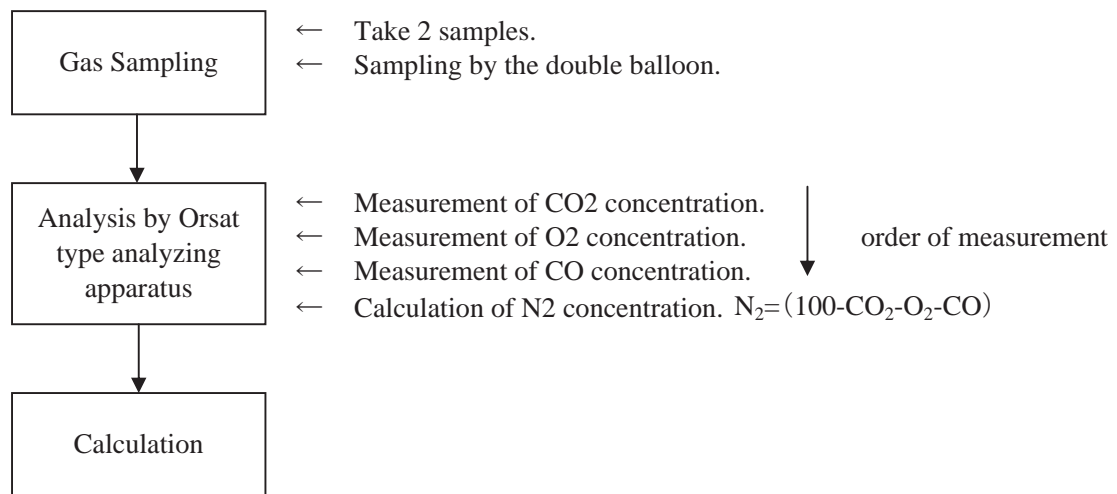

Formula

$$\rho_0 = \frac{1}{22.4 \times 100} \left[\{44 \times \text{CO}_2 + 32 \times \text{O}_2 + 28(\text{CO} + \text{N}_2)\} \left(1 - \frac{\chi_w}{100}\right) + 18 \times \chi_w \right]$$

$$\rho = \rho_0 \times \frac{273}{273 + \theta_s} \times \frac{P_a + P_s}{101.3}$$

Where;

CO₂: volume percentage of carbon dioxide contained in dry flue gas (%)

O₂: volume percentage of oxygen contained in dry flue gas (%)

CO: volume percentage of carbon monoxide contained in dry flue gas (%)

N₂: volume percentage of nitrogen contained in dry flue gas (%)

p: density of flue gas in duct (kg/Nm³)

p₀: density of wet flue gas converted in standard condition (kg/m³)

θ_s: temperature of flue gas (°C)

X_w: volume percentage of of water vapor in flue gas (%)

P_s: static pressure of flue gas (kPa)

P_a: atmospheric pressure (kPa)

Quoted from Method for measuring dust concentration in Flue gas (JIS Z 8808)

Measurement of static pressure of flue gas

Measurement of
static pressure

← Measured by U-shape manometer.

Formula

• Static pressure (Pa) = $P_s(\text{mmH}_2\text{O}) \times 9.81 / 1000$

• Static pressure (Pa) = $P_s(\text{mmHg}) / 760 \times 101.3$

Quoted from Method for measuring dust concentration in Flue gas (JIS Z 8808)

Measurement of temperature of flue gas

Measurement of
temperature

← Measured by the portable digital thermometer.

Location of measuring hole and measuring point

(1) Determination of measuring position

The measuring position shall be located at a place where the flue gas is under a relatively uniform flow and the measurement is performed safely and easily, avoiding the place where a duct bends or its sectional shape is sharply changed.

The selection of a duct chosen as the measuring position shall be equally divided into a suitable number of areas according to its shape and size, and the measuring point shall be allotted in each area.

Measurement points for Circular cross section

Applicable diameter of duct $2R$ (m)	Number of divisions by radius	Number of measuring points	Distance from center of duct to the measurement point (m)				
			r_1	r_2	r_3	r_4	r_5
$2R \leq 1$	1	4	$0.707R$	—	—	—	—
$1 < 2R \leq 2$	2	8	$0.500R$	$0.866R$	—	—	—
$2 < 2R \leq 4$	3	12	$0.408R$	$0.707R$	$0.913R$	—	—
$4 < 2R \leq 4.5$	4	16	$0.354R$	$0.612R$	$0.791R$	$0.935R$	—
$4.5 < 2R$	5	20	$0.316R$	$0.548R$	$0.707R$	$0.837R$	$0.949R$

Measurement points for Rectangular and Square cross section

Sectional area of applicable duct A (m^2)	Length of a divided side L (m)
$A \leq 1$	$L \leq 0.5$
$1 < A \leq 4$	$L \leq 0.667$
$4 < A \leq 20$	$L \leq 1$

Measurement points for circular cross section (in case of 12 measurement points)

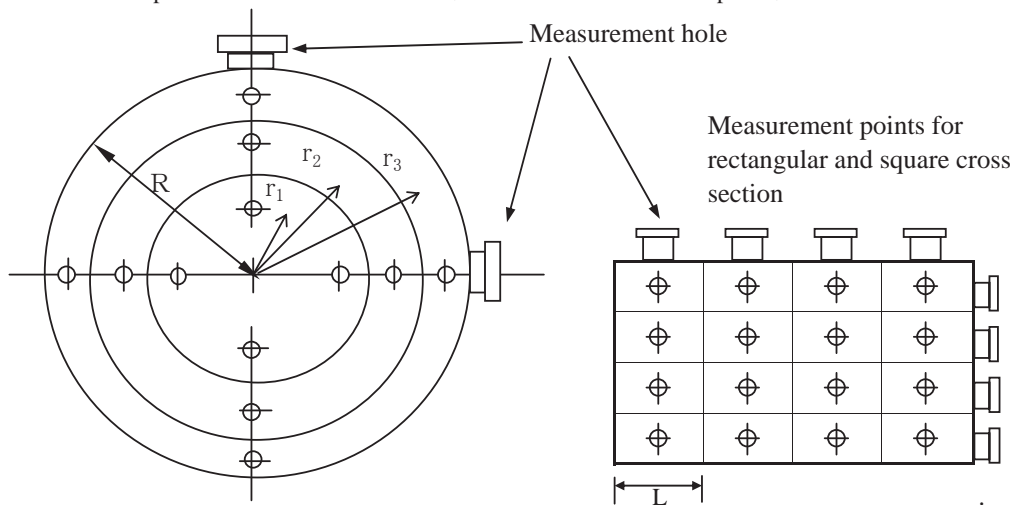

Quoted from Method for measuring dust concentration in Flue gas (JIS Z 8808)

Isokinetic sampling (method with common type sample collection device)

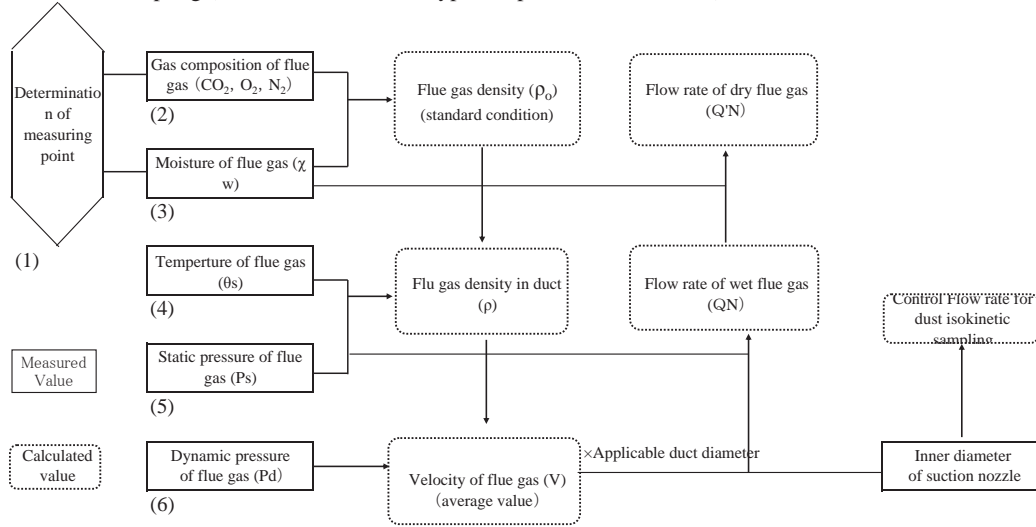

$$\chi_w = \frac{\frac{22.4}{18} m_a}{V_m \times \frac{273}{273 + \theta_m} \times \frac{P_a + P_m - P_v}{101.3} + \frac{22.4}{18} m_a} \times 100$$

where;

V_m: Suction volume (L)

P_a: Atmospheric pressure (kPa)

θ_m: Gas temperature at the meter (°C)

P_m: Gas pressure at the meter (kPa)

m_a: Mass of moisture (g)

P_v: Saturated vapor pressure at θ_m (kPa)

$$\rho_0 = \frac{1}{22.4 \times 100} \left[\{44 \times \text{CO}_2 + 32 \times \text{O}_2 + 28(\text{CO} + \text{N}_2)\} \left(1 - \frac{\chi_w}{100}\right) + 18 \times \chi_w \right]$$

Where;

ρ: Exhasust gas density (within the duct) (kg/Nm³)

ρ₀: Exhasust gas density (standard condition) (kg/m³)

P_s: Static pressure of flue gas (kPa)

P_d: Dynamic pressure of flue gas (Pa)

C: Coefficient of pitot tube

$$\rho = \rho_0 \times \frac{273}{273 + \theta_s} \times \frac{P_a + P_s}{101.3}$$

$$v = c \sqrt{\frac{2P_d}{\rho}}$$

$$Q_N = A \times v \times \frac{273}{273 + \theta_s} \times \frac{P_a + P_s}{101.3} \times 60 \times 60$$

Q_N: Flow rate of wet flue gas (Nm³/h)

Q'_N: Flow rate of dry flue gas (Nm³/h)

$$Q'_N = Q_N \left(1 - \frac{\chi_w}{100}\right)$$

V: Velocity of flue gas (m/s)

d: Inner diameter of selected suction nozzle (mm)

X_w: Moisture in flue gas (%)

A: Applicable duct diameter (m²)

θ_s: Flue gas temperature (°C)

Q_m: Control Flow rate for dust isokinetic sampling (L/min)

$$q_m = \frac{\pi}{4} d^2 \left(1 - \frac{\chi_w}{100}\right) \frac{273 + \theta_m}{273 + \theta_s} \times \frac{P_a + P_s}{P_a + P_m - P_v} \times v \times 60 \times 10^3$$

Method for measuring dust concentration in Flue gas (JIS Z 8808)

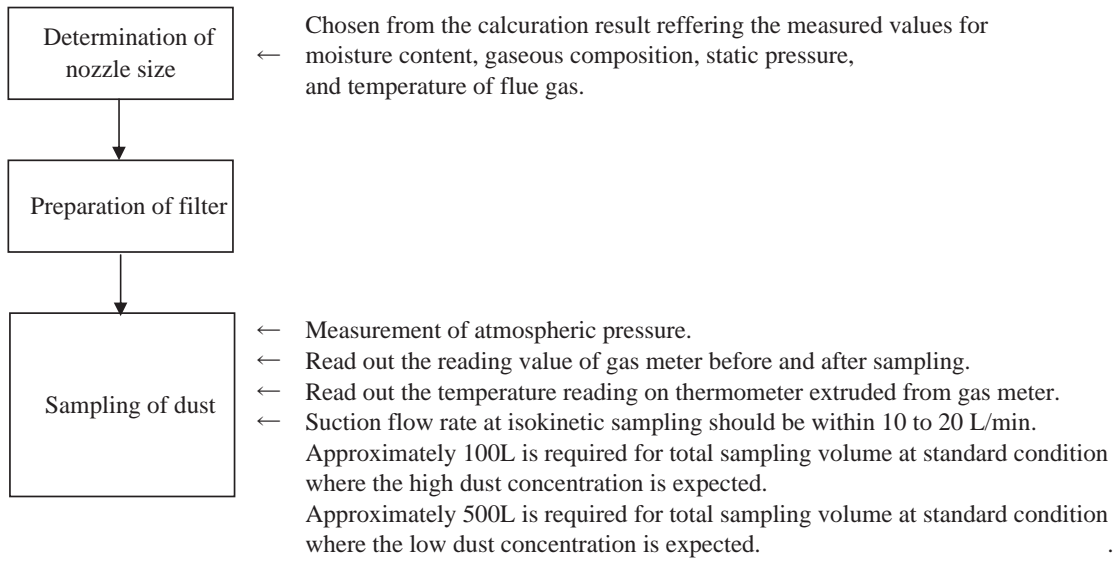

Analytical principle for determination of nitrogen oxides in flue gas (JIS K 0104)

Naphthylethylenediamine Absorptiometry (NEDA method)

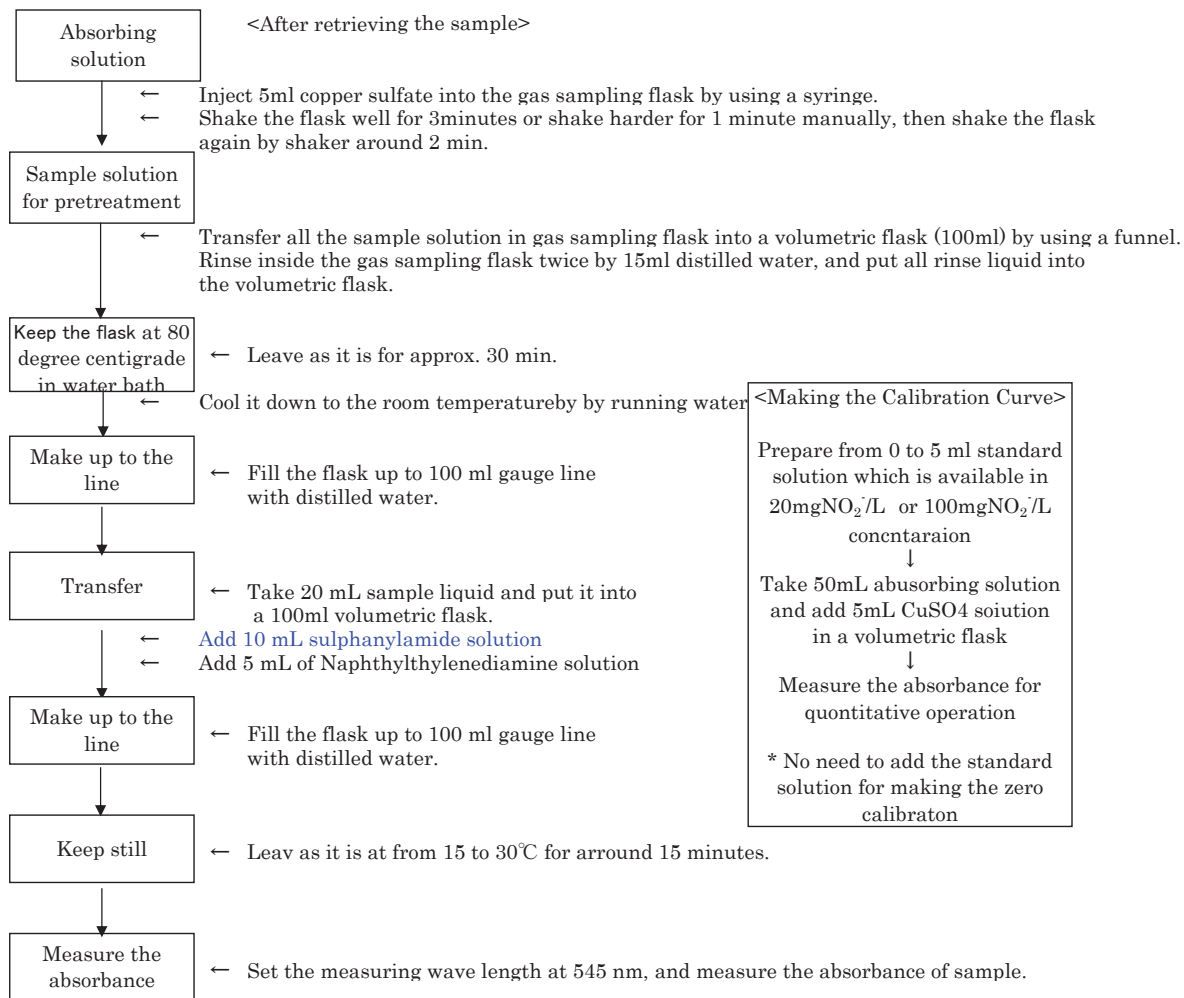

<Making the Calibration Curve>

Prepare from 0 to 5 ml standard solution which is available in 20mgNO₂/L or 100mgNO₂/L concentration

↓

Take 50mL absorbing solution and add 5mL CuSO₄ solution in a volumetric flask

↓

Measure the absorbance for quantitative operation

* No need to add the standard solution for making the zero calibrator

* The blank value must be subtracted from the sample value in the quantitative operation.

Analytical principle of sulfur oxides in flue gas (JIS K 0103)

Precipitation titration method (Arsenazo III method)

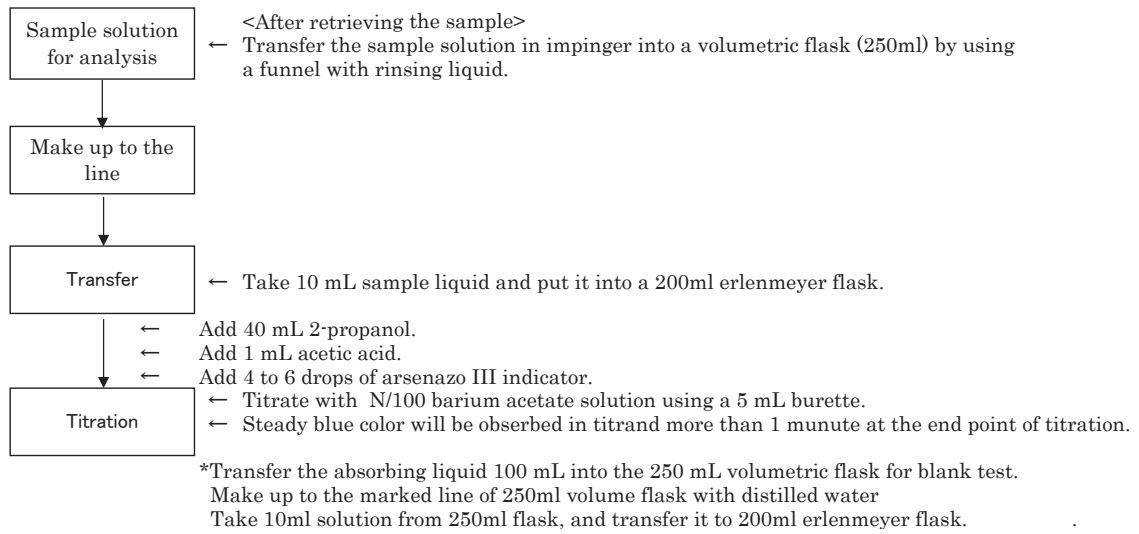

Method for measuring dust concentration in flue gas (JIS Z 8808)

Weighing of cylindrical filters

<Pre-weighing>

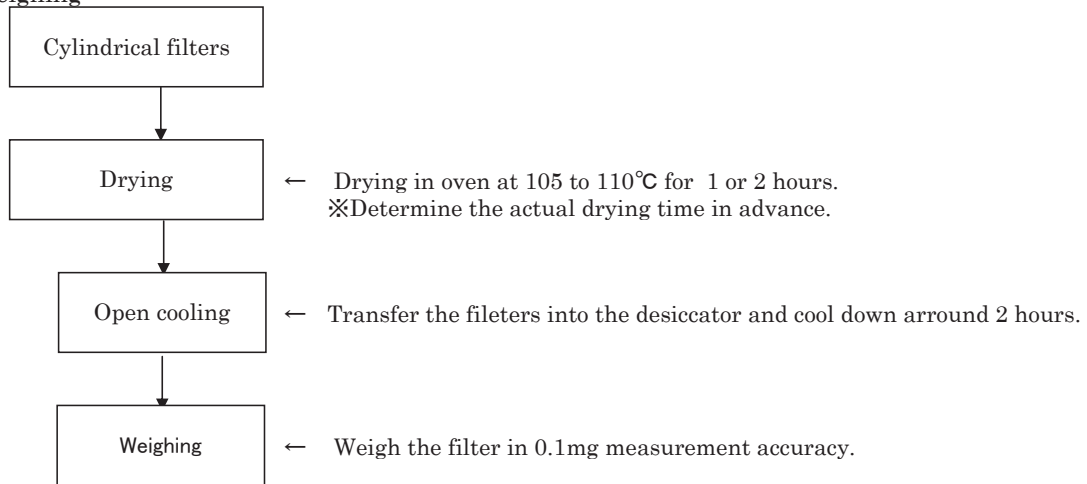

<Post weighing after>

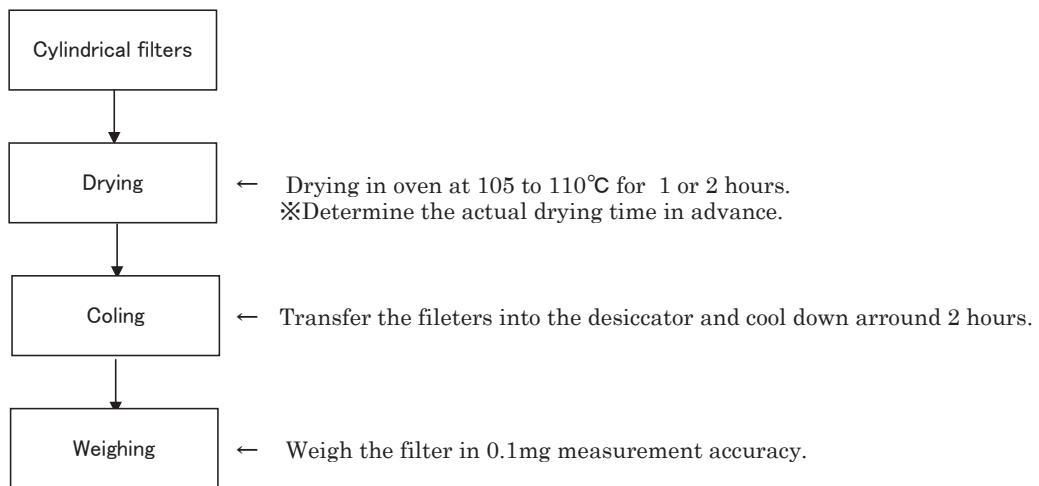

* Leave the values of weighing results on record sheet for pre-weighing, post weighing and their difference value.

SO_x Analysis for Stack Monitoring

Measurement method: Precipitation Titrimetry (Arsenazo III)

1. Outline of H₂S gas Analysis for Stack Monitoring

1.1 Gas Sampling

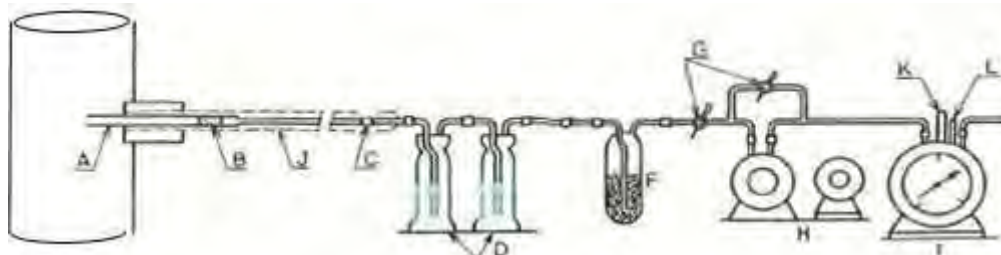

1.2 Analysis method

Precipitation Titrimetry (Arsenazo III)



2. Preparation

2.1 Absorbing Solution

Reagent

1. H₂O₂ (Hydrogen Peroxide) 30% 30ml

2. Deionized water 270ml

Put respectively 50 ml **Absorbing solution** into 250 ml impingers. Prepare 2 bottles.

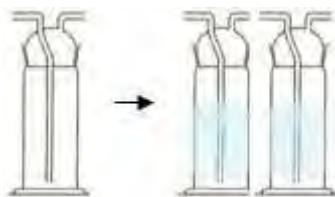

3. Gas Sample Collection at Site (Stack)

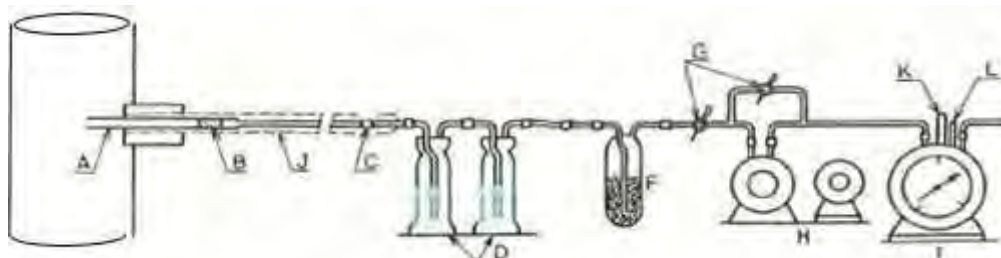

Leak check test must be done before starting of gas sampling

Gas Sampling Flow rate: **around 1 l/min**

Total sampling gas volume: **around 20 liters**

SO_x Analysis for Stack Monitoring

Measurement method: Precipitation Titrimetry (Arsenazo III)

4. Analysis by Titrimetry

4.1 Preparation

Reagent

1. Deionized water
2. H₂SO₄ 0.05 mol/L (Sulfuric acid) 500ml bottle
3. Arsenazo III
4. Ba(OCOCH₃)₂ (Barium acetate) 500g bottle
5. Pb(OCOCH₃)₂ · 3H₂O (Lead acetate trihydrate) 500g bottle
6. CH₃COOH (Acetic acid) 500ml bottle
7. 2-propanol 500ml bottle
8. C₂H₅OH (Ethanol 95) 500ml bottle
- Стандартчилал тогтоох уусмал-----
9. Bromophenol blue
10. NaCO₃ (Sodium carbonate / anhydrous)

4.1.1 Preparation of 2 mmol/L H₂SO₄



+ Deionized water

25 дахин
шингэрүүлэх

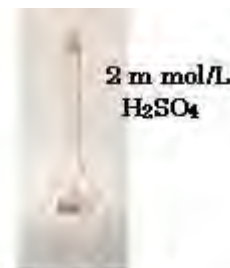

Fill the flask up to
500 ml gauge line

Хэрэглэх уусмалын тухайд 「H₂SO₄ 0.05 mol/L」 урьдчилан Factor-г нь тодорхой болгохгүй бол болохгүй. Энэ удаад худалдаалагдаж буй зүйл болохоор ямар Factor-той болох нь тодорхой зүйлийг хэрэглэх учраас Factor-г нягтлах ажиллагаа хэрэггүй.

<Factor-г тодорхойлох тохиолдолд стандартчилал тогтоохын тулд дараах уусмалуудыг ашиглана >

- ① Bromophenol blue ② NaCO₃ (Sodium carbonate / anhydrous)

Стандарт тогтоох аргачлалыг JIS K0103-н p.905-хуудаст бичсэн байгаа.

4.1.2 Preparation of Arsenazo III Solution

Arsenazo III 0.2g-г микро жинлүүрээр хэмжин авч, Deionized water 100ml-г нэмж сайтар сэгсэрч холино. Уусгасаны дараа хүрэн өнгийн шилэн саванд хийж хадгална. Хадгалах

SOx Analysis for Stack Monitoring

Measurement method: Precipitation Titrimetry (Arsenazo III)

хугацаа 1 сар.

4.1.3 Preparation of 5 m mol/L Barium Acetate Solution

$$\text{Ba}(\text{OCOCH}_3)_2 \quad 1.1\text{g}$$

$$\text{Pb}(\text{OCOCH}_3)_2 \cdot 3\text{H}_2\text{O} \quad 0.4\text{g}$$

Deionized water 200ml

Add CH_3COOH 3ml

Fill the flask up to **1000 ml** gauge line with 2-propanol

Бэлдсэн «Barium Acetate» -н уусмалын агууламжийг дараах дараах пепитикээр хэмжиж гаргана.

-----①~④-г бэлдэж 200ml Flask-г хийх. -----

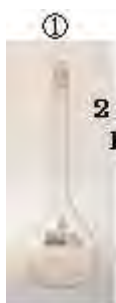

10ml
Pipette-р нарийн зөв хэмжиж авах



40 ml

- ③ CH_3COOH 1ml
- ④ Arsenazo III Solution
4~6 дусал



200 ml flask

< Titration-р В (Barium Acetate) -н агууламжийг тодорхойлох.

5ml-н Micro bullet-г ашиглана.

Уусмалын цэнхэр өнгийг 1 минутын хугацаанд ажиглана.

В-н орсон хэмжээг унших.

Дараах томъёогоор F-г тодорхойлно.

$$F = \frac{10 \times f}{a} \times \frac{2}{5}$$

Where;

F ; 5 m mol/L Barium Acetate-н Factor

f ; 2 m mol/L H_2SO_4 -н Factor

a ; Пепитикээр хийсэн В-н хэмжээ (ml)



SO_x Analysis for Stack Monitoring

Measurement method: Precipitation Titrimetry (Arsenazo III)

4.2 Determination of the Sample Concentration

4.2.1 Sample Conditioning

Бэлдсэн дээжээ 250ml Flask-т шилжүүлэн хийнэ.

Ионжуулсан усаар угааж үлдэгдэл уусмалыг бүгдийг нь шилжүүлэн хийнэ.



Fill the flask up to 250 ml gauge line with deionized water

-----Дараах 4 уусмалыг 200ml Flask-т хийнэ. -----



Дээж 10ml



40 ml

③ CH₃COOH 1ml

④ Arsenazo III Solution

4~6 дусал



200 ml flask

-----Дээжийг Barium Acetate Solution (B)-р дусал дулаар хийх. -----

Уусмалын цэнхэр өнгийг 1 минутын хугацаанд ажиглана.

B-н хэрэглэсэн хэмжээг уншиж тэмдэглэнэ.

(a ml болгох.)



SO_x Analysis for Stack Monitoring

Measurement method; Precipitation Titrimetry (Arsenazo III)

-----Blank-г Barium Acetate Solution (B)-р пепиткээр хийнэ.-----

(Шингээгч уусмалд орсон байх магадлалтай өчүүхэн хэмжээний SO_x-н агууламжийг хэмжих.)

Шингээгч уусмал (Absorbing Solution)
100ml-г 250ml Flask-д хийн ионжуулсан
усаар шингэрүүлнэ.



Fill the flask up to 250 ml gauge line
with deionized water

-----Дараах 4 уусмалыг 200ml Flask-т хийнэ.-----



Blank 10ml



40 ml

- ③ CH₃COOH 1ml
④ Arsenazo III Solution
4~6 дусал



200 ml flask

Микро пепитка ашиглан шингэний цэнхэр өнгийг 1 минутын хугацаанд ажиглана.

B-н хэрэглэсэн хэмжээг уншиж, тэмдэглэнэ.

(**b** ml болгох)



Энэхүү хаягдал уусмалд хар тугалга болон хүнцэл агуулагдаж буй тул устгал хийхдээ анхаарах хэрэгтэй.

SO_x Analysis for Stack Monitoring

Measurement method: Precipitation Titrimetry (Arsenazo III)

5. Дээжийн агууламжийн тооцоо

Дээжинд агуулагдах SO_x (Sulfur Oxides)-н эзэлэхүүн (Volppm)-г дараах томъёогоор тооцоолж гаргана.

$$C_v = \frac{0.112 \times (a - b) \times F \times 250 / 10}{V_s} \times 1000 \text{ (Volppm)}$$

Хэрвээ SO_x-г SO₂-р тооцож, мөн түүнийг жингээр илэрхийлэх тохиолдолд дараах томъёог ашиглана.

$$C_w = \frac{0.320 \times (a - b) \times F \times 250 / 10}{V_s} \times 1000 \text{ (mg/m}^3 \text{ N)}$$

Where;

C_v : Дээжинд агуулагдах SO_x-н эзэлэхүүн (Volppm)

C_w : Дээжинд агуулагдах SO_x-г SO₂-р илэрхийлэх үеийн масс (mg/m³ N)

a ; Дээжинд ашигласан 5 m mol/L Barium Acetate-н хэмжээ (ml)

b ; Blank-г хийхэд ашигласан 5 m mol/L Barium Acetate-н хэмжээ (ml)

F ; 5 m mol/L Barium Acetate-н Factor

V_s; Дээж хийн эзэлэхүүн (Хэвийн нөхцөл рүү шилжүүлсэний дараах) (L_N)

0.112 ; 5 m mol/L Barium Acetate-т тохирох SO_x-н Хэвийн нөхцөл дэх эзэлэхүүн (ml)

0.320 ; 5 m mol/L Barium Acetate-т тохирох SO₂-н бодит масс.(mg)

1. Outline of NOx gas Analysis for Stack Monitoring

1.1 Gas Sampling

Вакуум шилэн савыг ашиглан хаягдал утаанаас дээж авна.

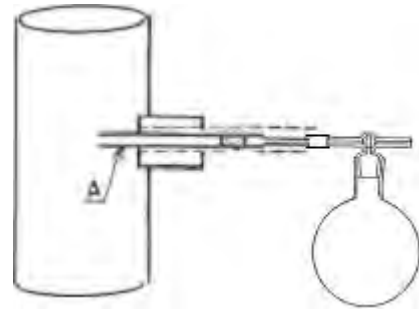

1.2 Analysis Method

NEDA (Naphthyl ethylenediamine absorptiometry) by Absorption Spectrometer

Дээжилж авсан хаягдал утаан дахь NOx-ийн агууламжийг фото спектрометр ашиглан хэмжинэ.



2. Preparation

2.1 Absorbing Solution

Хаягдал утаан дахь NOx-ийг шингээх 2 төрлийн уусмал (A болон B) бэлдэнэ.

Reagent		
1. $\text{CuSO}_4 \cdot 5\text{H}_2\text{O}$	(Copper Sulfate Pentahydrate)	500g bottle
2. NaOH	(Sodium Hydroxide)	500g bottle
3. Na_2CO_3	(Sodium Carbonate)	500g bottle
4. NaCOOH	(Sodium Formate)	500g bottle

< A solution >

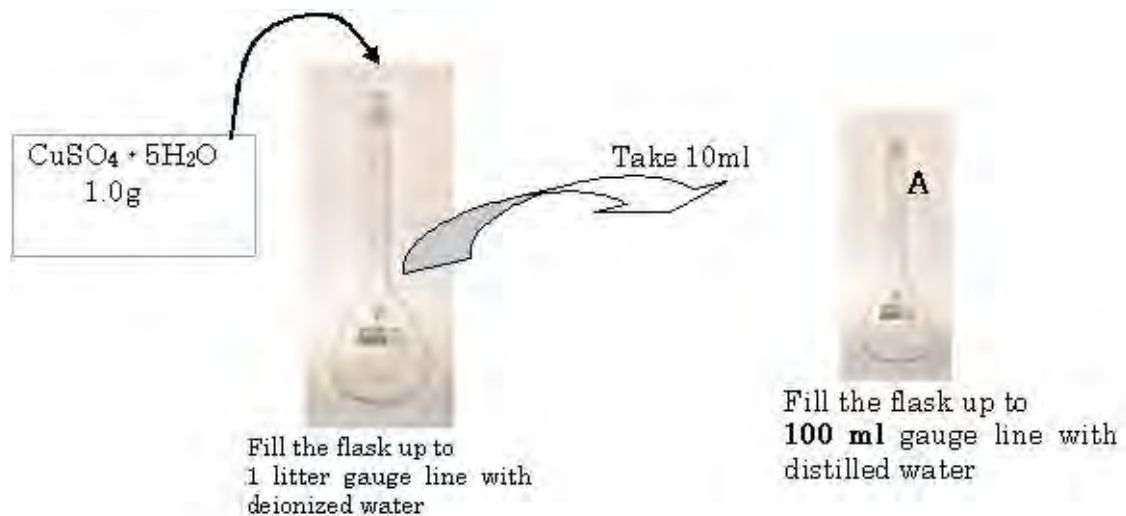

< B solution >

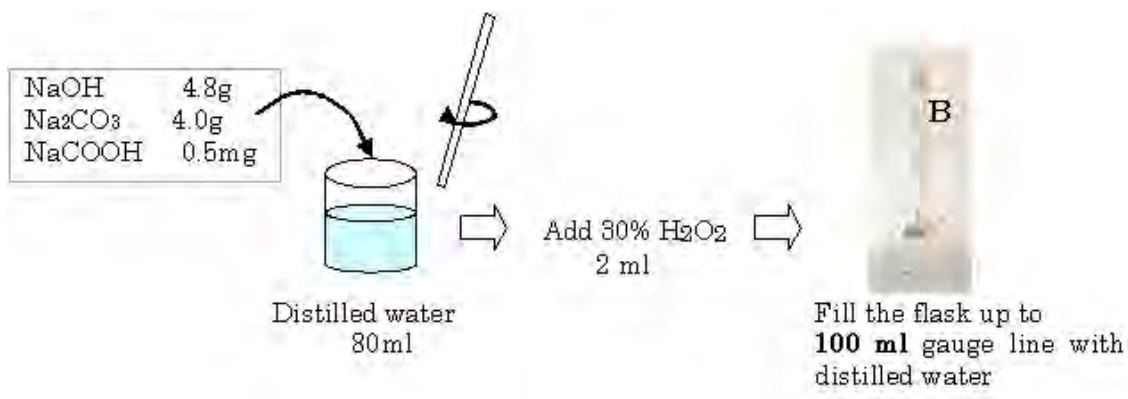

2.2 Sufanilamide HCl Solution

200мл-ийн шилэн саванд 50 мл нэрмэл ус хийн, 1,0 г Sufanilamide-ийг уусгана. Улмаар 112 мл давсны хүчил нэмсний дараа зураас хүртэл нэрмэл ус нэмнэ.

2.3 Naphthylethylenediamine Solution

N-1- naphthylethylenediamine dihydrochloride 0.1г-ийг 100 мл нэрмэл уусанд уусгана.

2.4 NO₂⁻ Standard Solution (100mg NO₂⁻/L)

1000 мг NO₂⁻/L стандарт уусмал (500мл-ийн шил)-аас 10 мл-ийг аван, 100 мл-ийн шилэн саванд хийн, зураас хүртэл нэрмэл ус нэмнэ.

2.5 Gas Sampling Flask

Хаягдал хийн дээж авахад вакуум шилэн сав (1.2 л-ийн багтаамжтай)-ыг ашиглана. Насосоор шилэн саван дахь агаарыг сорж аван, вакуумжуулан бэлдэж, хэмжилтийн талбай руу авч явах. (Энэ аргачлалд шилэн саванд урьдчилан гэрэл шингээлтийн бодис хийх шаардлагагүй.)

2.5.1 Шилэн савыг вакуумжуулах

Хамгийн багадаа 2 вакуум шилэн сав бэлтгэнэ. Жижиг оврын насос ашиглан шилэн савыг агааргүй болгоно. Тагтай болгоомжтой харьцах.





2.5.2 Шилэн савны дотор даралт, орчны температурыг хэмжих

Даралт хэмжигч болон температур хэмжигч ашиглан, вакуумжуулсан шилэн савны дотор даралт (дээж авахаас өмнөх): P_i (kPa), болон орчны температур (дээж авахаас өмнөх): T_i ($^{\circ}\text{C}$)-ийг тэмдэглэж авна. Вакуум шилэн сав тус бүрийг хэмжин тэмдэглэж авна.



3. Gas Sample Collection at Monitoring Site

Шилэн саван дахь вакуум орчныг ашиглан, дараах дарааллын дагуу хоолой дахь хаягдал утааг богино хугацаанд шилэн саванд соруулан, дээж авна (хэмжилтийн талбай дахь ажил).

- 1) Зургийн дагуу дээж авах төхөөрөмжийг хоолойд суурьлуулна. Дээж авах төхөөрөмжинд хийн алдагдал байж болохгүй. Дээжний тоо (шилэн савны тоо) нь 2-оос дээш байх.
- 2) Гар насосоор дээж авах хоолой болон вакуумжуулсан шилэн савны холбогдсон хэсгийг хаягдал утаагаар солино. (Вакуумжуулсан шилэн савны дээд талын таглааны чиглэлийг анхаарах) 
- 3) Тагыг тохируулан, вакуумж шилэн саванд хаягдал утааг соруулна. 

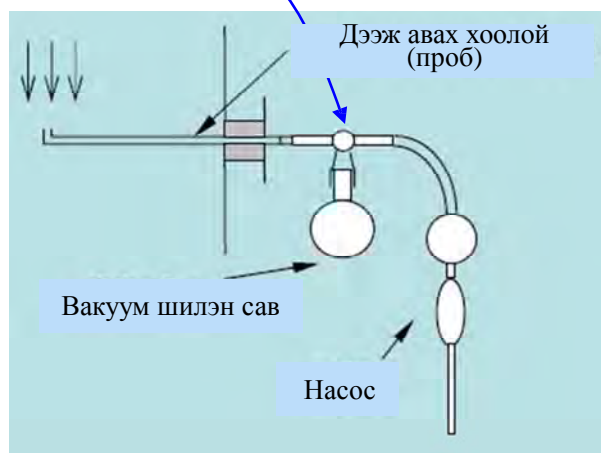

- 4) Дээж авсны дараа 2.5.2-т бичсэний дагуу шилэн савны дотор даралт болон орчны температурыг хэмжин тэмдэглэнэ.

Шилэн саван дахь дотоод даралт (дээж авсаны дараа): P_f (kPa), орчны температур (дээж авсаны дараа): T_f ($^{\circ}\text{C}$)-ийг вакуумжуулсан шилэн сав тус бүрээр тэмдэглэнэ.

- 5) 100 мл-ийн шприцэд А уусмалаас 5 мл, В уусмалаас 50 мл-ийг хийнэ. Шприцэнд агаар үлдээхгүй байх.

(Шүлтлэг уусмалаас гараа хамгаалахын тулд резинэн бээлий өмсөнө.)

- 6) Хаягдал утааг вакуум шилэн саванд дээж авангуутаа (5 минутын дотор), (зургийн дагуу) шприцийг вакуум шилэн саванд холбон, уусмалыг вакуум шилэн саванд хийнэ. (Тагны чиглэлийг анхаарах)



(Энэ ажиллагааг хэмжилтийн талбайд хийнэ.)

Шахаж дууссангуут шприцийг салган шууд тагыг таглана. 

- 7) Хоёр гараараа шилэн саваа барин, тэр даруйдаа 3 минутийн турш шилэн савыг хүчтэй сэгсэрнэ. Ингээд хаягдал утаан дахь NOx нь шингээлтийн уусмалд шингэнэ. Хэмжилтийн талбай дахь ажиллагаа дуусна.

4. Analysis by Absorption Spectrophotometer

4.1 Preparation of Making a New Standard Curve for NO_x Analysis

2.4-ийн дагуу бэлтгэсэн NO₂⁻ Standard Solution (100mg NO₂⁻/L) ийн шилэн савнаас 1 ~5 мл-ыг дэс дараатайгаар аван, 100мл-ийн шилэн саванд хийнэ.

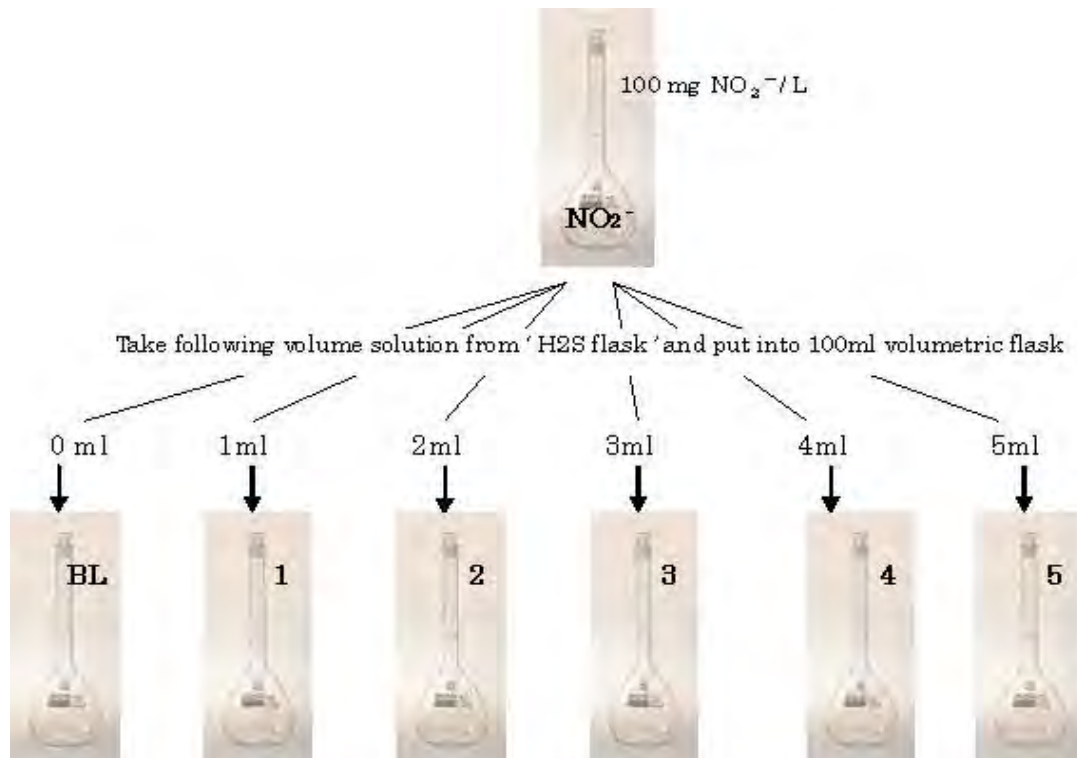

Цэвэрлэсэн 6 ширхэг шилэн колб бэлдэнэ. Тус бүрд (хаягдал утаа биш өрөөний агаартай) §3-ийн 5), 6), 7) үйлдлийг хийнэ.

Түүний дараа 6 шилэн колб дахь уусмал тус бүрийг [0~5] дугаарын 100мл-ийн шилэн колб руу бүгдийг шилжүүлнэ.

Шилжүүлсэний дараа улмаар вакуум шилэн савыг ойролцоогоор 15мл-ийн усаар 2 удаа зайлан угаана. Энэ угаасан шингэнээ мөн 100 мл-ийн шилэн саванд шилжүүлнэ. (Бүх вакуум шилэн савыг угаан шилжүүлэх.)



4.2 Дээжийг солих

§ 3-ийн 7) хүртэлх ажиллагаагаар хэмжилтийн талбай дээр авсан дээжийн хувьд ч дээрх ажиллагаатай адилаар 100 мл-ийн шилэн саванд шилжүүлнэ.

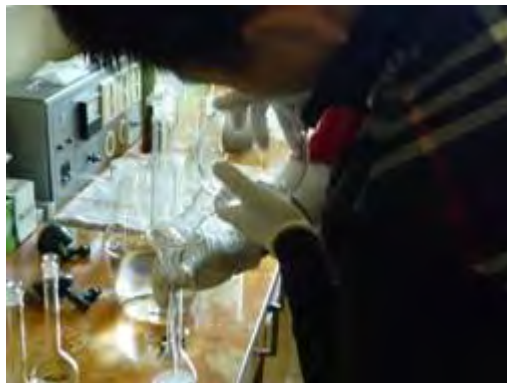
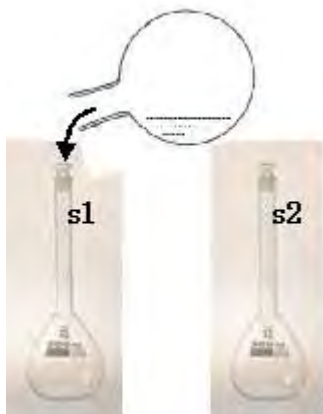

4.3 Дээжийг халаах болон хөргөх

Халуун хадгалагчид ус хийн, тохируулгыг 80°C-т тохируулна.

4.1, 4.2-оор бэлтгэсэн «Blank, 1~5, дээж»-ийн бүх шилэн савны тагыг нээн тэдгээрийг 80°C-ийн халуун усанд хийн, 30 минут байлгана. (Хий ихээр гадагшлана).

30 минутын дараа халуун хадгалагчаас гарган шилэн савны гаднаас крантны хүйтэн ус гоожуулан шилэн савны температурыг бууруулна.

Тасалгааны хэм хүртэл буурсаны дараа зураас хүртэл нэрмэл ус хийнэ. Дараа нь таглан бага зэрэг сэгсэрнэ. Үүнийгээ дүн шинжилгээний дээж уусмал болгон ашиглана.



5. Өнгө орох / гэрэл шингээх эрчим хэмжих

100 мл-ийн 8 шинэ шилэн сав бэлдэнэ.

Халаасан эсвэл хөргөсөн дүн шинжилгээний дээж уусмалаас тус бүр 20 мл-ийг аван, 100 мл-ийн шинэ шилэн саванд шилжүүлнэ.

Улмаар дараах уусмалыг шилэн сав тус бүрт нэмнэ.

- ① 2.2 - т хийсэн Sufanilamide HCl Solution-ийг 10 мл
- ② 2.3-г хийсэн Naphthylethylenediamine Solution-ийг 5 мл

Түүнийхээ дараа нэрмэл усыг зураас хүртэл нэмэн, таглан сайтар сэгсэрнэ. Улмаар тасалгааны хэм (15~30°C)-д ойролцоогоор 15 минут байлган, гэрэл шингээлтийн эрчим хэмжигч (долгионы урт 545 нм)-ээр гэрлийн шингээх эрчмийг хэмжинэ.

Халаасан, хөргөсөн дээж

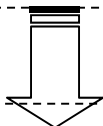
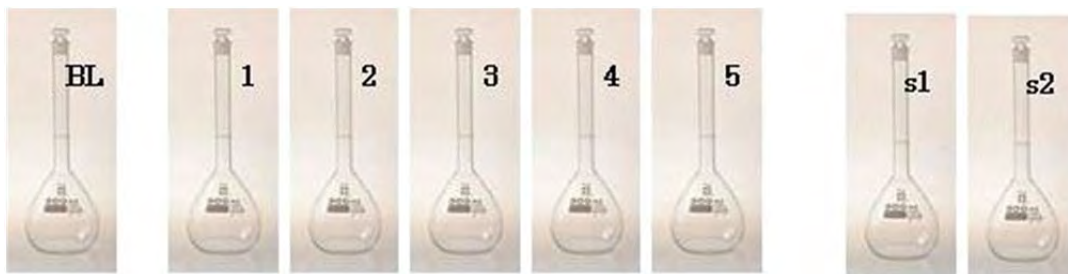

Гэрэл шингээх эрчим хэмжигчээр дүн шинжилгээ хийх дээж



6. Determination of the sample concentration

Хаягдал утааны дээжийн эзлэхүүн болон шингээгч бодисонд шингэсэн NO₂-ийн массаар хаягдал утаан дахь азотын ислүүдийн агууламжийг тооцоолж болно.

6.1 Хаягдал утааны дээжний эзлэхүүнийг тооцоолон гаргах

Хуурай хийн эзлэхүүн (Dry gas volume)-ийг дараах томъёогоор тооцоолно.

$$V_{SD} = V_a \times \frac{273.15}{101.32} \times \left[\frac{P_f - P_{nf}}{273.15 + t_f} - \frac{P_i}{273.15 + t_i} \right] \quad (\text{ml})$$

Where,

V_{SD} ; Хуурай хийн эзлэхүүн (мл)

V_a ; Вакуум шилэн савын эзлэхүүн (мл) (шилэн сав тус бүрийн гадна бичигдсэн хэмжээс)

P_f ; Дээж хийг авсаны дараа хэмжсэн вакуум шилэн савны дотор даралт (кПа)

P_{nf} ; t_f -ийн ханасан усны уурын даралт (кПа)

P_i ; Дээж хийг авахаас өмнө хэмжсэн вакуум шилэн савны дотор даралт (кПа)

t_i ; P_i -ийг хэмжсэн үеийн орчны агаарын хэм ($^{\circ}\text{C}$)

t_f ; P_f -ийг хэмжсэн үеийн орчны агаарын хэм ($^{\circ}\text{C}$)

6.2 Хаягдал утаан дахь азотын ислүүдийн агууламж (Хуурай хийн дэх агууламж)

$$C_V = \frac{0.487 \times V}{V_{SD}} \times \frac{100}{20} \times 10^6 \quad (\text{volppm})$$

$$C_W = \frac{V}{V_{SD}} \times \frac{100}{20} \times 10^6 \quad (\text{mg/m}^3)$$

Where,

C_V ; Дээж хийн дэх азотын ислүүдийн эзлэхүүний агууламж (volppm)

C_W ; Дээж хийн дэх азотын ислүүдийн массын агууламж (mg/m^3)

V ; Дээжийн гэрэл шингээх эрчимд дүн шинжилгээ хийсэн дүн. Дүн шинжилгээний муруйгаас тооцоолсон азотын давхар ислийн масс (мг)

20 ; Дүн шинжилгээний дээжийн уусмалын хэмжээ (мл)

0.487 ; Азотын давхар исэл 1мг-тай тэнцэх азотын давхар ислийн эзлэхүүн (мл)

Appendix2.2-2 List of HOB Setting Sampling Hole

Сорьцийн цэг суурьлагдсан зуух (1 дэх жил) Нийт 20 газар

NO.	Owners / Users / Location	Country	Type	Capacity MW	Stack Type	Latitude	Longitude
1	#113 Secondary School / Bayangol Dist.	Mongolia	MDZ-0.25	0.25	Steel Pipe	47.92609	106.86626
2	#46 School / Bayangol Dist., West Side of Mongol TV	China	KCR-300	0.7	Steel Pipe	47.930738	106.887426
3	Mental Hospital / Bayanzurkh Dist.	Mongolia	BZUI-100	0.85	Steel Pipe	47.932038	107.011396
4	Mental Hospital / Bayanzurkh Dist.	Mongolia Mongolia	HP-18-27	0.2	Steel Pipe	47.932133	107.01125
5	Auto Hall / Bayanzurkh Dist.	Mongolia	HP25J	Unknown	Steel Pipe	47.92476	106.98843
6	EcoHangul / #92 Secondary School / Bayanzurkh Dist.	Mongolia	MDZ-063	0.63	Steel Pipe	47.918456	106.997397
7	Tushigtkhovei LLC / #41 Secondary School /	Hungary	Carborobot 300	0.3	Steel Pipe	47.870604	106.81838
8	Tushigtkhovei LLC / #41 Secondary School /	Russia	MUHT	0.7	Brick	47.870607	106.818434
9	RVR / #10 Secondary School	Mongolia	MWB	1	Brick	47.752037	106.564608
10	#104 School / Songino Khairhan Dist.	China	WWGS-0.35	0.35	Concrete	47.967374	106.830493
11	"Erdenesuvraga"Co. Ltd. / #39 School	China	DZL 1.4	1.4	Steel Pipe	47.935861	106.906011
12	Rescue Force Residence / Songino Khairhan Dist.	Mongolia	HP-30J	0.18	Steel Pipe	47.91349	106.74569
13	Bosa Shopping Center, etc. / Bayanzurkh Dist.	Mongolia	RJG-18	Unknown	Steel Pipe	47.90828	107.01172
14	Tavan gan / Building of rental rooms, Pasta Production Factory / Bayanzurkh Dist.	China	CLSG25	0.25	Steel Pipe	47.91621	106.99145
15	MCS Tiger beer	China	DZL 4	4	Steel Pipe	47.9057	107.02302
16	Coca Cola	China	DZL 6	6	Steel Pipe	47.907511	107.022238
17	Burd Center / Shukhbaatar Dist	China	LSG-0.20	0.2	Steel Pipe	47.93979	106.91727
18	#71 School / Shukhbaatar Dist.	China	CWNG-0.35	0.35	Concrete	47.99778	106.97011
19	#106 School / Songino Khairhan Dist.	Mongolia	Thermochlor-0.3	0.35	Concrete	47.91985	106.75085
20	Tenger Sudar LLC / Shukhbaatar Dist.	Mongolia	Hand Made	Unknown	Steel Pipe	47.968222	106.930212

Сорьцийн цэг суурьлагдсан зуух (2 дэх жил) Нийт 35 газар

Report Name	Boiler House				НОВ				
	No	Name	District	Khoroo	No	Model	Country	Installed Year	Capacity (kW)
58-р сургууль	81	58-р сургуулийн халаалтын зуух	СҮХБААТАР	15-р хороо	1	МУХТ	МОНГОЛ	2011	810
					2	МУХТ	МОНГОЛ	2011	810
61-р сургууль 1	51	61-р сургуулийн халаалтын зуух	ЧИНГЭЛТЭЙ	12-р хороо	1	Китирами	Солонгос	2011	350
61-р сургууль 2					2	Китирами	Солонгос	2011	350
76-р сургууль	95	76-р сургуулийн халаалтын зуухны газар	СОНГИНОХАЙРХАН	9-р хороо	1	БЗУИ-100А	МОНГОЛ	2010	810
					2	БЗУИ-100А	МОНГОЛ	2010	810
					3	ЭКО-500	МОНГОЛ	2007	500
					4	ЭКО-500	МОНГОЛ	2007	500
79-р сургууль	23	79-р сургуулийн (бага) халаалтын зуух	БАЯНЗҮРХ	9-р хороо	1	CARBOROBOT	УНГАР	2010	180
102-р сургууль 1	20	102-р сургуулийн халаалтын зуух	БАЯНЗҮРХ	21-р хороо	1	MDZ	МОНГОЛ	2007	250
					2	MDZ	МОНГОЛ	2007	250
117-р сургууль	41	117-р сургуулийн халаалтын зуух	ЧИНГЭЛТЭЙ	18-р хороо	1	НР-30Ж	МОНГОЛ	2009	244
					2	НР-30Ж	МОНГОЛ	2009	244
118-р сургууль		118-р сургууль	ХАНУУЛ		1	CARBOROBOT	УНГАР	2011	
					2	CARBOROBOT	УНГАР	2011	
Онцгой байдил 1	99	Аврах тусгай ангийн халаалтын зуухны газар	СОНГИНОХАЙРХАН	21-р хороо	1	CLSG	БНХАУ	2006	300-400
Гэгээ хотхон	33	Гэгээ хотхоны халаалтын зуух	БАЯНЗҮРХ	5-р хороо	1	MDZ	МОНГОЛ УЛС, МОНДУЛААН Т РЭЙЛ ХХК	2007	250
59-р сургууль	56	59-р сургуулийн халаалтын зуух	ХАНУУЛ	14-р хороо	1	MDZ	МОНГОЛ	2006	63
					2	MDZ	МОНГОЛ	2006	63
Төмөр зам ПДМС	37	Амгалан дахь УБТЗ Хангах баазын халаалтын зүүх	БАЯНЗҮРХ	10-р хороо	1	НР-18-54	МОНГОЛ	2007	500
					2	НР-18-54	МОНГОЛ	2007	500
					3	НР-18-54	МОНГОЛ	2007	500
Түшигт хангай 1	61	41-р сургуулийн халаалтын зуух	ХАНУУЛ	5-р хороо	1	МУХТ-1,2	МОНГОЛ	2010	1200
					2	КВ3-06	ОХУ	2009	600
Хаан Банк									
Түшигт хангай Хонхор	18	Түшигтхангай ХХК 88-р сургуулийн Усан халаалтын /30-р/ зүүх	БАЯНЗҮРХ	11-р хороо	1	КВ3-06	ОХУ	2007	600
					2	КВ3-06	ОХУ	2007	600
Хүүхдийн эмнэлэг	69	Нэгдсэн эмнэлэг	ХАНУУЛ	4-р хороо	1	Карборобот	УНГАР	2009	300
					2	Карборобот	УНГАР	2009	300
					3	Карборобот	УНГАР	2009	300
Хүчит шонхор	50	Хүчит шонхор ХХК-ий халаалтын зуух	ЧИНГЭЛТЭЙ	11-р хороо	1	МОНДУЛААН	Монгол	2005	300
					2	МОНДУЛААН	МОНГОЛ	2005	300
Их засаг 1 Их засаг 2	21	ИЗИС-ийн халаалтын зуух	БАЯНЗҮРХ	4-р хороо	1	DZL 700	БНХАУ	2011	700
					2	DZL 1400	БНХАУ	2006	1400
					3	CLSG-0,24	БНХАУ	2004	240
Экологийн хүрээлэн	83	Дулааны хүрээлэн ШУТИС	СҮХБААТАР	16-р хороо	1	ДТХ-0,3	МОНГОЛ	2007	350
60-р сургууль 1	60	Түшиг хангай ХХК-ий УХ-ын 60-р сургуулийн зүүх	ХАНУУЛ	7-р хороо	6	МУХТ-1,2	МОНГОЛ	2010	1200
Хоёулаа хүү	4	Жанжин клубын халаалтын зуухны газар /10-р зүүх/	БАЯНЗҮРХ	12-р хороо	1	Карборобот 140	УНГАР	2006	140
					2	НР-18/54	МОНГОЛ	2001	400-500
60-р сургууль 2	60	Түшиг хангай ХХК-ий УХ-ын 60-р сургуулийн зүүх	ХАНУУЛ	7-р хороо	6	МУХТ-1,2	МОНГОЛ	2010	1200
Онцгой байдал 2	99	Аврах тусгай ангийн халаалтын зуухны газар	СОНГИНОХАЙРХАН	21-р хороо	1	CLSG	БНХАУ	2006	300-400
102-р сургууль 2	20	102-р сургуулийн халаалтын зуух	БАЯНЗҮРХ	21-р хороо	1	MDZ	МОНГОЛ	2007	250
					2	MDZ	МОНГОЛ	2007	250
105-р сургууль	103	105-р сургуулийн халаалтын зуухны газар	СОНГИНОХАЙРХАН	11-р хороо	1	VIADRUS-VSB15	МОНГОЛ	2006	390
					2	VIADRUS-VSB15	МОНГОЛ	2006	390
					3	VIADRUS-VSB15	МОНГОЛ	2006	390
					4	VIADRUS-VSB15	МОНГОЛ	2006	390
Жасмин 85-р сургууль	19	Оргихийн булаг ХХК Түшигтхангай ХХК 85-р сургуулийн Усан халаалтын / 23-р/ зүүх	СҮХБААТАР	20-р хороо	1	МУХТ-1,2	МОНГОЛ	2008	1200
					2	КВ3-06	ОХУ	2007	600
Очир ундраа Бөхөг			СҮХБААТАР	12-р хороо		GZZZ			
УС-15	74	Бөхөг ХХК халаалтын зуухны газар	ХАНУУЛ	13-р хороо	1	CLSG	БНХАУ		920
УС-15	13	УС 15 халаалтын зуухны газар	БАЯНЗҮРХ	8-р хороо	1	БЗУИ-100	МОНГОЛ	1980	810
					2	БЗУИ-100	МОНГОЛ	1980	810
Авто төв			БАЯНЗҮРХ	19-р хороо		НР30Ж	МОНГОЛ		244
104 – сургууль	96	104-р сургуулийн халаалтын зуух	СОНГИНОХАЙРХАН	21-р хороо	1	CMNG-0,35	БНХАУ	2007	400
63-р сургууль	68	ХУД-ийн 63-р тусгай сургуулийн халаалтын зүүх	ХАНУУЛ	4-р хороо	1	БНЭБ	МОНГОЛ	2007	250
Дорнын илч ХХК						МУХТ-0.07	МОНГОЛ		

Тайлбар : Утаа шүүгч төхөөрөмжийн оролт болон гаралт тус бүрт хэмжилт хийх зорилгоор 1 зууханд хэд хэдэн сорьцийн цэг суурьлуулсан тохиолдол байгаа.

Сорьцийн цэг суурьлуулалтын тайлан
測定孔設置の報告書



58-р сургууль
第58学校



61-р сургууль 1
第61学校①



61-р сургууль 1
第61学校②



76-р сургууль
第76学校



79-р сургууль
第79学校



102-р сургууль 1
第102学校①



117-р сургууль
第117学校



118-р сургууль
第118学校

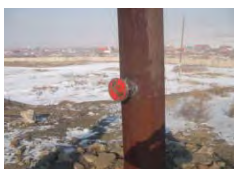

Онцгой байдл 1
緊急災害対策本部①



Гэгээ хотхон
ベロン



59-р сургууль
第59学校



Төмөр зам ПДМС
鉄道修理場

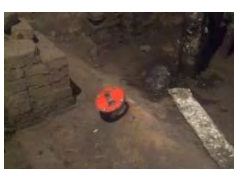

Түшигт хангай 1
Tushig Khangai①



Хаан Банк
Khaan銀行



Түшигт хангай Хонхор
Tushig Khangaiホンホル地域



Хүүхдийн эмнэлэг
子供病院



Хүчин шонхор
バザール



Их засаг 1
Ikh zasag大学①



Их засаг 2
Ikh zasag大学②



Экологийн хүрээлэн
エコロジー研究所



60-р сургууль 1
第60学校①



Хоёулаа хүү
Khooyulaa khuu



60-р сургууль 2
第60学校②



Онцгой байдал 2
緊急災害対策本部②



102-р сургууль 2
第102学校②



105-р сургууль
第105学校



Жасмин
Jasmin



85-р сургууль
第85学校

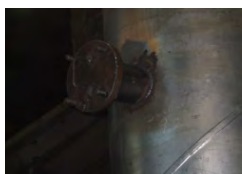

Очир ундраа

Ochir Undraa



Бөхөг

Bukhug



УС-15

US-15



Авто төв

Auto Hall



104 – сургууль

第104学校



63-р сургууль

第63学校



Дорнын илч ХХК

Dorniin ilch有限公司

※ 全35箇所にて測定孔の設置を行いました。

Dorniin Ilch有限公司

2012年1月10日

Appendix2.2-3 Specification of Flange Making, Specification of Sampling Hole and Drawing of Flange and Specification of Flange Installation for Stack Gas Measurement

Утааны хийн хэмжилтийн зориулалттай фланец хийх ажиллагааны даалгавар

1. Утааны хэмжилтийн фланец хийх зорилго

Утааны хэмжилтийн зориулалттай фланец хийх зорилго нь УБ хот орчмын УХЗ-аас гарч байгаа утааны бохирдуулагч бодисын агууламжийг хэмжих багажийг яндан руу шургуулах хэмжилтийн зориулалттай сорьцын цэг гаргахад оршино.

2. Гүйцэтгүүлэх агуулга

2.1 Утааны хэмжилтийн зориулалттай фланец хийх

Гүйцэтгэгч нь утааны хэмжилтийн фланец хийж бэлтгэнэ.

(1) Хийх тоо ширхэг

24 ширхэг (Ангилал ; Фланжны урт 15см х 12 ширхэг, 20см х 6 ширхэг, 50см х 6 ширхэг)

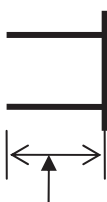

Фланецны хоолойн урт

(2) Гэрээт хугацаа

Гэрээт өдрөөс ~2010 он 9 сар 3 өдөр

Утааны хэмжилтийн зориулалттай фланецийг хийх

Гүйцэтгэгч нь хавсралтын зурганд үзүүлэх фланецийг хийж гүйцэтгэнэ.

Хийцийн агуулга

- ① Гадна диаметр нь 80~100мм- тэй төмөр трубааг 150~500мм-ээр таслана.
- ② Турбаны нэг талд нь, 5к тэгшилсэн трубаан гадна диаметрээр тааруулан фланец гагнаж өгнө.
- ③ Фланецны хэмжээгээр халуун паранит бэлтгэнэ.
- ④ Фланецтай адил хэмжээ бүхий төмөр хавтан зүсэж тааруулан фланецны нүхтэй адил хэмжээнд нүхэлсэн таг хийнэ.
- ⑤ Фланжны боолтны нүхэнд таарах боолт (14~18ммφ-ийн боолт) болон гайкнуудийг боолтны нүхний тоогоор бэлдэнэ.
- ⑥ Хавсралт зургийн дагуу угсарна.

(3) Хийх төлөвлөгөөний шийдэл

Гүйцэтгэгч нь доорхи зүйлсийг хамруулсан гүйцэтгэлийн төлөвлөгөөг гаргаж захиалагчид хүргүүлнэ.

- Гүйцэтгэлийн явцын хүснэгт
- Бүтээмжийн зохион байгуулалтын хүснэгт (Ажлын хэсгийн бүдүүвч • агуулга болон хариуцагч)
- Бусад хэрэгтэй гэсэн зүйл

(4) Ажил үүргийн хяналт

- Гүйцэтгэгч нь захиалагчтай холбоотойгоор ажлыг явуулна.

(5) Зардлын зохицуулалт

Утааны хэмжилтийн зориулалттай фланж хийхэд шаардлагатай хүн хүч, материал, бусад зарцуулах материалын зардлыг гүйцэтгэгч тал бүрэн хариуцна.

2.2 Эргэлзээ

Гүйцэтгэгч нь ажил гүйцэтгэлийн явцад эргэлзээ үүссэн тохиолдолд захиалагчтай зөвшилцний үндсэн дээр гүйцэтгэнэ.

2.3 Бэлэн болсон бүтээгдхүүн

- Гүйцэтгэгч нь бүтээгдхүүнийг хүргүүлж өгч захиалагчаар шалгуулан зөвшөөрүүлсэн байх.
- Бүтээгдхүүн нь захиалагчийн заасан газарт гүйцэтгэгч нь хүргэж өгсөн байх.

Drawing of Flange for Flue Gas Measurement

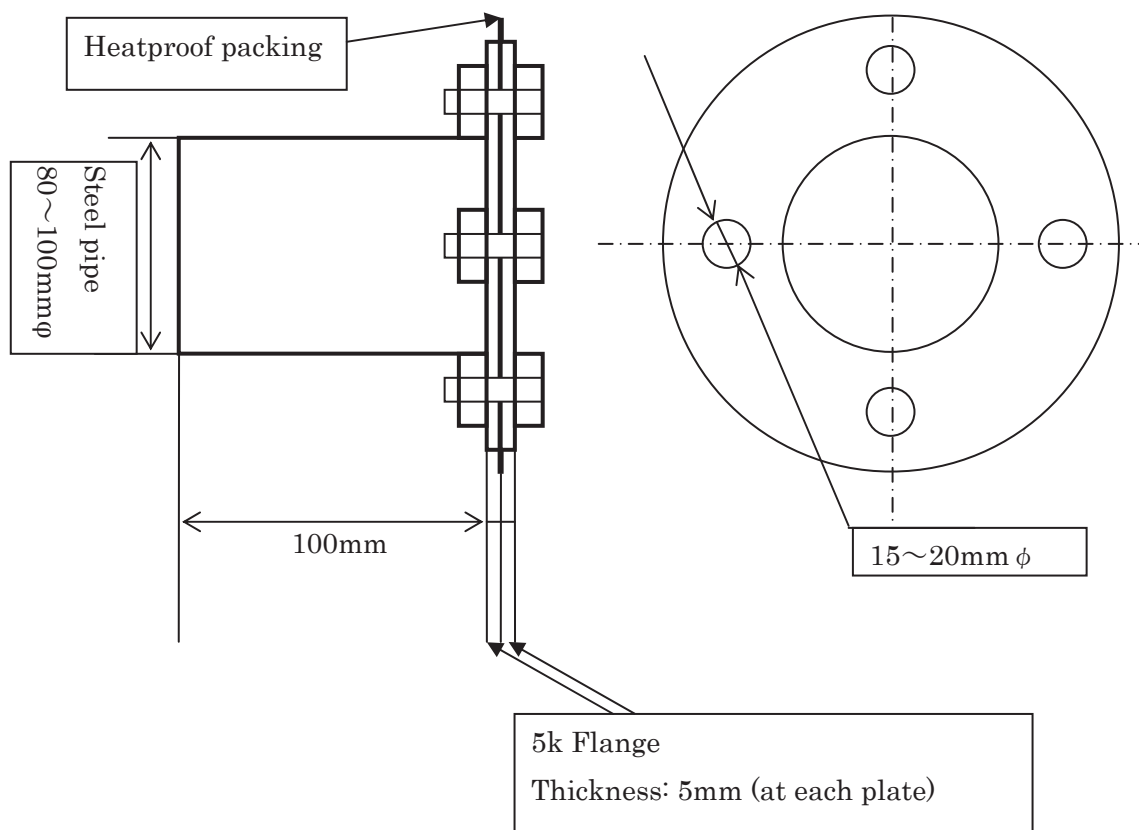

Remarks

In the case of concrete or brick stack:

Length of flanges have to be decided based upon the thickness of the each stack wall after making a hole there. And flanges have to be installed as shown in the drawing below.

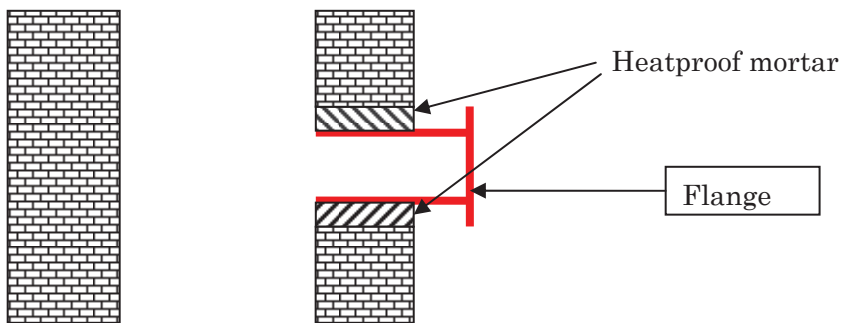

Fig. Cross Section of stack made of brick or concrete

Утааны хэмжилтийн зориулалттай фланж суурьлуулах ажиллагааг гүйцэтгүүлэх ажлын даалгавар

1. Утааны хэмжилтийн фланц суурилуулах зорилго

Утааны хэмжилтийн фланц суурилуулах зорилго нь УБ хотод байгаа УХЗ-аас гарч буй хаягдал хий утаан дахь бохирдуулах бодисын агууламжийг хэмжихийн тулд багаж төхөөрөмжийг яндан руу оруулах хэмжилтийн нүх гаргахад оршино.

2. Гүйцэтгүүлэх ажлын агуулга

2.1 Утааны хэмжилтийн зориулалттай фланцны суурилуулалт

Гүйцэтгэгч нь УБ хотын доторх захиалагчийн товлосон УХЗ-ны яндан эсвэл утааны замд хэмжилтийн зориулалттай фланцийг суурилуулалтыг хийнэ.

(1) Үйл ажиллагааны нутаг дэвсгэр

Улаанбаатар хот

(2) Гэрээт хугацаа

Гэрээ хийсэн өдөр ~2010он 9 сар30өдөр

(3) Утааны хэмжилтийн зориулалттай фланц суурилуулалт

Гүйцэтгэгч нь захиалагчийн товлосон УХЗ-ны яндан эсвэл утаан замд захиалагчийн тэмдэглэсэн газарт захиалагчийн бэлтгэсэн утааны хэмжилтийн зориулалттай фланжийг төмөр янданд гагнаж, тоосго болон бетон байх үед халуун тэсвэртэй зуурмаг ашиглан суурилуулна.

Суурилуулалтын аргачлалын дэлгэрэнгүйг хавсралтанд үзүүлэв.

Суурилуулалтанд анхаарах зүйл

① Гүйцэтгэлийн газар нь дээвэр дээр байрлах үе байх учраас 4м-тэй шат бэлтгэх

② Фланц суурилуулах газар нь 3-м-ээс дээр байрлах тул өндөр газарт ажиллах зориулалт бүхий тавцан бэлгэх

③ Янданг нүхэлснээс болоод яндан нь нурчихгүй байх тал дээр анхаарч, нурчих магадлалтай болсон үед ажлаа зогсоож захиалагч болон НАЧА-нд мэдэгдэж зааварчилгаа авах

④ Суурилуулсны дараа баримтжуулсан зургийг ойроос болон холоос авах

(4) Хийх төлөвлөгөөний шийдэл

Гүйцэтгэгч нь доорхи зүйлсийг хамруулсан гүйцэтгэлийн төлөвлөгөөг гаргаж захиалагчид хүргүүлнэ

- Гүйцэтгэлийн явцын хүснэгт
- Бүтээмжийн зохион байгуулалтын хүснэгт (Ажлын хэсгийн бүдүүвч • агуулга болон хариуцагч)
- Бусад хэрэгтэй гэсэн зүйл

(5) Зуух эзэмшигч болон тухайн газар руу нэвтрэх зөвшөөрөл

Гүйцэтгэгч нь утааны хэмжилтийн зориулалттай фланцийг суурилуулахад шаардлагатай холбогдох албан тушаалтны зөвшөөрлийг урьдчилан НАЧА-аас гаргуулж авна. Мөн утааны хэмжилтийн зориулалттай фланц суурилуулахад албаны, нийтийн, хувийн эзэмшил газарт нэвтрэх үед гүйцэтгэгч нь холбогдох хүмүүстэй таарамжтай харьцааг хадгалан, төвөг учруулалгүй ажлаа гүйцэтгэнэ.

(6) Фланц суурилуулах ажиллагаа

- Гүйцэтгэгч нь захиалагчийн сонгосон УХЗ-ны янданд захиалагчаас өгөх фланцийг захиалагчийн тэмдэглэсэн газарт өгөгдлийн дагуу нүх гаргаж төмөр янданд цахилгаан гагнуураар гагнаж, тоосго болон бетон янданд халуун тэсвэртэй зуурмагаар бөхөлж өгнө.
- Суурилуулах газар 20 байна
- Гүйцэтгэгч нь утааны хэмжилтийн зориулалттай фланц суурилуулхаас өмнөх болон дараах байдлын зураг авч захиалагч ид бичгээр болон файлаар (CD зэрэг) гүйцэтгэлийн бодит байдлыг тайлагнана.
- Гүйцэтгэгчийн фланц суурилуулалтын ажилд НАЧА-аас хамт явна.

(7) Ажиллагааны хяналт

- Гүйцэтгэгч нь тогтмол захиалагчтай холбоотойгоор ажилаа явуулж тодорхой үе шат бүртээ захиалагчид мэдээлэн түүний дараа ажлын заавар авч ажиллана. Мөн судалгаанд нэн шаардлагатай гэж үзсэн тохиолдолд захиалагч талтай хэлэлцэж урьдчилан зөвшөөрөл авна.
- Гүйцэтгэгч нь фланц суурилуулалтын гүйцэтгэх ажлын явцдаа аваар осолгүй байх тал дээр хичээж ажиллана. Осол гарсан тохиолдолд тэр тухайгаа захиалагчид мэдээлэх ба гарсан хохирлыг гүйцэтгэгч тал бүрэн хариуцна.

(8) Зардлын зохицуулалт

Утааны хэмжилтийн зориулалттай фланц суурилуулахад шаардлагатай хүн хүч, унаа, материал, бусад үрэгдэх материалын зардлыг гүйцэтгэгч тал бүрэн хариуцна.

2.2 Эргэлзээ

Гүйцэтгэгч нь ажил гүйцэтгэлийн явцад эргэлзээ үүссэн тохиолдолд захиалагчтай зөвшилцсний үндсэн дээр гүйцэтгэнэ.

2.3 Бэлэн болсон бүтээгдхүүн

- Гүйцэтгэгч нь хувиарын дагуу бүтээгдхүүнийг хүргүүлж өгч захиалагчаар шалгуулан зөвшөөрүүлсэн байх
- Захиалагч нь гүйцэтгэсэн ажлаа хүлээлгэх үедээ захиалагч талыг оролцуулах

Appendix 2.2-4 Emission Measurement Result

[H-R-1] HOB measurement result

Measurement Date		24-Nov-10	25-Nov-10	30-Nov-10	2-Dec-10	14-Dec-10			23-Dec-10		24-Jan-11			
General information	Place	Childcare	Train Repair	NO.39school	Bosa	Train Repair			Childcare		NO.310 Army			
	Type of boiler	MUHT	BZUI-100	DZL-1.4	RJG-18	BZUI-100			MUHT		HP-18-54			
	Capacity	MW	0.7	0.85	1.4	-			0.85		0.7		0.73	
	Cross sectional area of duct	m2	0.20	0.64	0.11	0.16			0.64		0.20		0.65	
	Type of coal		Nalaikh (crushed)	Shiveovoo	Nalaikh (crushed)	Nalaikh (crushed)	Shiveovoo (lump + crushed)			Nalaikh (crushed)		Nalaikh (crushed)		
Operational condition	Velocity of flue gas *1	m/s	-	-	15.6	7.2	13.6	12.7	15.6	10.2	8.9	3.9	4.4	2.5
	Temperature of flue gas *1	°C	-	-	66	198	145	190	234	110	103	134	148	131
	Water vapor concentration *1	%	-	-	30.0	12.1	5.5			2.8		1.7		
	Flow rate of wet flue gas	Nm3/h	-	-	4,200	2,100	17,900	15,100	16,900	2,800	2,600	5,300	5,800	3,500
	Flow rate of dry flue gas	Nm3/h	-	-	2,900	1,700	17,000	14,000	16,000	2,700	2,500	5,200	5,700	3,400
	Ave. flow rate of dry flue gas	Nm3/h	-	-	2,900	1,700	16,000			2,600		4,800		
	Coal feed rate	kg/h	-	-	228	138	672			394	266	223		
	O2 concentration *2	%	-	-	16.1	14.0	18			17.5		18.4		
	CO2 concentration *2	%	-	-	2.8	6.1	2.8			3.0		2.3		
	CO concentration *2	ppm	-	-	370	610	200			130		480		
Measured concentration (Raw data)	Dust concentration	g/Nm3	-	1.0	0.028	2.1	1.8	1.8	4.5	1.2	0.70	0.55	0.16	0.037
	Average dust concentration	g/Nm3	-	1.0	0.028	2.1	2.7			1.0		0.25		
	SO2 (ppm) *2	ppm	-	-	125	412	95			-		94		
	NOX (ppm) *2	ppm	-	-	49	78	32			-		35		

Emission Factor	Dust	kg/t	-	-	0.35	25	64			8.3	6.6	5.3		
	SO2	kg/t	-	-	4.5	14.5	6.5			-		5.8		
	NOX *3	kg/t	-	-	0.8	1.3	1.0			-		1.0		
	CO	kg/t			5.9	9.4	6.0			1.32		12.9		
Dust sampling method			-	Trial	Trial	Trial	Trial			Trial		20min×3		

*1 30min average value
 *2 Average values measured by TESTO
 *3 NO molecular weight is used for converting the NOx unit from ppm to mg/m3

Emission Concentration after O2 conversion at 9.33%	Dust	g/Nm3	-	-	0.065	3.4	9.8			3.2		1.1		
	SO2	ppm	-	-	298	687	346			-		421		
	NOX	ppm	-	-	117	130	117			-		156		
	CO				880	1000	730			430		2200		
Emission Standard Value (MNS)	Dust	g/Nm3	0.4	0.3	0.3	0.4	0.3			0.4		0.4		
	SO2	ppm	280	210	210	280	210			280		280		
	NOX	ppm	336	299	299	336	299			336		336		
	CO		2000	1600	1600	2000	1600			2000		2000		

*4 Data in 'Emission Concentraion' table above are currently provided for reference purpose only at May 2011, because only a few instantaneous measured values are gained by Testo, exhaust gas analyzer, to calculate the average data for one measurement task, and not averaged from long time measurement values.

Therefore, it is not recommendable to use the data in 'Emission Concentration' table for evaluating the pollution level of each emission source by comparing with 'Emission Standard' value.

[H-R-1] HOB measurement result

Measurement Date			26-Jan-11				28-Jan-11				31-Jan-11		1-Feb-11	
General information	Place		NO.310 Army				NO.310 Army				Bosa		Bosa	
	Type of boiler		HP-18-54				HP-18-54				RJG-18		RJG-18	
	Capacity	MW	0.73				0.73				-		-	
	Cross sectional area of duct	m2	0.65				0.65				0.16		0.16	
	Type of coal		Nalaikh (crushed)				Nalaikh (crushed)				Nalaikh (crushed)		Nalaikh (crushed)	
Operational condition	Velocity of flue gas *1	m/s	4.0	3.3	3.5	4.0	7.6	8.2	8.4	8.5	7.8	7.2	7.6	7.2
	Temperature of flue gas *1	°C	156	151	145	142	152	149	161	179	279	291	261	200
	Water vapor concentration *1	%	1.6				1.2				4.9		6.6	
	Flow rate of wet flue gas	Nm3/h	5,200	4,400	4,700	5,400	10,200	10,900	11,000	10,600	3,400	1,700	1,900	2,100
	Flow rate of dry flue gas	Nm3/h	5,200	4,300	4,700	5,300	10,000	11,000	11,000	11,000	3,300	1,600	1,800	2,000
	Ave. flow rate of dry flue gas	Nm3/h	4,900				11,000				3,300		1,800	
	Coal feed rate	kg/h	222				167				-		86	
	O2 concentration *2	%	18.9				17.9				15.5		14.6	
	CO2 concentration *2	%	1.9				2.8				4.8		5.6	
	CO concentration *2	ppm	530				600				1500		780	
Measured concentration (Raw data)	Dust concentration	g/Nm3	0.32	0.53	0.32	0.25	0.37	0.14	0.16	0.58	-	11	12	19
	Average dust concentration	g/Nm3	0.35				0.31				-		14	
	SO2 (ppm) *2	ppm	-				137				-		-	
	NOX (ppm) *2	ppm	-				51				-		-	

Emission Factor	Dust	kg/t	7.8				20				-		295	
	SO2	kg/t	-				25.8				-		-	
	NOX *3	kg/t	-				4.5				-		-	
	CO	kg/t	14.6				49				-		20.3	
Dust sampling method			20min×4				20min×4				-		3 batches	

*1 30min average value
 *2 Average values measured by TESTO
 *3 NO molecular weight is used for converting the NOx unit from ppm to mg/m3

Emission Concentration after O2 conversion at 9.33%	Dust	g/Nm3	2.0				1.2				-		26	
	SO2	ppm	-				509				-		-	
	NOX	ppm	-				190				-		-	
	CO		2900				2200				3200		1400	
Emission Standard Value (MNS)	Dust	g/Nm3	0.4				0.4				0.4		0.4	
	SO2	ppm	280				280				280		280	
	NOX	ppm	336				336				336		336	
	CO		2000				2000				2000		2000	

*4 Data in 'Emission Concentraion' table above are currently provided for reference purpose only at May 2011, because only a few instantaneous measured values are gained by Testo, exhaust gas analyzer, to calculate the average data for one measurement task, and not averaged from long time measurement values.
 Therefore, it is not recommendable to use the data in 'Emission Concentration' table for evaluating the pollution level of each emission source by comparing with 'Emission Standard' value.

[H-R-1] HOB measurement result

Measurement Date			10-Feb-11				11-Feb-11				16-Feb-11			
General information	Place		NO.113 secondary school				NO.113 secondary school				BOSA			
	Type of boiler		MDZ-0.25				MDZ-0.25				R/JG-18			
	Capacity	MW	0.25				0.25				-			
	Cross sectional area of duct	m2	0.085				0.085				0.16			
	Type of coal		Nalaikh (lump)				Nalaikh (lump)				Nalaikh (crushed)			
Operational condition	Velocity of flue gas *1	m/s	3.5	3.2	5.3	4.9	5.2	5.0	4.2	5.1	7.1	6.9	7.7	7.0
	Temperature of flue gas *1	°C	298	259	262	283	257	230	171	164	221	218	281	245
	Water vapor concentration *1	%	2.7				11.7				5.9			
	Flow rate of wet flue gas	Nm3/h	440	440	730	660	730	730	700	850	2,000	1,900	1,900	1,900
	Flow rate of dry flue gas	Nm3/h	440	440	700	630	630	630	600	760	1,800	1,800	1,800	1,800
	Ave. flow rate of dry flue gas	Nm3/h	550				660				1,800			
	Coal feed rate	kg/h	69				86				144			
	O2 concentration *2	%	15.5				17.9				13.1			
	CO2 concentration *2	%	4.6				2.7				6.0			
	CO concentration *2	ppm	430				150				1,800			
Measured concentration (Raw data)	Dust concentration	g/Nm3	0.79	1.1	0.86	0.26	0.18	0.12	0.10	0.32	12	8	18	14
	Average dust concentration	g/Nm3	0.8				0.18				13			
	SO2 (ppm) *2	ppm	753				408				108			
	NOX (ppm) *2	ppm	188				31				70			

Emission Factor	Dust	kg/t	6.0				1.4				162			
	SO2	kg/t	17.1				9.0				3.9			
	NOX *3	kg/t	2.0				0.3				1.2			
	CO	kg/t	4.3				1.44				28.1			
Dust sampling method			20min×4				20min×4				3 batches			

*1 30min average value
 *2 Average values measured by TESTO
 *3 NO molecular weight is used for converting the NOx unit from ppm to mg/m3

Emission Concentration after O2 conversion at 9.33%	Dust	g/Nm3	1.6				0.67				19			
	SO2	ppm	1586				1516				159			
	NOX	ppm	396				115				103			
	CO		910				557				2600			
Emission Standard Value (MNS)	Dust	g/Nm3	0.4				0.4				0.4			
	SO2	ppm	280				280				280			
	NOX	ppm	336				336				336			
	CO		2000				2000				2000			

*4 Data in 'Emission Concentraion' table above are currently provided for reference purpose only at May 2011, because only a few instantaneous measured values are gained by Testo, exhaust gas analyzer, to calculate the average data for one measurement task, and not averaged from long time measurement values.

Therefore, it is not recommendable to use the data in 'Emission Concentration' table for evaluating the pollution level of each emission source by comparing with 'Emission Standard' value.

[H-R-1] HOB measurement result

Measurement Date			23-Feb-11			24-Feb-11			1-Mar-11			2-Mar-11		
General information	Place		NO.41secondary school			NO.41 secondary school			No.46 school			No 39 school		
	Type of boiler		MUHT			MUHT			KCR-300			DZL 1,4-0,7/95/70A		
	Capacity	MW	0.7			0.7			-			1.4		
	Cross sectional area of duct	m2	0.064			0.064			0.028			0.13		
	Type of coal		Nalaikh (lump)			Nalaikh (lump)			Nalaikh (lump)			Nalaikh (crushed)		
Operational condition	Velocity of flue gas *1	m/s	17.5	12.4	14.7	14.7	14.9	10.0	12.4	10.6	6.4	5.7	6.4	
	Temperature of flue gas *1	°C	207	373	195	178	199	182	276	196	106	109	114	
	Water vapor concentration *1	%	4.2			3.8			5.7			2.5		
	Flow rate of wet flue gas	Nm3/h	2,000	1,000	1,700	1,800	1,700	540	540	540	1,800	1,600	1,800	
	Flow rate of dry flue gas	Nm3/h	1,900	1,000	1,600	1,700	1,600	510	510	510	1,800	1,600	1,700	
	Ave. flow rate of dry flue gas	Nm3/h	1,500			1,600			510			1,700		
	Coal feed rate	kg/h	281			231			74			104		
	O2 concentration *2	%	17.5			19.3			14.4			16.8		
	CO2 concentration *2	%	3.4			1.9			6			3.8		
	CO concentration *2	ppm	340			330			16,000			178		
Measured concentration	Dust concentration	g/Nm3	0.55	0.67	0.19	0.18	0.27	0.39	0.23	0.019	0.034	0.021	0.032	
	Average dust concentration	g/Nm3	0.6			0.21			0.22			0.029		
(Raw data)	SO2 (ppm) *2	ppm	94			31			93			52		
	NOX (ppm) *2	ppm	36			24			47			30		

Emission Factor	Dust	kg/t	3.2			1.48			1.49			0.48		
	SO2	kg/t	1.43			0.60			1.84			2.41		
	NOX *3	kg/t	0.25			0.225			0.44			0.65		
	CO	kg/t	2.27			2.86			138			3.6		
Dust sampling method			Many Batches			3 batches			1 batch					

*1 30min average value

*2 Average values measured by TESTO

*3 NO molecular weight is used for converting the NOx unit from ppm to mg/m3

Emission Concentration after O2 conversion at 9.33%	Dust	g/Nm3	2.0			1.5			0.38			0.082		
	SO2	ppm	312			214			165			144		
	NOX	ppm	119			166			83			83		
	CO		1100			2300			28000			500		
Emission Standard Value (MNS)	Dust	g/Nm3	0.4			0.4			0.4			0.3		
	SO2	ppm	280			280			280			210		
	NOX	ppm	336			336			336			299		
	CO		2000			2000			2000			1600		

*4 Data in 'Emission Concentraion' table above are currently provided for reference purpose only at May 2011, because only a few instantaneous measured values are gained by Testo, exhaust gas analyzer, to calculate the average data for one measurement task, and not averaged from long time measurement values.

Therefore, it is not recommendable to use the data in 'Emission Concentration' table for evaluating the pollution level of each emission source by comparing with 'Emission Standard' value.

[H-R-1] HOB measurement result

Measurement Date			3-Mar-11			8-Mar-11			9-Mar-11			11-Mar-11		
General information	Place		No.104 school			Burd center			No.106 school			No 10 secondary school		
	Type of boiler		WWGS 035			LSG-0.2			Thrmocholor-0.3			MWB-1		
	Capacity	MW	0.35			-			-			1.0		
	Cross sectional area of duct	m2	0.068			0.13			0.096			0.50		
	Type of coal		Nalaikh (crushed)			Nalaikh (lump)			Nalaikh (crushed)			Nalaikh (crushed)		
Operational condition	Velocity of flue gas *1	m/s	7.9	2.7	3.9	6.6	6.9	2.1	6.5	5.3	5.2	6.6	6.4	6.5
	Temperature of flue gas *1	℃	128	127	117	467	310	191	86	74	48	161	162	161
	Water vapor concentration *1	%	9.8			5.9			2.32			2.3		
	Flow rate of wet flue gas	Nm3/h	1,100	380	570	1,100	1,500	600	1,500	1,200	1,300	6,500	6,500	6,400
	Flow rate of dry flue gas	Nm3/h	1,000	350	510	1,100	1,400	570	1,500	1,200	1,300	6,300	6,400	6,300
	Ave. flow rate of dry flue gas	Nm3/h	620			1,000			1,300			6,300		
	Coal feed rate	kg/h	85			24			57			750		
	O2 concentration *2	%	12.0			10.3			14.5			16		
	CO2 concentration *2	%	7.8			10			5.7			4.3		
	CO concentration *2	ppm	26,170			1,250			13,670			580		
Measured concentration (Raw data)	Dust concentration	g/Nm3	0.078	0.024	0.14	0.11	0.030	0.41	3.3	1.7	2.0	2.5	3.6	2.2
	Average dust concentration	g/Nm3	0.082			0.18			2.3			2.7		
	SO2 (ppm) *2	ppm	41			240			19			183		
	NOX (ppm) *2	ppm	73			88			58			48		

Emission Factor	Dust	kg/t	0.59			7.6			53			23		
	SO2	kg/t	0.85			28.6			1.3			4.4		
	NOX *3	kg/t	0.71			4.9			1.8			0.54		
	CO	kg/t	239			65			390			6.1		
Dust sampling method			3 batches			3 batches			2 batches			3 batches		

*1 30min average value

*2 Average values measured by TESTO

*3 NO molecular weight is used for converting the NOx unit from ppm to mg/m3

Emission Concentration after O2 conversion at 9.33%	Dust	g/Nm3	0.11			0.20			4.2			6.2		
	SO2	ppm	53			261			35			410		
	NOX	ppm	95			96			103			107		
	CO		34000			1400			25000			1300		
Emission Standard Value (MNS)	Dust	g/Nm3	0.4			0.4			0.3			0.3		
	SO2	ppm	280			280			210			210		
	NOX	ppm	336			336			299			299		
	CO		2000			2000			1600			1600		

*4 Data in 'Emission Concentraion' table above are currently provided for reference purpose only at May 2011, because only a few instantaneous measured values are gained by Testo, exhaust gas analyzer, to calculate the average data for one measurement task, and not averaged from long time measurement values.

Therefore, it is not recommendable to use the data in 'Emission Concentration' table for evaluating the pollution level of each emission source by comparing with 'Emission Standard' value.

[H-R-1] HOB measurement result

Measurement Date		15-Mar-11			16-Mar-11			
General information	Place	No 71 school			No 92 secondagy school			
	Type of boiler	DLIRSH 170-80/55-AII*AIH			MDZ-800			
	Capacity	MW	0.17			0.8		
	Cross sectional area of duct	m2	0.085			0.064		
	Type of coal	Baganuur (lump)			Baganuur (lump + crushed)			
Operational condition	Velocity of flue gas *1	m/s	6.8	1.7	5.6	6.2	6.2	6.4
	Temperature of flue gas *1	℃	284	168	209	129	84	57
	Water vapor concentration *1	%	6.3			5.46		
	Flow rate of wet flue gas	Nm3/h	880	280	850	3,400	3,900	4,300
	Flow rate of dry flue gas	Nm3/h	820	250	790	3,300	3,700	4,100
	Ave. flow rate of dry flue gas	Nm3/h	620			3,700		
	Coal feed rate	kg/h	48			138		
	O2 concentration *2	%	11			12.9		
	CO2 concentration *2	%	9.0			7.1		
	CO concentration *2	ppm	400			1,040		
Measured concentration	Dust concentration	g/Nm3	0.28	0.071	0.69	1.1	0.10	0.30
	Average dust concentration	g/Nm3	0.35			0.49		
(Raw data)	SO2 (ppm) *2	ppm	47			89		
	NOX (ppm) *2	ppm	123			118		

Emission Factor	Dust	kg/t	4.5			13.2		
	SO2	kg/t	1.75			6.8		
	NOX *3	kg/t	2.13			4.2		
	CO	kg/t	6.5			35		
Dust sampling method			3 batches			2 batches		

*1 30min average value

*2 Average values measured by TESTO

*3 NO molecular weight is used for converting the NOx unit from ppm to mg/m3

Emission Concentration after O2 conversion at 9.33%	Dust	g/Nm3	0.40			0.7		
	SO2	ppm	54			128		
	NOX	ppm	141			170		
	CO		460			1500		
Emission Standard Value (MNS)	Dust	g/Nm3	0.4			0.4		
	SO2	ppm	280			280		
	NOX	ppm	336			336		
	CO		1600			2000		

*4 Data in 'Emission Concentraion' table above are currently provided for reference purpose only at May 2011, because only a few instantaneous measured values are gained by Testo, exhaust gas analyzer, to calculate the average data for one measurement task, and not averaged from long time measurement values.

Therefore, it is not recommendable to use the data in 'Emission Concentration' table for evaluating the pollution level of each emission source by comparing with 'Emission Standard' value.

[P-R-1] Measurement results of NO.2 Power Plant

Measurement Date			19-Jan				21-Jan				17-Feb				18-Feb			
No. of boiler			NO.5(75t/h)				NO.3(35t/h)				NO.4(75t/h)				NO.5(75t/h)			
Cross sectional area of duct		m2	1.50		1.61		1.81		1.81		1.40		1.40		1.50		1.61	
Type of coal			Buguuur		Buguuur		Buguuur		Buguuur		Buguuur		Buguuur		Buguuur		Buguuur	
Measurement duct			before scrubber		after scrubber		before scrubber		after scrubber		before scrubber		after scrubber		before scrubber		after scrubber	
			left duct	right duct	left duct	right duct	left duct	right duct	left duct	right duct	right duct	left duct	right duct	left duct	right duct	left duct	right duct	left duct
Operational condition	Velocity of flue gas	m/s	19.4	12.3	14.0	13.8	5.5	9.4	8.2	7.3	-	-	17.7	15.4	17.6	18.6	12.7	15.4
	Temperature of flue gas	°C	145	-	120	-	157	-	146	-	-	-	120	122	150	150	132	132
	Water vapor concentration	%	9.7	-	10.0	-	11.1	-	11.1	-	-	-	10.6	9.8	11.0	11.0	9.8	9.8
	Flow rate of wet flue gas	Nm3/h	59,000	38,000	49,000	48,000	19,900	34,000	29,300	26,900	-	-	53,000	46,000	52,000	55,000	43,000	52,000
	Flow rate of dry flue gas	Nm3/h	53,000	34,000	44,000	43,000	17,700	30,200	26,100	23,900	-	-	47,000	42,000	47,000	49,000	38,000	46,000
	Total flow rate of dry flue gas	Nm3/h	87,000		87,000		47,900		50,000		-		89,000		96,000		84,000	
	Coal feed rate	kg/h	17,110				10,580				17,830				20,630			
	O2 concentration	%	14.2	-	6.8	-	6.4	-	8.5	-	-	-	7.6	-	-	8.4	-	11.4
	CO2 concentration	%	6.0	-	12	-	12	-	11	-	-	-	12	-	-	11	-	8.4
	CO concentration	ppm	58	-	6,200	-	29,000	-	7,000	-	-	-	200	-	-	3,500	-	1,300
Dust (Raw data)	Dust concentration	g/m3N	1.4	9	1.1	1.1	18	11	7.1	2.6	-	-	1.6	1.5	11	11	1.7	1.7
	Average of Dust concentration	g/m3N	5.3		1.1		15		4.8		-		1.5		11		1.7	
	Efficiency of de-dust	%	78.4%				67.1%				-				84.2%			
Gas (Raw data)	NOX concentration	ppm	88	-	-	-	103	-	109	-	-	-	141	148	-	116	-	117
	SO2 concentration	ppm	94	-	-	-	251	-	245	-	-	-	88	88	-	133	-	117
	Measurement time	-	14:55	-	11:50	-	14:50	-	11:49	-	-	-	11:50	12:08	-	11:00	-	10:10

Emission Factor	Dust factor for each duct	kg/t	-	2.9	2.8	-	18	5.8	-	4.2	3.4	25	25	3.2	3.8			
	Dust factor as a boiler	kg/t	-	5.8		-	23		-	7.6		-	7.0					
	SO2	kg/t	-	-		-	3.3		-	1.26		-	1.5					
	NOX	kg/t	-	-		-	0.69		-	0.97		-	0.64					
	CO	kg/t	-	39		-	41		-	1.25		-	6.6					
Emission Concentration after O2 conversion at 6%	Dust	g/Nm3	1.2				5.8				1.7				2.7			
	SO2	ppm	-				294				98				182			
	NOX	ppm	-				131				162				182			
	CO	ppm	6500				8400				220				2000			
Emission Standard Value (MNS)	Dust	g/Nm3	21				10.6				21				21			
	SO2	ppm	676.1				619.5				676.1				676.1			
	NOX	ppm	948.3				530.1				948.3				948.3			
	CO	ppm	2838				70				2838				2838			
Remarks																		

* Data in 'Emission Concentraion' table above are currently provided for reference purpose only at May 2011, because only a few instantaneous measured values are gained by Testo, exhaust gas analyzer, to calculate the average data for one measurement task, and not averaged from long time measurement values. Therefore, it is not recommendable to use the data in 'Emission Concentration' table for evaluating the pollution level of each emission source by comparing with 'Emission Standard' value.

[P-R-1] Measurement results of NO.3 Power Plant

Measurement Date			7-Dec				9-Dec				16-Dec				17-Dec				
No. of boiler			NO.10(220t/h)				NO.7(220t/h)				NO.6(75t/h)				NO.4(75t/h)				
Cross sectional area of duct		m2	5.07		3.72		5.07		3.72		2.36		1.88		2.12		1.44		
Type of coal			Buganuur		Buganuur		Buganuur		Buganuur		Buganuur		Buganuur		Buganuur		Buganuur		
Measurement duct			before scrubber		after scrubber		before scrubber		after scrubber		before scrubber		after scrubber		before scrubber		after scrubber		
			left duct	right duct	left duct	right duct	left duct	right duct	left duct	right duct	left duct	right duct	left duct	right duct	left duct	right duct	left duct	right duct	
Operational condition	Velocity of flue gas	m/s	12.1	11.2	12.0	10.6	13.8	11.5	7.2	9.6	10.3	8.2	11.3	11.1	10.8	11.6	16.1	23.6	
	Temperature of flue gas	℃	172	-	73	-	215	-	98	-	-	-	116	84	-	127	-	83	-
	Water vapor concentration	%	7.3	-	39.7	-	10.6	-	5.7	5.1	14.4	15.5	14.0	-	11.5	9.4	14.7	12.4	
	Flow rate of wet flue gas	Nm3/h	116,000	107,000	108,000	95,000	120,000	100,000	60,000	80,000	53,000	42,000	50,000	49,000	48,000	52,000	54,000	79,000	
	Flow rate of dry flue gas	Nm3/h	110,000	100,000	65,000	58,000	107,000	89,000	57,000	76,000	45,000	35,000	43,000	42,000	43,000	47,000	46,000	69,000	
	Total flow rate of dry flue gas	Nm3/h	210,000		123,000		196,000		133,000		80,000		85,000		90,000		115,000		
	Coal feed rate	kg/h	26,820				33,021				13,528				12,714				
	O2 concentration	%	9.5	-	-	-	3.7	4.2	-	-	-	2.4	4.3	-	9.7	-	4.2	-	
	CO2 concentration	%	10	-	-	-	15	15	-	-	-	16	15	-	10	-	15	-	
	CO concentration	ppm	0	-	-	-	0	-	-	-	-	16,000	1,400	-	110	-	11,000	-	
Dust (Raw data)	Dust concentration	g/Nm3	5.5	5.1	0.22	0.53	11.2	11.9	0.79	0.73	8.5	11.2	0.65	0.34	19.5	18.1	0.57	1.2	
	Average of Dust concentration	g/Nm3	5.3		0.38		11.6		0.76		9.8		0.49		18.8		0.89		
	Efficiency of de-dust	%	92.9				93.4				95.0				95.3				
Gas (Raw data)	NOX concentration	ppm	210	-	-	-	494	-	-	-	-	-	-	-	189	-	164	-	
	SO2 concentration	ppm	329	-	-	-	465	-	-	-	-	-	-	-	199	-	236	-	
	Measurement time		11:43	-	14:38	-	11:00	11:20	15:10	-	-	-	13:37	10:50	-	13:40	-	10:45	-

Emission Factor	Dust factor for each duct	kg/t	-	0.53	1.2	-	1.36	1.68	-	2.07	1.05	-	2.1	6.5				
	Dust factor as a boiler	kg/t	-	1.7		-	3.0		-	3.1		-	8.6					
	SO2	kg/t	-	-	-	-	-	-	-	-	-	-	-	6.1				
	NOX	kg/t	-	-	-	-	-	-	-	-	-	-	-	1.99				
	CO	kg/t	-	-	-	-	-	-	-	11.0		-	-	124				
Emission Concentration after O2 conversion at 6%	Dust	g/Nm3	0.49				0.67				0.42				0.95			
	SO2	ppm	-				-				-				252			
	NOX	ppm	-				-				-				175			
	CO	ppm	-				-				1300				12000			
Emission Standard Value (MNS)	Dust	g/Nm3	10.8				10.8				21				1.2			
	SO2	ppm	519.8				519.8				676.1				215.3			
	NOX	ppm	821.3				821.3				948.3				238.9			
	CO	ppm	240				240				2838				4996			
Remarks			Fluidized bed furnace															

* Molecular weight of NO is used for converting the NOx unit from ppm to mg/m3

* Data in 'Emission Concentraion' table above are currently provided for reference purpose only at May 2011, because only a few instantaneous measured values are gained by Testo, exhaust gas analyzer, to calculate the average data for one measurement task, and not averaged from long time measurement values. Therefore, it is not recommendable to use the data in 'Emission Concentration' table for evaluating the pollution level of each emission source by comparing with 'Emission Standard' value.

[P-R-1] Measurement results of NO.4 Power Plant

Measurement Date			1-Sep-10					2-Sep-10					7-Sep-10				
No. of boiler			NO.1					NO.2					NO.4				
Cross sectional area of duct		m2	3.50	3.50	3.50	3.50	11.99	3.50	3.50	3.50	3.50	11.99	3.50	3.50	3.50	3.50	11.99
Type of coal			Baganuur					Baganuur					Baganuur				
Measurement duct			before EP				after EP	before EP				after EP	before EP				after EP
			left1 duct	left2 duct	right2 duct	right1 duct	duct	left1 duct	left2 duct	right2 duct	right1 duct	duct	left1 duct	left2 duct	right2 duct	right1 duct	duct
Operational condition	Velocity of flue gas	m/s	13.8	17.4	18.6	14.2	18.0	19.5	18.8	17.2	16.5	18.8	16.2	19.2	18.2	15.8	19.1
	Temperature of flue gas	°C	151	174	161	135	151	151	165	156	154	149	151	168	165	133	140
	Water vapor concentration	%	11.2	12.4	10.2	5.5	9.8	8.1	9.5	9.1	10.4	9.3	10.6	10.6	10.6	10.6	10.6
	Flow rate of wet flue gas	Nm3/h	100,000	130,000	110,000	100,000	420,000	110,000	120,000	130,000	140,000	440,000	110,000	120,000	130,000	110,000	470,000
	Flow rate of dry flue gas	Nm3/h	96,000	110,000	100,000	85,000	380,000	100,000	110,000	110,000	120,000	400,000	100,000	110,000	120,000	100,000	420,000
	Coal feed rate	kg/h	62,560					74,000					73,500				
	O2 concentration	%	4.6	3.7	5.7	8.6	6.6	3.6	5.2	4.9	5.9	5.7	5.3	4.2	3.6	6.6	5.9
	CO2 concentration	%	14	15	13	11	13	15	14	14	13	13	14	15	15	13	13
	CO concentration	ppm	4	4.8	4	4.8	3	8	3	2	2	4	4	2	2	4	3
Dust (Raw data)	Dust concentration	g/Nm3	10	13	0.57	0.41	0.30	3.8	3.3	3.7	3.1	0.0028	5.8	5.2	3.9	5.9	0.036
	Average of Dust concentration	g/Nm3	6.0				0.30	3.4				0.0028	5.2				0.036
	Efficiency of de-dust	%	95.0					99.9					99.3				
Gas (Raw data)	NOX concentration	ppm	386	359	367	429	383	-	-	-	-	-	390	385	374	350	385
	SO2 concentration	ppm	31	58	7	3	58	-	-	-	-	-	190	182	155	49	134
	Measurement time		-	-	-	-	-	-	-	-	-	-	-	-	-	-	-

Emission Factor	Dust	kg/t	-					1.8	-					0.02	-					0.2
	SO2	kg/t	-					1.0	-					-	-					2.2
	NOX	kg/t	-					3.1	-					-	-					2.9
	CO	kg/t	-					0.0	-					0.0	-					0.0
Emission Concentration after O2 conversion at 6%	Dust	g/Nm3	0.31					0.0027					0.036							
	SO2	ppm	60					-					133							
	NOX	ppm	398					-					382							
	CO	ppm	3					4					3							
Emission Standard Value (MNS)	Dust	g/Nm3	0.2					0.2					0.2							
	SO2	ppm	420					420					420							
	NOX	ppm	533.9					533.9					533.9							
	CO	ppm	144					144					144							

* Data in 'Emission Concentraion' table above are currently provided for reference purpose only at May 2011, because only a few instantaneous measured values are gained by Testo, exhaust gas analyzer, to calculate the average data for one measurement task, and not averaged from long time measurement values.

Therefore, it is not recommendable to use the data in 'Emission Concentration' table for evaluating the pollution level of each emission source by comparing with 'Emission Standard' value.

[P-R-1] Measurement results of NO.4 Power Plant

Measurement Date			8-Sep-10					14-Sep-10				
No. of boiler			NO.5					NO.3				
Cross sectional area of duct		m2	3.50	3.50	3.50	3.50	11.99	3.50	3.50	3.50	3.50	11.99
Type of coal			Shivee ovoo					Baganuur				
Measurement duct			before EP				after EP	before EP				after EP
			left1 duct	left2 duct	right2 duct	right1 duct	duct	left1 duct	left2 duct	right2 duct	right1 duct	duct
Operational condition	Velocity of flue gas	m/s	13.2	20.6	18.8	12.3	19.1	19.5	22.2	21.8	20.2	23.3
	Temperature of flue gas	°C	144	175	164	137	154	142	164	158	147	141
	Water vapor concentration	%	19.7	2.6	0.08	9.3	7.9	5.4	8.4	9.0	4.9	6.9
	Flow rate of wet flue gas	Nm3/h	90,000	120,000	130,000	90,000	440,000	140,000	150,000	150,000	140,000	570,000
	Flow rate of dry flue gas	Nm3/h	80,000	120,000	130,000	70,000	410,000	130,000	140,000	140,000	130,000	530,000
	Coal feed rate	kg/h	84,000					69,100				
	O2 concentration	%	6.1	4.2	4.5	6.4	5.9	6.5	5.2	6.2	7.4	6.7
	CO2 concentration	%	13	15	14	13	13	13	14	13	12	13
	CO concentration	ppm	2	1	1	2	2	4	2	2	5	3
Dust (Raw data)	Dust concentration	g/Nm3	7.7	3.9	9.1	7.0	0.093	11	9.3	10	9.5	0.37
	Average of Dust concentration	g/Nm3	6.9				0.093	9.8				0.37
	Efficiency of de-dust	%	98.7					96.2				
Gas (Raw data)	NOX concentration	ppm	522	475	473	473	457	380	309	380	363	376
	SO2 concentration	ppm	643	704	576	671	90	2	109	67	16	0
	Measurement time		-	-	-	-	-	-	-	-	-	-

Emission Factor	Dust	kg/t	-				0.5	-				2.9
	SO2	kg/t	-				1.3	-				0.0
	NOX	kg/t	-				3.0	-				3.9
	CO	kg/t	-				0.0	-				0.0
Emission Concentration after O2 conversion at 6%	Dust	g/Nm3	0.093					0.39				
	SO2	ppm	90					0.0				
	NOX	ppm	456					393				
	CO	ppm	2					3				
Emission Standard Value (MNS)	Dust	g/Nm3	0.2					0.2				
	SO2	ppm	420					420				
	NOX	ppm	533.9					533.9				
	CO	ppm	144					144				

* Data in 'Emission Concentraion' table above are currently provided for reference purpose only at May 2011, because only a few instantaneous measured values are gained by Testo, exhaust gas analyzer, to calculate the average data for one measurement task, and not averaged from long time measurement values.

Therefore, it is not recommendable to use the data in 'Emission Concentration' table for evaluating the pollution level of each emission source by comparing with 'Emission Standard' value.

[H-R-1] HOB measurement result

Measurement Date		2011-1				2011-2				2011-3				2011-4				2011-5				
Measurement Date		16-Nov-11				25-Nov-11				29-Nov-11				2-Dec-11				9-Dec-11				
General information	Place	NO.41 school				Ikhzasag university-1				NO.114 school				Haan Bank				Tavan gan				
	Type of boiler	MUHT				DZL-0.7				WWGS-0.35				CLHG-0.6/C				CLSG25				
	Capacity	MW	0.7				0.70				0.35				0.60				0.25			
	Cross sectional area of duct	m2	0.062				0.075				0.085				0.062				0.049			
	Type of coal	Nalaikh				Nalaikh				Nalaikh				Nalaikh				Nalaikh				
Operational condition	Velocity of flue gas	m/s	-	-	-	-	6.4	5.8	7.3	-	7.7	7.4	7.2	-	3.0	2.9	3.6	-	11.6	13.8	11.5	-
	Temperature of flue gas	°C	-	-	-	-	87	84	83	-	101	94	80	-	219	173	234	-	341	502	360	-
	Water vapor concentration	%					4.3				1.1				2.2				7.7			
	Flow rate of wet flue gas	Nm3/h					1124	1015	1286	-	1528	1497	1507	-	318	331	362	-	795	752	760	-
	Flow rate of wet flue gas	Nm3/h					1100	1000	1300	-	1500	1500	1500	-	320	330	360	-	800	750	760	-
	Flow rate of dry flue gas	Nm3/h					1076	972	1231	-	1511	1480	1490	-	311	324	354	-	734	694	701	-
	Flow rate of dry flue gas	Nm3/h					1100	1000	1200	-	1500	1500	1500	-	310	320	350	-	730	690	700	-
	Ave. flow rate of dry flue gas	Nm3/h					1100				1500				320				710			
	Coal feed rate	kg/h	92				96				70				7.0				121			
	O2 concentration	%	15.7				16.5				18.3				12.4				15.9			
	CO2 concentration	%	4.3				4.4				2.3				7.2				3.7			
	CO concentration	ppm	2925				310				890				4790				1740			
Measured concentration	Dust concentration	g/Nm3	-	-	-	-	0.18	0.12	0.27	-	0.16	0.05	0.11	-	0.042	0.29	0.20	-	3.4	4.3	8.2	-
	Average dust concentration	g/Nm3	#DIV/0!				0.19				0.10				0.18				5.3			
(Raw data)	SO2 (ppm)	ppm	152				146				72				123				184			
	NOx (ppm)	ppm	34				44				34				78				39			

Emission Factor	Dust	kg/t	-				2.2				2.2				8.0				31			
	SO2	kg/t	-				4.8				4.4				16				3.1			
	NOx *	kg/t	-				0.67				1.0				4.8				0.31			
	CO	kg/t	-				4.4				24				275				13			
Dust sampling method																						

* NO molecular weight is used for converting the NOx unit from ppm to mg/m3

Emission Concentration after O2 conversion at 9.33%	Dust	g/Nm3					<u>0.60</u>				<u>0.46</u>				0.24				<u>12</u>			
	SO2	ppm	227				<u>372</u>				<u>300</u>				158				<u>382</u>			
	NOx	ppm	52				114				134				104				74			
	CO	ppm	<u>822</u>				793				<u>4754</u>				<u>6027</u>				<u>2224</u>			
Emission Standard Value (MNS)	Dust	g/Nm3	0.4				0.4				0.4				0.4				0.4			
	SO2	ppm	280				280				280				280				280			
	NOx	ppm	336				336				336				336				336			
	CO	ppm	2,000				2,000				2,000				2,000				2,000			

[H-R-1] HOB measurement result

Measurement Date		2011-6			2011-7			2011-8			2011-9			2011-10			
Measurement Date		14-Dec-11			16-Dec-11			20-Dec-11			22-Dec-11			4-Jan-12			
General information	Place	MCS Tiger beer			Ikhzasag university-3			NO.60 secondary school			kyoyulaakhuu			NO.113 secondary school			
	Type of boiler	DZL4			Unknown			MUHT			HP-18-54			MDZ-0.25			
	Capacity	MW	4.0			Unknown			0.70			0.40			0.25		
	Cross sectional area of duct	m2	0.12			0.20			0.075			0.79			0.091		
	Type of coal	Nalaikh			Nalaikh			Nalaikh			Nalaikh+excrement			Nalaikh			
Operational condition	Velocity of flue gas	m/s	29.4	29.2	31.3	10.6	9.9	26.7	24.1	1.8	1.1	1.4	3.1	5.5	3.3		
	Temperature of flue gas	°C	134	149	131	67	83	145	178	135	130	142	167	163	185		
	Water vapor concentration	%	4.9			3.3			5.3			0.56			4.3		
	Flow rate of wet flue gas	Nm3/h	8354	7999	8972	5337	4790	4019	3366	2996	1870	2229	537	973	561		
	Flow rate of wet flue gas	Nm3/h	8400	8000	9000	5300	4800	4000	3400	3000	1900	2200	540	970	560		
	Flow rate of dry flue gas	Nm3/h	7946	7609	8534	5161	4632	3804	3186	2979	1860	2217	501	937	547		
	Flow rate of dry flue gas	Nm3/h	7900	7600	8500	5200	4600	3800	3200	3000	1900	2200	500	940	550		
	Ave. flow rate of dry flue gas	Nm3/h	8000			4800			3500			2300			580		
	Coal feed rate	kg/h	2026			155			131			298			50		
	O2 concentration	%	16.4			17.6			16.7			17.2			13.4		
	CO2 concentration	%	3.9			3.1			3.7			3.4			6.5		
	CO concentration	ppm	630			890			920			812			1487		
Measured concentration	Dust concentration	g/Nm3	0.16	0.23	0.11	0.12	0.044	0.62	1.1	0.76	0.38	0.57	0.12	0.14	0.060		
	Average dust concentration	g/Nm3	0.16			0.075			0.82			0.60			0.11		
(Raw data)	SO2 (ppm)	ppm	112			134			116			97			245		
	NOx (ppm)	ppm	45			40			52			46			56		

21.90839695

Emission Factor	Dust	kg/t	0.65			2.3			22			4.6			1.3		
	SO2	kg/t	1.3			12			8.9			2.1			8.1		
	NOx *	kg/t	0.24			1.6			1.9			0.48			0.86		
	CO	kg/t	3.1			35			31			7.8			22		
Dust sampling method																	

* NO molecular weight is used for converting the NOx unit from ppm to mg/m3

Emission Concentration after O2 conversion at 9.33%	Dust	g/Nm3	0.53			0.26			2.2			1.6			0.18		
	SO2	ppm	345			466			318			281			392		
	NOx	ppm	138			131			129			141			88		
	CO	ppm	2145			3640			3683			3682			3716		
Emission Standard Value (MNS)	Dust	g/Nm3	12.0			0.3			0.4			0.4			0.4		
	SO2	ppm	567			210			280			280			280		
	NOx	ppm	859			299			336			336			336		
	CO	ppm	824			1600			2000			2000			2000		

[H-R-1] HOB measurement result

Measurement Date		2011-11				2011-12				2011-13				2011-14				2011-15				
5-Jan-12		6-Jan-12				10-Jan-12				11-Jan-12				12-Jan-12								
General information	Place	NO.92 school				Train Repair				NO.106 School				No.88 school				No.46school				
	Type of boiler	MDZ-063				BZUI 100				Thermochlor-0.3				KBPO7KB				CLSG				
	Capacity	MW	0.63				0.85				0.35				0.70				0.60			
	Cross sectional area of duct	m2	0.23				0.636				0.085				0.49				0.028			
	Type of coal	Nalaikh				Siveoovo				Nalaikh				Nalaikh				Nalaikh				
Operational condition	Velocity of flue gas	m/s	8.9	8.7	7.3		13.7	14.5	14.7		8.3	6.2	6.2		3.8	3.4	2.7		12.5	10.2		
	Temperature of flue gas	°C	101	97	107		225	243	217		77	117	96		90	93	92		244	167		
	Water vapor concentration	%	5.7				3.5				2.4				2.8				4.3			
	Flow rate of wet flue gas	Nm3/h	4750	4677	3850		17037	17391	18574		1737	1044	1216		4261	3786	3023		585	560		
	Flow rate of wet flue gas	Nm3/h	4800	4700	3900		17000	17000	19000		1700	1000	1200		4300	3800	3000		590	560		
	Flow rate of dry flue gas	Nm3/h	4477	4409	3629		16441	16782	17924		1696	1019	1187		4143	3682	2940		560	536		
	Flow rate of dry flue gas	Nm3/h	4500	4400	3600		16000	17000	18000		1700	1000	1200		4100	3700	2900		560	540		
	Ave. flow rate of dry flue gas	Nm3/h	4200				17200				1200				3600				570			
	Coal feed rate	kg/h	150				1334				126				125				46			
	O2 concentration	%	17.3				16.3				17.9				18.5				15.3			
	CO2 concentration	%	3.1				4.1				2.6				2.0				4.6			
	CO concentration	ppm	490				1990				650				729				3760			
Measured concentration	Dust concentration	g/Nm3	0.52	0.72	0.64		0.75	0.92	0.81		0.17	0.79	0.82		0.89	1.4	1.1		0.13	0.27		
	Average dust concentration	g/Nm3	0.63				0.83				0.62				1.1				0.20			
(Raw data)	SO2 (ppm)	ppm	58				102				87				76				182			
	NOx (ppm)	ppm	26				62				33				17				36			

Emission Factor	Dust	kg/t	18				11				5.9				32				2.5			
	SO2	kg/t	4.6				3.8				2.4				6.3				6.4			
	NOx *	kg/t	1.0				1.1				0.43				0.68				0.59			
	CO	kg/t	17				32				7.7				26				58			
Dust sampling method																						

* NO molecular weight is used for converting the NOx unit from ppm to mg/m3

Emission Concentration after O2 conversion at 9.33%	Dust	g/Nm3	<u>2.0</u>				<u>2.0</u>				<u>2.0</u>				<u>6.2</u>				<u>0.41</u>			
	SO2	ppm	182				266				322				369				361			
	NOx	ppm	82				151				128				80				72			
	CO	ppm	1896				2172				4642				3066				6649			
Emission Standard Value (MNS)	Dust	g/Nm3	0.4				0.3				0.4				0.4				0.4			
	SO2	ppm	280				210				280				280				280			
	NOx	ppm	336				299				336				336				336			
	CO	ppm	2000				1600				2000				2000				2000			

[H-R-1] HOB measurement result

Measurement Date		2011-16				2011-17				2011-18				2011-19				2011-19				
Measurement Date		15-Jan-12				17-Jan-12				19-Jan-12				20-Jan-12				22-Jan-12				
General information	Place	No.10 school				BELON LLC				No.17 Secondary School				No.58 Secondary School				No.59 School				
	Type of boiler	MWB-1				HP18-27				Viaduras VSB IV				MUHT 1.2				Mon dulaan				
	Capacity	1.0				0.2				0.385				0.70				0.063				
	Cross sectional area of duct	0.50				0.042				0.13				0.196				0.013				
	Type of coal	Nalaikh (crushed)				Nalaikh				Baganuur				Nalaikh				Nalaikh (lump)				
Operational condition	Velocity of flue gas	m/s	6.0	6.1	6.4		10.9	11.5	11.2		3.8	3.4	4.0		6.4	4.8	4.7		5.4	6.5		
	Temperature of flue gas	°C	168	168	171		298	316	299		127	80	122		135	101	108		235	232		
	Water vapor concentration	%	7.2				9.0				2.9				0.49				4.7			
	Flow rate of wet flue gas	Nm3/h	5826	5956	6175		673	684	689		1026	1069	1128		2527	2152	2084		143	143		
	Flow rate of wet flue gas	Nm3/h	5800	6000	6200		670	680	690		1000	1100	1100		2500	2200	2100		140	140		
	Flow rate of dry flue gas	Nm3/h	5421	5518	5733		612	622	627		997	1038	1096		2515	2141	2074		136	136		
	Flow rate of dry flue gas	Nm3/h	5400	5500	5700		610	620	630		1000	1000	1100		2500	2100	2100		140	140		
	Ave. flow rate of dry flue gas	Nm3/h	5600				620				1000				2300				140			
	Coal feed rate	kg/h	714				109				41				266				4.1			
	O2 concentration	%	16.0				12.9				17.6				14.5				15.3			
	CO2 concentration	%	3.9				6.4				3.1				5.9				5.0			
CO concentration	ppm	10900				4190				6993				6413				1990				
Measured concentration	Dust concentration	g/Nm3	2.0	3.1	1.9		1.0	1.3	0.80		0.027	0.86	0.82		3.9				0.0094	0.15		
	Average dust concentration	g/Nm3	2.3				1.0				0.17				3.9				0.10			
(Raw data)	SO2 (ppm)	ppm	254				65				100				197				150			
	NOx (ppm)	ppm	38				47				30				45				65			

Emission Factor	Dust	kg/t	18				5.8				4.1				34				3.5			
	SO2	kg/t	5.7				1.1				6.9				4.9				15			
	NOx *	kg/t	0.40				0.36				1.0				0.52				3.0			
	CO	kg/t	107				30				212				69				86			
Dust sampling method																						

* NO molecular weight is used for converting the NOx unit from ppm to mg/m3

Emission Concentration after O2 conversion at 9.33%	Dust	g/Nm3	5.4				1.5				0.55				7.0				0.16			
	SO2	ppm	592				280				350				322				302			
	NOx	ppm	89				183				96				70				132			
	CO	ppm	2327				605				2325				1170				4121			
Emission Standard Value (MNS)	Dust	g/Nm3	0.3				0.4				0.4				0.4				0.4			
	SO2	ppm	210				280				280				280				280			
	NOx	ppm	299				336				336				336				336			
	CO	ppm	1600				2000				2000				2000				2000			

[H-R-1] HOB measurement result

Measurement Date		2011-20				2011-21				2011-22				2011-23				2011-24				
31-Jan-12		31-Jan-12				1-Feb-12				3-Feb-12				9-Feb-12				10-Feb-12				
General information	Place	Police Academy				No. 71 School				No. 104 School				Ecology Institute				No. 118 School				
	Type of boiler	DZL 2.8				Dliirsh 170-88/55				WWGS 0.35				unknown				Carborobot 300				
	Capacity	MW	2.8				0.17				0.35				unknown				0.30			
	Cross sectional area of duct	m ²	0.181				0.152				0.068				0.138				0.025			
	Type of coal	Nalaikh				Buganuur				Nalaikh				Nalaikh				Nalaikh				
Operational condition	Velocity of flue gas	m/s	12.9	12.5	13.5		6.8	7.2			6.6	7.0	6.13		6.8	6.6	6.7		11.7	12.2	11.4	
	Temperature of flue gas	°C	164	171	175		220	221			188	197	182		225	195	214		98	98	105	
	Water vapor concentration	%	10.4				5.6				5.6				2.6				7.3			
	Flow rate of wet flue gas	Nm ³ /h	4529	4312	4620		1758	1874			820	853	771		1595	1658	1619		680	711	651	
	Flow rate of wet flue gas	Nm ³ /h	4500	4300	4600		1800	1900			820	850	770		1600	1700	1600		680	710	650	
	Flow rate of dry flue gas	Nm ³ /h	4059	3864	4140		1659	1768			774	806	729		1554	1616	1578		630	659	603	
	Flow rate of dry flue gas	Nm ³ /h	4100	3900	4100		1700	1800			770	810	730		1600	1600	1600		630	660	600	
	Ave. flow rate of dry flue gas	Nm ³ /h	4,000				1,700				770				1,600				630			
	Coal feed rate	kg/h	628				81				63				74				92			
	O ₂ concentration	%	10.9				14.0				12.3				17.9				15.0			
	CO ₂ concentration	%	8.7				6.0				7.2				2.5				5.0			
CO concentration	ppm	84				1185				5921				2922				2776				
Measured concentration	Dust concentration	g/Nm ³	0.18	0.32	0.27		0.36	0.59			0.17	0.19	0.028		0.67	0.073	0.066		0.58	0.64	0.35	
	Average dust concentration	g/Nm ³	0.26				0.48				0.13				0.27				0.53			
(Raw data)	SO ₂ (ppm)	ppm	442				124				221				110				237			
	NO _x (ppm)	ppm	126				84				40				23				68			

Emission Factor	Dust	kg/t	1.6				10				1.6				5.8				3.6			
	SO ₂	kg/t	8.0				7.4				7.8				6.8				4.7			
	NO _x *	kg/t	1.1				2.4				0.66				0.66				0.63			
	CO	kg/t	0.67				31				91				79				24			
Dust sampling method																						

* NO molecular weight is used for converting the NO_x unit from ppm to mg/m³

Emission Concentration after O ₂ conversion at 9.33%	Dust	g/Nm ³	0.30				<i>0.79</i>				0.18				<i>0.99</i>				<i>1.0</i>			
	SO ₂	ppm	<i>610</i>				206				<i>289</i>				<i>398</i>				<i>462</i>			
	NO _x	ppm	144				139				54				82				132			
	CO	ppm	97				<i>2118</i>				<i>6111</i>				<i>7418</i>				<i>6920</i>			
Emission Standard Value (MNS)	Dust	g/Nm ³	0.3				0.4				0.4				0.3				0.4			
	SO ₂	ppm	210				280				280				210				280			
	NO _x	ppm	299				336				336				299				336			
	CO	ppm	1600				2000				2000				1600				2000			

[H-R-1] HOB measurement result

Measurement Date		2011-25				2011-26				2011-27				
13-Feb-12		13-Feb-12				14-Feb-12				15-Feb-12				
General information	Place	No. 102 School				No. 63 School				No. 105 School				
	Type of boiler	HP18-27				BNEB				Viadurus				
	Capacity	MW	unknown				0.23				0.39			
	Cross sectional area of duct	m2	0.053				0.031				0.042			
	Type of coal	Nalaikh				Nalaikh				Baganuur				
Operational condition	Velocity of flue gas	m/s	11.6	11.7	10.3		3.7	3.7	4.0		13.7	12.8	11.7	
	Temperature of flue gas	°C	212	288	193		78	85	95		273	269	268	
	Water vapor concentration	%	7.0				3.5				7.8			
	Flow rate of wet flue gas	Nm3/h	1066	934	986		278	274	286		868	818	751	
	Flow rate of wet flue gas	Nm3/h	1100	930	990		280	270	290		870	820	750	
	Flow rate of dry flue gas	Nm3/h	991	869	917		268	265	276		801	754	693	
	Flow rate of dry flue gas	Nm3/h	990	870	920		270	260	280		800	750	690	
	Ave. flow rate of dry flue gas	Nm3/h	918				271				749			
	Coal feed rate	kg/h	60				17				112			
	O2 concentration	%	13.7				13.8				15.2			
	CO2 concentration	%	6.2				6.3				4.8			
	CO concentration	ppm	2183				743				973			
Measured concentration	Dust concentration	g/Nm3	1.35	1.23	0.30		0.37	0.072	0.076		0.23	0.15	0.14	
	Average dust concentration	g/Nm3	1.0				0.15				0.18			
(Raw data)	SO2 (ppm)	ppm	371				314				132			
	NOx (ppm)	ppm	38				80				47			

Emission Factor	Dust	kg/t	15				2.3				1.2			
	SO2	kg/t	16				14				2.5			
	NOx *	kg/t	0.78				1.7				0.4			
	CO	kg/t	42				15				8.1			
Dust sampling method														

* NO molecular weight is used for converting the NOx unit from ppm to mg/m3

Emission Concentration after O2 conversion at 9.33%	Dust	g/Nm3	1.6				0.24				0.35			
	SO2	ppm	606				491				269			
	NOx	ppm	62				125				93			
	CO	ppm	3789				1798				1893			
Emission Standard Value (MNS)	Dust	g/Nm3	0.3				0.4				0.4			
	SO2	ppm	210				280				280			
	NOx	ppm	299				336				336			
	CO	ppm	1600				2000				2000			

[P-R-1] Measurement results of NO.3 Power Plant

Measurement Date			6-Dec-11				7-Dec-11				24-Jan-12				24-Jan-12			
No. of boiler			NO.4(75t/h)				NO.6(75t/h)				NO.7(220t/h)				NO.10(220t/h)			
Cross sectional area of duct		m2	2.12		1.44		2.36		1.88		-		3.72		-		3.72	
Type of coal			Baganuur		Baganuur		Baganuur		Baganuur		Baganuur		Baganuur		Baganuur		Baganuur	
Measurement duct			before scrubber		after scrubber		before scrubber		after scrubber		before scrubber		after scrubber		before scrubber		after scrubber	
			left duct	right duct	left duct	right duct	left duct	right duct	left duct	right duct	left duct	right duct	left duct	right duct	left duct	right duct	left duct	right duct
Operational condition	Velocity of flue gas	m/s	10.1	10.9	10.9	11.3	28.2	28.3	24.8	25.0	-	-	8.1	8.7	-	-	10.1	11.8
	Temperature of flue gas	℃	131	116	68	53	168	163	68	74	-	-	82	80	-	-	64	64
	Water vapor concentration	%	8.5	8.7	12.3	10.7	5.5	11.2	3.9	3.9	-	-	5.5	16.5	-	-	3.9	9.0
	Flow rate of wet flue gas	Nm3/h	44,500	50,200	38,300	41,500	128,400	130,500	115,100	114,200	-	-	70,800	75,500	-	-	90,400	106,500
	Flow rate of dry flue gas	Nm3/h	40,800	45,900	33,600	37,100	121,400	116,000	110,600	109,800	-	-	67,000	63,000	-	-	86,900	96,900
	Total flow rate of dry flue gas	Nm3/h	86,700		70,700		237,400		220,400		-		130,000		-		183,800	
	Coal feed rate	kg/h	11,000				14,000				37,340				26,820			
	O2 concentration	%	8.6	8.9	8.8	9.0	5.7	4.8	4.4	5.2	-	-	14.0	14.6	-	-	16.3	16.3
	CO2 concentration	%	11.1	10.8	10.9	10.7	13.4	14.3	14.8	13.9	-	-	6.4	5.8	-	-	4.4	4.4
CO concentration	ppm	177	130	152	129	21	31	33	26	-	-	77	27	-	-	2.4	2.4	
Dust (Raw data)	Dust concentration	g/Nm3	8.75	9.19	0.28	0.09	5.99	6.23	0.75	0.58	-	-	1.55	1.39	-	-	0.40	0.47
	Average of Dust concentration	g/Nm3	9.0		0.19		6.11		0.67		-		1.47		-		0.43	
	Efficiency of de-dust	%	97.9				89.1				-				-			
Gas (Raw data)	NOx concentration	ppm	209	216	213	215	311	307	350	306	-	-	146	142	-	-	95	95
	SO2 concentration	ppm	316	275	208	225	237	272	145	182	-	-	173	156	-	-	54	54
	Measurement time		14:33-15:19	15:24-15:46	13:02-13:39	13:46-14:32	13:38-13:54	13:02-13:23	11:32-12:07	12:12-12:48	-	-	12:10-13:51	15:02-16:10	-	-	16:50-17:30	18:24-19:47

Emission Factor	Dust factor for each duct	kg/t	-	0.86	0.30	-	5.9	4.5	-	2.8	2.3	-	1.3	1.7				
	Dust factor as a boiler	kg/t	1.2		-		10		-		5.1		3.0					
	SO2	kg/t	4.0		-		7.4		-		1.6		1.1					
	NOx	kg/t	1.8		-		6.9		-		0.67		0.88					
	CO	kg/t	1.1		-		0.6		-		0.2		0.021					
Emission Concentration after O2 conversion at 6%	Dust	g/Nm3	0.23				0.61				3.3				1.4			
	SO2	ppm	268				152				371				173			
	NOx	ppm	265				303				324				307			
	CO	ppm	174				27				115				7.8			
Emission Standard Value (MNS)	Dust	g/Nm3	1.2				21				10.8				10.8			
	SO2	ppm	215.3				676.1				519.8				519.8			
	NOx	ppm	238.9				948.3				821.3				821.3			
	CO	ppm	4996				2838				240				240			
Remarks			Fluidized bed furnace															

* Molecular weight of NO is used for converting the NOx unit from ppm to mg/m3

[H-R-1] GER measurement result

Measurement Date			28-Dec-11				29-Dec-11						30-Dec-11			
General information	Place		Obi's ger				Obi's ger						Obi's ger			
	Type of boiler		traditional ger stove				traditional ger stove						turky ger stove			
	Capacity	MW	-				-						-			
	Cross sectional area of duct	m2	0.0095				0.0095						0.0133			
	Type of coal		wood only				wood+Nalaikh coal						wood only			
Operational condition	Velocity of flue gas	m/s	2.9	4.4	3.0		2.7	2.8	3.6	2.5	3.0	2.3	2.1	4.4	3.0	
	Temperature of flue gas	℃	191	271	85		176	195	299	221	207	120	168	350	116	
	Water vapor concentration	%	4.7				5.3						5.9			
	Flow rate of wet flue gas	Nm3/h	50	64	65		39	46	49	40	50	47	53	79	86	
	Flow rate of dry flue gas	Nm3/h	47	58	64		37	42	44	38	50	47	51	71	85	
	Ave. flow rate of dry flue gas	Nm3/h	58				45						75			
	Fuel feed rate	kg/h	2.5 (Wood)				1.7 (Coal)						1.2 (Wood)			
	O2 concentration	%	20.1				17.2						19.0			
	CO2 concentration	%	1.0				3.1						1.7			
CO concentration	ppm	740				1782						1340				
Measured concentration (Raw data)	Dust concentration	g/Nm3	0.23	0.18	0.037		0.00055	0.81	0.035	0.043	0.14	0.000	0.000	0.323	0.000	
	Average dust concentration	g/Nm3	0.11				0.17						0.17			
	SO2 (ppm)	ppm	0.2				17						6.1			
	NOx (ppm)	ppm	1.2				30						6.4			

Emission Factor	Dust	kg/t	2.6				4.4						11			
	SO2	kg/t	0.012				1.2						1.1			
	NOx *	kg/t	0.039				1.1						0.55			
	CO	kg/t	21.5				58						107			
Dust sampling method																

* NO molecular weight is used for converting the NOx unit from ppm to mg/m3

Emission Concentration after O2 conversion at 9.33%	Dust	g/Nm3	1.3				0.53						0.98			
	SO2	ppm	1.8				55						22			
	NOx	ppm	10				87						24			
	CO	ppm	6732				6688						4997			
Emission Standard Value (MNS)	Dust	g/Nm3	2.5				2.5						2.5			
	SO2	ppm	-				-						-			
	NOx	ppm	-				-						-			
	CO	ppm	3200				3200						3200			

[H-R-1] GER measurement result

Measurement Date		31-Dec-11					5-Feb-12					6-Feb-12				
General information	Place	Obi's ger					Mr. Davaajargal Home					Mr. Davaajargal Ger				
	Type of boiler	turky ger stove					Wall stove					Ger stove (Coal)				
	Capacity	-					-					-				
	Cross sectional area of duct	0.0133					0.0532					0.0079				
	Type of coal	wood+Nalaikh coal					Nalaikh					Nalaikh				
Operational condition	Velocity of flue gas	2.4	2.6	2.6	0.5		0.21	0.6	0.3		4.5	5.7	3.1			
	Temperature of flue gas	213	145	130	76		94	101	106		276	469	252			
	Water vapor concentration	5.0					1.4					7.8				
	Flow rate of wet flue gas	54	68	70	16		26	70	35		55	51	39			
	Flow rate of dry flue gas	54	68	70	16		25	69	35		51	47	36			
	Ave. flow rate of dry flue gas	56					38					45				
	Fuel feed rate	2.2 (Coal)					2.0 (Coal)					2.3 (Coal)				
	O2 concentration	17.1					18.9					14.0				
	CO2 concentration	3.1					1.8					5.9				
	CO concentration	1427					2490					3014				
Measured concentration (Raw data)	Dust concentration	0.29	0.13	0.11	0.00		0.42	0.57	0.49		0.54	0.064	0.0028			
	Average dust concentration	0.13					0.50					0.23				
	SO2 (ppm)	45					109					131				
	NOx (ppm)	27					23					29				

Emission Factor	Dust	3.3					9.8					4.4				
	SO2	3.3					6.1					7.3				
	NOx *	0.94					0.61					0.76				
	CO	46					60.4					73.4				
Dust sampling method		Constant flow rate sampling					Constant flow rate sampling									

* NO molecular weight is used for convert the NOx unit from ppm to mg/m3

Emission Concentration after O2 conversion at 9.33%	Dust	0.38					2.8					0.38				
	SO2	154					630					204				
	NOx	64					131					40				
	CO	5606					14048					7193				
Emission Standard Value (MNS)	Dust	2.5					2.5					2.5				
	SO2	-					-					-				
	NOx	-					-					-				
	CO	3200					3200					3200				

[H-R-1] GER measurement result

Measurement Date		6-Feb-12			
General information	Place	Mr. Davaajargal Ger			
	Type of boiler	Ger stove (Semi-Coke)			
	Capacity	-			
	Cross sectional area of duct	0.0079			
	Type of coal	Nalaikh			
Operational condition	Velocity of flue gas	4.0	2.8	3.3	
	Temperature of flue gas	246	237	158	
	Water vapor concentration	1.9			
	Flow rate of wet flue gas	51	36	51	
	Flow rate of dry flue gas	50	35	50	
	Ave. flow rate of dry flue gas	45			
	Fuel feed rate	1.0 (Semi-Coke)			
	O2 concentration	18.6			
	CO2 concentration	2.1			
	CO concentration	4430			
Measured concentration (Raw data)	Dust concentration	0.035	0.013	0.0044	
	Average dust concentration	0.018			
	SO2 (ppm)	22			
	NOx (ppm)	5.3			

Emission Factor	Dust	0.79			
	SO2	2.7			
	NOx *	0.31			
	CO	244			
Dust sampling method		Constant flow rate sampling			

* NO molecular weight is used for convert the NOx unit from ppm to mg/m3

Emission Concentration after O2 conversion at 9.33%	Dust	0.088			
	SO2	110			
	NOx	25			
	CO	18932			
Emission Standard Value (MNS)	Dust	2.5			
	SO2	-			
	NOx	-			
	CO	3200			

[H-R-1] HOB measurement result

Measurement Date		15-Jan-13				16-Jan-13				31-Jan-13					
General information	Place	#76 School				#20 Kindergarten				#104 school					
	Type of boiler	DZL-1.4				DZL-0.7				SHG 0.7					
	Capacity	MW	1.4				0.70				0.35				
	Cross sectional area of duct	m2	0.11				0.16				0.032				
	Type of coal	Nalaikh				Nalaikh				Nalaikh					
Operational condition	Velocity of flue gas	m/s	13.8	11.6	13.0		0.9	0.8	2.0		22.2	21.6	20.3	9.0	
	Temperature of flue gas	°C	119	117	118		58	53	56		129	132	146	100	
	Water vapor concentration	%	13.9				7.8				8.4				
	Flow rate of wet flue gas	Nm3/h	3062	2588	2898		393	392	836		1561	1508	1369	681	
	Flow rate of wet flue gas	Nm3/h	3060	2590	2900		390	390	840		1560	1510	1370	680	
	Flow rate of dry flue gas	Nm3/h	2637	2229	2496		362	361	770		1457	1407	1278	636	
	Flow rate of dry flue gas	Nm3/h	2640	2230	2500		360	360	770		1460	1410	1280	640	
	Ave. flow rate of dry flue gas	Nm3/h	2,454				498				1,194				
	Coal feed rate	kg/h	275				186				64				
	O2 concentration	%	10.6				12.6				16.3				
	CO2 concentration	%	9.5				7.9				4.5				
CO concentration	ppm	50				711				196					
Measured concentration	Dust concentration	g/Nm3	0.55	0.52	0.62		0.030	0.014	0.0028		0.031	0.045	0.044	0.12	
	Average dust concentration	g/Nm3	0.56				0.012				0.050				
(Raw data)	SO2 (ppm)	ppm	625				81				274				
	NOx (ppm)	ppm	155				87				47				

Галлагааны үед салхилуурын шифрийг тохируулсан

Emission Factor	Dust	kg/t	5.0				0.032				0.93			
	SO2	kg/t	16				0.62				14.6			
	NOx *	kg/t	1.9				0.31				1.2			
	CO	kg/t	0.56				2.4				4.6			
Dust sampling method			Isokinetic sampling				Isokinetic sampling				Isokinetic sampling			

Өндөр үзүүлэлтэй гарсан

* NO molecular weight is used for converting the NOx unit from ppm to mg/m3

Emission Concentration after O2 conversion at 9.33%	Dust	g/Nm3	0.62				0.016				0.12			
	SO2	ppm	700				107				684			
	NOx	ppm	172				115				111			
	CO	ppm	60				1237				669			
Emission Standard Value (MNS)	Dust	g/Nm3	0.3				0.4				0.4			
	SO2	ppm	210				280				280			
	NOx	ppm	299				336				336			
	CO	ppm	1600				2000				2000			

[H-R-1] GER measurement result

Measurement Date		9-Oct-12				9-Oct-12				25-Oct-12				25-Oct-12				
General information	Place	Daba's ger				Daba's ger				Daba's ger				Daba's ger				
	Type of boiler	traditional ger stove				traditional ger stove				traditional ger stove				traditional ger stove				
	Capacity	MW	-				-				-				-			
	Cross sectional area of duct	m2	0.0079				0.0079				0.0079				0.0079			
	Type of coal		wood briquet				semicoke				wood briquet B				semicoke briquet			
Operational condition	Velocity of flue gas	m/s	5.0	5.1	4.0		4.5	4.8			3.6	2.0			2.8	2.0		
	Temperature of flue gas	°C	431	477	313		402	435			389	207			257	146		
	Water vapor concentration	%	13.9				17.6				10.4				3.5			
	Flow rate of wet flue gas	Nm3/h	47	44	44		44	44			47	61			77	68		
	Flow rate of dry flue gas	Nm3/h	40	38	38		36	36			42	55			74	66		
	Ave. flow rate of dry flue gas	Nm3/h	39				36				48				70			
	Fuel feed rate	kg/h	3.1 (Wood B.)				2.1 (Semi-Coke)				2.8 (Wood B.)				2.4 (Semi-Coke)			
	O2 concentration	%	13.9				14.8				16.5				18.5			
	CO2 concentration	%	6.5				5.8				4.2				2.5			
	CO concentration	ppm	12533				2877				4319				1508			
Measured concentration (Raw data)	Dust concentration	g/Nm3	0.96	0.04	0.02		0.61	0.02			0.38	0.01			0.15	0.03		
	Average dust concentration	g/Nm3	0.35				0.32				0.17				0.09			
	SO2 (ppm)	ppm	226				67				66				46			
	NOx (ppm)	ppm	24				46				23				14			

Emission Factor	Dust	kg/t	4.4				5.4				3.0				2.7			
	SO2	kg/t	8.1				3.3				3.3				3.9			
	NOx *	kg/t	0.40				1.05				0.55				0.56			
	CO	kg/t	195				62				94				56			
Dust sampling method																		

* NO molecular weight is used for converting the NOx unit from ppm to mg/m3

Emission Concentration after O2 conversion at 9.33%	Dust	g/Nm3	0.58				0.59				0.45				0.43			
	SO2	ppm	252				125				115				280			
	NOx	ppm	42				78				70				57			
	CO	ppm	14938				10516				7646				8757			
Emission Standard Value (MNS)	Dust	g/Nm3	2.5				2.5				2.5				2.5			
	SO2	ppm	-				-				-				-			
	NOx	ppm	-				-				-				-			
	CO	ppm	3200				3200				3200				3200			

[H-R-1] GER measurement result

Measurement Date		23-Jan-13				24-Jan-13				25-Jan-13				24-Jan-13				28-Jan-13			
General information	Place	Otgonbayal's ger				Otgonbayal's ger				Otgonbayal's ger				Otgonbayal's ger				Otgonbayal's ger			
	Type of boiler	traditional ger stove				t traditional ger stove				tradiional				traditional ger stove				traditional ger stove			
	Capacity	-				-				-				-				-			
	Cross sectional area of duct	0.0079				0.0079				0.0079				0.0079				0.0079			
	Type of coal	Wood briquet (Tunkhel)				Wood briquet (Hyalgant)				wood briquet (2-step loan)				semicoke (PP2)				semi coke briquet(MAK)			
Operational condition	Velocity of flue gas	3.0	3.0	3.0		2.5	2.5	3.0		4.0	3.5			3.5	3.0	2.8		2.2	2.3	2.1	2.5
	Temperature of flue gas	200	200	200		207	230	387		443	340			239	266	235		128	140	134	149
	Water vapor concentration	6.1				9.6				5.4				2.4				4.2			
	Flow rate of wet flue gas	42	42	42		34	33	28		37	36			45	36	36		36	35	33	38
	Flow rate of dry flue gas	36	40	41		32	31	26		35	34			44	35	35		34	34	32	36
	Ave. flow rate of dry flue gas	39				30				34				38				35			
	Fuel feed rate	2.0 (Wood B.)				2.8 (Wood B.)				2.0 (Wood B.)				1.0 (Semi-Coke)				1.0 (Semi-Coke)			
	O2 concentration	17.9				15.7				17.5				18.1				18.7			
	CO2 concentration	2.9				4.4				2.8				2.2				2.1			
	CO concentration	2435				2425				1513				3244				2350			
Measured concentration (Raw data)	Dust concentration	0.35	0.11	0.29		0.10	0.082	0.10		0.072	0.051			0.0053	0.0013	0.0017		0.071	0.072	0.070	0.0093
	Average dust concentration	0.21				0.095				0.056				0.0029				0.029			
	SO2 (ppm)	21				14				7.2				1.5				16			
	NOx (ppm)	16				25				13				9.4				12			

Emission Factor	Dust	4.1				1.0				0.97				0.11				1.0			
	SO2	1.2				0.42				0.36				0.16				1.6			
	NOx *	0.43				0.35				0.31				0.47				0.59			
	CO	60				32				33				152				104			
Dust sampling method		Constant flow rate sampling				Isokinetic sampling				Isokinetic sampling				Isokinetic sampling				Isokinetic sampling			

* NO molecular weight is used for conve

Emission Concentration after O2 conversion at 9.33%	Dust	0.78				0.21				0.19				0.011				0.15			
	SO2	71				22				29				5.1				83			
	NOx	63				54				46				35				64			
	CO	9191				5930				5966				15203				12161			
Emission Standard Value (MNS)	Dust	2.5				2.5				2.5				2.5				2.5			
	SO2	-				-				-				-				-			
	NOx	-				-				-				-				-			
	CO	3200				3200				3200				3200				3200			

[H-R-1] GER measurement result

Шаталт тогтуун явагдах үед

Эрчимт галлагааны үед

Measurement Date		21-Jan-13				22-Jan-13					28-Jan-13				29-Jan-13			
General information	Place	Otgonbayal's ger				Otgonbayal's ger					Otgonbayal's ger				Otgonbayal's ger			
	Type of boiler	turky ger stove coal1				turky ger stove coal2					traditional ger stove				traditional ger stove			
	Capacity	MW	-				-					-				-		
	Cross sectional area of duct	m ²	0.013				0.013					0.0079				0.0079		
	Type of coal	Nalaikh				Nalaikh					Nalaikh				Nalaikh			
Operational condition	Velocity of flue gas	m/s	0.7~1.4	0.7~1.4	0.7~1.4	1~2	1~2	1~2	1~2	1~2	3.3	3.7	2.5		2.5	2.6	1.9	
	Temperature of flue gas	°C	255	348	255	513	525	469	373	312	205	227	197		161	213	134	
	Water vapor concentration	%	13.3				10.9					3.0				2.9		
	Flow rate of wet flue gas	Nm ³ /h	15	13	15	14	14	15	17	19	44	48	34		37	35	30	
	Flow rate of dry flue gas	Nm ³ /h	13	11	13	13	13	13	15	17	43	47	33		36	34	29	
	Ave. flow rate of dry flue gas	Nm ³ /h	13				14					36				30		
	Fuel feed rate	kg/h	1.8				1.8					1.6				1.6		
	O ₂ concentration	%	15.0				14.7					17.3				16.3		
	CO ₂ concentration	%	4.8				5.4					3.2				3.9		
	CO concentration	ppm	1060				285					2230				4292		
Measured concentration (Raw data)	Dust concentration	g/Nm ³	0.018	0.021	0.0042	0.034	0.016	0.022	0.032	0.040	0.14	0.024	0.042		0.099	0.21	0.022	
	Average dust concentration	g/Nm ³	0.0062				0.029					0.055				0.061		
	SO ₂ (ppm)	ppm	131				117					36				71		
	NO _x (ppm)	ppm	69				57					41				45		

Emission Factor	Dust	kg/t	0.043 ~ 0.085				0.23 ~ 0.45					1.2				1.2		
	SO ₂	kg/t	2.6 ~ 5.2				2.6 ~ 5.2					2.3				3.9		
	NO _x *	kg/t	0.63 ~ 1.3				0.59 ~ 1.2					1.2				1.2		
	CO	kg/t	9.1 ~ 18				2.8 ~ 5.6					63				103		
Dust sampling method			Constant flow rate sampling				Constant flow rate sampling					Isokinetic sampling				Isokinetic sampling		

* NO molecular weight is used for converting the NO_x unit from ppm to mg/m³

Emission Concentration after O ₂ conversion at 9.33%	Dust	g/Nm ³	0.012				0.054					0.17				0.15		
	SO ₂	ppm	254				207					104				186		
	NO _x	ppm	137				98					125				110		
	CO	ppm	1962				565					7298				11491		
Emission Standard Value (MNS)	Dust	g/Nm ³	2.5				2.5					2.5				2.5		
	SO ₂	ppm	-				-					-				-		
	NO _x	ppm	-				-					-				-		
	CO	ppm	3200				3200					3200				3200		